

UTC HE8050 NPN EPITAXIAL SILICON TRANSISTOR

LOW VOLTAGE HIGH CURRENT SMALL SIGNAL NPN TRANSISTOR

DESCRIPTION

The UTC HE8050 is a low voltage high current small signal NPN transistor, designed for Class B push-pull 2W audio amplifier for portable radio and general purpose applications.

FEATURES

- *Collector current up to 1.5A
- *Collector-Emitter voltage up to 25 V
- *complimentary to UTC HE8550

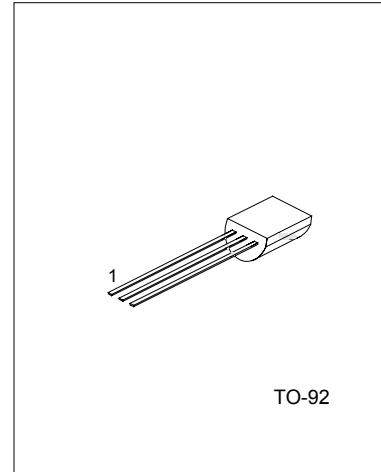

1:EMITTER 2:COLLECTOR 3: BASE

ABSOLUTE MAXIMUM RATINGS (Ta=25°C, unless otherwise specified)

PARAMETER	SYMBOL	VALUE	UNIT
Collector-Base Voltage	V _{CB0}	40	V
Collector-Emitter Voltage	V _{CEO}	25	V
Emitter-Base Voltage	V _{EBO}	6	V
Collector Dissipation(Ta=25°C)	P _c	1	W
Collector Current	I _c	1.5	A
Junction Temperature	T _j	150	°C
Storage Temperature	T _{STG}	-65 ~ +150	°C

ELECTRICAL CHARACTERISTICS (Ta=25°C, unless otherwise specified)

Parameter	Symbol	Test conditions	MIN	TYP	MAX	UNIT
Collector-Base Breakdown Voltage	V _{CB0}	I _c =100μA, I _E =0	40			V
Collector-Emitter Breakdown Voltage	V _{CEO}	I _c =2mA, I _B =0	25			V
Emitter-Base Breakdown Voltage	V _{EBO}	I _E =100μA, I _c =0	6			V
Collector Cut-Off Current	I _{CB0}	V _{CB} =35V, I _E =0			100	nA
Emitter Cut-Off Current	I _{EBO}	V _{EB} =6V, I _c =0			100	nA
DC Current Gain	h _{FE1}	V _{CE} =1V, I _c =5mA	45	135		
	h _{FE2}	V _{CE} =1V, I _c =100mA	85	160	500	
	h _{FE3}	V _{CE} =1V, I _c =800mA	40	110		
Collector-Emitter Saturation Voltage	V _{CE(sat)}	I _c =800mA, I _B =80mA			0.5	V
Base-Emitter Saturation Voltage	V _{BE(sat)}	I _c =800mA, I _B =80mA			1.2	V
Base-Emitter Saturation Voltage	V _{BE}	V _{CE} =1V, I _c =10mA			1.0	V
Current Gain Bandwidth Product	f _T	V _{CE} =10V, I _c =50mA	100			MHz
Output Capacitance	C _{ob}	V _{CB} =10V, I _E =0 f=1MHz		9.0		pF

UTC UNISONIC TECHNOLOGIES CO., LTD. 1

QW-R201-009,A

UTC HE8050 NPN EPITAXIAL SILICON TRANSISTOR

CLASSIFICATION OF hFE

RANK	C	D	E
RANGE	120-200	160-300	250-500

TYPICAL PERFORMANCE CHARACTERISTICS

www.DataSheet4U.com

Fig.1 Static characteristics

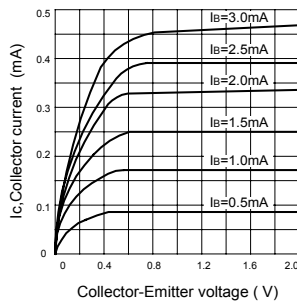

Fig.2 DC current Gain

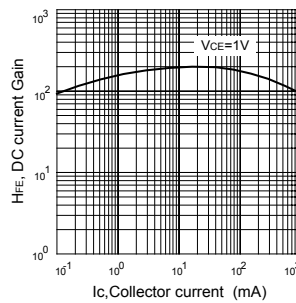

Fig.3 Base-Emitter on Voltage

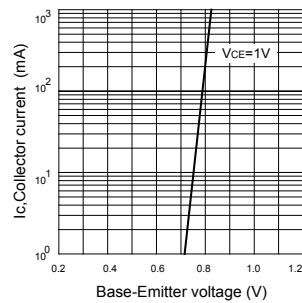

Fig.4 Saturation voltage

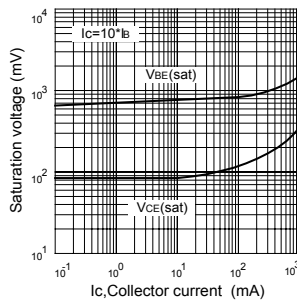

Fig.5 Current gain-bandwidth product

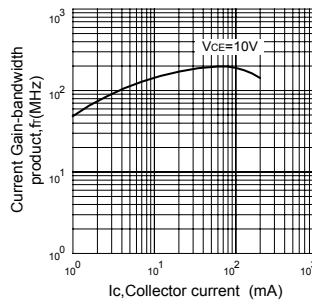
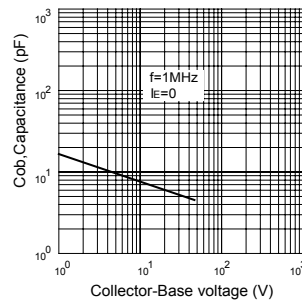

Fig.6 Collector output Capacitance



UTC assumes no responsibility for equipment failures that result from using products at values that exceed, even momentarily, rated values (such as maximum ratings, operating condition ranges, or other parameters) listed in products specifications of any and all UTC products described or contained herein. UTC products are not designed for use in life support appliances, devices or systems where malfunction of these products can be reasonably expected to result in personal injury. Reproduction in whole or in part is prohibited without the prior written consent of the copyright owner. The information presented in this document does not form part of any quotation or contract, is believed to be accurate and reliable and may be changed without notice.