

# RECTIFIERS

## Super-Fast Recovery, 1 Amp and 2 Amp

UTX105-UTX125  
UTX205-UTX225

2

### FEATURES

- Continuous Rating: to 2A
- Controlled Avalanche
- Surge: to 25A
- Recovery Time less than 75ns
- Miniature Package

### DESCRIPTION

These miniature super-fast recovery rectifiers permit operation at full power at frequencies as high as 100kHz square wave. They may be used as half wave rectifiers or as legs of a bridge.

### ABSOLUTE MAXIMUM RATINGS

Peak Inverse Voltage	1 Amp Series	2 Amp Series
50V	UTX105	UTX205
100V	UTX110	UTX210
150V	UTX115	UTX215
200V	UTX120	UTX220
250V	UTX125	UTX225

	1 AMP SERIES	2 AMP SERIES
Maximum Average D.C. Output Current		
@ $T_A = 25^\circ\text{C}$	1.0A	2.0A
@ $T_A = 100^\circ\text{C}$	0.5A	1.0A
Non-Repetitive Sinusoidal		
Surge Current (8.3ms)	20A	25A
Operating Temperature Range	-195°C to +175°C	
Storage Temperature Range	-195°C to +200°C	
Thermal Resistance	See Lead Temperature Derating Curve	

### MECHANICAL SPECIFICATIONS

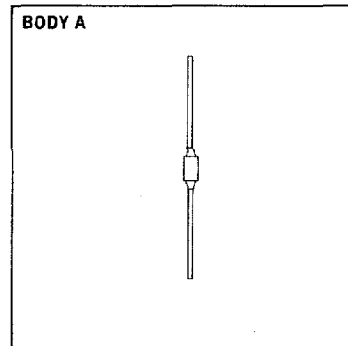
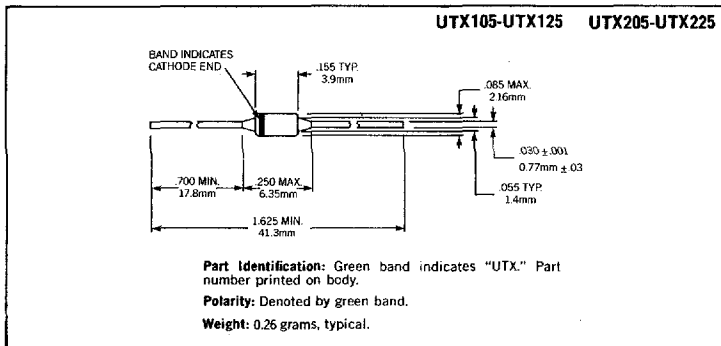

**ELECTRICAL SPECIFICATIONS (at 25°C unless noted)**

Type	PIV	Maximum Voltage Forward Drop	Leakage Current @ PIV		Max. Reverse Recovery Time*
			25°C	100°C	
UTX 205 UTX 210 UTX 215 UTX 220 UTX 225	50V 100V 150V 200V 250V	1.0V @ 1 Adc	3μA	50μA	75ns
UTX 105 UTX 110 UTX 115 UTX 120 UTX 125	50V 100V 150V 200V 250V	1.0V @ 0.5 Adc	3μA	50μA	75ns

\*Recovery time is measured from 10.0mA to 10.0mA recovery to 5.0mA.

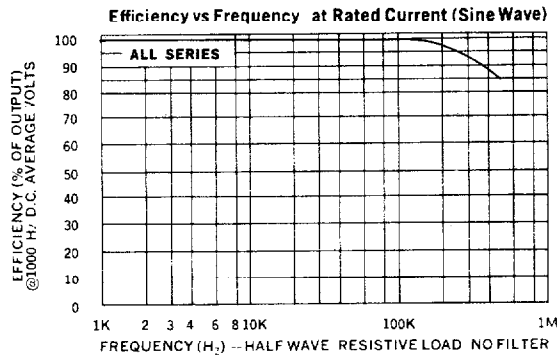
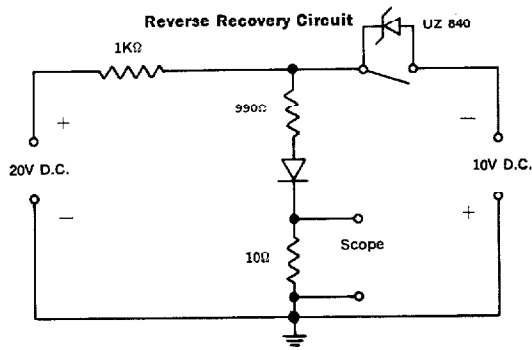
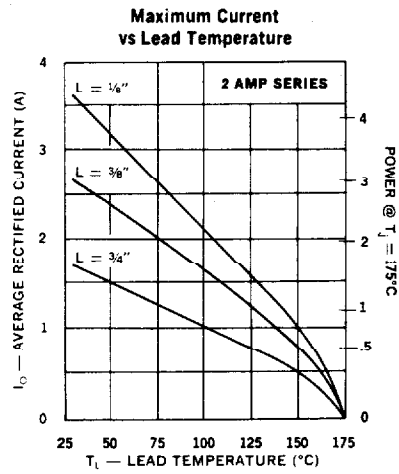
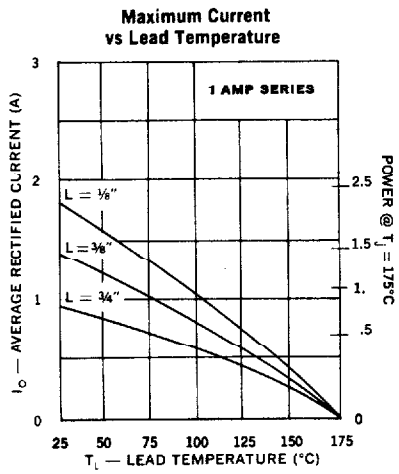

Typical Leakage Current vs. PIV

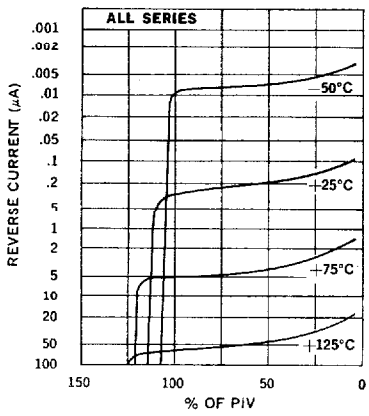

Typical Forward Current vs Forward Voltage

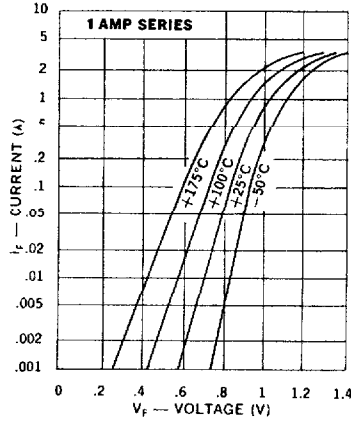

Typical Forward Current vs Forward Voltage

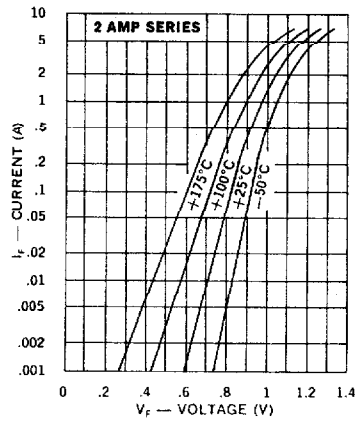

Forward Pulse Current vs Pulse Duration

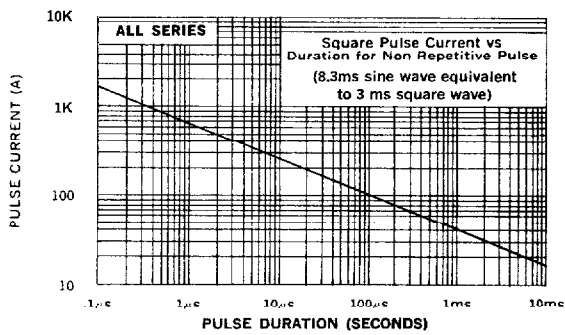

Reverse Pulse Power vs Pulse Duration

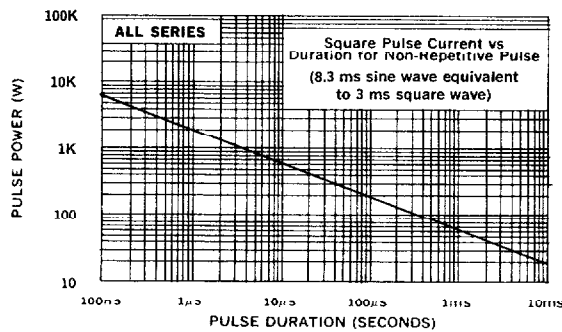

Allowable Forward Surge vs Number of Cycles

