

# C-III Series

## Radial Leaded Varistors



### Description

The C-III Varistor Series of Metal-Oxide Varistors (MOVs) are specifically designed for applications requiring high surge energy absorption ratings and superior multiple pulse absorption rating. This is achieved through a special dielectric material formulation which also results in higher repetitive surge ratings than other MOV types.

The C-III Varistor Series is primarily intended for use in AC line Surge Protection Device (SPD) product and other similar applications requiring high transient energy and peak current capability in a relatively small package size.

### Features & Benefits

- Lead-free, Halogen-Free and RoHS compliant
- High energy absorption capability WTM 40J to 530J (2ms)
- High pulse life rating
- High peak pulse current capability
- ITM 3500A to 10,000A (8/20 $\mu$ s)
- Wide operating voltage range VM(AC)RMS 130V to 1000V
- Available in tape and reel for automatic insertion; Also available with crimped and/or trimmed lead styles
- No derating up to 85°C ambient
- The C-III Series is supplied in 10mm, 14mm and 20mm disc versions with various lead options

### Additional Information



Resources



Accessories



Samples

### Agency Approvals

Agency	Agency Approval	Agency File Number
	UL1449	E320116
	CECC 42201-006 IEC 61051-1 IEC 61051-2 IEC 60950-1 (Annex Q) for 14mm and 20mm only	116895
	CECC 42201-006 IEC 61051-1 IEC 61051-2 IEC 60950-1 (Annex Q) for 14mm and 20mm only	E1273/F

### Absolute Maximum Ratings

For ratings of individual members of a series, see Device Ratings and Specifications chart

Continuous	C-III Series	Units
<b>Steady State Applied Voltage</b>		
AC Voltage Range ( $V_{M(AC)RMS}$ )	130 to 1000	V
<b>Transients</b>		
Single-Pulse Peak Current ( $I_{TM}$ ) 8/20 $\mu$ s Wave (See Peak Pulse Current Test Waveform)	3500 to 10,000	A
Single-Pulse Energy Range ( $W_{TM}$ ) 2ms Rectangular Wave	40 to 530	J
Operating Ambient Temperature Range ( $T_A$ )	-55 to +85	°C
Storage Temperature Range ( $T_{STG}$ )	-55 to +125	°C
Temperature Coefficient ( $\alpha^V$ ) of Clamping Voltage ( $V_C$ ) at Specified Test Current	<0.01	%/°C
Hi-Pot Encapsulation (COATING Isolation Voltage Capability)	2500	V
COATING Insulation Resistance	1000	M $\Omega$

**Caution:** Stresses above those listed in "Absolute Maximum Ratings" may cause permanent damage to the device. This is a stress only rating and operation of the device at these or any other conditions above those indicated in the operational sections of this specification is not implied.

# C-III Series

## Radial Leaded Varistors

### C-III Series Ratings

Part Number	Branding	Disc Size (mm)	Maximum Ratings (85 °C)					Specifications (25 °C)						
			Continuous		Transient			Varistor Voltage at 1mA DC Test Current		Maximum Clamping Voltage (8/20µs)		Duty Cycle Surge Rating		
			Maximum $V_{RMS}$ $V_{M(AC)}$ (V)	Withstanding Energy (2ms) $W_{TM}$ (J)	Peak Current (8/20µs)									
					$I_{TM1}$ 1 Pulse (A)	$I_{TM2}$ 2 Pulses (A)	$V_N$ Min (V)	$V_N$ Max (V)	$V_C$ (V)	$I_P$ (A)	3kA (8/20µs) # Pulses	750A (8/20µs) # Pulses		
V130LA5CP	P130L5C	10	130	40	3500	3000	184.5	225.5	340	25	2	20		
V130LA10CP	P130L10C	14	130	80	6500	5000	184.5	225.5	340	50	15	80		
V130LA20CP	P130L20C	20	130	200	10000	7000	184.5	225.5	340	100	20	120		
V130LA20CPX325	P130X325	20	130	200	10000	7000	190	220	325	100	20	120		
V140LA5CP	P140L5C	10	140	45	3500	3000	198	242	360	25	2	20		
V140LA10CP	P140L10C	14	140	90	6500	5000	198	242	360	50	15	80		
V140LA20CP	P140L20C	20	140	210	10000	7000	198	242	360	100	20	120		
V140LA20CPX340	P140X340	20	140	210	10000	7000	198	230	340	100	20	120		
V150LA5CP	P150L5C	10	150	50	3500	3000	216.0	264.0	395	25	2	20		
V150LA10CP	P150L10C	14	150	100	6500	5000	216.0	264.0	395	50	15	80		
V150LA20CP	P150L20C	20	150	215	10000	7000	216.0	264.0	395	100	20	120		
V150LA20CPX360	P150X360	20	150	215	10000	7000	216	243	360	100	20	120		
V175LA5CP	P175L5C	10	175	55	3500	3000	243	297	455	25	2	20		
V175LA10CP	P175L10C	14	175	110	6500	5000	243	297	455	50	15	80		
V175LA20CP	P175L20C	20	175	220	10000	7000	243	297	455	100	20	120		
V175LA20CPX425	P175X425	20	175	220	10000	7000	247	285	425	100	20	120		
V230LA10CP	P230L10C	10	230	60	3500	3000	324	396	595	25	2	20		
V230LA20CP	P230L20C	14	230	125	6500	5000	324	396	595	50	15	80		
V230LA40CP	P230L40C	20	230	280	10000	7000	324	396	595	100	20	120		
V230LA40CPX570	P230X570	20	230	280	10000	7000	324	384	570	100	20	120		
V250LA10CP	P250L10C	10	250	65	3500	3000	351	429	650	25	2	20		
V250LA20CP	P250L20C	14	250	135	6500	5000	351	429	650	50	15	80		
V250LA40CP	P250L40C	20	250	300	10000	7000	351	429	650	100	20	120		
V250LA40CPX620	P250X620	20	250	300	10000	7000	354	413	620	100	20	120		
V275LA10CP	P275L10C	10	275	70	3500	3000	387	473	710	25	2	20		
V275LA20CP	P275L20C	14	275	145	6500	5000	387	473	710	50	15	80		
V275LA40CP	P275L40C	20	275	320	10000	7000	387	473	710	100	20	120		
V275LA40CPX680	P275X680	20	275	320	10000	7000	389	453	680	100	20	120		
V300LA10CP	P300L10C	10	300	75	3500	3000	423.0	517.0	775	25	2	20		
V300LA20CP	P300L20C	14	300	155	6500	5000	423.0	517.0	775	50	15	80		
V300LA40CP	P300L40C	20	300	335	10000	7000	423.0	517.0	775	100	20	120		
V300LA40CPX745	P300X745	20	300	335	10000	7000	420	490	745	100	20	120		
V320LA10CP	P320L10C	10	320	80	3500	3000	462.0	558.0	850	25	2	20		
V320LA20CP	P320L20C	14	320	165	6500	5000	462.0	558.0	850	50	15	80		
V320LA40CP	P320L40C	20	320	345	10000	7000	462.0	558.0	850	100	20	120		
V320LA40CPX810	P320X810	20	320	345	10000	7000	462	540	810	100	20	120		
V385LA10CP	P385L10C	10	385	85	3500	3000	558	682	1025	25	2	20		
V385LA20CP	P385L20C	14	385	175	6500	5000	558	682	1025	50	15	80		
V385LA40CP	P385L40C	20	385	370	10000	7000	558	682	1025	100	20	120		
V420LA10CP	P420L10C	10	420	90	3500	3000	612.0	748.0	1120	25	2	20		
V420LA20CP	P420L20C	14	420	185	6500	5000	612.0	748.0	1120	50	15	80		
V420LA40CP	P420L40C	20	420	390	10000	7000	612.0	748.0	1120	100	20	120		
V460LA10CP	P460L10C	10	460	95	3500	3000	643.5	786.5	1190	25	2	20		
V460LA20CP	P460L20C	14	460	190	6500	5000	643.5	786.5	1190	50	15	80		
V460LA40CP	P460L40C	20	460	430	10000	7000	643.5	786.5	1190	100	20	120		

# C-III Series

## Radial Leaded Varistors

### C-III Series Specifications (continued from previous page)

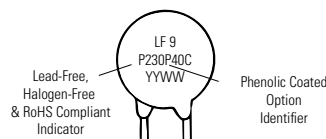
V480LA10CP	P480L10C	10	480	95	3500	3000	675.0	825.0	1240	25	2	20
V480LA40CP	P480L40C	14	480	195	6500	5000	675.0	825.0	1240	50	15	80
V480LA80CP	P480L80C	20	480	420	10000	7000	675.0	825.0	1240	100	20	120
V510LA10CP	P510L10C	10	510	98	3500	3000	738.0	902.0	1350	25	2	20
V510LA40CP	P510L40C	14	510	205	6500	5000	738.0	902.0	1350	50	15	80
V510LA80CP	P510L80C	20	510	440	10000	7000	738.0	902.0	1350	100	20	120
V550LA10CP	P550L10C	10	550	98	3500	3000	792.0	968.0	1435	25	2	20
V550LA40CP	P550L40C	14	550	210	6500	5000	792.0	968.0	1435	50	15	80
V550LA80CP	P550L80C	20	550	450	10000	7000	792.0	968.0	1435	100	20	120
V575LA10CP	P575L10C	10	575	100	3500	3000	819.0	1001.0	1500	25	2	20
V575LA40CP	P575L40C	14	575	230	6500	5000	819.0	1001.0	1500	50	15	80
V575LA80CP	P575L80C	20	575	460	10000	7000	819.0	1001.0	1500	100	20	120
V625LA10CP	P625L10C	10	625	105	3500	3000	900	1100	1650	25	2	20
V625LA40CP	P625L40C	14	625	235	6500	5000	900	1100	1650	50	15	80
V625LA80CP	P625L80C	20	625	490	10000	7000	900	1100	1725	100	20	120
V660LA10CP	P660L10C	10	660	110	3500	3000	972.0	1188.0	1820	25	2	20
V660LA50CP	P660L50C	14	660	240	6500	5000	972.0	1188.0	1820	50	15	80
V660LA80CP	P660L80C	20	660	510	10000	7000	972.0	1188.0	1820	100	20	120
V680LA10CP	P680L10C	10	680	115	3500	3000	990.0	1210.0	1860	25	2	20
V680LA80CP	P680L80C	14	680	240	6500	5000	990	1210	1820	50	15	80
V680LA100CP	P680L100C	20	680	520	10000	7000	990	1130	1700	100	20	120
V1000LA80CP	P1000L8C	14	1000	260	6500	5000	1500	1800	2700	50	15	80
V1000LA160CP	P1000L16C	20	1000	530	10000	7000	1500	1800	2700	100	20	120

**NOTES:**

- Average power dissipation of transients not to exceed 0.6W and 1W for model sizes 14mm and 20mm, respectively.
- 7mm parts also available-contact factory for further information
- For additional or intermediary voltage ratings contact factory

### Phenolic Coating Option -- C-III Series Varistors for Hi-Temperature Operating Conditions:

- Phenolic Coated CIII Series devices are available with improved maximum operating maximum temperature 125°C
- These devices also have improved temperature cycling performance capability.
- Ratings and Specifications are as per standard except Hi-Pot Encapsulation (Isolation Voltage Capability)=500V.
- To order: add X1347 to part number (e.g. V230LA40CPX1347)
- These devices are not UL, CSA, VDE or CECC certified.
- Contact factory for further details.
- Product marking:



# C-III Series

## Radial Leaded Varistors

**Figure 1. Current Energy and Power Dissipation Ratings**

Should transients occur in rapid succession, the average power dissipation is the energy (watt-seconds) per pulse times the number of pulses per second. The power so developed must be within the specifications shown on the Device Ratings and Specifications Table for the specific device. The operating values

of a MOV need to be derated at high temperatures as shown above. Because varistors only dissipate a relatively small amount of average power they are not suitable for repetitive applications that involve substantial amounts of average power dissipation.

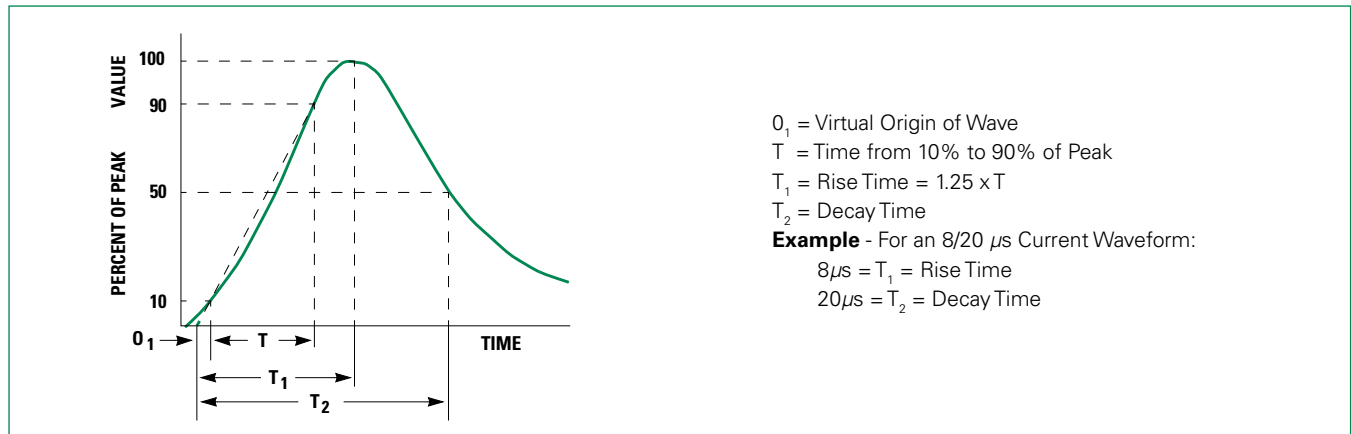
**1A - Power Derating for Epoxy Coated**



**1B - Power Derating for Phenolic Coated**

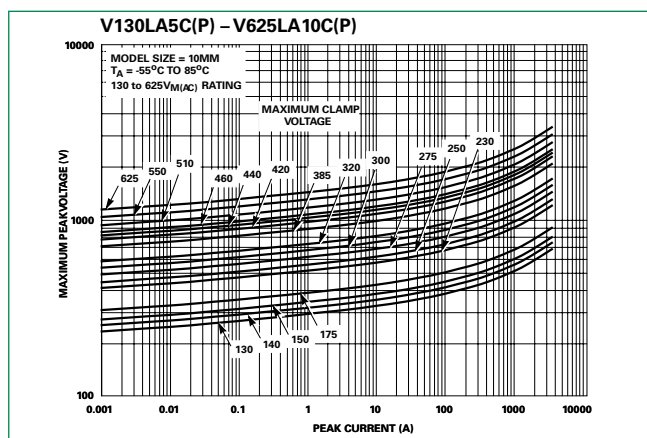


**Figure 2. Peak Pulse Current Test Waveform**



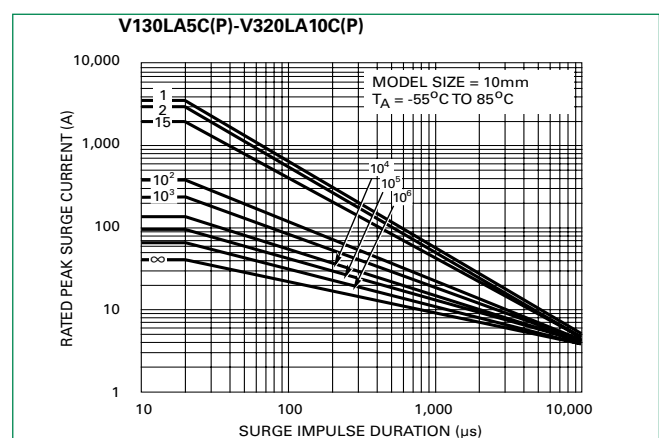
**Transient V-I Characteristics Curves**

**Figure 3. Maximum Clamping Voltage for 10mm Parts**



**Pulse Rating Curves**

**Figure 4. Repetitive Surge Capability for 10mm Parts**



# C-III Series

## Radial Leaded Varistors

### Transient V-I Characteristics Curves

Figure 5. Maximum Clamping Voltage for 14mm Parts



### Pulse Rating Curves

Figure 6. Repetitive Surge Capability for 14mm Parts



Figure 7. Maximum Clamping Voltage for 20mm Parts

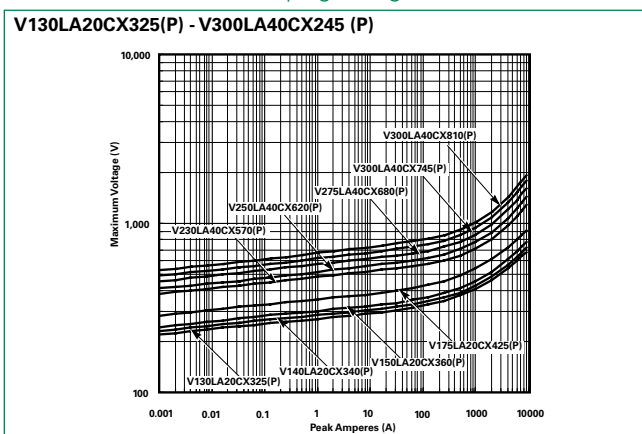


Figure 8. Repetitive Surge Capability for 20mm Parts



Note: Repetitive surge capability is qualified and tested based on 8/20μs current waveform (not combination waveform) and UL1449 40.7.3 (Edition 4) test condition.

Figure 9. Maximum Clamping Voltage for Low Clamping Voltage Parts

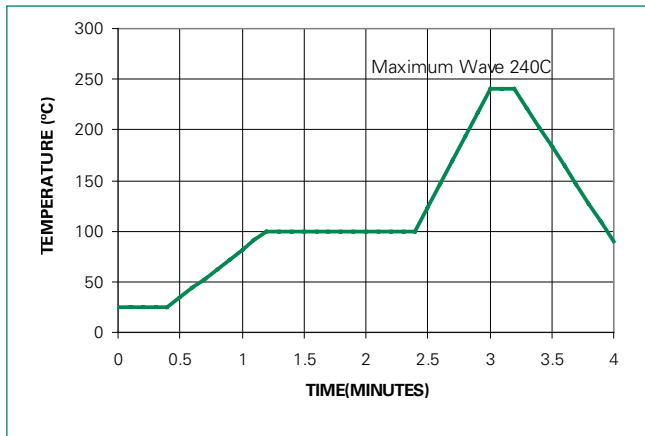


# C-III Series

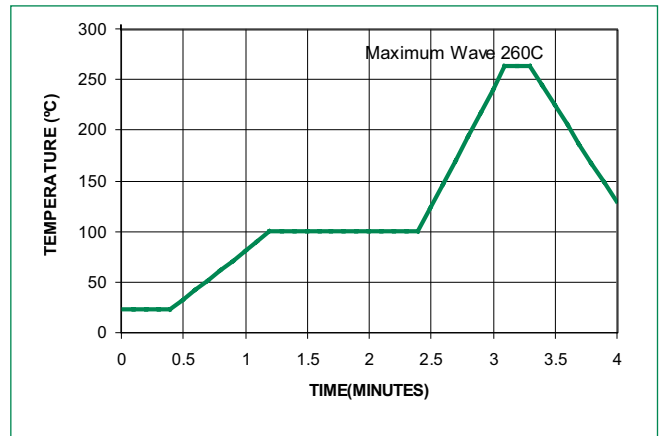
## Radial Leaded Varistors

### Wave Solder Profile

**Figure 10.** Non Lead-free Profile



**Figure 11.** Lead-free Profile



### Physical Specifications

<b>Lead Material</b>	Copper Clad Steel Wire
<b>Soldering Characteristics</b>	Solderability per MIL-STD-202, Method 208
<b>Insulating Material</b>	Cured, flame retardant epoxy polymer meets UL94V-0 requirements
<b>Device Labeling</b>	Marked with LF, voltage, UL/CSA Logos, and date code

### Environmental Specifications

<b>Operating/Storage Temperature</b>	-55°C to +85°C/-55°C to +125°C
<b>Humidity Aging</b>	+85°C, 85% RH, 1000 hours +/-10% typical voltage change
<b>Thermal Shock</b>	+85°C to -40°C, 5 times +/-10% typical voltage change
<b>Solvent Resistance</b>	MIL-STD-202, Method 215
<b>Moisture Sensitivity</b>	Level 1, J-STD-020

# C-III Series

## Radial Leaded Varistors

### AC Bias Reliability

The C-III Series MOVs were designed for use on the AC line. The varistor is connected across the AC line and is biased with a constant amplitude sinusoidal voltage. It should be noted that the definition of failure is a shift in the nominal varistor voltage (VN) exceeding +/-10%. Although this type of varistor is still functioning normally after this magnitude of shift, devices at the lower extremities of VN tolerance will begin to dissipate more power. Because of this possibility, an extensive series of statistically designed tests were performed to determine the reliability of the C-III type of varistor under AC bias combined with high levels of temperature stress. To date, this test has generated over 50,000 device hours of operation at a temperature of 125°C, although only rated at 85°C. Changes in the nominal varistor voltage, measured at 1mA, of less than 2% have been recorded, as displayed in the diagram at right.

Figure 12. High Temperature Operating Life 125°C for 1000 Hours at Rated Bias

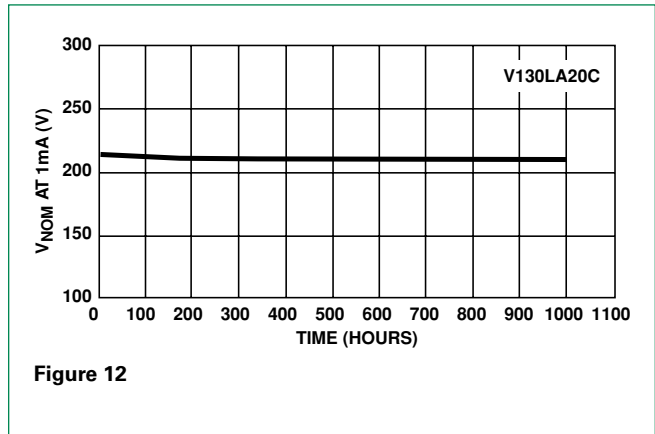


Figure 12

### Transient Surge Current/Energy Transient Capability

The transient surge rating serves as an excellent figure of merit for the C-III varistor. This inherent surge handling capability is one of the C-III varistor's best features. The enhanced surge absorption capability results from improved process uniformity and enhanced construction. The homogeneity of the raw material powder and improved control over the sintering and assembly processes are contributing factors to this improvement.

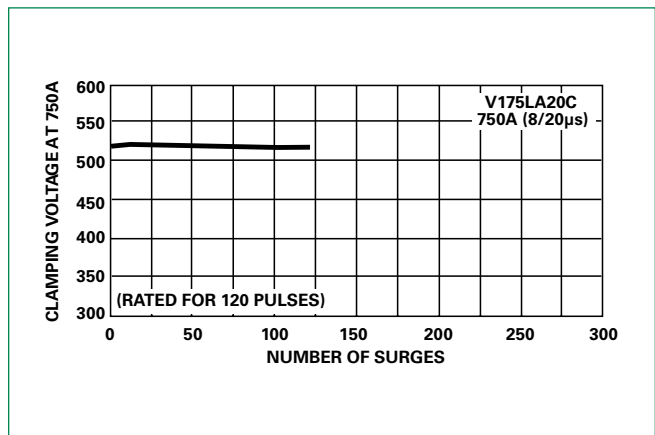
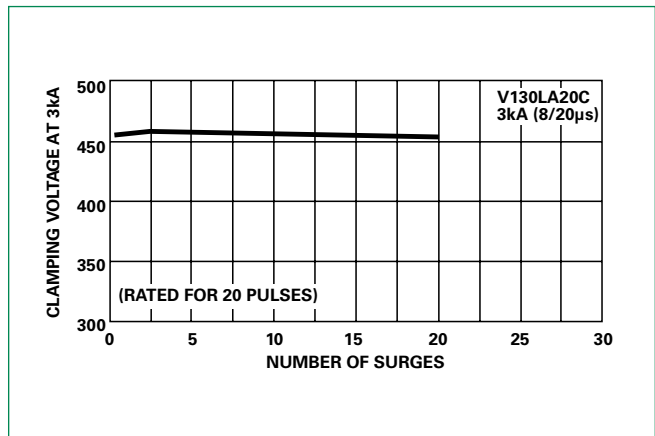
In the low power AC mains environment, industry standards (UL, IEC, NEMA and IEEE) all suggest that the worst case surge occurrence will be 3kA. Such a transient event may occur up to five times over the equipment life time (approximately 10 years). While the occurrences of five 3kA transients is the required capability, the rated, repetitive surge current for the C-III Series is 20 pulses for the 20mm units and 10 pulses for the 14mm Series.

As a measure of the inherent device capability, samples of the 20mm V130LA20C devices were subjected to a worst case repetitive transient surges test. After 20 pulses, each of 3kA, there was negligible change in the device characteristics. Changes in the clamping voltage, measured at 100A, of less than 3% were recorded, as shown in the upper diagram at right.

Samples of the 20mm Series V175LA20C were subjected to repetitive surge occurrences of 750A. Again, there was negligible changes in any of the device characteristics after 120 pulses, as shown in the lower diagram at right.

In both cases the inherent device capability is far in excess of the expected worst case scenario.

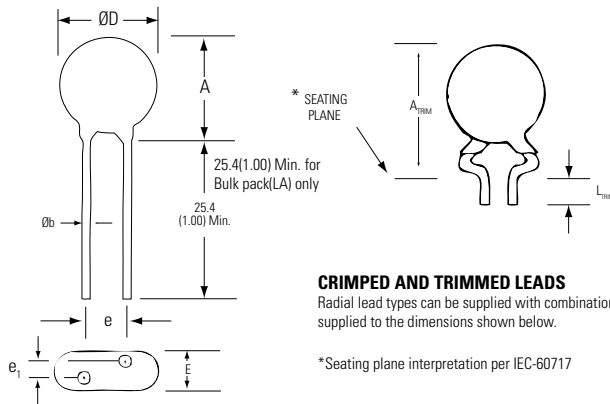
Figure 13 & 14. Typical Repetitive Surge Current Capability of C-III Series MOVs



# C-III Series

## Radial Ledged Varistors

### Product Dimensions (mm)



Dimension	V <sub>RMS</sub> Voltage Model	10mm Size		14mm Size		20mm Size	
		Min.	Max.	Min.	Max.	Min.	Max.
<b>A</b>	All	12.0 (0.472)	16.0 (0.630)	13.5 (0.531)	20.0 (0.787)	17.5 (0.689)	28.0 (1.102)
<b>ØD</b>	All	10.0 (0.394)	12.5 (0.492)	13.5 (0.531)	17.0 (0.669)	17.5 (0.689)	23.0 (0.906)
<b>e</b>	All	6.5 (0.256)	8.5 (0.335)	6.5 (0.256)	8.5 (0.335)	6.5 (0.256)	8.5 (0.335)
<b>e<sub>1</sub></b>	130 - 320	1.5 (0.059)	5.5 (0.216)	1.5 (0.059)	4.5 (0.177)	1.5 (0.059)	4.5 (0.177)
	385 - 680	2.5 (0.098)	7.5 (0.295)	2.5 (0.098)	7.5 (0.295)	2.5 (0.098)	7.5 (0.295)
	> 680	4.5 (0.177)	9.5 (0.374)	4.5 (0.177)	9.5 (0.374)	4.5 (0.177)	9.5 (0.374)
<b>E</b>	130 - 320	-	7.3 (0.287)	-	7.3 (0.287)	-	7.3 (0.287)
	385 - 680	-	11.0 (0.433)	-	11.0 (0.433)	-	11.0 (0.433)
	> 680	-	14.0 (0.551)	-	14.0 (0.551)	-	14.0 (0.551)
<b>Øb</b>	130 - 625	0.76 (0.030)	0.86 (0.034)	0.76 (0.030)	0.86 (0.034)	0.76 (0.030)	0.86 (0.034)
	>625	-	-	-	-	0.95 (0.037)	1.05 (0.041)
<b>A<sub>TRIM</sub></b>	All	-	19.5 (0.768)	-	23.5 (0.925)	-	30.0 (1.18)
<b>L<sub>TRIM</sub></b>	All	2.41 (0.095)	4.69 (0.185)	2.41 (0.095)	4.69 (0.185)	2.41 (0.095)	4.69 (0.185)

**Dimensions are in millimeters (inches)**

- 10mm lead spacing also available. See additional lead style options.
- 7mm and 12mm devices also available upon request. Contact factory for details.
- 1000V parts supplied with lead wire of diameter 1.00 +/- 0.05 (0.039 +/- 0.002).



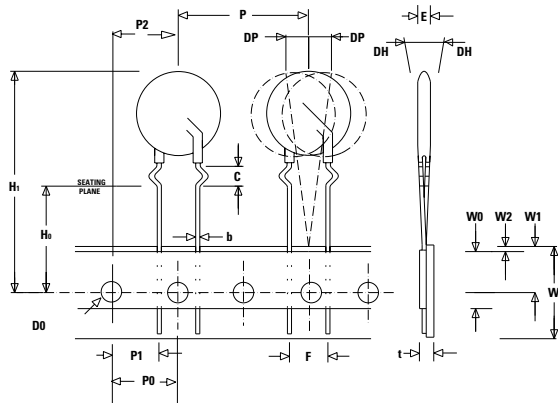
# C-III Series

## Radial Leaded Varistors

### Tape and Reel Specifications

- (available for voltage ratings up to 550V only)

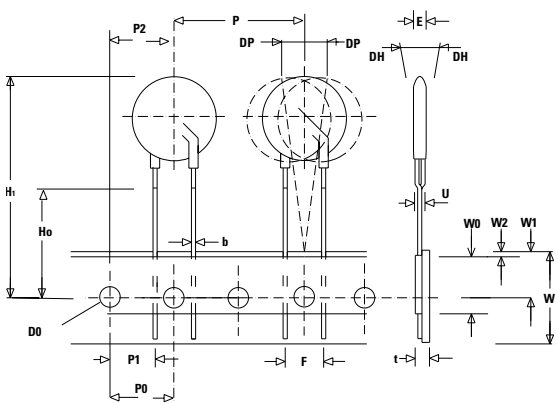
CRIMPED LEADS "LT"



STRAIGHT LEADS "LS"



UNDER-CRIMPED LEADS "LU"

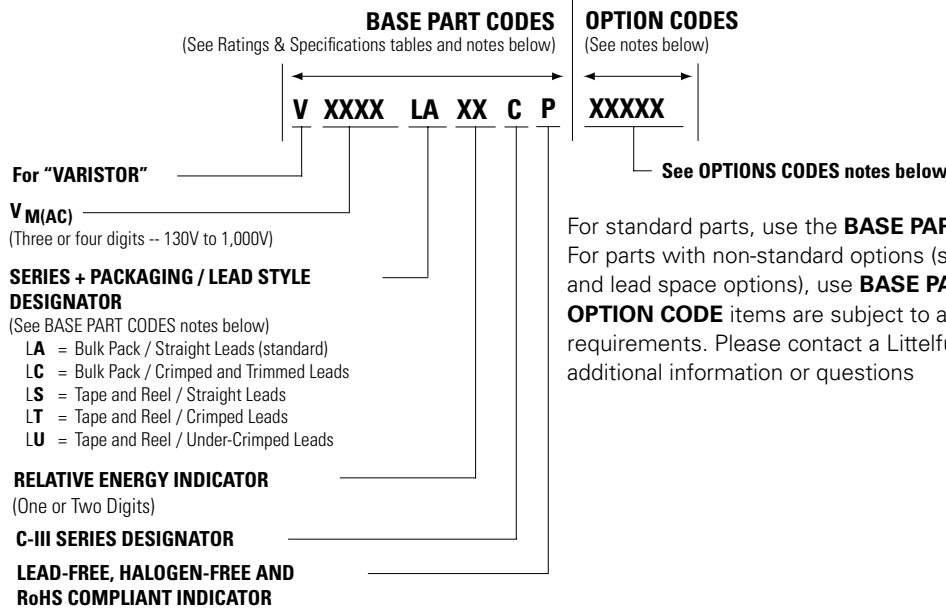


Symbol	Description	Model Size		
		10mm	14mm	20mm
P	Pitch of Component	25.4 -/+ 1.0		
P <sub>0</sub>	Feed Hole Pitch	12.7 -/+ 0.2		
P <sub>1</sub>	Feed Hole Center to Pitch	8.85 -/+ 0.8		
P <sub>2</sub>	Hole Center to Component Center	12.7 -/+ 0.7		
F	Lead to Lead Distance	7.50 -/+ 0.8		
h	Component Alignment	2.00 Max		
W	Tape Width	18.25 -/+ 0.75		
W <sub>0</sub>	Hold Down Tape Width	12.0 -/+ 0.3		
W <sub>1</sub>	Hole Position	9.125 -/+ 0.625		
W <sub>2</sub>	Hold Down Tape Position	0.5 Max		
H	Height From Tape Center To Component Base	19.0 -/+ 1.0		
H <sub>0</sub>	Seating Plane Height	16.0 -/+ 0.5		
H <sub>1</sub>	Component Height	36 Max	40 Max	46.5 Max
D <sub>0</sub>	Feed Hole Diameter	4.0 -/+ 0.2		
t	Total Tape Thickness	0.7 -/+ 0.2		
p	Component Alignment	3° Max		
U	Under crimp Width	8.0 Max		

# C-III Series

## Radial Leaded Varistors

### Part Numbering System



### Ordering Notes:

#### BASE PART CODES:

#### Series + Packaging / Lead Style Designators:

Ordering examples:

Straight Lead Bulk Pack (standard)	Straight Lead Tape & Reel	Crimped & Trimmed Lead Bulk Pack	Under-Crimp Lead Tape & Reel
V130LA20CP	V130LS20CP	V130LC20CP	V130LU20CP

Crimped leads are standard on LA Series varistors supplied in tape and reel, denoted with "LT."

"LC" style is supplied in bulk only.

"LU" style is supplied in tape & reel only.

For crimped leads without trimming and any variations other than that described above, please contact Littelfuse.

#### Packaging and Quantities:

Littelfuse C-III Series varistors are shipped standard in bulk pack with straight leads and lead spacing outlined in the Package Dimensions section of this data sheet.

Tape & Reel Quantities:

Device Size	Voltage	Quantity Per Reel		
		"T" Reel	"S" Reel	"U" Reel
10mm	ALL	500	500	500
14mm	≤ 275V	500	500	500
	≥ 275V	400	400	400
20mm	≤ 275V	500	500	500
	≥ 275V	400	400	400

#### OPTION CODES:

#### X10: 10MM LEAD SPACING OPTION --

For 10 (-/+1)mm lead spacing (available on 20mm diameter models only), append standard model BASE PART number with "X10."

Example:

Standard Model	Order As
V130LA20CP	V130LA20CPX10

#### X2855: Nickel Barrier COATED WIRE OPTION --

All standard parts use tinned copper clad steel wire. Nickel Barrier Coated wire is available as an option, consisting of Copper wire with a flashing of Nickel followed by a top coating of Tin. To order append standard model BASE PART number with "X2855."

Example:

Standard Model	Order As
V130LA20CP	V130LA20CPX2855

#### X1347: Hi-Temperature phenolic coating option --

Phenolic Coated C-III Series devices are available with improved maximum operating maximum temperature of 125°C.

To order, add X1347 to end of part number

(Example: V230LA40CPX1347).

For additional information please refer to the section labeled "Phenolic Coating Option" on the third page of this document under the "Electrical Characteristics" table.

**Disclaimer Notice** - Information furnished is believed to be accurate and reliable. However, users should independently evaluate the suitability of and test each product selected for their own applications. Littelfuse products are not designed for, and may not be used in, all applications. Read complete Disclaimer Notice at [www.littelfuse.com/disclaimer-electronics](http://www.littelfuse.com/disclaimer-electronics).