



深圳市矽源特科技有限公司

ShenZhen ChipSourceTek Technology Co. ,Ltd.

V58 OTP 系列

產品規格書

4 I/O 單通道語音晶片

V58020/ V58040/V58080



矽源特科技
ChipSourceTek

ChipSourceTek reserves the right to modify and update the product documentation without prior notice. Information provided by ChipSourceTek is believed to be accurate and reliable. However, ChipSourceTek makes no warranty for any errors which may appear in this document. Contact ChipSourceTek to obtain the latest version of device specifications before placing your orders. No responsibility is assumed by ChipSourceTek for any infringement of patent or other rights of third parties which may result from its use. In addition, ChipSourceTek products are not authorized for use as critical components in life support devices/systems or aviation devices/systems, where a malfunction or failure of the product may reasonably be expected to result in significant injury to the user, without the express written approval of ChipSourceTek.



V58產品概觀:

V58 系列為全新世代高性價比的語音晶片，具有 9bits 高性能 PWM/DAC 語音引擎。並且具備有 20~80 秒(6K/4bits)多樣化的型號選擇，簡易應用上無需添加任何外部元件，讓整體成本具有市場領先優勢。此外，本系列可一次性燒寫程序內容，提供人性化的編譯介面，無需寫程式代碼，簡化產品開發流程。

V58功能概述:

- (1.) 工作電壓 : 2.0V~5.5V
- (2.) 語音引擎 : 9bits PWM / 9bits DAC
- (3.) 語音編碼 : 4~9 bits, 共 8 階壓縮率
- (4.) 最多支持 63 個群組(Group)和 3800 個功能格(Step)
- (5.) 支持 SPI 控制模式(MCU mode)
- (6.) 支持單線控制模式(Serial mode)
- (7.) 支持低電量檢測(LVD)和低電壓復位(LVR)
- (8.) 不同的觸發型態選擇
 - ✧ Re-triggered / Irre-triggered.
 - ✧ Level / Edge
 - ✧ Hold / Un-hold.
 - ✧ Voice Repeat / One-time voice.
 - ✧ On / Off function.
 - ✧ De-bounce time : 50us or 10ms
- (9.) 可程式化輸出狀態
 - ✧ 可選擇固定頻率的閃爍方式
 - ✧ 可在語音內加入自定義的閃爍方式，包含漸明、漸暗效果(LED PWM)
 - ✧ 請參考鈺紳 Wave editor 工具
- (10.) 多樣化播放速率選擇
 - ✧ 3.0KHz / 3.2KHz / 3.8KHz / 4KHz / 4.8KHz
 - ✧ 6.0KHz / 6.4KHz / 8KHz / 9.6KHz / 12KHz
 - ✧ 16KHz / 19.2KHz / 24KHz / 32KHz
- (11.) 簡易流程編成
 - ✧ 工作暫存器寫入
 - ✧ 工作暫存器累加
 - ✧ 工作暫存器比較分支



V58母體比較表:

Body / 母體	Duration/預估秒數	IO counts / 介面數
V58080	80" @6K/4bits	4
V58040	40" @6K/4bits	4
V58020	20" @6K/4bits	3

矽源特科技
ChipSourceTek



V58封裝腳位圖:

V58080 / V58040 SOP8-1A



V58腳位說明:

Pin Name	Pin Type	Description
VDD	P	電源供應腳
VSS	P	接地腳
PWM1	Output	PWM
PWM2	Output	PWM / DAC
TG1	I/O	Tigger1 / LED PWM3 / SPI DI
TG2	I/O	Tigger2 / Pause & Resume / LED PWM2 / Reset(Low active) / SPI CLOCK
TG3	I/O	Tigger3 / Volume Control / LED PWM1 / SPI DO
TG4	I/O	Tigger4 / Volume Control / LED PWM3 / SPI CS (Optional)



V58封裝腳位圖:

V58020 SOP8-1C



V58腳位說明:

Pin Name	Pin Type	Description
VDD	P	電源供應腳
VSS	P	接地腳
PWM1	Output	PWM
PWM2	Output	PWM
TG1	I/O	TG1 / Volume Control / LED PWM3 / SPI DI
TG2	I/O	TG2 / Low active RESET / LED PWM2 / SPI CLOCK
TG3	I/O	TG3 / Volume Control / LED PWM1 / SPI DO



V58應用線路圖:

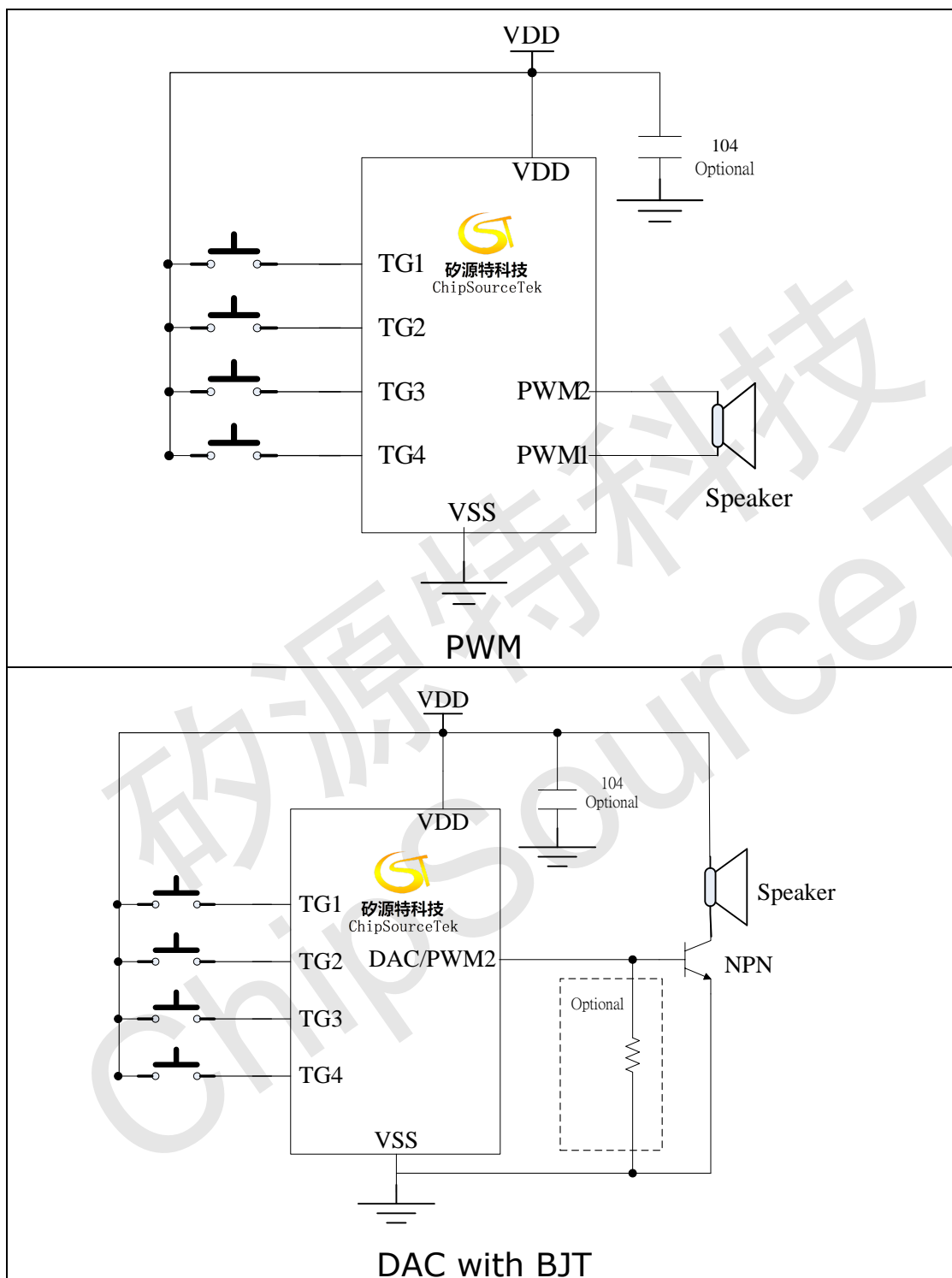



V58按鍵觸發模式:

(a) Trigger Pulse Width < Group Length

Option Setting = Edge / Unhold

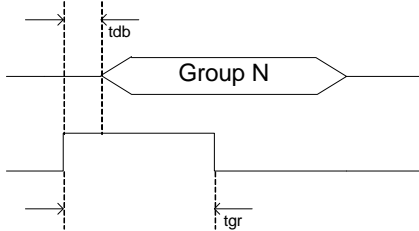

(b) Trigger Pulse Width < Group Length

Option Setting = Edge / Hold

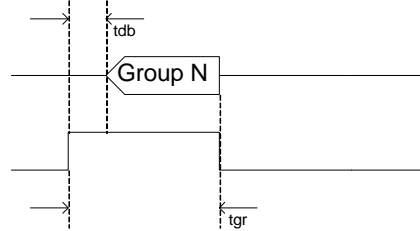

(c) Trigger Pulse Width < Group Length

Option Setting = Level / Unhold

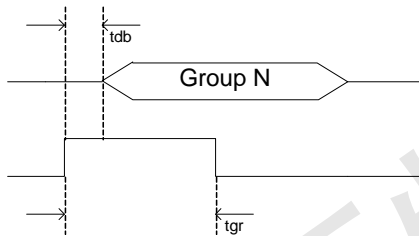

(d) Trigger Pulse Width < Group Length

Option Setting = Level / Hold

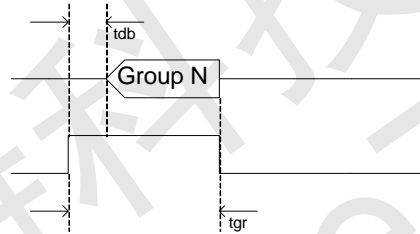

(e) Trigger Pulse Width > Group Length

Option Setting = Edge / Unhold

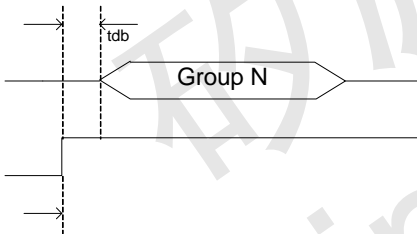

(f) Trigger Pulse Width > Group Length

Option Setting = Edge / Hold

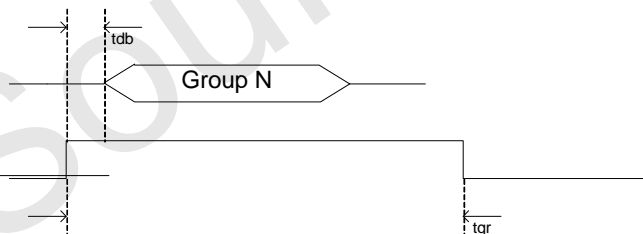

(g) Trigger Pulse Width > Group Length

Option Setting = Level / Unhold

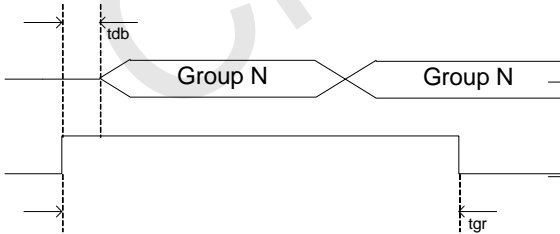

(h) Trigger Pulse Width > Group Length

Option Setting = Level / Hold

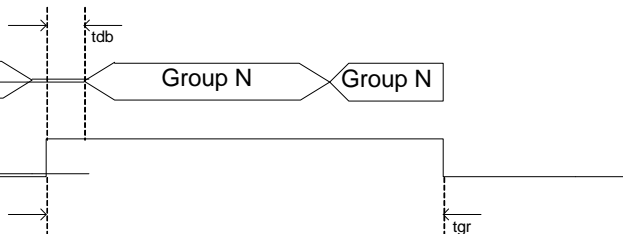



(i) Option Setting = Retrigger

(j) Option Setting = Irretrigger

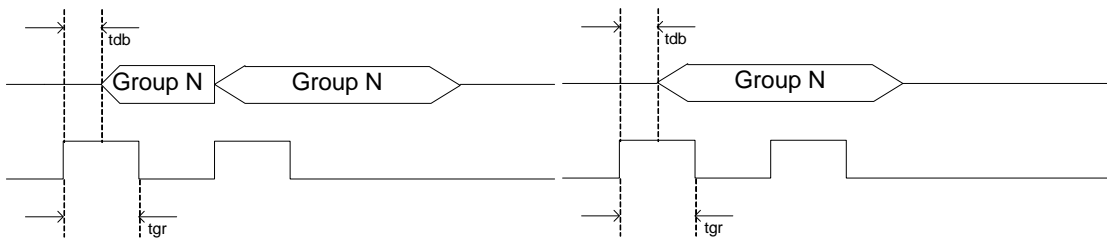

(k) TG1 = Sequential Trigger & From Group1~Group5

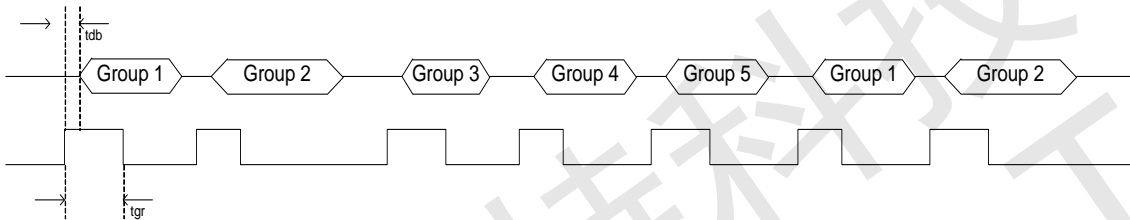

矽源特科技
ChipSourceTek



V58觸發語音組合案例:

Voice File	Description
Voice File A	Hello (1.5")
Voice File B	Good Morning (3")
Voice File C	John (1")
Voice File D	Tom (1")
Voice File E	Mary (1.5")

Group1 = Step1 + Step 2

Group 2 = Step3 + Step 4 + Step 5

Group 3 = Step 6 + Step 7

Group1 = Hello John

Group 2= Hello Tom Good Morning

Group 3 = Good Morning Mary

Step1 = Voice File A

Step 2 = Voice File C

Step 3 = Voice File A

Step 4 = Voice File D

Step 5 = Voice File B

Step 6 = Voice File B

Step 7 = Voice File E

Total use 3 Group , 7 Steps

Voice duration= Hello + Good Morning + John + Tom + Mary

= 1.5" + 3" + 1" + 1" + 1.5"

= 8"

Total duration = 8"(80"-8" = 72" space is free , can add more Voice File, If body=V58080)



V58 MCU 模式指令表:

Command	PIN	Command Data	Clock Count	Description
Initial	TG1	0x1E5858	24 clk	Wake up the chip
	TG3			
START	TG1	0x0A0140	24 clk	Wake up the chip
	TG3			
STOP	TG1	0x0A0100	24 clk	Stop the chip (Enter sleep mode)
	TG3			
PLAY	TG1	0x18+ Group Address Ex:0x00C8	24 clk	Play Voice Step Address
	TG3			
PAUSE	TG1	0x1600	16 clk	Pause the Playback and hold the Voice data
	TG3			
RESUME	TG1	0x1600	16 clk	Resume Playback from the previous Voice data
	TG3			
Check PAUSE	TG1	0x2200		Check Voice is pause or not. DO.Bit3=1:PAUSE
	TG3	Read 1 byte(Check DO[3])		
Read Busy	TG1	0x2200	16 clk	Check Voice is Stop or Not
	TG3	Read 1 byte(Check DO[6])		
Change Volume	TG1	0x0A05+ Volume(00~07) Ex: Volume = 5 , DI = 0x0A0505	24 clk	
	TG3			
Change Play Rate	TG1	0x0A06+ PR PR = 0x00~0x1D PlayRate = 96Khz/(32-PR)	24 clk	
	TG3			

◆ Group Address is generated by the Tool.



V58 MCU 模式時序圖:

TG4 – SPI CS in (Optional)

TG2 – SPI clock in (Frequency < 20 MHz , SCK)

TG1 – SPI data in (DI)

TG3 – SPI data out (DO)

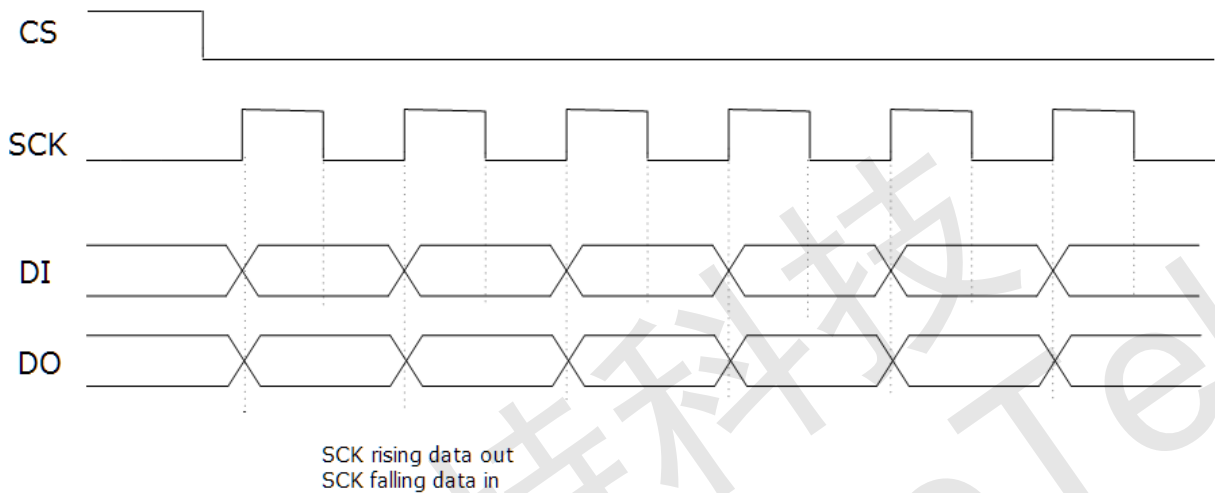

範例：讀取 ID = 0x20 , 0x00 (讀入 0x8C)

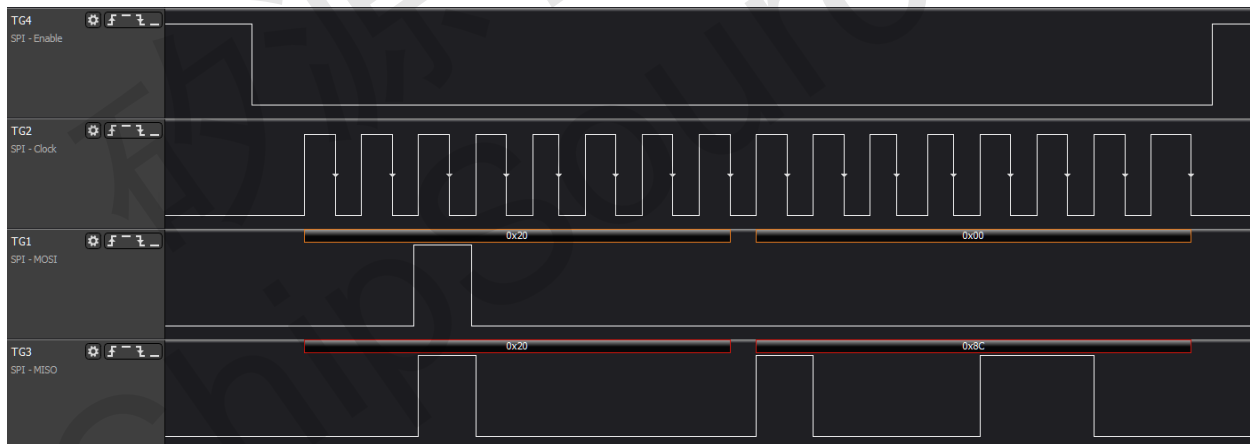



V58直流特性:

Symbol	Parameter	Min	Typ	Max	Unit	Condition
VDD	Operating Voltage	2.0		5.5	V	1.536MHz
I _{sb}	Standby current			5	uA	VDD = 3.0V
				5	uA	VDD = 4.5V
I _{OP}	Operating Current		0.6		mA	VDD = 3.0V , No Load
			0.8		mA	VDD = 4.5V , No Load
I _{IH}	Input Current		2		uA	VDD=3.0V , 1.5M Pull-low
			5		uA	VDD=3.0V , 270K Pull-low
I _{OH}	Output drive Current		7		mA	VDD=3.0V TG voltage = 2.7V
I _{OL}	Output sink Current		7		mA	VDD=3V TG voltage = 0.3V
I _{POH}	PWM output current		54		mA	VDD=3.0V , V _{OH} = 2.7V
I _{POL}				67		mA
V _{IH}	Input high level		2		V	VDD=3.0V
V _{IL}	Input low level		1		V	VDD=3.0V
ΔF/F	Frequency deviation by voltage drop	-1		1	%	$\frac{F_{max}(5.0V) - F_{min}(2.0V)}{F_{max}(5.0V)}$



V58封装资讯: (Package Information)

Size Symbols	Min (mm)	Max (mm)	Size Symbols	Min (mm)	Max (mm)
A	4.80	5.00	C3	0.05	0.20
A1	0.356	0.456	C4	0.203	0.233
A2	1.27TYP		D	1.05TYP	
A3	0.345TYP		D1	0.40	0.80
B	3.80	4.00	R1	0.20TYP	
B1	5.80	6.20	R2	0.20TYP	
B2	5.00TYP		θ 1	17° TYP4	
C	1.30	1.60	θ 2	13° TYP4	
C1	0.55	0.65	θ 3	0° ~ 8°	
C2	0.55	0.65	θ 4	4° ~ 12°	

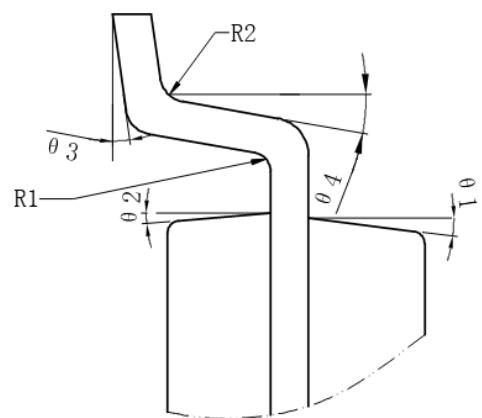
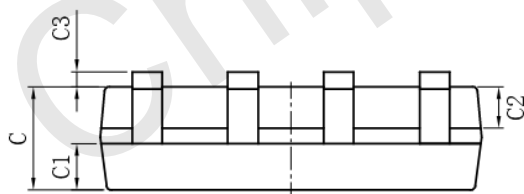
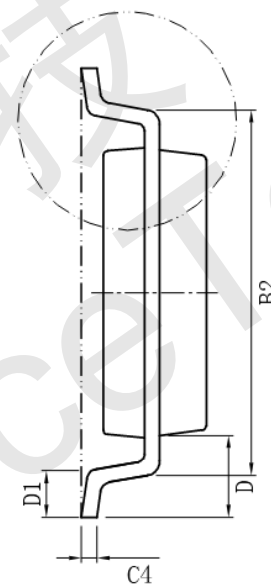
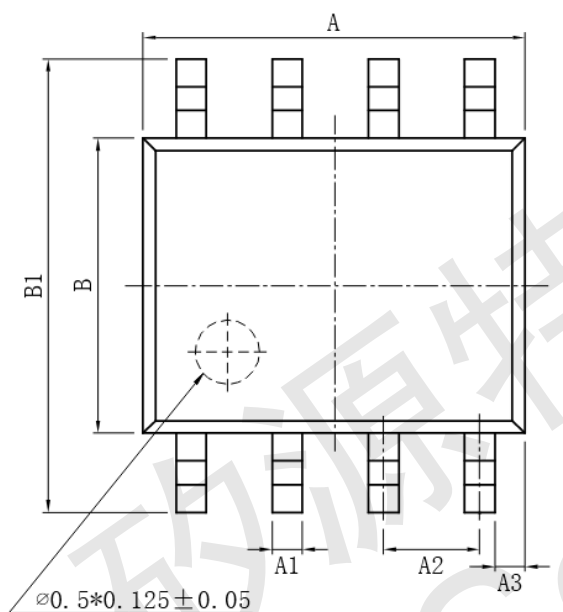



V58 Revision History

Version	Date	Page	Item	Detail
1.0.0				Initial Version

矽源特科技
ChipSourceTek