

V600 ID Systems

V600-HAR91/92/HAM91

CATALOG

OMRON

Features of Intelligent Flag/Intelligent Flag II

Upgrade Production Lines with Surprising Ease

1. Easy to Use Like a Sensor

Simply operate the Amplifier switches to select the mode and to set transmission settings. Programming is not necessary as was the case with conventional ID models.

2. No Need to be Concerned About Mechanical Troubles or Component Life

Flag codes can be overwritten through wireless transmission, which is unique to the ID System. No need to be concerned about mechanical troubles or component life because there are no mechanical parts like cylinders which are provided for older mechanical flags.

3. Precise Installation Not Required

With the long transmission distance of 65 mm max., accurate positioning as required for older sensors is not necessary. Furthermore, there is no need to be concerned about mutual interference during installation.

4. Minimal Investment for High-level Line Construction

Previously, it was necessary to make as many mechanical flags as the number of models (for example: 256 flags for 256 models). With the Intelligent Flags, however, one Data Carrier can distinguish 256 types.

Type	Flags	Sensors
Mechanical Flags	256 pieces	8 pieces
Intelligent Flags	1 piece	1 piece

5. Saves Space

A single R/W Head of the Intelligent Flag is equivalent to eight sensors and that of the Intelligent Flag II is equivalent to sixteen sensors. Accordingly, the space required for flags is largely reduced due to the use of a single Data Carrier.

6. Wide Variation

The optimum Data Carrier can be selected out of the V600-series Data Carriers depending on the application. Besides which, the Intelligent Flag can be connected to an existing line where V600-series Data Carriers can be used.

7. Provided with a Verification Function

The Intelligent Flag is provided with a verification function that is designed to collate the data read from the Data Carrier with the preset data. With this function, the Intelligent Flag can be easily used for various applications such as automatic line switching or an ID room access control system.

8. Communications Control with Only an Input Unit, Such as One From a Programmable Controller

The Intelligent Flag II saves wiring effort and makes it possible with a 16-point Input Unit, such as one from a Programmable Controller, to perform the communications control of the Intelligent Flag II.

9. Highly Reliable Data Communications

Highly reliable data communications are ensured with the parity-check output of the Intelligent Flag II, which includes parity-check results of 16-bit data to easily check for the disconnection and incorrect connection of the communications line and noise interference during communications.

Technical Guide

Intelligent Flag II Has More Advanced Functions

■ Output Used Like Sensor Output

The conventional Intelligent Flag reads data from the Data Carrier and outputs the data for a time that can be set to 10 ms, 50 ms, or continuous, the period of which may be less than the period the Data Carrier is within the transmission area. The Intelligent Flag II reads data from the Data Carrier and outputs the data for the whole period the Data Carrier is within the transmission area plus the output OFF-delay time that can be set to 10 ms, 50 ms, or 500 ms.

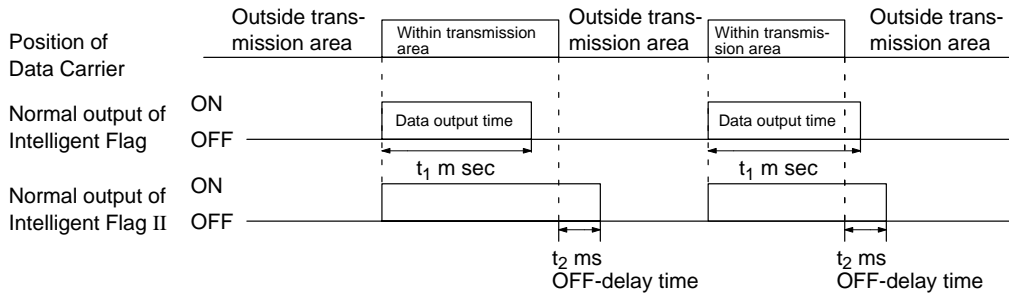

■ Wiring Saving Mode

The Intelligent Flag II has 19 output lines, which are an error output line, strobe output line, parity-check output line, and 16 data output lines, and also has two output modes. The Intelligent Flag II in mode 2 saves wiring man-hours and makes it possible for a single Input Unit, such as one from a Programmable Controller, to perform the 16-bit communications control of the Intelligent Flag II unless all 16 bits are set to 0 or 1.

■ Parity-check Output

The parity-check output line of the Intelligent Flag II makes it possible to easily check for the disconnection and incorrect connection of the line between the Intelligent Flag II and Input Unit and noise interference during communications.

The parity-check output of the Intelligent Flag II will be OFF if the number of its data output lines turned ON is even and ON if the number of its data output lines turned ON is odd.

The construction of an advanced line and system is possible with the Intelligent Flag or Intelligent Flag II at a minimal cost. The following are typical application examples, each in which the Intelligent Flag or Intelligent Flag II is used.

8-bit Intelligent Flag Ideal for a Wide Variety of Applications

Product Distinction

The system is designed to distinguish different products by reading their codes. With the V600-HAR91, the read data is output in parallel for easy distinction. The V600-HAM91 allows the data to be overwritten freely and can easily cope with changes in product types. When used in combination with the Programmable Controller and a display, the system facilitates on-site line distribution or status confirmation.

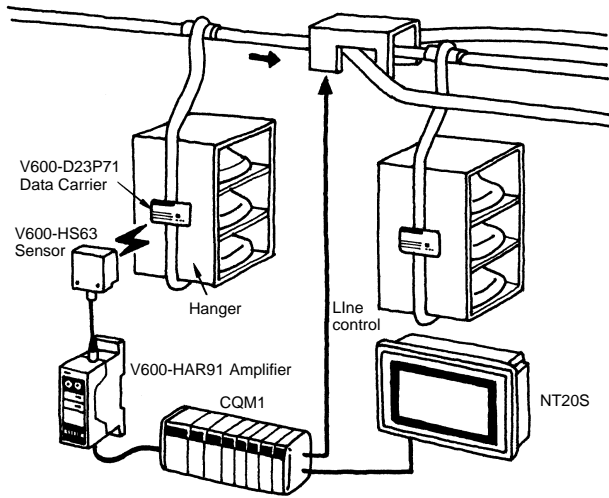

Room Access Control

It is costly and takes up much space to provide a personal computer control system that unlocks the door only for those with a special registered code. Room access control can be realized more easily and at a lower cost by forming a system in which the V600-HAM91 is connected to a compact Programmable Controller or sensor controller. The verification function, if used in the system, will allow easy distinction between the preset code registered on the door side and the code registered on the Data Carrier carried by the DC holders, resulting in a more simplified system configuration.

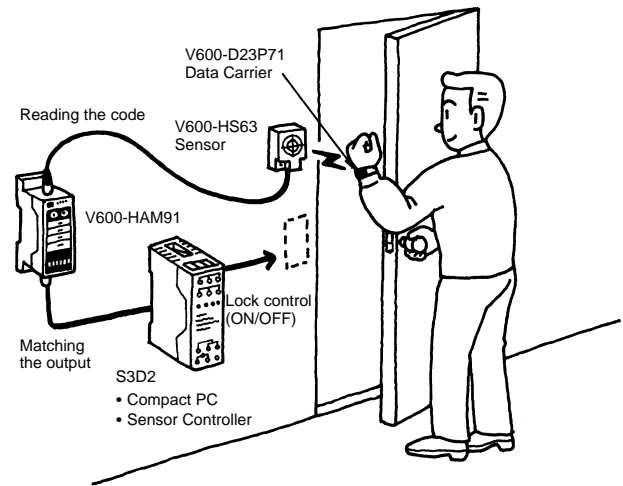

Production Process Control

The system is designed to read product codes and Process Completion Flags from the Data Carrier in order to check each process and perform the designated tasks. When the tasks in the process are completed, the Process Completion Flag is turned ON (writing "1"). The V600-HAM91 allows overwriting of each bit with an independent meaning assigned to each one of the 8 bits.

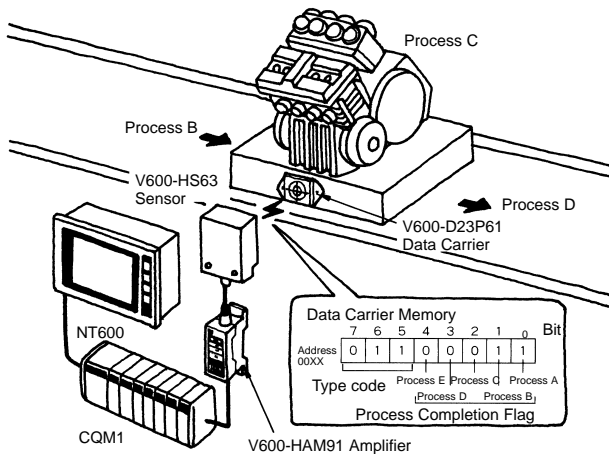

16-bit Intelligent Flag

Product Distinction with Electronic Kanban

The V600-HAR92 reads each product code to display it in alphanumeric characters within four characters on the Display Unit as an electronic Kanban, thus reducing the number of paper sheets used for production process control and careless mistakes.

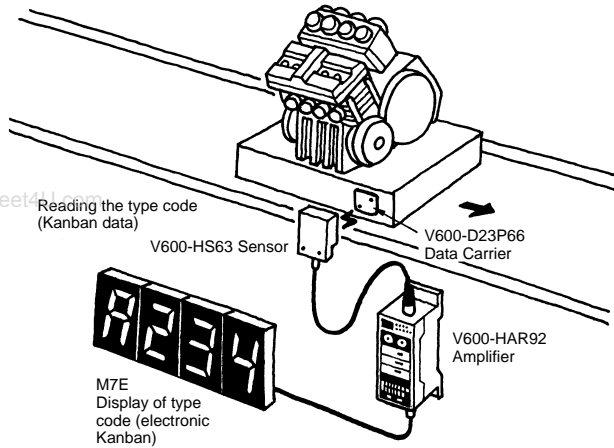

Product Quality Control for Conforming to ISO and GMP Requirements and in Consideration of Product Liability

The V600-HAR92 handles the product codes, product inspection data, and production process data of a variety of products, thus making it possible to manufacture the products efficiently while referring to the product inspection data and ensuring improvements in product quality control.

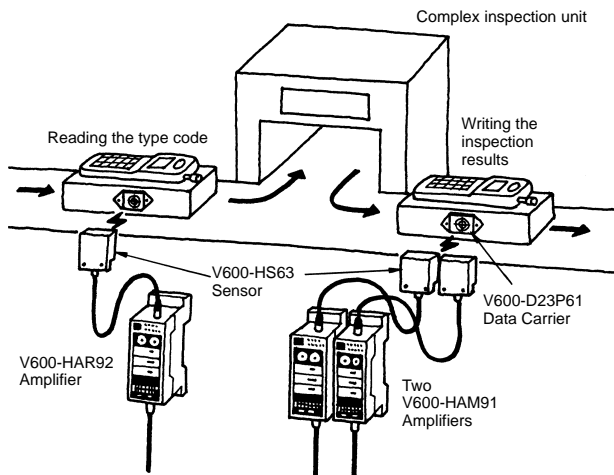

Distinction of Different Products

The V600-HAR92 in mode 2 saves wiring effort and makes it possible for a 16-point Input Unit to perform the 16-input communications control of the V600-HAR92 via a Unit saving wiring, and is ideal for the distinction of the different products on a belt conveyor line.

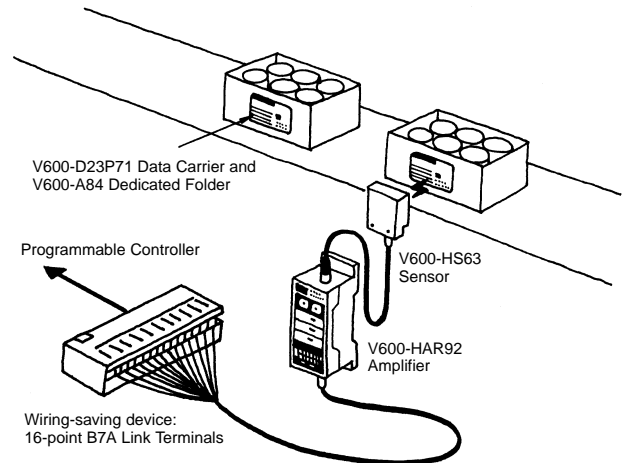

16-bit Intelligent Flag II and 8-bit Intelligent Flag are Ideal for a Greater Variety of Applications

Products and Main Functions

■ Products

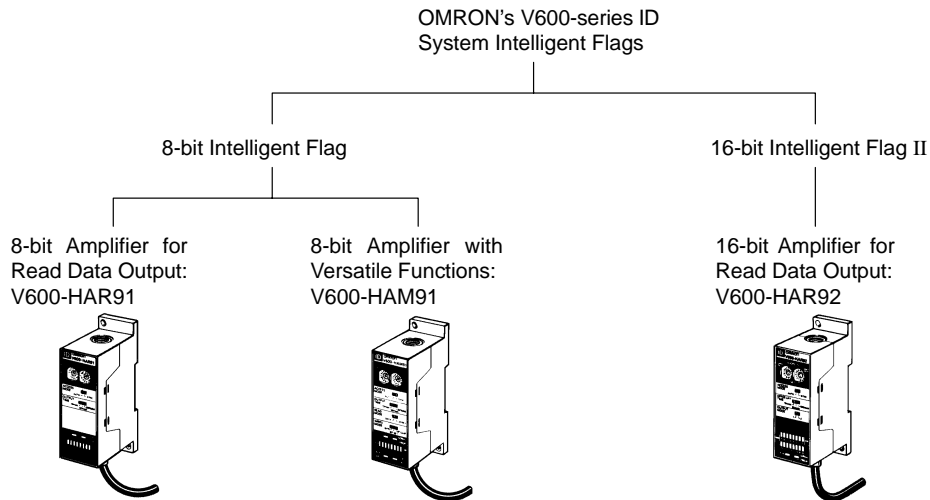

■ Main Functions

Functions		V600-HAR91	V600-HAM91	V600-HAR92
Data reading	8 bits	Yes	Yes	(Yes)
	16 bits			Yes
Data writing	8 bits (1 byte), block		Yes	
	1 bit (ON or OFF), independent		Yes	
Verification of read data with set data			Yes	
Parity-check code output				Yes
Wiring saving mode				Yes

Ideal Combinations

The construction of an advanced line and system is possible with the Intelligent Flag or Intelligent Flag II at a minimal cost. The following lists the Intelligent Flag or Intelligent Flag II that will operate the most efficiently for a given application.

List of Application Examples

Application	Data		Process	Model				Page
				V600-HAR91	V600-HAM91	V600-HAR92	General-purpose ID system	
Product distinction	256 types/8 bits max.		Writing of product data		Yes		(Yes)*	8
			Reading of product data	Yes				
	257 types/9 bits min.		Writing of product data		(Yes) Two Units		Yes	
			Reading of product data			Yes		
Kanban	Alphanumeric characters 3 to 4 digits (12 to 16 bits)		Writing of Kanban data				Yes	9
			Reading of Kanban data			Yes		
Product distinction and production process control	A total of 8 bits max. Example: Distinction of 16 types of products/4 bits max. Production process control of 4 processes/4 bits max.		Writing of product data and resetting of production process control data		Yes		(Yes)*	11
			Reading of product data	Yes	(Yes)			
			Writing of production Process Completion Flag		Yes			
			Reading of all data (product data and production process control data)	Yes				
A total of 16 bits max.	Example: Distinction of 256 types of products/8 bits max. Production process control of 8 processes/8 bits max.	Writing of product data write and resetting of production process control data		Yes		(Yes)*	12	
		Reading of product data	Yes					
		Writing of production Process Completion Flag		Yes				
		Reading of all data (product data and production process control data)			Yes			
A total of 16 bits max.	Example: Distinction of 128 types of products/7 bits max. Production process control of 9 processes/9 bits max.	Writing of product data and resetting of production process control data		Yes		(Yes)*	13	
		Reading of product data	Yes					
		Writing of production Process Completion Flag		Yes				
		Reading of all data (product data and production process control data)			Yes			

Application	Data		Process	Model				Page
				V600-HAR91	V600-HAM91	V600-HAR92	General-purpose ID system	
Product distinction and production quality control	A total of 8 bits max. Example: Distinction of 8 types of products/3 bits max. Product quality control of 5 processes/5 bits max.		Writing of product data and resetting of product quality control data		Yes		(Yes)*	14
			Reading of product data	Yes				
			Writing of product quality control data (Accepted or Rejected)		Yes			
			Reading of all data (product data and product quality control data)			Yes		
A total of 16 bits max.	Example: Distinction of 256 types of products/8 bits max. Production process control of 8 processes/8 bits max.	Writing of product data and resetting of product quality control data		Yes		(Yes)*	15	
		Reading of product data	Yes					
		Writing of product quality control data (Accepted or Rejected)		Yes				
		Reading of all data (product data and product quality control data)			Yes			
A total of 16 bits max.	Example: Distinction of 128 types of products/7 bits max. Production process control of 9 processes/9 bits max.	Writing of product data and resetting product quality control data		Yes		(Yes)*	16	
		Reading of product data	Yes					
		Writing of product quality control data (Accepted or Rejected)		Yes				
		Reading of all data (product data and product quality control data)			Yes			

Note: *When other data is written simultaneously.

Applications of Intelligent Flag or Intelligent Flag II According to the Process

Product Distinction

**Processes bit data.
Used as a mechanical flag.**

■ **Number of Product Types to Distinguish: 256 or Less**

Example: 256 Types

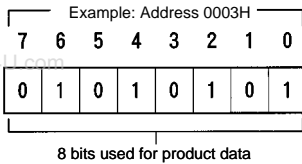

Example: 16 Types

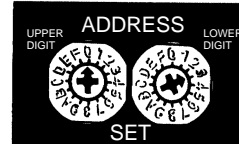
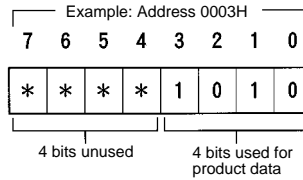

1. To write product data:
Use the V600-HAM91 and set the address to 0003H.
2. To read product data from each process:
Use the V600-HAR91. If the address is set to 0003H, 8 bits will be read.

■ **Number of Product Types to Distinguish: 257 or More (64,000 max.)**

Example: 1,024 Types

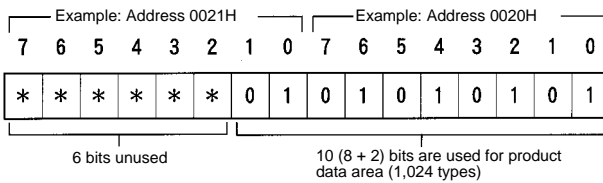

First Unit

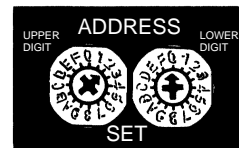

16th Unit

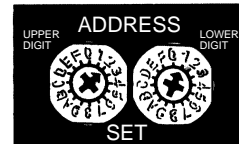

1. To write product data:
Use the conventional ID System or two V600-HAM91 Units. The address of each Unit must be unique (e.g., set the address of a Unit to 0020H and the address of the other Unit to 0021H).
2. To read product data from each process:
Use the V600-HAR92. If the address is set to 0020H, the 16 bits of 0020H and 0021H will be read.

Product Distinction

Processes Kanban data in alphanumeric characters.
With a maximum of 4 digits (16 bits).

- To write Kanban data: Use the conventional ID System.
Example: 000 to 999
0000 to FFFF

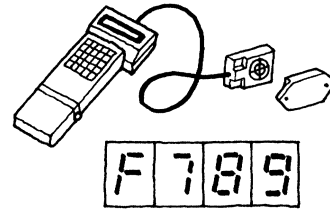
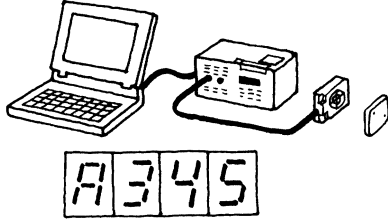

www.DataSheet4U.com

- To read Kanban data: Use the V600-HAR92 and set the address to 0010H.

To read and convert bit data to alphanumeric characters for display.

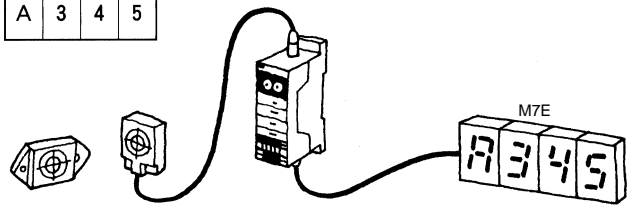
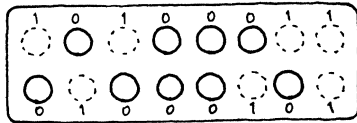
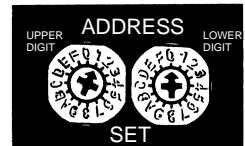
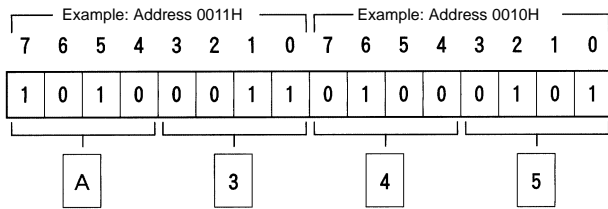

■ Utilization of Conventional ID System

The conventional ID System can be used with the Intelligent Flag II. The use of the ID System varies with the proximity system or application.

- Host: Personal computer or Serial Interface Unit with RS-232C or RS-422
Example: Serial Host Interface ID Controller
- No host
Example: IDSC-C1D□-A ID Controller

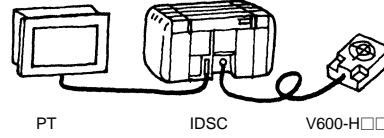
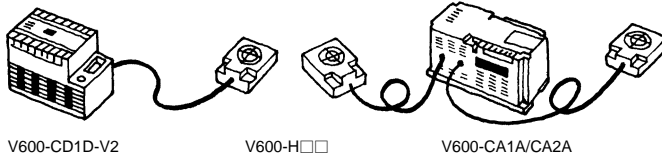

- Host: Programmable Controller
Example: Dedicated ID Sensor Unit

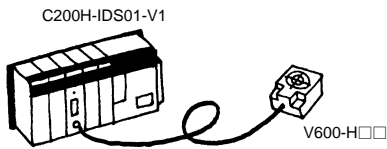

- On-site Operation with No Host
Example: Hand-held ID Controller

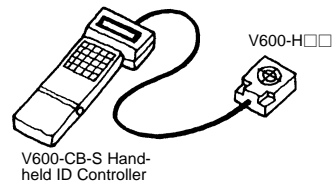

- Example: Parallel Host Interface ID Controller

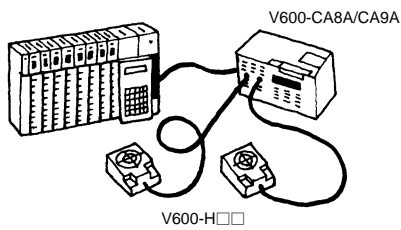

Production Process Control

Production process control with bit data and product inspection data.
 Used as a mechanical flag to distinguish products and will set a bit to 1 when a process is completed without error.

Application 1

■ No. of Product Types + No. of Processes: 8 Bits or Less

Example: 16 Product Types and 4 Processes

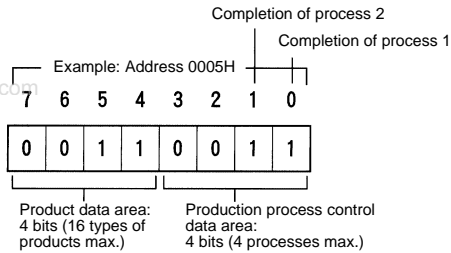

Example: 4 Product Types and 6 Processes

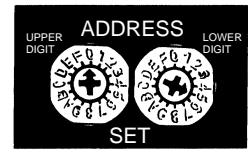
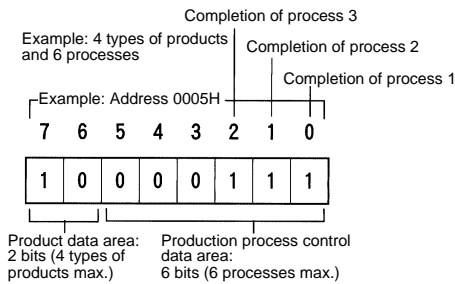

1. To write product data and reset product quality control data (set to 0):
 Use V600-HAM91 Units and set the address of each Unit to 0005H.
2. To read product data from each process:
 Use V600-HAR91 Units and set the address of each Unit to 0005H.
3. To read a Process Completion Flag from each completed process:
 Use V600-HAR91 Units and set the address each Unit to 0005H.
 A single V600-HAR91 can be used to read product data from each process and a Process Completion Flag from each completed process if they are executed at the same station.
4. To write a Process Completion Flag to each completed process. (A single bit is written by the V600-HAM91 for each process in bit set mode.):
 Use V600-HAM91 Units and set the address of each Unit to 0005H.
 A single V600-HAM91 can be used to read a Process Completion Flag from each completed process and write a Process Completion Flag to each completed process if they are executed at the same station.
5. To read all data (product data and product quality control data) at the final process:
 Use the V600-HAR91 and set the address to 0005H.

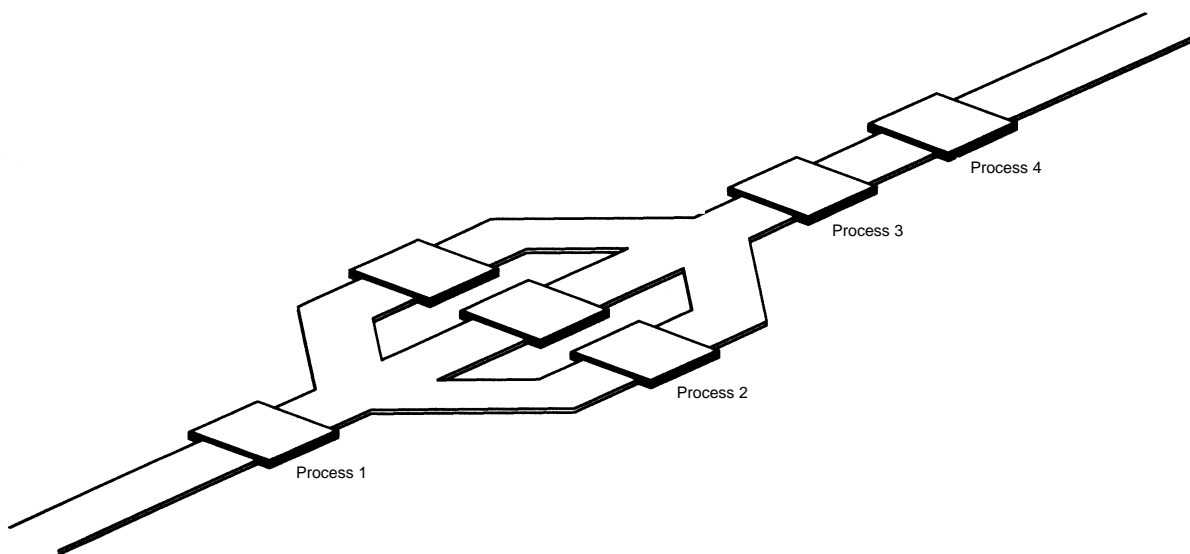

Application 2

- **No. of Product Types + No. of Processes: Between 8 and 16 Bits**
No. of Product Types: 8 Bits (256 Types) or Less and
No. of Processes: 8 Bits (8 Processes) or Less

Example: 256 Product Types and 8 Processes

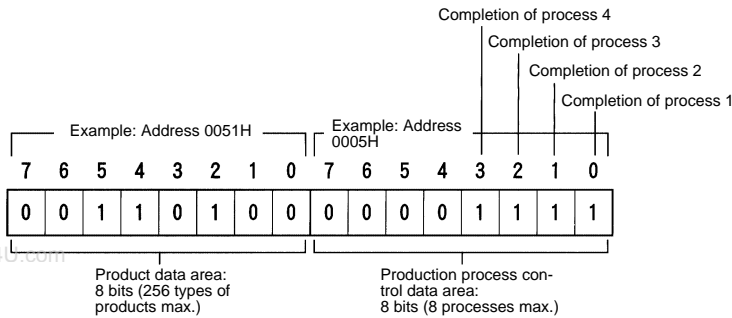

First Unit

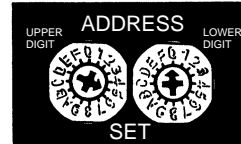

Second Unit

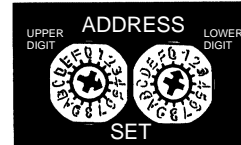

1. To write product data and reset production process control data (set to 0):
Use the conventional ID System or two V600-HAM91 Units. The address of each Unit must be unique (e.g., set the address of a Unit to 0050H and the address of the other Unit to 0051H).
2. To read product data from each process:
Use V600-HAR91 Units and set the address of each Unit to 0051H.
3. To read a Process Completion Flag from each completed process:
Use V600-HAR91 Units and set the address each Unit to 0050H.
A single V600-HAR92 can be used to read product data from each process and a Process Completion Flag from each completed process if they are executed at the same station, in which case 0050H will be used.
4. To write a Process Completion Flag to each completed process. (A single bit is written by the V600-HAM91 for each process in bit set mode.):
Use V600-HAM91 Units and set the address of each Unit to 0050H.
A single V600-HAM91 can be used to read a Process Completion Flag from each completed process and write a Process Completion Flag to each completed process if they are executed at the same station, in which case set the address to 0050H.
5. To read all data (product data and product quality control data) at the final process:
A total of 16 bits is read simultaneously.

Application 3

- **No. of Product Types + No. of Processes: 16 Bits or Less**
No. of Product Types: 7 Bits (128 Types) or Less and
No. of Processes: 9 Bits (9 Processes) or More

Example: 8 Product Types and 13 Processes

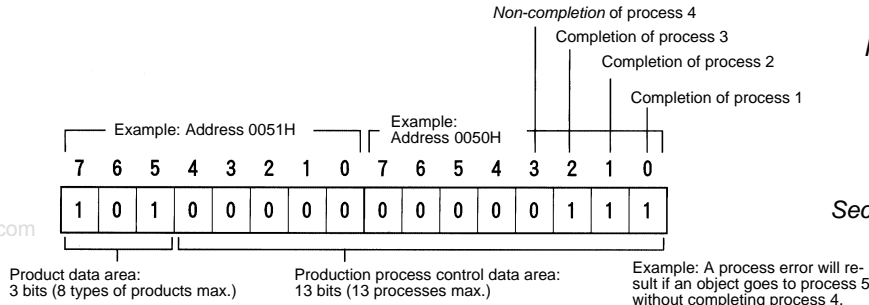

First Unit

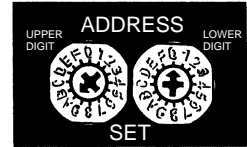

Second Unit

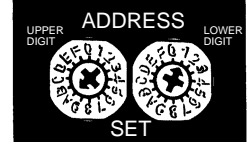

1. To write product data and reset production process control data (set to 0):
 Use the conventional ID System or two V600-HAM91 Units. The address of each Unit must be unique (e.g., set the address of a Unit to 00A0H and the address of the other Unit to 00A1H).
2. To read product data from each process:
 Use V600-HAR91 Units and set the address of each Unit to 00A1H.
3. To read a Process Completion Flag from each completed process:
 Use V600-HAR91 Units and set the address of each Unit for processes 1 to 8 to 00A0H and the address of each Unit for processes 9 to 13 to 00A1H.
 A single V600-HAR92 can be used to read product data from each process and a Process Completion Flag from each completed process if they are executed at the same station, in which case 00A0H will be used.
4. To write a Process Completion Flag each for all completed process. (A single bit is written by the V600-HAM91 for each process in bit set mode.):
 Use V600-HAM91 Units and set the address of each Unit for processes 1 to 8 to 00A0H and the address of each Unit for processes 9 to 13 to 00A1H.
5. To read all data (product data and product quality control data) at the final process:
 A total of 16 bits is read simultaneously.
 Use V600-HAR92 Units and set the address of each Unit to 00A0H.

Note: If Process Completion Flags are written to more than nine processes, set the address of each Unit for the first eight processes to 0010H and the address of each Unit for the succeeding processes to 0011H, for example.

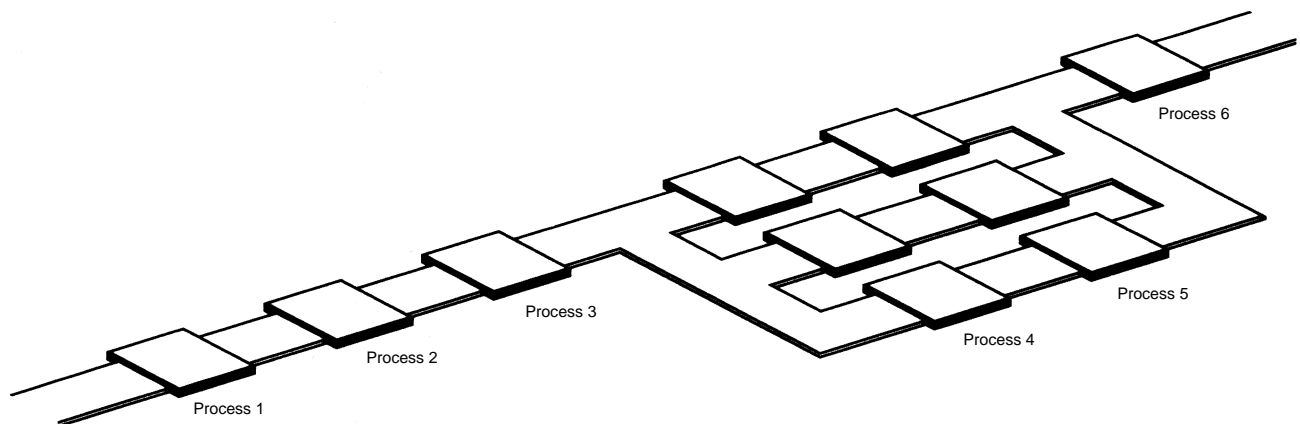

Product Quality Control

Product quality control with bit data and product inspection data.
Used as a mechanical flag to distinguish products and will set an Accepted or Rejected Flag when a product inspection is completed.

Application 1

■ **No. of Product Types + No. of Processes: 8 Bits or Less**

Example: 8 Product Types and 5 Inspection Processes

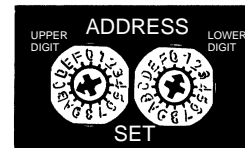
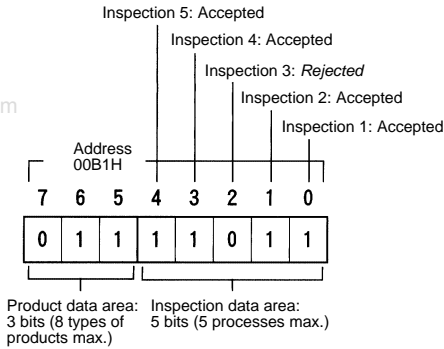

1. To write product data and reset inspection data area (set 0):
Use the V600-HAM91 and set the address to 00B1H.
2. To read product data from each inspection process. (An inspection varies with the type of product.):
Use V600-HAR91 Units and set the address of each Unit to 00B1H.
3. To read the inspection result from the previous process. (This is effective when a product must not go to the next process until the product finishes an inspection at the previous process.):
Use V600-HAR91 Units and set the address of each Unit to 00B1H.
A single V600-HAR91 can be used to read product data from each inspection process and the result of inspection from the previous process if they are executed at the same station.
4. To write the inspection result at each stage (1 for Accepted and 0 for Rejected) (A single bit is written by the V600-HAM91 for each process in bit set mode.):
Use V600-HAM91 Units and set the address of each Unit to 00B1H.
A single V600-HAM91 can be used to read product data from each inspection process, read the result of inspection from the previous process, and write the result of inspection at each process if they are executed at the same station.
5. To read all data (product data and product inspection data) at the final process:
Use the V600-HAR91 and set the address to 00B1H.

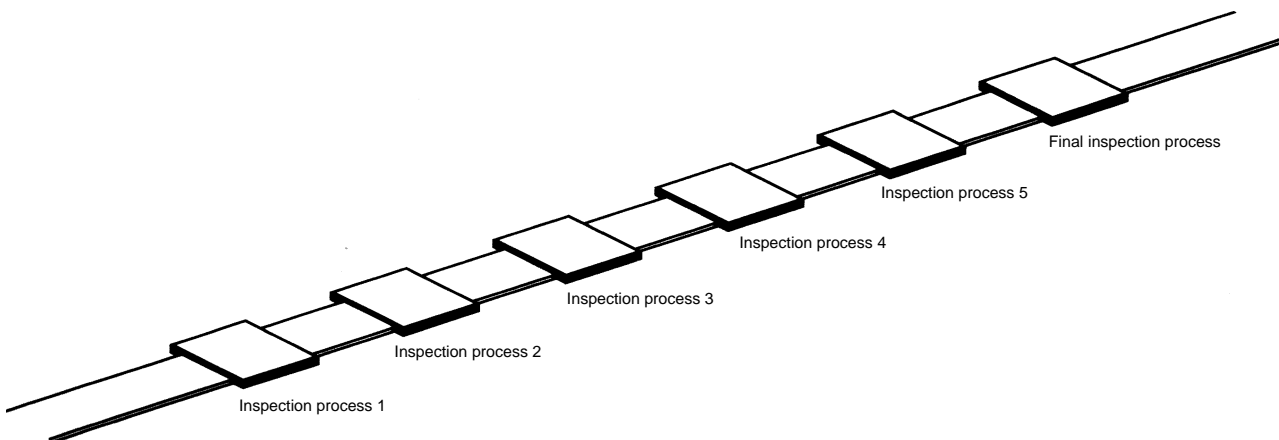

Application 2

- **No. of Product Types + No. of Processes: 16 Bits or Less**
No. of Product Types: 8 Bits (256 Types) or Less and
No. of Processes: 8 Bits (8 Processes) or Less

Example: 256 Product Types and 8 Processes

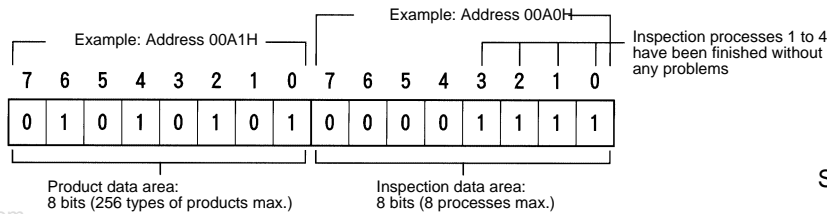

First Unit

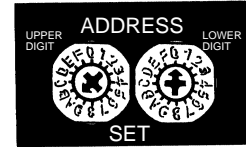

Second Unit

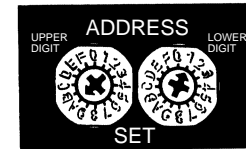

- To write product data and reset inspection data area (set 0):
Use the conventional ID System or two V600-HAM91 Units. The address of each Unit must be unique (e.g., set the address of a Unit to 00A0H and the address of the other Unit to 00A1H).
- To read product data from each inspection process. (An inspection varies with the type of product.):
Use V600-HAR91 Units and set the address of each Unit to 00A1H.
- To read the inspection result from the previous process. (This is effective when a product must not go to the next process until the product finishes an inspection at the previous process.):
Use V600-HAR91 Units and set the address of each Unit to 00A1H.
A single V600-HAR92 can be used to read product data from each inspection process and the result of inspection from the previous process if they are executed at the same station, in which case set the address to 00A0H.
- To write the inspection result at each stage (1 for Accepted and 0 for Rejected) (A single bit is written by the V600-HAM91 for each process in bit set mode.):
Use V600-HAM91 Units and set the address of each Unit to 00A1H.
A single V600-HAM91 can be used to read product data from each inspection process, read the result of inspection from the previous process, and write the result of inspection at each process if they are executed at the same station.
- To read all data (product data and product inspection data) at the final process. (A total of 16 bits is read simultaneously.):
Use the V600-HAR92 and set the address to 00A0H.

Application 3

- **No. of Product Types + No. of Processes: 16 Bits or Less**
No. of Product Types: 7 Bits (128 Types) or Less and
No. of Processes: 9 Bits (9 Processes) or More

Example: 16 Product Types and 12 Processes

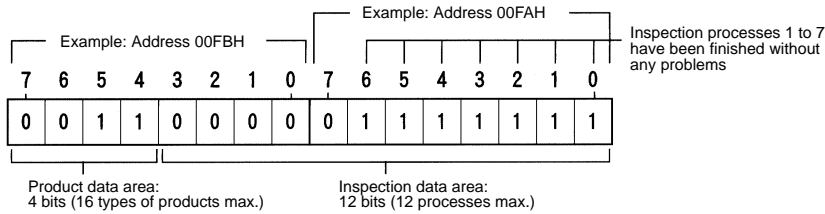

First Unit

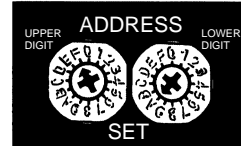

Second Unit

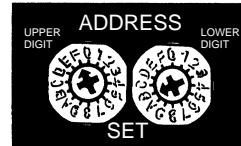

1. To write product data and reset inspection data area (set 0):
Use the conventional ID System or two V600-HAM91 Units. The address of each Unit must be unique (e.g., set the address of a Unit to 00FAH and the address of the other Unit to 00FBH).
2. To read product data from each inspection process. (An inspection varies with the type of product.):
Use V600-HAR91 Units and set the address of each Unit to 00FBH.
3. To read the inspection result from the previous process. (This is effective when a product must not go to the next process until the product finishes an inspection at the previous process.):
Use V600-HAR92 Units and set the address of each Unit for inspection processes 1 to 8 to 00FAH and the address of each Unit for processes 9 to 12 to 00FBH.
A single V600-HAR92 can be used to read product data from each inspection process and the result of inspection from the previous process if they are executed at the same station, in which case set the address to 00FAH.
4. To write the inspection result at each inspection process (1 for Accepted and 0 for Rejected) (A single bit is written by the V600-HAM91 for each process in bit set mode.):
Use V600-HAM91 Units and set the address of each Unit for inspection processes 1 to 8 to 00FAH and the address of each Unit for processes 9 to 12 to 00FBH.
5. To read all data (product data and product inspection data) at the final process. (A total of 16 bits is read simultaneously.):
Use the V600-HAR92 and set the address to 00FAH.

Note: For example, set the address of each V600-HAM91 Unit for the first eight processes to 00FAH and the address of each V600-HAM91 Unit for the succeeding processes to 00FBH if product inspection data is written to more than nine inspection processes. The V600-HAM91 in bit set mode makes it possible to easily write the result of inspection to one bit only. If the result of inspection is Rejected, the data will be 0 or cleared by the V600-HAM91 in bit clear mode.

Intelligent Flag II

V600-HAR92

A 16-bit Electronic Flag Provides an Improvement over Mechanical Flags and Kanban

- Processes 16-bit flag data and ideal for a variety of applications including 4-digit alphanumeric Kanban.
- Performs sophisticated production process control and product quality control in consideration of product liability.
- Saves wiring and remote control by a single 16-point Input Unit allows the reading and writing of flag data and other data.
- Incorporates parity-check output function for 16-bit data, thus ensuring highly reliable data communications.

Ordering Information

Amplifier	Interface Cable	Cable length
V600-HAR92 (Connector: 26 pin)	V600-A60M	2 m
	V600-A61M	5 m
	V600-A62M	10 m

- Note:**
1. The extension cable connector is not waterproof. If there is a possibility that the connector may be exposed to water, keep it inside the control box. The maximum cable length is 10 m.
 2. Refer to the V600-HAR92 Operation Manual for the V600-HAR92 Intelligent Flag II in detail.

Sensor
V600-HS51
V600-HS61
V600-HS63

Specifications



■ Characteristics

Amplifier

Item	V600-HAR92
Power supply	24 VDC ±10%, ripple (p-p): 10%
Current consumption	130 mA max.
Input	Transistor output or contact output Short-circuit current: 3 mA (typical) (IN terminal and 0-V short-circuit) OFF voltage: 15 to 30 VDC ON voltage: 0 to 5 VDC Input impedance: 8.2 kΩ Applied voltage: 30 VDC max.
Output	NPN open collector, 20 mA max. at 30 VDC, residual voltage: 2 V max.
Diagnostic functions	Checks for CPU errors and transmission errors
Insulation resistance	50 MΩ max. (at 500 VDC) between cable terminals and case
Dielectric strength	500 VAC, 50/60 Hz for 1 min between cable terminals and case
Vibration resistance	Destruction: 10 to 150 Hz, 1.5-mm double amplitude, with 4 sweeps of 8 min each in 3 directions
Shock resistance	Destruction: 294 m/s ² (approx. 30G), 3 times each in 6 directions
Ambient temperature	Operating: -10°C to 55°C (with no icing) Storage: -25°C to 65°C
Ambient humidity	Operating: 35% to 85% (with no condensation)
Enclosure rating	IP40
Ground	Ground to 100 Ω or less.
Material	ABS resin (case)
Cable length	Standard, 0.5 m with a dedicated connector (see note)
Weight	Approx. 180 g

Note: The connector is not waterproof. If there is a possibility that the connector may be exposed to water, keep it inside the control box. Be sure to use the connector together with the separately sold interface cable.

Sensor

Item	V600-HS51	V600-HS61	V600-HS63
			
Transmission frequency	530 kHz		
Ambient temperature	Operating: -10°C to 60°C Storage: -25°C to 75°C		Operating: -10°C to 70°C Storage: -25°C to 75°C
Ambient humidity	35% to 95%		
Insulation resistance	50 MΩ (at 500 VDC) between cable terminal and case		
Dielectric strength	1,000 VAC, 50/60 Hz for 1 min between cable terminal and case		
Enclosure ratings	IEC: IP67; JEM: IP67G		
Vibration resistance	Destruction: 10 to 2,000 Hz, 3-mm double amplitude, with 2 sweeps of 15 min each in 3 directions		Destruction: 10 to 500 Hz, 2-mm double amplitude, with 3 sweeps of 11 min each in 3 directions
Shock resistance	Destruction: 981 m/s ² (approx. 100G), 3 times each in 3 directions (18 times total)		Destruction: 490 m/s ² (approx. 50G), 3 times each in 3 directions (18 times total)
Cable length	2 m (fixed)		
Wireless transmission error direction	16-bit CRC (Cyclic Redundancy Check) in both directions		
Indicator	---		Power: green
Weight	Approx. 70 g		Approx. 190 g

Operation

■ Functions

Reads the 16-bit data (2 bytes) of the set address and outputs to the 16 data output lines.

■ Circuit Configuration

Input Circuit

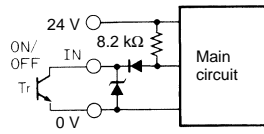

Output Circuit

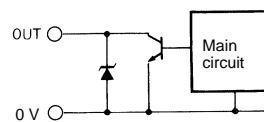

www.DataSheet4U.com

■ System Configuration

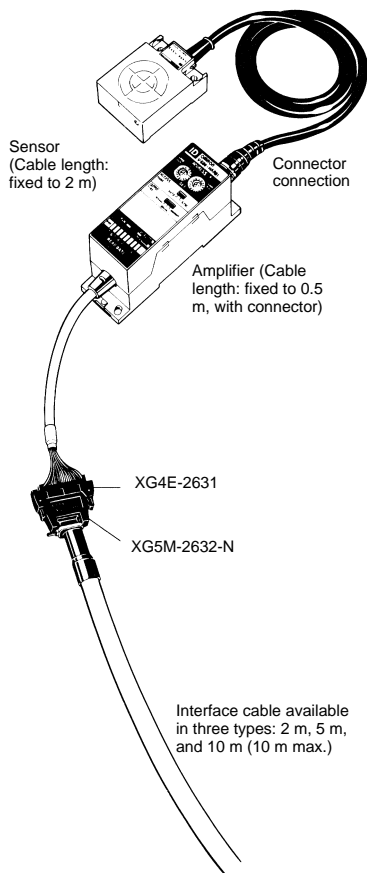

Host

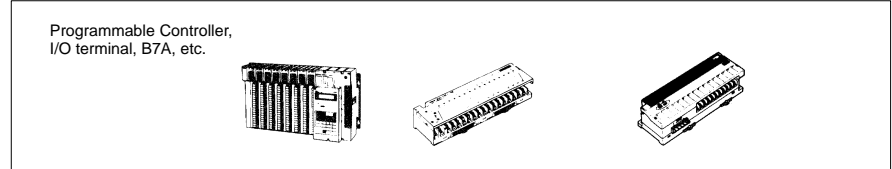

Interface cable

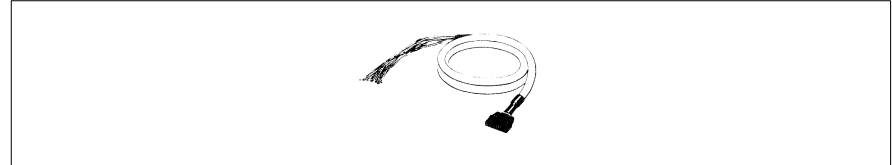

Amplifier

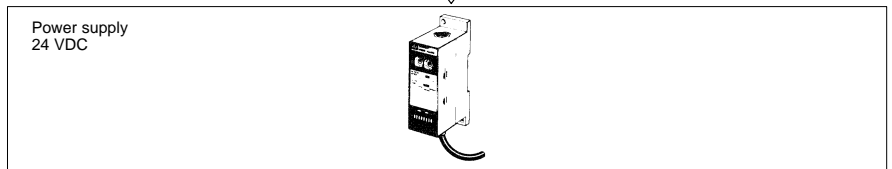

Sensor

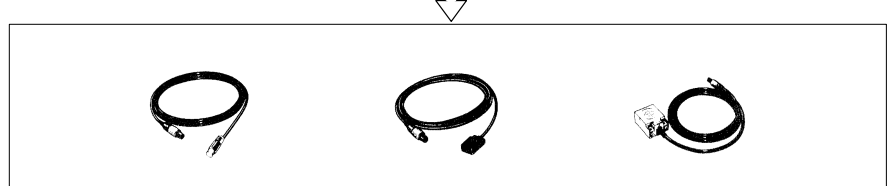

Data Carrier (DC)

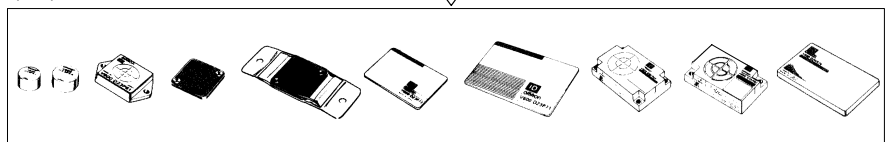

- Note:**
1. For specifications and performance of the Data Carrier, refer to the *RFID System Catalog (X067)*.
 2. For the combinations of the Sensors and Data Carriers, refer to the *Transmission Distance Specifications* on page 24.

Intelligent Flag

V600-HA

An Electronic Flag that can be Used Like a Sensor. Provides an Improvement Over Mechanical Flags by Using an ID System.

- Doesn't need a program and can be used like a sensor.
- Advanced line construction at minimal cost.
- Saves space.
- Precise installation not required (Transmission distance: 65 mm max.).
- Provided with a verification function.

Ordering Information

Amplifier	Interface Cable	Cable length
V600-HAR91 (Connector: 20 pin)	V600-A60R	2 m
	V600-A61R	5 m
	V600-A62R	10 m
V600-HAM91 (Connector: 26 pin)	V600-A60M	2 m
	V600-A61M	5 m
	V600-A62M	10 m

Note: The extension cable connector is not waterproof. If there is a possibility that the connector may be exposed to water, keep it inside the control box. The maximum cable length is 10 m.

Sensor
V600-HS51
V600-HS61
V600-HS63

Specifications



■ Characteristics

Amplifier

Item	V600-HAR91	V600-HAM91
Power supply	24 VDC \pm 10%, ripple (p-p): 10%	
Current consumption	130 mA max.	
Input	Transistor output or contact output Short-circuit current: 3 mA (typical) (IN terminal and 0-V short-circuit) OFF voltage: 15 to 30 VDC ON voltage: 0 to 5 VDC Input impedance: 8.2 k Ω Applied voltage: 30 VDC max.	
Output	NPN open collector, 20 mA max. at 30 VDC, residual voltage: 2 V max.	
Diagnostic functions	Checks for CPU errors and transmission errors	
Insulation resistance	50 M Ω max. (at 500 VDC) between cable terminals and case	
Dielectric strength	500 VAC, 50/60 Hz for 1 min between cable terminals and case	
Vibration resistance	Destruction: 10 to 150 Hz, 0.3-mm double amplitude, with 4 sweeps of 8 min each in 3 directions	
Shock resistance	Destruction: 294 m/s ² (approx. 30G), 3 times each in 6 directions	
Ambient temperature	Operating: -10°C to 55°C (with no icing) Storage: -25°C to 65°C	
Ambient humidity	Operating: 35% to 85% (with no condensation)	
Enclosure rating	IP40	
Ground	Ground to 100 Ω or less.	
Material	ABS resin (case)	
Cable length	Standard, 0.5 m with a dedicated connector (see note)	
Weight	Approx. 170 g	

Note: The connector is not waterproof. If there is a possibility that the connector may be exposed to water, keep it inside the control box. Be sure to use the connector together with the separately sold interface cable.

Sensor

Item	V600-HS51	V600-HS61	V600-HS63
			
Transmission frequency	530 kHz		
Ambient temperature	Operating: -10°C to 60°C Storage: -25°C to 75°C		Operating: -10°C to 70°C Storage: -25°C to 75°C
Ambient humidity	35% to 95%		
Insulation resistance	50 M Ω (at 500 VDC) between cable terminal and case		
Dielectric strength	1,000 VAC, 50/60 Hz for 1 min between cable terminal and case		
Enclosure ratings	IEC: IP67; JEM: IP67G		
Vibration resistance	Destruction: 10 to 2,000 Hz, 3-mm double amplitude, with 2 sweeps of 15 min each in 3 directions		Destruction: 10 to 500 Hz, 2-mm double amplitude, with 3 sweeps of 11 min each in 3 directions
Shock resistance	Destruction: 981 m/s ² (approx. 100G), 3 times each in 3 directions (18 times total)		Destruction: 490 m/s ² (approx. 50G), 3 times each in 3 directions (18 times total)
Cable length	2 m (fixed)		
Wireless transmission error direction	16-bit CRC (Cyclic Redundancy Check) in both directions		
Indicator	---		Power: green
Weight	Approx. 70 g		Approx. 190 g

■ System Configuration

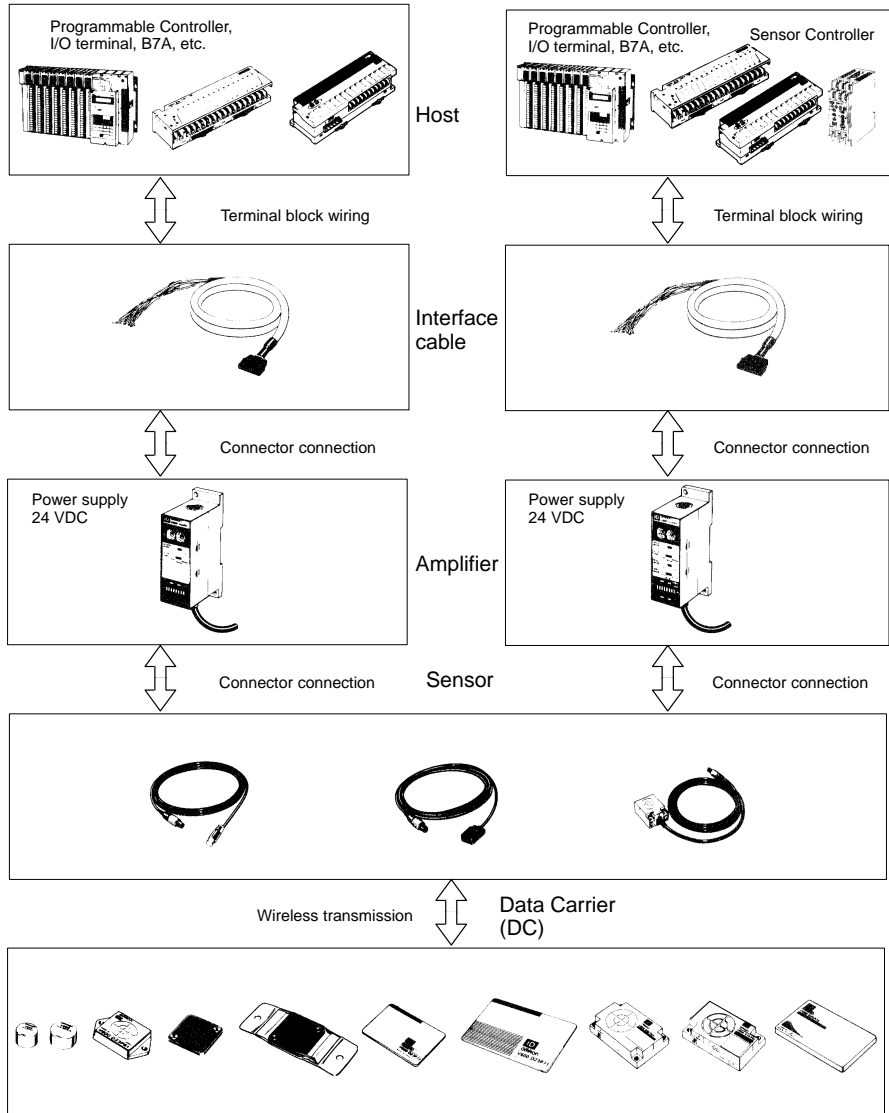
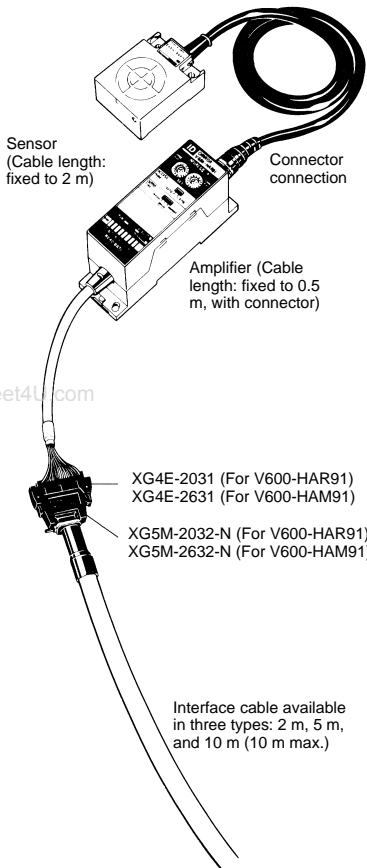

- Note:**
1. For specifications and performance of the Data Carrier, refer to the *RFID System Catalog (X067)*.
 2. For the combinations of the Sensors and Data Carriers, refer to the *Transmission Distance Specifications* on page 24.

Operation

■ Functions

V600-HAR91 (Read-only type)

Reads the 8-bit data (1 byte) of the set address and outputs to the 8 data output lines.

V600-HAM91 (Multi-functional type)

The amplifier has three basic functions.

1. Reads the 8-bit (1 byte) data of the set address and outputs to the 8 data output lines.
2. Writes on the set address the 8-bit (1 byte) data designated via the 8 data input lines.
3. Reads the 8-bit data (1 byte) of the set address, compares with the 8-bit (1 byte) data input via the 8 verification data input lines, and outputs the verification result.

■ Circuit Configuration

V600-HAR91

Input Circuit

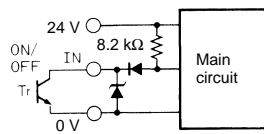

Output Circuit

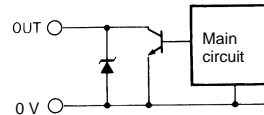

V600-HAM91

Input Circuit

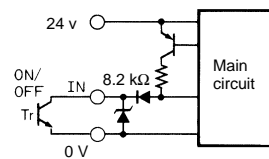

Output Circuit

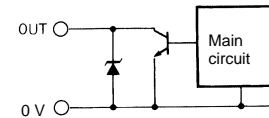

■ Transmission Distance Specifications

Recommended Combinations

Data Carrier		V600-HAR91/-HAM91		
		V600-HS51	V600-HS61	V600-HS63
Memory EEPROM	V600-D23P53	0.5 to 3.0 mm	0.5 to 3.0 mm	---
	V600-D23P54	0.5 to 5.0 mm	0.5 to 5.5 mm	---
	V600-D23P61	0.5 to 8.0 mm	0.5 to 9.0 mm	2 to 16 mm
	V600-D23P66	---	---	5 to 30 mm
	V600-D23P66SP	---	---	5 to 25 mm
	V600-D23P71	---	---	5 to 35 mm
	V600-D23P72	---	0.5 to 18 mm	5 to 35 mm
Memory SRAM	V600-D□KR12	5 to 15 mm	5 to 18 mm	5 to 45 mm
	V600-D2KR16	---	---	2 to 15 mm
	V600-D□KR04	---	---	10 to 65 mm

Note: 1. Sensor Installation Conditions

V600-HS51: When flush-mounted in iron

Axial offset from the Data Carrier: ± 2.0 mm

V600-HS61: When surface-mounted on metal (ferrous)

Axial offset from the Data Carrier: ± 2.0 mm

V600-HS63: When surface-mounted on metal (ferrous)

Axial offset from the Data Carrier: ± 10.0 mm

2. Data Carrier Installation Conditions

V600-D23P53/-P54: When flush-mounted in ferrous

V600-D23P66/-P71/-P72: When surface-mounted on resin (No metal on the backside)

V600-D23P61: When surface-mounted on metal (ferrous)

V600-D□KR12/-04: When surface-mounted on metal (ferrous)

V600-D2KR16: When the Data Carrier attached to the holder is mounted on the metal (ferrous) surface

3. The transmission distance specified in the specifications is also applicable when the Data Carrier is mounted on non-metallic surfaces.

4. The Data Carrier is stationary.

■ Transmission Range Graphs (Actual Values)

Combinations with the V600-HS51 Sensor

V600-HS51 + V600-D23P53

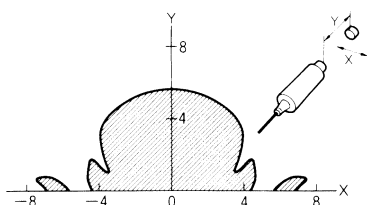

V600-HS51 + V600-D23P54

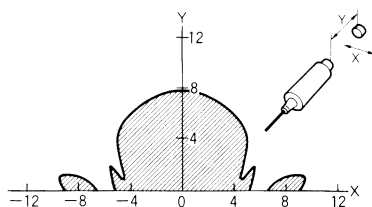

V600-HS51 + V600-D23P61

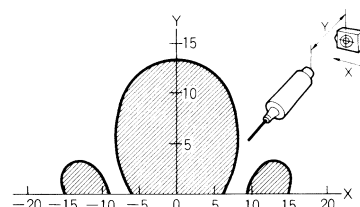

V600-HS51 + V600-D8KR12

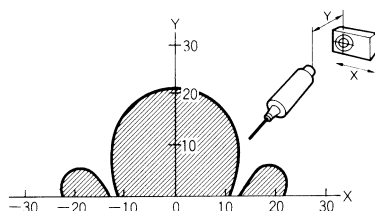

Combinations with the V600-HS61 Sensor

V600-HS61 + V600-D23P53

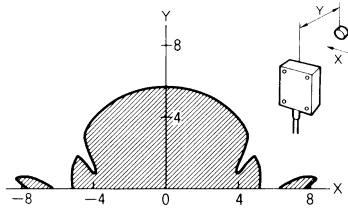

V600-HS61 + V600-D23P54

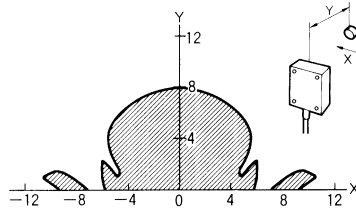

V600-HS61 + V600-D23P61

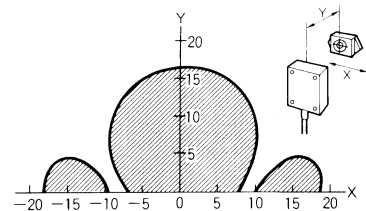

V600-HS61 + V600-D23P72

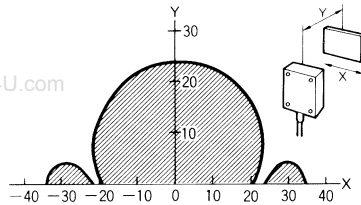

V600-HS61 + V600-D8KR12

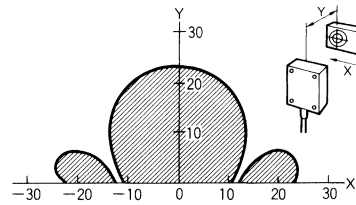

Combinations with the V600-HS63 Sensor

V600-HS63 + V600-D23P61

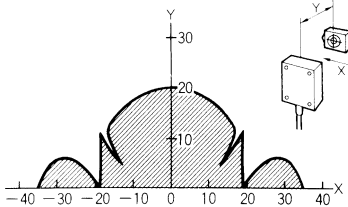

V600-HS63 + V600-D23P66

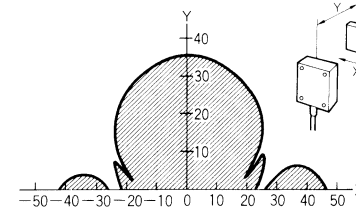

V600-HS63 + V600-D23P66SP

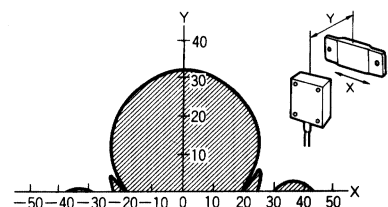

V600-HS63 + V600-D23P71

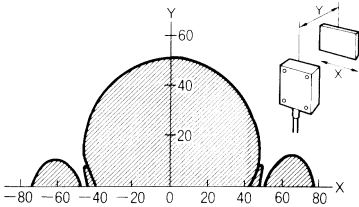

V600-HS63 + V600-D23P72

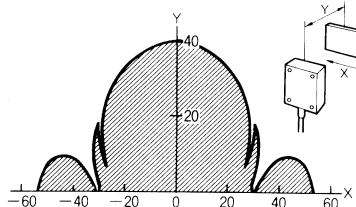

V600-HS63 + V600-D8KR12

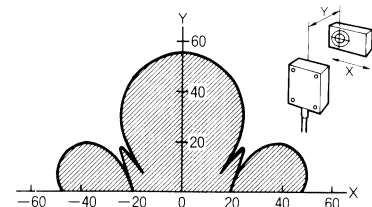

V600-HS63 + V600-D2KR16

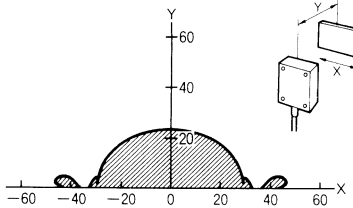

V600-HS63 + V600-D8KR04

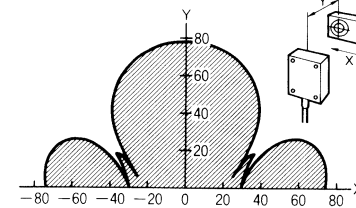

■ Transmission Time Specifications

The transmission time refers to the time required for communications between the Sensor and the Data Carrier. It is used for calculating the travel speed of the auto command.

$$\text{DC speed (conveyor speed)} = \frac{\text{Distance travelled in the transmission range}}{\text{Transmission time}}$$

R/W	V600-HAR91/HAM91			V600-HAR92
	Read	Write		Read
Mode type	DATA READ mode, VERIFY mode	BYTE mode	BIT SET mode, BIT CLEAR mode	DATA READ mode
EEPROM	75 ms	138 ms	150 ms	77 ms
SRAM	60 ms	95 ms	107 ms	62 ms

Example: Combinations with the V600-HAR91, V600-HS63, and V600-D8KR04 Sensors.

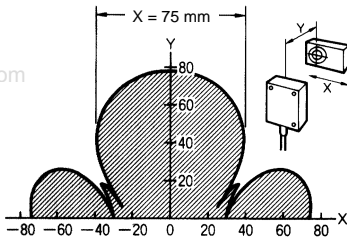

$$\text{DC speed (conveyor speed)} = \frac{75 \text{ (mm)}}{60 \text{ (ms)}} = \frac{75 \times 10^{-3} \text{ (m)}}{60 \times 10^{-3} \times 1/60 \text{ (min)}} = 75 \text{ (m/min)}$$

Dimensions

Note: All units are in millimeters unless otherwise indicated.

Amplifier

V600-HAR92

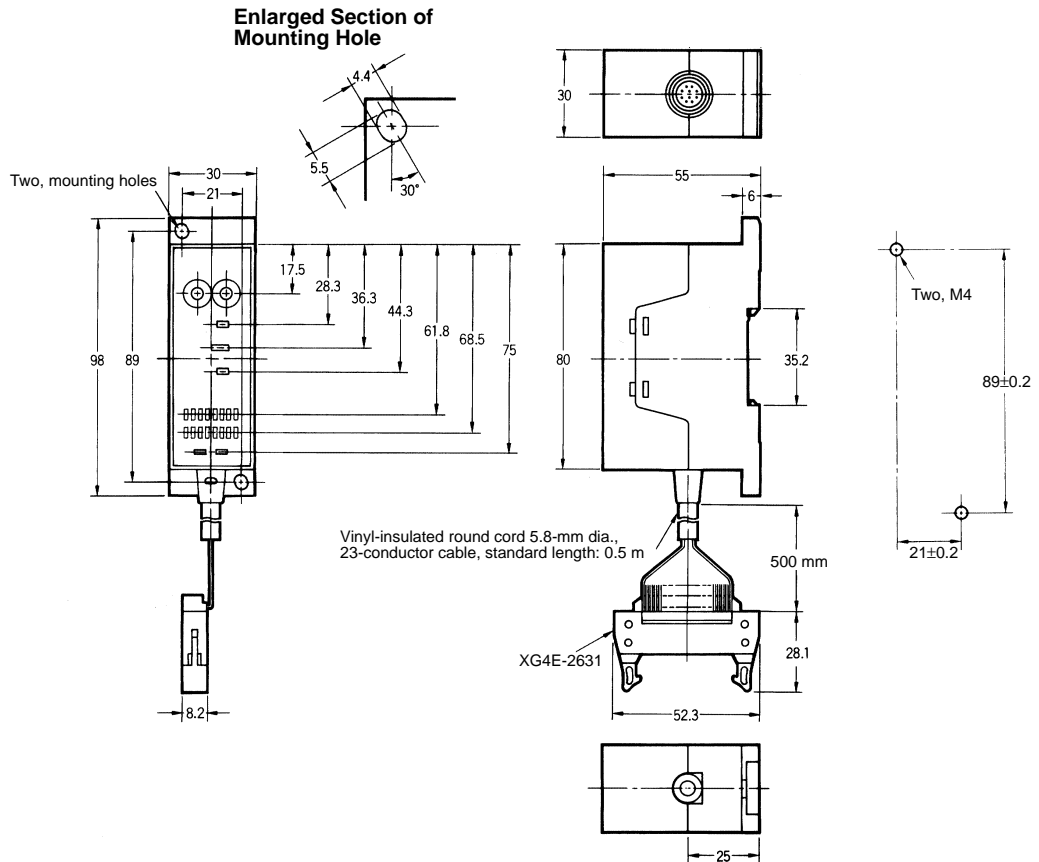
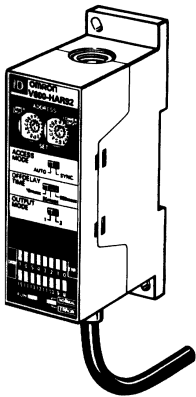

V600-HAR91

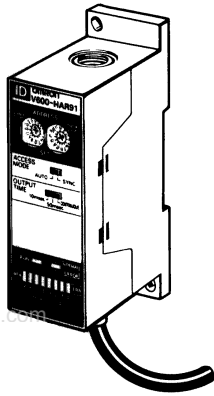

Enlarged Section of Mounting Hole

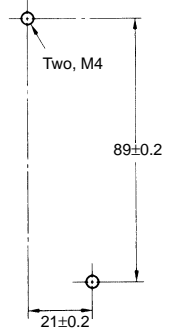
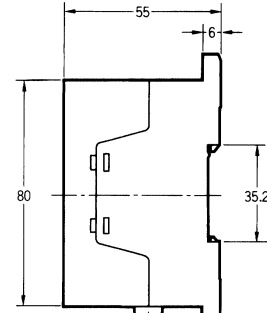
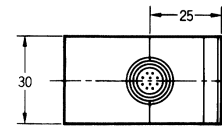
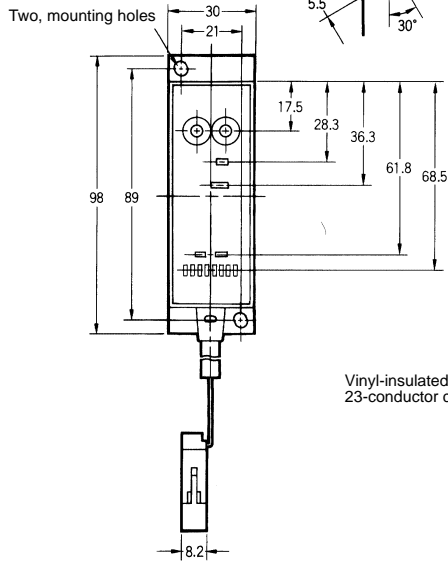

Vinyl-insulated round cord 5.8-mm dia., 23-conductor cable, standard length: 0.5 m

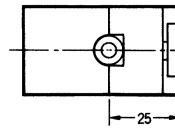
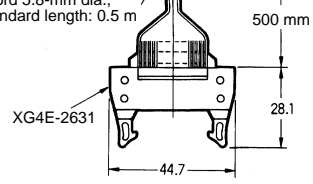

V600-HAM91

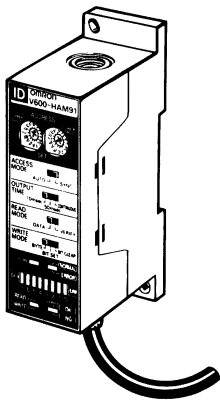

Enlarged Section of Mounting Hole

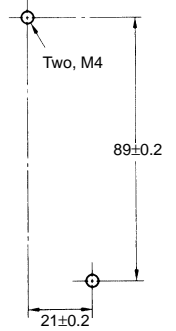
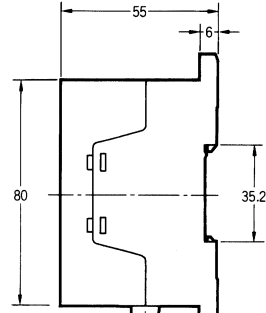
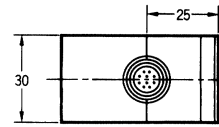
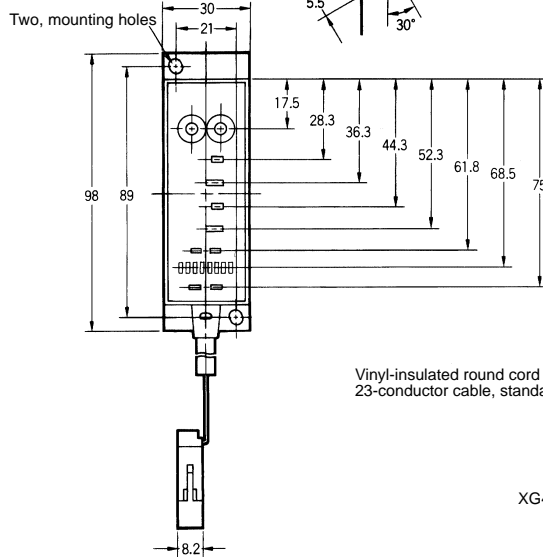

Vinyl-insulated round cord 5.8-mm dia., 23-conductor cable, standard length: 0.5 m

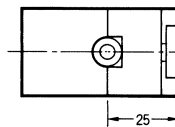
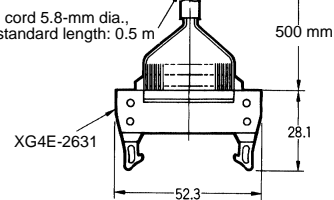

Sensor

V600-HS51

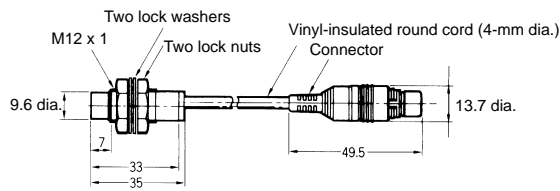

Case: Brass
Transmission window: ABS resin
Filter: Epoxy resin
Cable: PVC (oil-resistant)

V600-HS61

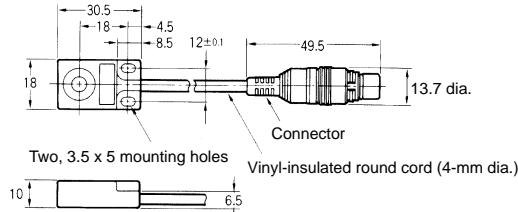

Case: ABS resin
Filter: Epoxy resin
Cable: PVC (oil-resistant)

V600-HS63

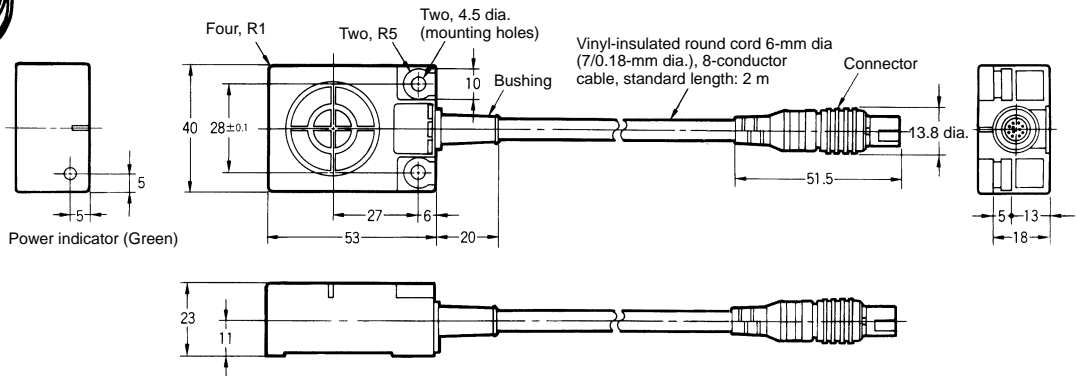
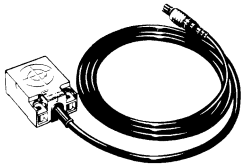

Case: ABS resin
Filter: Epoxy resin
Cable: PVC (oil-resistant)

Power indicator (Green)

Interface Cable

V600-A6□R

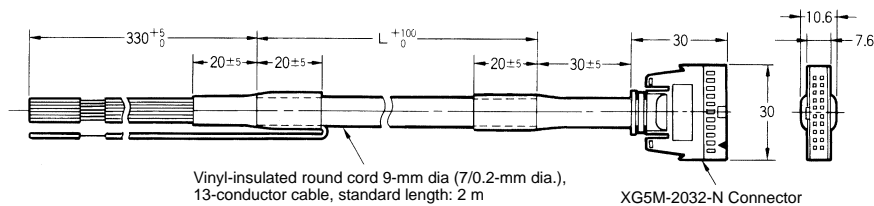
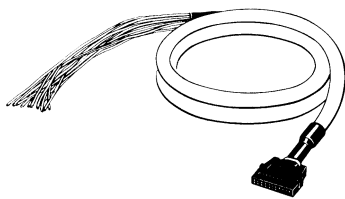

V600-A6□M

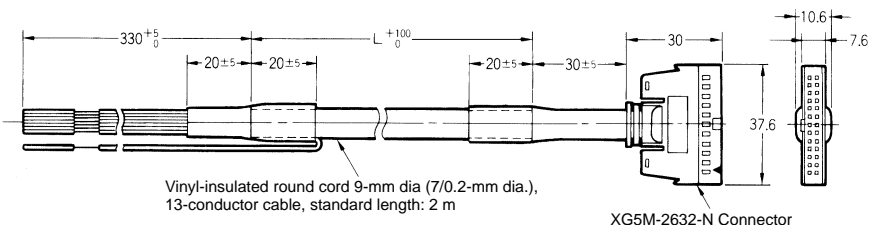
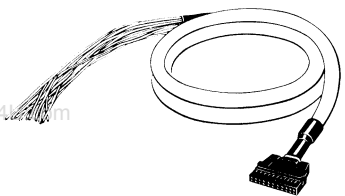

Model	L
V600-A60R/60M	2,000 mm
V600-A61R/61M	5,000 mm
V600-A62R/62M	10,000 mm

Precautions

⚠ Caution

1. Be sure to house the V600-HA□91/-HA□92 together with their connectors and cable in control boxes when using them and do not expose them to water, oil, dust, metal powder, corrosive gas, or organic solvent, otherwise they may malfunction, suffer damage, or burn.
2. The connectors of the V600-HA□91/-HA□92 can be mounted to metal plates, provided that there is an insulation plate with a thickness of 1.5 mm minimum between each of the connectors and metal plates.

Input/Output

The Data Input and Data Output lines are set to "1" when the transistor turns ON and to "0" when it turns OFF.

Do not use a solid-state output with the following ratings with the V600-HAM91, otherwise an external input error may result.

1. Maximum switching current: 1 A min.
2. Minimum switching current: 10 mA min.
3. Response time (ON to OFF): 3 ms min.

The following OMRON products cannot be connected to the V600-HA□91 or V600-HA□92.

- CVM1-OD219, C20H, C28H, C40H, or C60H Programmable Controllers
- Sensor Controllers other than from the S3D2 Series

When using a contact output, pay careful attention to chattering and to the minimum switching current. Also note that the minimum switching current may be specified for some solid-state outputs.

When connecting an inductive load or an electrical device that tends to generate noise to the output, connect a diode in parallel with the load. Connect the cathode side of the diode to the positive side of the power source.

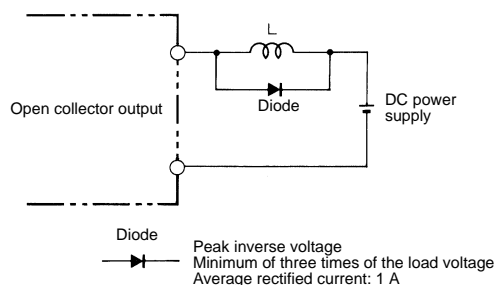

Power Supply Voltage

Do not impose 100 VAC or any voltage exceeding the rated voltage range on the V600-HA□91 or V600-HA□92, otherwise the V600-HA□91 or V600-HA□92 may explode or burn.

Load Short-circuiting

Do not short-circuit the load connected to the V600-HA□91 or V600-HA□92 or connect power to the load, otherwise the V600-HA□91 or V600-HA□92 may explode or burn.

Wiring

Avoid a wiring mistake by paying attention to the polarity of the power supply connected to the V600-HA□91 or V600-HA□92, otherwise the V600-HA□91 or V600-HA□92 may explode or burn.

Correct Use

Grounding

The FG line is provided for grounding to the earth. When using the Amplifier in an environment where it is exposed to large amounts of noise or if the V600-HA□91 Amplifier malfunctions, provide a Class-3 ground (ground resistance of 100 Ω or less). Note that sharing the grounding wire with other equipment or grounding to the beam of a building will adversely affect the grounding effect.

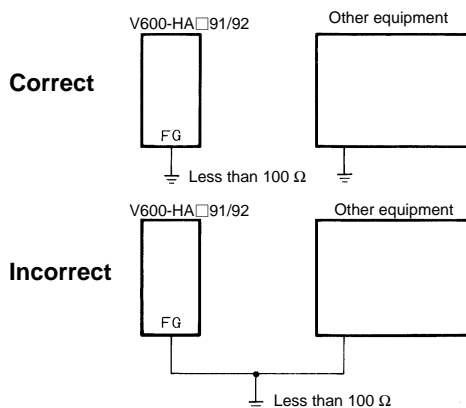

Mounting

Amplifier Spacing

When installing V600-HA□91/V600-HA□92 Amplifiers in a row, provide a minimum space of 10 mm between Amplifiers in order to prevent them from being affected by the heat produced by each Amplifier.

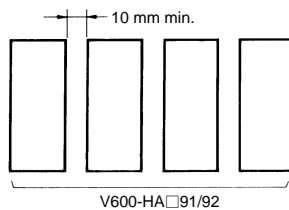

When housing the Amplifiers in a box, provide a fan or ventilation opening for radiating the heat.

When wiring power cables, which carry large current such as motor drive cables, near the V600-HA□91/92 Amplifiers, conduct necessary tests to make sure that the installation conditions are fully satisfied.

The Amplifiers and Connectors for interface cable connections are not waterproof. Be sure to house them in a control box when using them in a location where they are exposed to water or oil.

I/O Interface Requirements

The TRG input must be 10 ms min.

The INHIBIT input must be 20 ms min.

Minimum of 5 ms is required as the transfer time of the Read/Write Selection Input (W/R).

The read data output must be read after the Normal End Output is set to ON.

Connecting the Sensor

Hold the black part of the connector, line up the notch and push it in until it clicks.

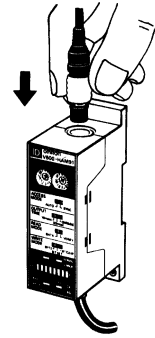

Comparability with the SRAM Memory Type Data Carrier

If the Data Carrier is stationary in the transmission area for a long time in the AUTO mode, this will drastically reduce the battery life. Therefore, stop the oscillation in the sensor either by turning off the power of the V600-HA□91/92 Amplifier or by setting the Inhibit input to ON.

Use a Data Carrier that has the oscillation frequency of 530 kHz. Note that the following models manufactured before February 1991 cannot be used.

- V600-D2KR01
- V600-D2KR02

Precautions When Using the AUTO Mode

If transmitting to the Data Carrier while it is traveling under the AUTO mode, conduct tests to make sure that the travel speed and installation conditions are fully satisfied.