

## Dual High Voltage Trench MOS Barrier Schottky Rectifier

Ultra Low  $V_F = 0.42\text{ V}$  at  $I_F = 5\text{ A}$

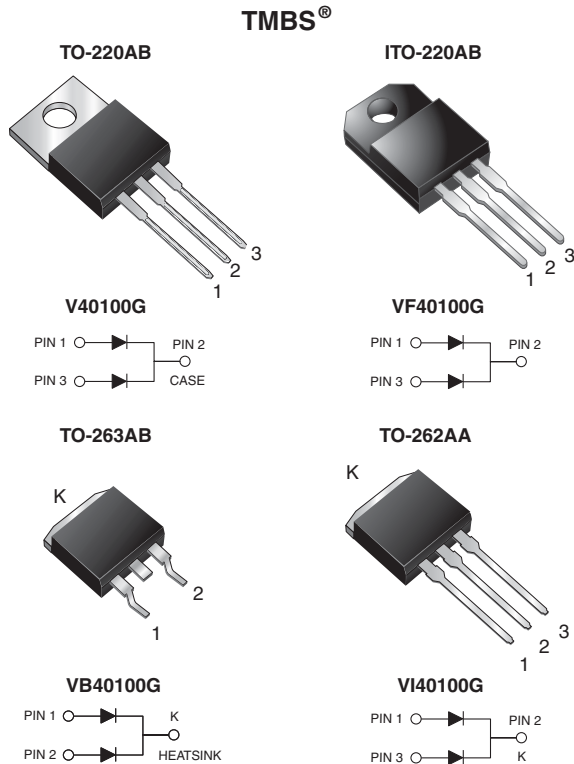

### FEATURES

- Trench MOS Schottky technology
- Low forward voltage drop, low power losses
- High efficiency operation
- Low thermal resistance
- Meets MSL level 1, per J-STD-020, LF maximum peak of 245 °C (for TO-263AB package)
- Solder bath temperature 275 °C maximum, 10 s, per JESD 22-B106 (for TO-220AB, ITO-220AB, and TO-262AA package)
- Material categorization: For definitions of compliance please see [www.vishay.com/doc?99912](http://www.vishay.com/doc?99912)



**RoHS**  
COMPLIANT

### TYPICAL APPLICATIONS

For use in high frequency converters, switching power supplies, freewheeling diodes, OR-ing diode, DC/DC converters and reverse battery protection.

### MECHANICAL DATA

**Case:** TO-220AB, ITO-220AB, TO-263AB and TO-262AA

Molding compound meets UL 94 V-0 flammability rating

Base P/N-E3 - RoHS-compliant, commercial grade

**Terminals:** Matte tin plated leads, solderable per J-STD-002 and JESD 22-B102

E3 suffix meets JESD 201 class 1A whisker test

**Polarity:** As marked

**Mounting Torque:** 10 in-lbs maximum

### PRIMARY CHARACTERISTICS

|                              |  |
|------------------------------|--|
| $I_{F(AV)}$                  | 2 x 20 A                                   |
| $V_{RRM}$                    | 100 V                                      |
| $I_{FSM}$                    | 200 A                                      |
| $V_F$ at $I_F = 20\text{ A}$ | 0.67 V                                     |
| $T_J$ max.                   | 150 °C                                     |
| Package                      | TO-220AB, ITO-220AB,<br>TO-263AB, TO-262AA |
| Diode variations             | Common cathode                             |

### MAXIMUM RATINGS ( $T_A = 25\text{ °C}$ unless otherwise noted)

| PARAMETER   | SYMBOL         | V40100G     | VF40100G | VB40100G | VI40100G | UNIT             |   |
|---|----------------|-------------|----------|----------|----------|------------------|---|
| Maximum repetitive peak reverse voltage   | $V_{RRM}$      | 100         |          |          |          | V                |   |
| Maximum average forward rectified current (fig. 1)  | $I_{F(AV)}$    | per device  |          |          |          | 40               | A |
|   |                | per diode   |          |          |          | 20               |   |
| Peak forward surge current 8.3 ms single half sine-wave superimposed on rated load per diode                            | $I_{FSM}$      | 200         |          |          |          | A                |   |
| Non-repetitive avalanche energy at $T_J = 25\text{ °C}$ , $L = 90\text{ mH}$ per diode                                  | $E_{AS}$       | 230         |          |          |          | mJ               |   |
| Peak repetitive reverse current at $t_p = 2\text{ }\mu\text{s}$ , 1 kHz, $T_J = 38\text{ °C} \pm 2\text{ °C}$ per diode | $I_{RRM}$      | 1.0         |          |          |          | A                |   |
| Voltage rate of change (rated $V_R$ )   | dV/dt          | 10 000      |          |          |          | V/ $\mu\text{s}$ |   |
| Isolation voltage (ITO-220AB only) from terminal to heatsink $t = 1\text{ min}$   | $V_{AC}$       | 1500        |          |          |          | V                |   |
| Operating junction and storage temperature range  | $T_J, T_{STG}$ | -40 to +150 |          |          |          | °C               |   |



| ELECTRICAL CHARACTERISTICS (T <sub>A</sub> = 25 °C unless otherwise noted) |                         |                         |                 |          |      |      |
|--|-------------------------|-------------------------|-----------------|----------|------|------|
| PARAMETER  | TEST CONDITIONS         |                         | SYMBOL          | TYP.     | MAX. | UNIT |
| Breakdown voltage  | I <sub>R</sub> = 1.0 mA | T <sub>A</sub> = 25 °C  | V <sub>BR</sub> | 100 min. | -    | V    |
| Instantaneous forward voltage per diode <sup>(1)</sup>                     | I <sub>F</sub> = 5 A    | T <sub>A</sub> = 25 °C  | V <sub>F</sub>  | 0.49     | -    |      |
|  | I <sub>F</sub> = 10 A   |                         |                 | 0.59     | -    |      |
|  | I <sub>F</sub> = 20 A   |                         |                 | 0.75     | 0.81 |      |
|  | I <sub>F</sub> = 5 A    | T <sub>A</sub> = 125 °C |                 | 0.42     | -    |      |
|  | I <sub>F</sub> = 10 A   |                         |                 | 0.54     | -    |      |
|  | I <sub>F</sub> = 20 A   |                         |                 | 0.67     | 0.73 |      |
| Reverse current per diode <sup>(2)</sup>                                   | V <sub>R</sub> = 70 V   | T <sub>A</sub> = 25 °C  | I <sub>R</sub>  | 12       | -    | μA   |
|  |                         | T <sub>A</sub> = 125 °C |                 | 8        | -    | mA   |
|  | V <sub>R</sub> = 100 V  | T <sub>A</sub> = 25 °C  |                 | 55       | 500  | μA   |
|  |                         | T <sub>A</sub> = 125 °C |                 | 21       | 35   | mA   |

**Notes**

- (1) Pulse test: 300 μs pulse width, 1 % duty cycle
- (2) Pulse test: Pulse width ≤ 40 ms

| THERMAL CHARACTERISTICS (T <sub>A</sub> = 25 °C unless otherwise noted) |                  |         |          |          |          |      |
|---|------------------|---------|----------|----------|----------|------|
| PARAMETER   | SYMBOL           | V40100G | VF40100G | VB40100G | VI40100G | UNIT |
| Typical thermal resistance per diode                                    | R <sub>θJC</sub> | 2.0     | 5.0      | 2.0      | 2.0      | °C/W |

| ORDERING INFORMATION (Example) |                |                 |              |               |               |
|--------------------------------|----------------|-----------------|--------------|---------------|---------------|
| PACKAGE                        | PREFERRED P/N  | UNIT WEIGHT (g) | PACKAGE CODE | BASE QUANTITY | DELIVERY MODE |
| TO-220AB                       | V40100G-E3/4W  | 1.88            | 4W           | 50/tube       | Tube          |
| ITO-220AB                      | VF40100G-E3/4W | 1.75            | 4W           | 50/tube       | Tube          |
| TO-263AB                       | VB40100G-E3/4W | 1.39            | 4W           | 50/tube       | Tube          |
| TO-263AB                       | VB40100G-E3/8W | 1.39            | 8W           | 800/reel      | Tape and reel |
| TO-262AA                       | VI40100G-E3/4W | 1.46            | 4W           | 50/tube       | Tube          |

**RATINGS AND CHARACTERISTICS CURVES (T<sub>A</sub> = 25 °C unless otherwise noted)**

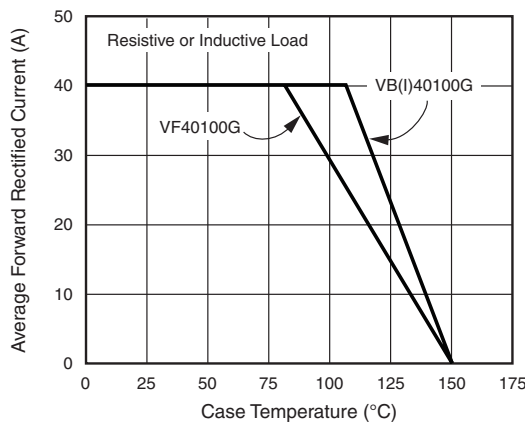

Fig. 1 - Maximum Forward Current Derating Curve

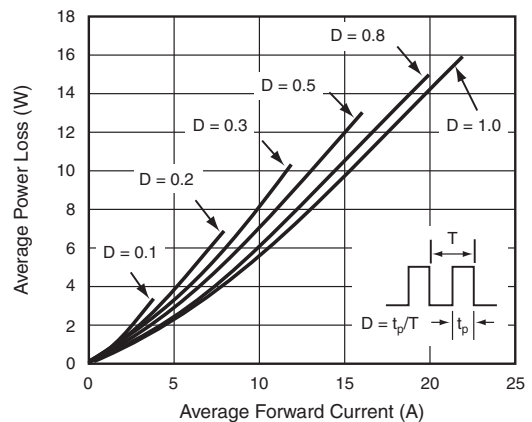

Fig. 2 - Forward Power Loss Characteristics

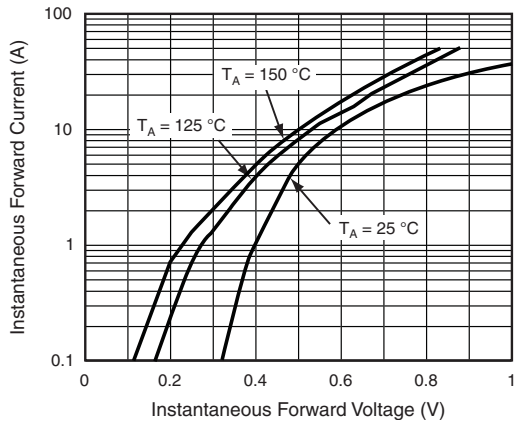

Fig. 3 - Typical Instantaneous Forward Characteristics

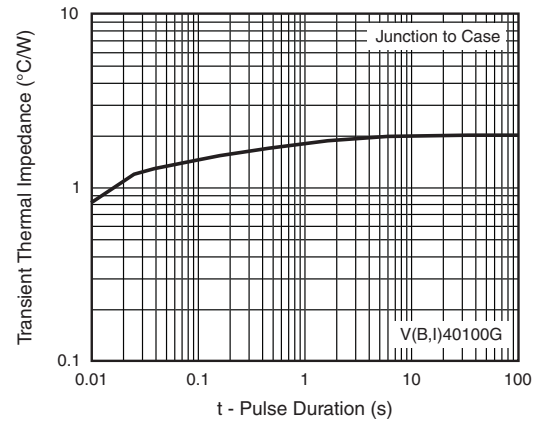

Fig. 6 - Typical Transient Thermal Impedance

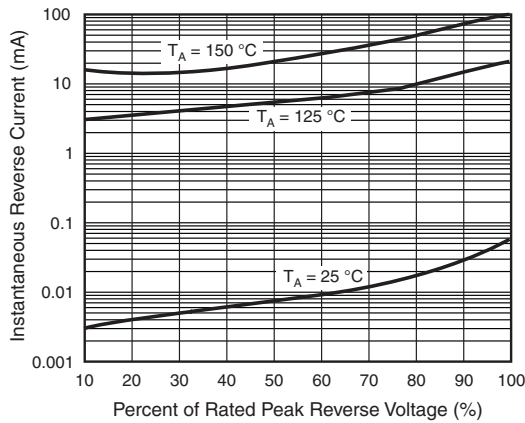

Fig. 4 - Typical Reverse Characteristics

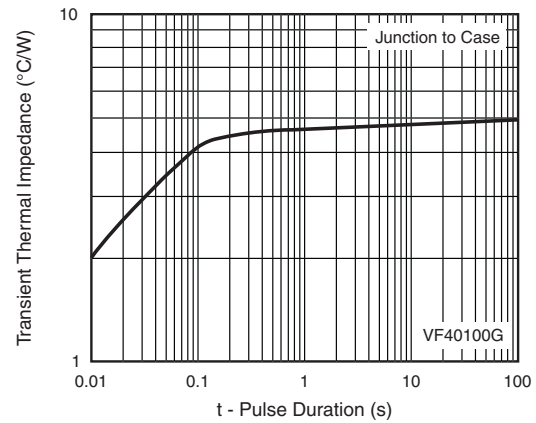

Fig. 7 - Typical Transient Thermal Impedance

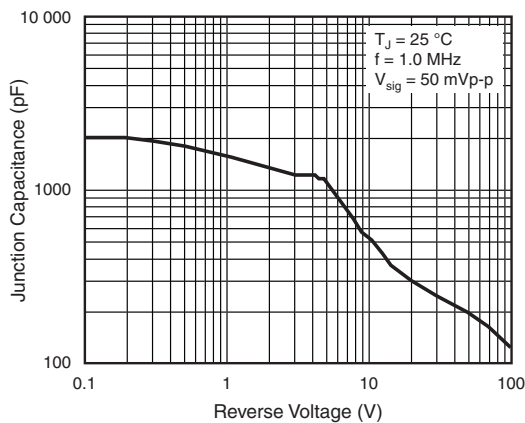
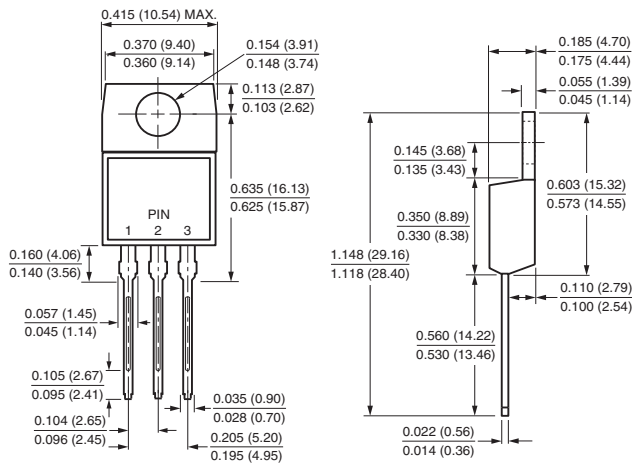

Fig. 5 - Typical Junction Capacitance



## PACKAGE OUTLINE DIMENSIONS in inches (millimeters)

### TO-220AB



### ITO-220AB

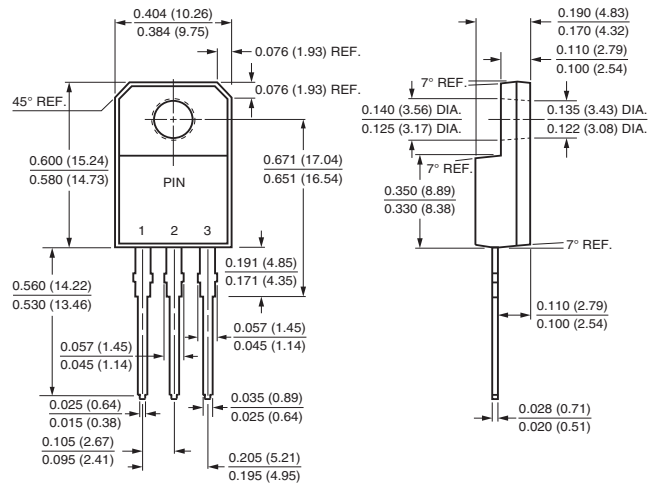

### TO-262AA

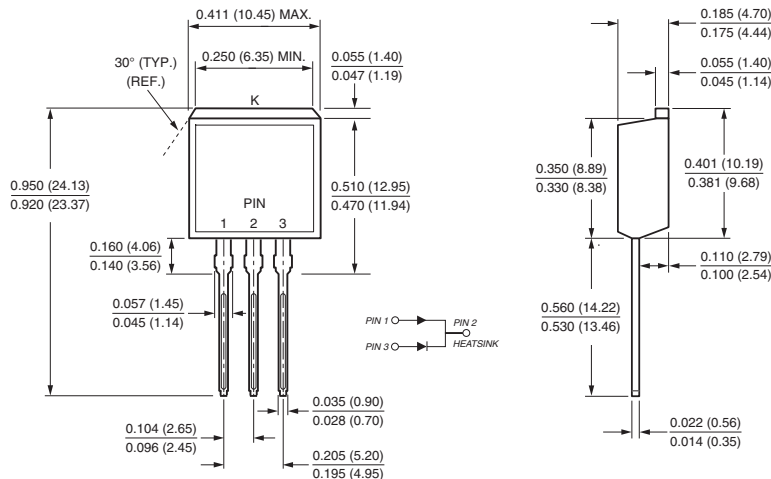

### TO-263AB

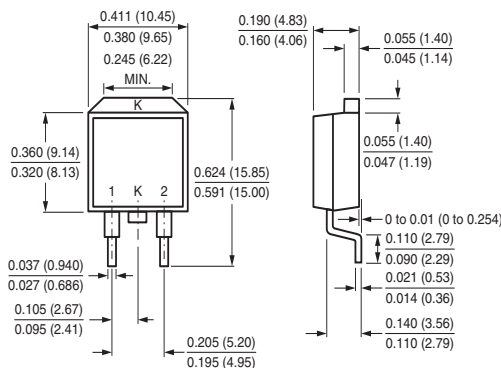

### Mounting Pad Layout

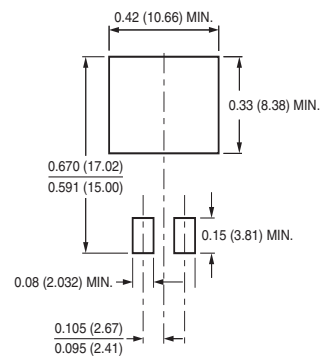



## Disclaimer

ALL PRODUCT, PRODUCT SPECIFICATIONS AND DATA ARE SUBJECT TO CHANGE WITHOUT NOTICE TO IMPROVE RELIABILITY, FUNCTION OR DESIGN OR OTHERWISE.

Vishay Intertechnology, Inc., its affiliates, agents, and employees, and all persons acting on its or their behalf (collectively, "Vishay"), disclaim any and all liability for any errors, inaccuracies or incompleteness contained in any datasheet or in any other disclosure relating to any product.

Vishay makes no warranty, representation or guarantee regarding the suitability of the products for any particular purpose or the continuing production of any product. To the maximum extent permitted by applicable law, Vishay disclaims (i) any and all liability arising out of the application or use of any product, (ii) any and all liability, including without limitation special, consequential or incidental damages, and (iii) any and all implied warranties, including warranties of fitness for particular purpose, non-infringement and merchantability.

Statements regarding the suitability of products for certain types of applications are based on Vishay's knowledge of typical requirements that are often placed on Vishay products in generic applications. Such statements are not binding statements about the suitability of products for a particular application. It is the customer's responsibility to validate that a particular product with the properties described in the product specification is suitable for use in a particular application. Parameters provided in datasheets and/or specifications may vary in different applications and performance may vary over time. All operating parameters, including typical parameters, must be validated for each customer application by the customer's technical experts. Product specifications do not expand or otherwise modify Vishay's terms and conditions of purchase, including but not limited to the warranty expressed therein.

Except as expressly indicated in writing, Vishay products are not designed for use in medical, life-saving, or life-sustaining applications or for any other application in which the failure of the Vishay product could result in personal injury or death. Customers using or selling Vishay products not expressly indicated for use in such applications do so at their own risk. Please contact authorized Vishay personnel to obtain written terms and conditions regarding products designed for such applications.

No license, express or implied, by estoppel or otherwise, to any intellectual property rights is granted by this document or by any conduct of Vishay. Product names and markings noted herein may be trademarks of their respective owners.

## Material Category Policy

**Vishay Intertechnology, Inc. hereby certifies that all its products that are identified as RoHS-Compliant fulfill the definitions and restrictions defined under Directive 2011/65/EU of The European Parliament and of the Council of June 8, 2011 on the restriction of the use of certain hazardous substances in electrical and electronic equipment (EEE) - recast, unless otherwise specified as non-compliant.**

**Please note that some Vishay documentation may still make reference to RoHS Directive 2002/95/EC. We confirm that all the products identified as being compliant to Directive 2002/95/EC conform to Directive 2011/65/EU.**

**Vishay Intertechnology, Inc. hereby certifies that all its products that are identified as Halogen-Free follow Halogen-Free requirements as per JEDEC JS709A standards. Please note that some Vishay documentation may still make reference to the IEC 61249-2-21 definition. We confirm that all the products identified as being compliant to IEC 61249-2-21 conform to JEDEC JS709A standards.**