

Standard Rectifier Module

1~ Rectifier	
V_{RRM}	= 1800 V
I_{DAV}	= 45 A
I_{FSM}	= 750 A

1~ Rectifier Bridge

Part number

VBO50-18NO7

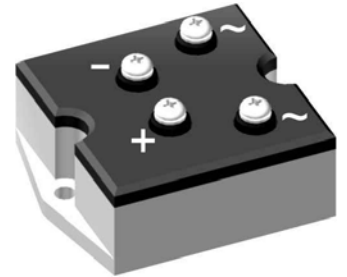

 E72873

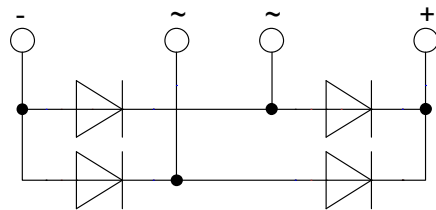

Features / Advantages:

- Package with DCB ceramic
- Improved temperature and power cycling
- Planar passivated chips
- Very low forward voltage drop
- Very low leakage current

Applications:

- Diode for main rectification
- For one phase bridge configurations
- Supplies for DC power equipment
- Input rectifiers for PWM inverter
- Battery DC power supplies
- Field supply for DC motors

Package: PWS-B

- Industry standard outline
- RoHS compliant
- Easy to mount with two screws
- Base plate: Aluminium internally DCB isolated
- Advanced power cycling

Rectifier				Ratings		
Symbol	Definition	Conditions	min.	typ.	max.	Unit
V_{RSM}	max. non-repetitive reverse blocking voltage	$T_{VJ} = 25^{\circ}C$			1900	V
V_{RRM}	max. repetitive reverse blocking voltage	$T_{VJ} = 25^{\circ}C$			1800	V
I_R	reverse current	$V_R = 1800 V$	$T_{VJ} = 25^{\circ}C$		100	μA
		$V_R = 1800 V$	$T_{VJ} = 150^{\circ}C$		1.5	mA
V_F	forward voltage drop	$I_F = 20 A$	$T_{VJ} = 25^{\circ}C$		1.03	V
		$I_F = 40 A$			1.14	V
		$I_F = 20 A$	$T_{VJ} = 125^{\circ}C$		0.92	V
		$I_F = 40 A$			1.06	V
I_{DAV}	bridge output current	$T_C = 85^{\circ}C$ rectangular $d = 0.5$	$T_{VJ} = 150^{\circ}C$		45	A
V_{FO}	threshold voltage	} for power loss calculation only	$T_{VJ} = 150^{\circ}C$		0.76	V
r_F	slope resistance				6.9	m Ω
R_{thJC}	thermal resistance junction to case				2.7	K/W
R_{thCH}	thermal resistance case to heatsink			0.4		K/W
P_{tot}	total power dissipation		$T_C = 25^{\circ}C$		46	W
I_{FSM}	max. forward surge current	$t = 10 \text{ ms}; (50 \text{ Hz}), \text{ sine}$	$T_{VJ} = 45^{\circ}C$		750	A
		$t = 8,3 \text{ ms}; (60 \text{ Hz}), \text{ sine}$	$V_R = 0 V$		810	A
		$t = 10 \text{ ms}; (50 \text{ Hz}), \text{ sine}$	$T_{VJ} = 150^{\circ}C$		640	A
		$t = 8,3 \text{ ms}; (60 \text{ Hz}), \text{ sine}$	$V_R = 0 V$		690	A
I^2t	value for fusing	$t = 10 \text{ ms}; (50 \text{ Hz}), \text{ sine}$	$T_{VJ} = 45^{\circ}C$		2.82	kA ² s
		$t = 8,3 \text{ ms}; (60 \text{ Hz}), \text{ sine}$	$V_R = 0 V$		2.73	kA ² s
		$t = 10 \text{ ms}; (50 \text{ Hz}), \text{ sine}$	$T_{VJ} = 150^{\circ}C$		2.05	kA ² s
		$t = 8,3 \text{ ms}; (60 \text{ Hz}), \text{ sine}$	$V_R = 0 V$		1.98	kA ² s
C_J	junction capacitance	$V_R = 400 V; f = 1 \text{ MHz}$	$T_{VJ} = 25^{\circ}C$		10	pF

Package PWS-B			Ratings			
Symbol	Definition	Conditions	min.	typ.	max.	Unit
I_{RMS}	RMS current	per terminal			100	A
T_{stg}	storage temperature		-40		125	°C
T_{VJ}	virtual junction temperature		-40		150	°C
Weight				193		g
M_D	mounting torque		4.25		5.75	Nm
M_T	terminal torque		2.5		3.5	Nm
$d_{Spp/App}$	creepage distance on surface striking distance through air	terminal to terminal	11.0			mm
$d_{Spb/Appb}$		terminal to backside	7.5			mm
V_{ISOL}	isolation voltage	t = 1 second	3000			V
		t = 1 minute	2500			V

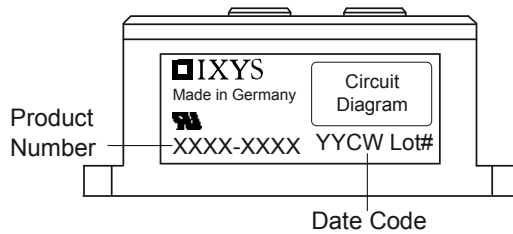

Ordering	Part Number	Marking on Product	Delivery Mode	Quantity	Code No.
Standard	VBO50-18NO7	VBO50-18NO7	Box	10	483176

Equivalent Circuits for Simulation

* on die level

$T_{VJ} = 150\text{ °C}$

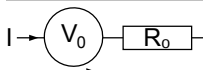

Rectifier

$V_{0\ max}$	threshold voltage	0.76	V
$R_{0\ max}$	slope resistance *	5.7	mΩ

Outlines PWS-B

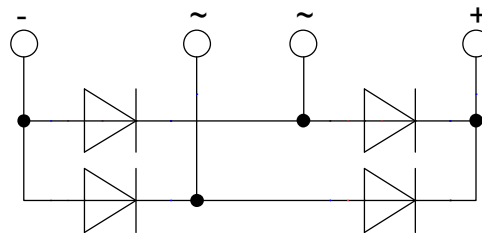
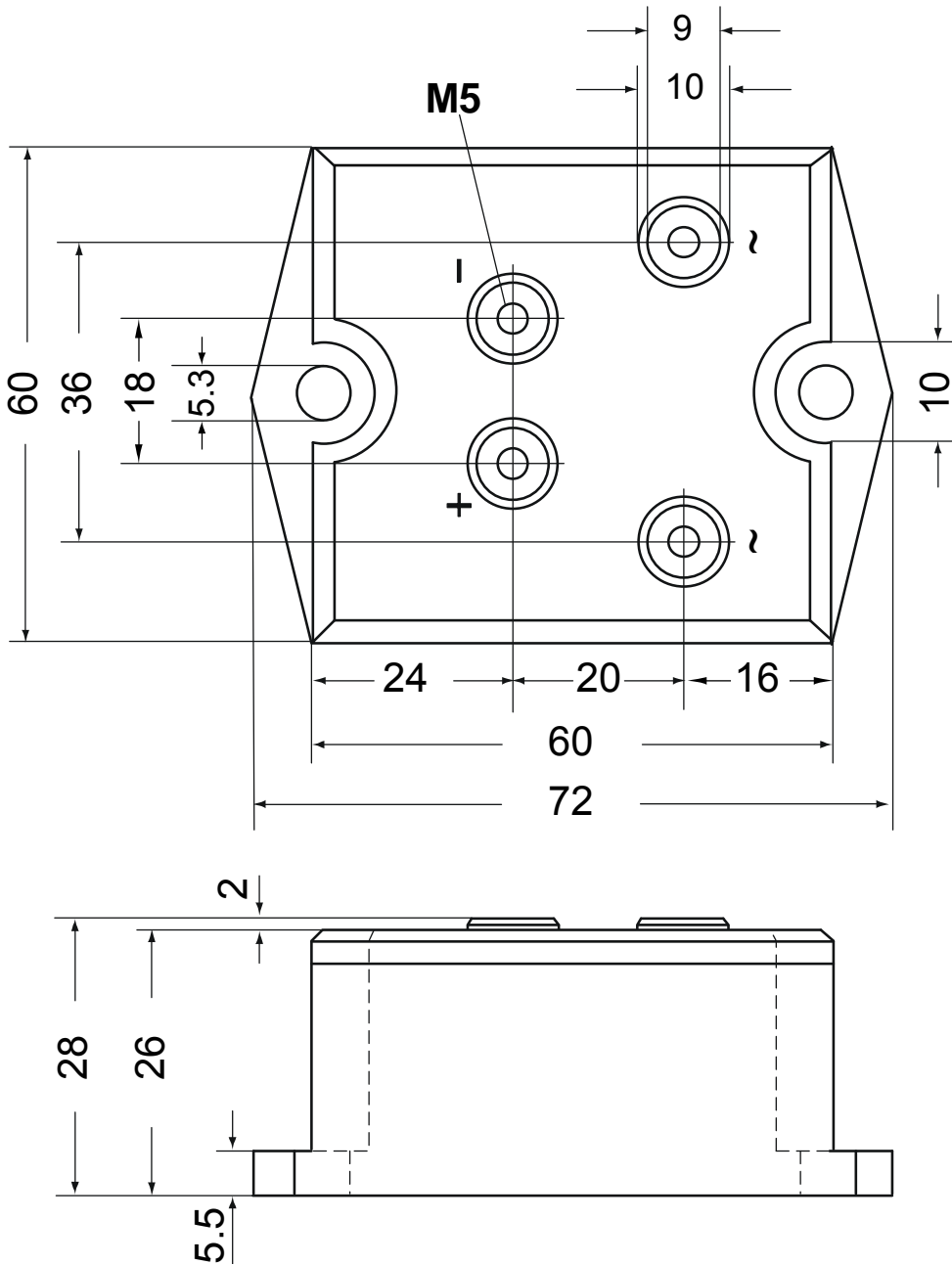

Rectifier

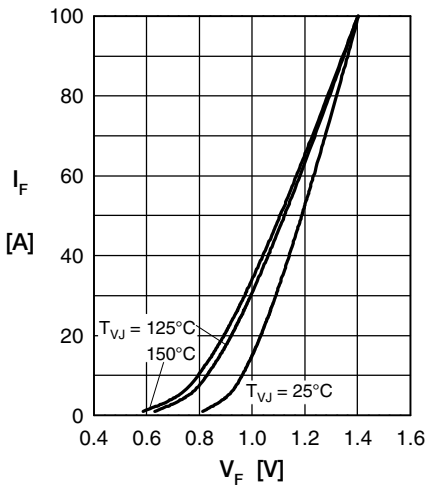

Fig. 1 Forward current vs. voltage drop per diode

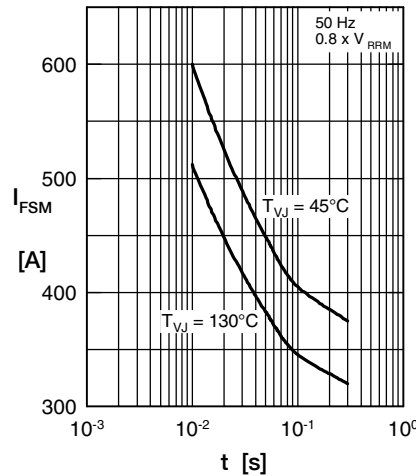

Fig. 2 Surge overload current vs. time per diode

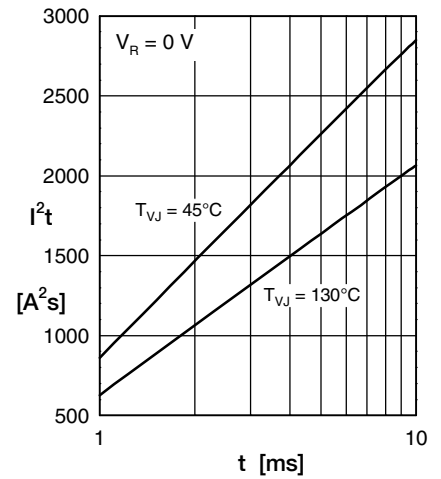

Fig. 3 I^2t vs. time per diode

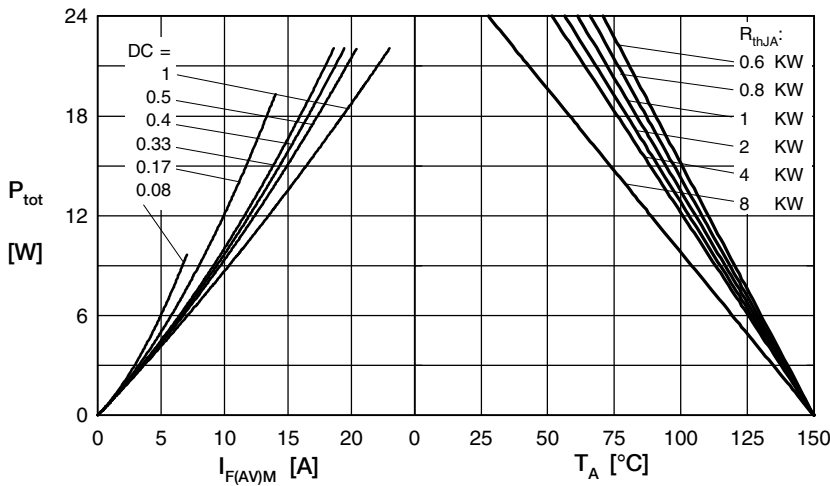

Fig. 4 Power dissipation vs. forward current and ambient temperature per diode

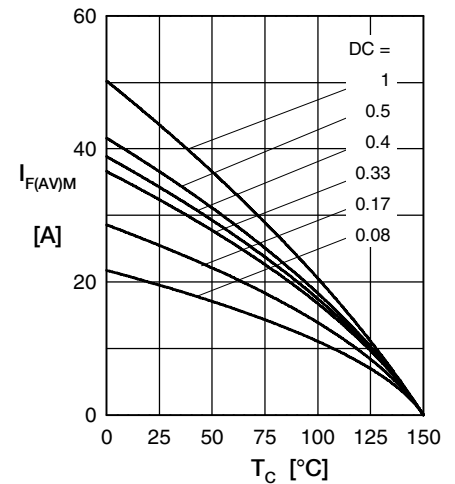

Fig. 5 Max. forward current vs. case temperature per diode

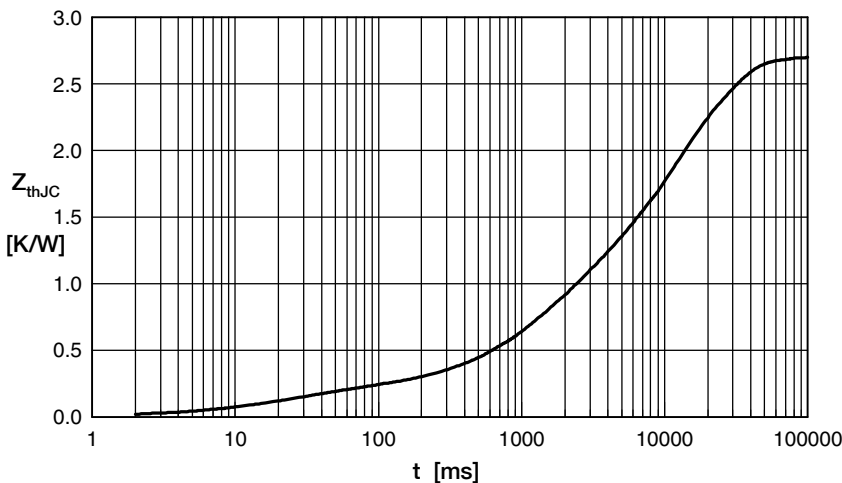

Fig. 6 Transient thermal impedance junction to case vs. time per diode

Constants for Z_{thJC} calculation:

i	R_{th} (K/W)	t_i (s)
1	0.040	0.010
2	0.150	0.030
3	0.610	1.350
4	1.900	14.00