

POWER RELAY

1 POLE - 20/25/30A - Heavy power control

VF Series

■ FEATURES

- UL, CSA, VDE recognized TV-15 rated
 - 1 form A contact (SPST-NO)
 - Heavy duty 20 to 30A small power relay
 - High inrush current and high surge voltage
 - Inrush current 65A
 - Surge strength 10,000V
 - Printed circuit coil terminals type available
 - Small package meets high density mounting requirement
 - Flux proof sealing, RTII
 - RoHS Compliant
- Please see page 7 for more information



■ PARTNUMBER INFORMATION

[Example] VF B - 6 H U
 (a) (b) (*) (c) (d) (e)

(a)	Relay type	VF	: VF-Series
(b)	Terminal	Nil B D P	: Top - All tab-terminal : Top - Tab terminal (contacts) Bottom - PCB terminal (coil and movable contact) : Top - Tab terminal (coil) Screw tight terminal (contacts) : Top - Screw tight terminal (contacts) Bottom - PCB terminal (coil and movable contact)
(c)	Coil rated voltage	6	: 3.....60 VDC Coil rating table at page 3
(d)	Contact rating	H M L	: 30A (applicable for D.P.) : 25A : 20A
(e)	Approvals	U	: UL, CSA, VDE rating acquired

Note: Actual marking omits hyphen (-) of (*)

■ SPECIFICATION

Item			30A type	25A type	20A type	
			VFD, VFP - () H	VF () - () M	VF () - () L	
Contact Data	Configuration		1 form A (SPST-NO)			
	Construction		Single			
	Material		Silver alloy (AgSnO ₂ ; AgSnOInO)			
	Resistance (initial)		Max. 30mΩ at 1A, 6VDC			
	Contact rating	Resistive		30A, 250VAC	25A, 250VAC	20A, 250VAC
		Motor		2HP, 250VAC	1.5HP, 250VAC	1HP, 250VAC
	Max. carrying current			30A	25A	20A
	Max. switching voltage			250VAC		
	Max. switching power			7,500VA	6,250VA	5,000VA
	Max. switching current			30A	25A	20A
Min. switching load *			1A, 10V			
Life	Mechanical		Min. 5 x 10 ⁶ operations			
	Electrical (at contact rating)	Resistive load	Min. 100 x 10 ³ operations			
		Motor load	Min. 200 x 10 ³ operations			
Coil Data	Rated Power (at 20 ° C)		1,200 to 1,250mW			
	Operate Power (at 20 ° C)		590 to 620mW			
	Operating temperature range		-30 to +65 ° C (no frost)			
Timing Data	Operate (at nominal voltage)		Max. 20ms			
	Release (at nominal voltage)		Max. 5ms (without diode)			
Insulation	Resistance (Initial)		Min. 1,000MΩ at 500VDC			
	Dielectric strength	Open contacts	1,200VAC (50/60Hz) 1min.			
		Coil and contacts	4,000VAC (50/60Hz) 1min.			
Surge strength		Coil and contacts	10.000V/ 1.2 x 50μs standard wave			
Other	Vibration Resistance	Misoperation	10 to 55Hz double amplitude 1.5mm			
		Endurance	10 to 55Hz double amplitude 1.5mm			
	Shock	Misoperation	Min. 200m/s ² (11 ± 1ms)			
		Endurance	Min. 1,000m/s ² (6 ± 1ms)			
	Weight		Approximately 55 g			
Sealing		Flux proof (RTII)				

* Minimum switching loads mentioned above are reference values. Please perform the confirmation test with actual load before production since reference values may vary according to switching frequencies, environmental conditions and expected reliability levels.

■ **COIL RATING**

Coil Code	Rated Coil Voltage (VDC)	Coil Resistance +/- 10% (Ohm)	Must Operate Voltage (VDC) *	Must Release Voltage (VDC) *	Rated Power (mW)
3	3	7.5	2.1	0.3	1,200
5	5	20	3.5	0.5	1,250
6	6	30	4.2	0.6	1,200
9	9	67	6.3	0.9	
12	12	120	8.4	1.2	
18	18	270	12.6	1.8	
24	24	480	16.8	2.4	
48	48	1,920	33.6	4.8	
60	60	3,000	42.0	6.0	

Note: All values in the table are valid for 20°C and zero contact current.

* Specified operate values are valid for pulse wave voltage.

■ **SAFETY STANDARDS**

Type	Compliance	Contact rating
UL	UL 508 873	Flammability: UL 94-V0 (plastics)
	E56140	VF - () - () L 20A, 250VAC (resistive)
CSA	C22.2 No. 14 LR 35579	1HP, 250VAC/125VAC TV-15, 120VAC
		VF - () - () M 25A, 250VAC (resistive) 1.5HP, 250VAC TV-15, 120VAC VFD, VFP - () - H 30A, 250VAC (resistive) 2HP, 250VAC TV-15, 120VAC
VDE	0435 40017717	VF-(-;B)-LU: 20A, 250VAC resistive: 100K 15A, 250VAC cos φ 0.7: 100K VF-(-;B)-HU: 30A, 250VAC resistive: 100K 22.5A, 250VAC cos φ 0.7: 100K

CHARACTERISTIC DATA

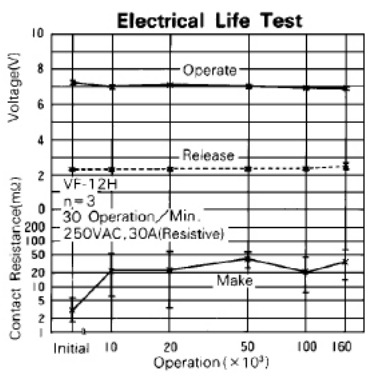
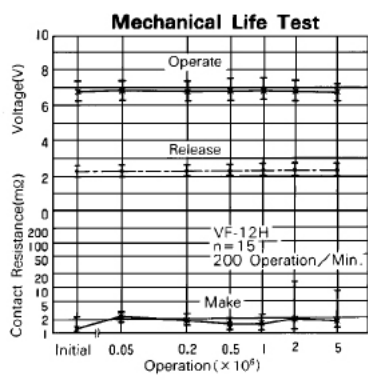
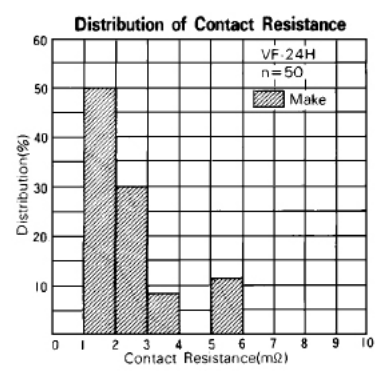
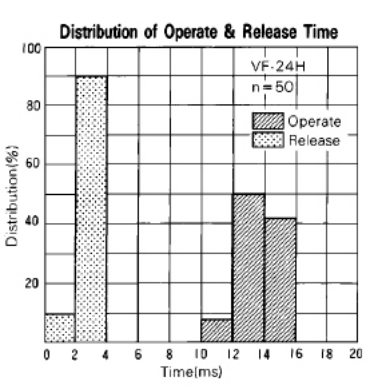
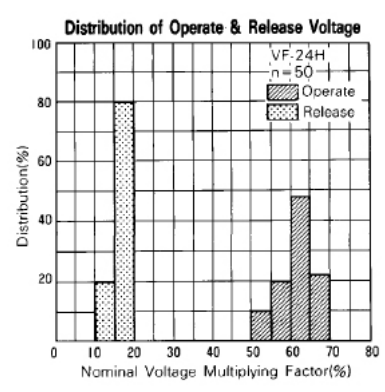
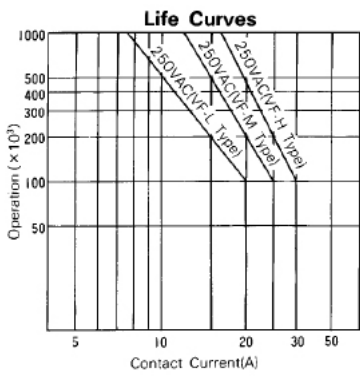
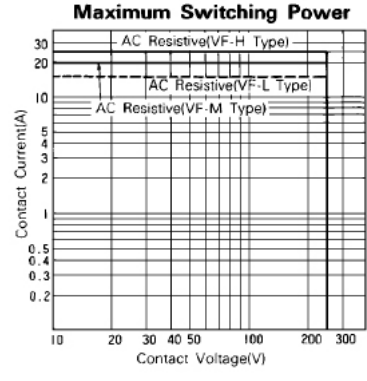
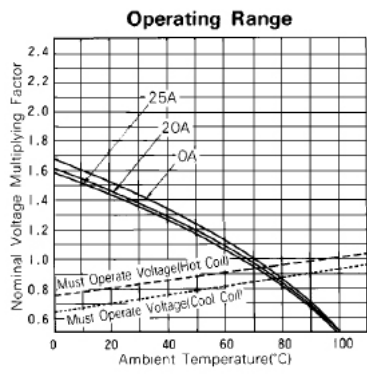
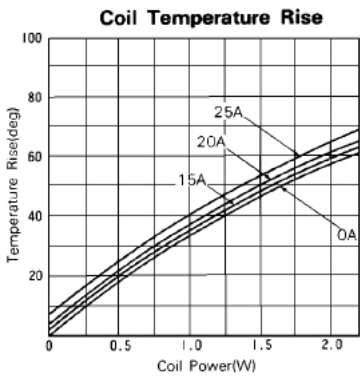

■ DIMENSIONS

VF-type

● Dimensions

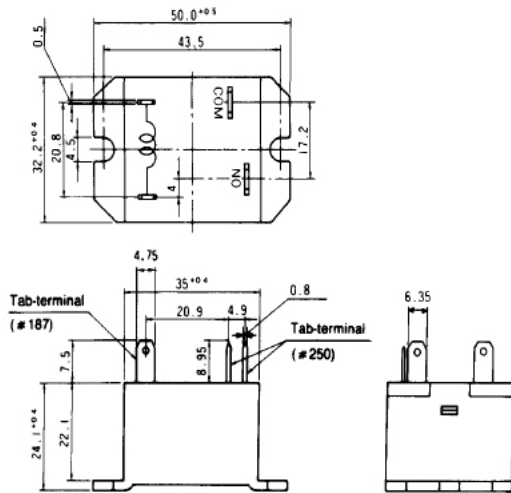

● Schematics (TOP VIEW)

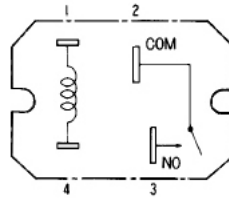

● PC board mounting hole layout (TOP VIEW)

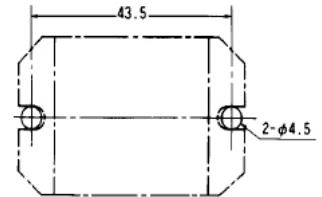

VFB-type

● Dimensions

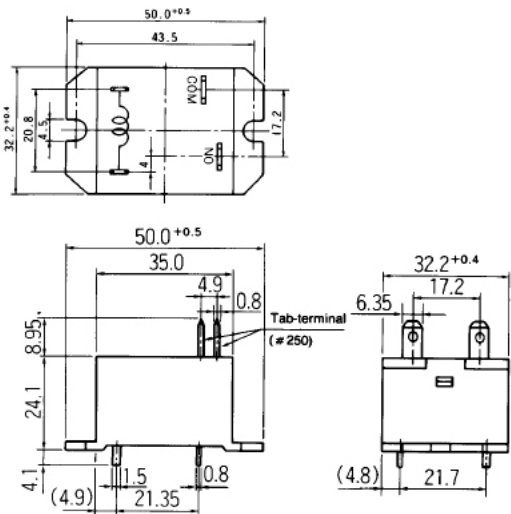

● Schematics

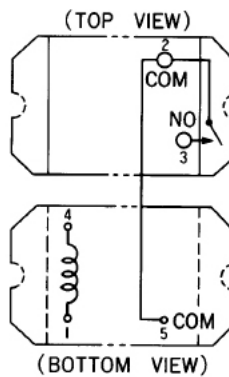

● PC board mounting hole layout

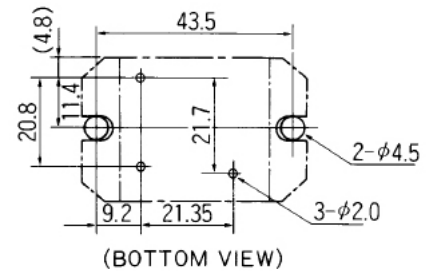

Unit: mm

VFD-type

● Dimensions

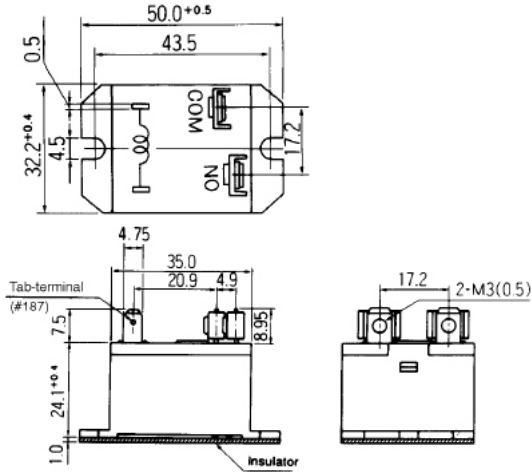

● Schematics (TOP VIEW)

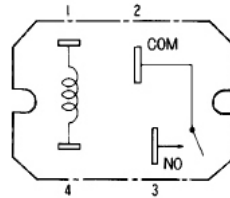

● PC board mounting hole layout (TOP VIEW)

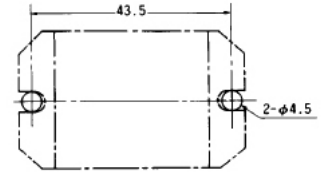

VFP-type

● Dimensions

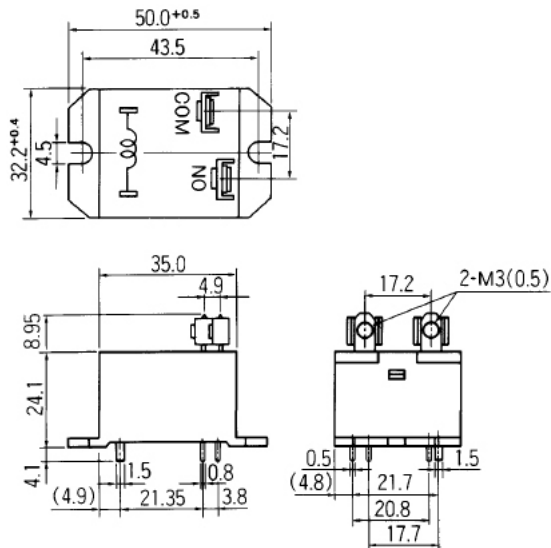

● Schematics

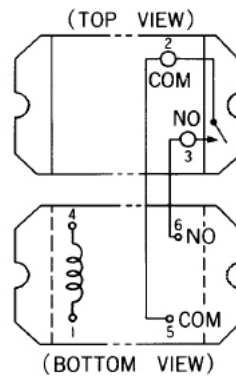

● PC board mounting hole layout

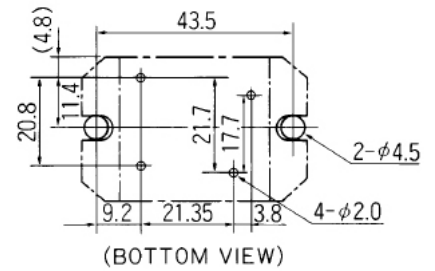

Unit: mm

Note: This datasheet provide only + tolerance for outer dimensions.

RoHS Compliance and Lead Free Information

1. General Information

- All relays produced by Fujitsu Components are compliant with RoHS directive 2011/65/EU including amendments.
- Cadmium as used in electrical contacts is exempted from the RoHS directives. As per Annex III of directive 2011/65/EU.
- All relays are lead-free. Please refer to Lead-Free Status Info for older date codes at: <http://www.fujitsu.com/downloads/MICRO/fcai/relays/lead-free-letter.pdf>
- Lead free solder plating on relay terminals is Sn-3.0Ag-0.5Cu, unless otherwise specified. This material has been verified to be compatible with PbSn assembly process.

2. Recommended Lead Free Solder Condition

- Recommended solder Sn-3.0Ag-0.5Cu.

Flow Solder Condition:

Pre-heating: maximum 120°C
within 90 sec.
Soldering: dip within 5 sec. at
255°C ± 5°C solder bath
Relay must be cooled by air immediately
after soldering

Solder by Soldering Iron:

Soldering Iron 30-60W
Temperature: maximum 350-360°C
Duration: maximum 3 sec.

We highly recommend that you confirm your actual solder conditions

3. Moisture Sensitivity

- Moisture Sensitivity Level standard is not applicable to electromechanical relays, unless otherwise indicated.

4. Tin Whiskers

- Dipped SnAgCu solder is known as presenting a low risk to tin whisker development. No considerable length whisker was found by our in house test.

Fujitsu Components International Headquarter Offices

<p>Japan Fujitsu Component Limited Shinagawa Seaside Park Tower 19F, 12-4, Higashi-shinagawa 4-chome, Shinagawa-ku, Tokyo, 140-0002, Japan Tel: (81-3) 3450-1681 Fax: (81-3) 3474-2385 Email: fcl-contact@cs.jp.fujitsu.com Web: www.fcl.fujitsu.com</p>	<p>Europe Fujitsu Components Europe B.V. Diamantlaan 25 2132 WV Hoofddorp Netherlands Tel: (31-23) 5560910 Fax: (31-23) 5560950 Email: info@fceu.fujitsu.com Web: emea.fujitsu.com/components/</p>
<p>North and South America Fujitsu Components America, Inc. 2290 North 1st Street, Suite 212 San Jose, CA 95131, USA Tel: (1-408) 745-4900 Fax: (1-408) 745-4970 Email: components@us.fujitsu.com Web: http://us.fujitsu.com/components</p>	<p>Asia Pacific Fujitsu Components Asia Ltd. 102E Pasir Panjang Road #01-01 Citilink Warehouse Complex Singapore 118529 Tel: (65) 6375-8560 Fax: (65) 6273-3021 Email: fcal@fcal.fujitsu.com Web: http://www.fujitsu.com/sg/services/micro/components/</p>

©2014 Fujitsu Components Europe B.V. All rights reserved. All trademarks or registered trademarks are the property of their respective owners.

The contents, data and information in this datasheet are provided by Fujitsu Component Ltd. as a service only to its user and only for general information purposes.

The use of the contents, data and information provided in this datasheet is at the users' own risk.

Fujitsu has assembled this datasheet with care and will endeavor to keep the contents, data and information correct, accurate, comprehensive, complete and up to date.

Fujitsu Components Europe B.V. and affiliated companies do however not accept any responsibility or liability on their behalf, nor on behalf of its employees, for any loss or damage, direct, indirect or consequential, with respect to this datasheet, its contents, data, and information and related graphics and the correctness, reliability, accuracy, comprehensiveness, usefulness, availability and completeness thereof.

Nor do Fujitsu Components Europe B.V. and affiliated companies accept on their behalf, nor on behalf of its employees, any responsibility or liability for any representation or warrant of any kind, express or implied, including warranties of any kind for merchantability or fitness for particular use, with respect to these datasheets, its contents, data, information and related graphics and the correctness, reliability, accuracy, comprehensiveness, usefulness, availability and completeness thereof. Rev. August 04, 2014