

SONY

User Guide

Personal Computer
VGN-SZ600 Series



Contents

Before Use	6
Documentation	6
Ergonomic Considerations	9
Getting Started	11
Locating Controls and Ports	12
About the Indicator Lights	18
Connecting a Power Source	20
Using the Battery Pack	21
Shutting Down Your Computer Safely	27
Using Your VAIO Computer	28
Using the Keyboard	29
Using the Touch Pad	31
Using Special-function Buttons	32
Using the Built-in MOTION EYE Camera.....	33
Using the Optical Disc Drive	34
Using PC Cards	43
Using the ExpressCard Module	46
Using the Memory Stick Media	50
Using Other Memory Cards	56
Using the Internet.....	59
Using Wireless LAN (WLAN)	60
Using the Bluetooth Functionality	67

Using Peripheral Devices	74
Connecting a Docking Station	75
Connecting External Speakers	84
Connecting an External Display	85
Selecting Display Modes	89
Using the Multiple Monitors Function	92
Connecting an External Microphone	94
Connecting a Universal Serial Bus (USB) Device	95
Connecting a Printer	98
Connecting an i.LINK Device	99
Connecting to a Network (LAN)	101
Customizing Your VAIO Computer	103
Selecting Performance Modes	104
Setting the Password	105
Using Fingerprint Authentication	116
Using Trusted Platform Module (TPM)	124
Setting Up Your Computer with VAIO Central	131
Using VAIO Status Monitor	132
Using the Power Saving Modes	133
Managing Power with VAIO Power Management	138
Protecting the Hard Disk	141
Upgrading Your VAIO Computer	142
Adding and Removing Memory	143

- Precautions 150
 - On Handling the LCD Screen 151
 - On Using the Power Source 152
 - On Handling Your Computer 153
 - On Using the Built-in MOTION EYE Camera 155
 - On Handling Floppy Disks 156
 - On Handling Discs 157
 - On Using the Battery Pack 158
 - On Using Headphones 159
 - On Handling Memory Stick Media 160
 - On Handling the Hard Disk 161
 - On Handling the Memory Card Adapter 162
 - On Updating Your Computer 163
- Troubleshooting 164
 - Computer 166
 - System Security 173
 - Battery 174
 - Built-in MOTION EYE Camera 176
 - Internet 179
 - Networking 181
 - Bluetooth Technology 184
 - Optical Discs 188
 - Display 192
 - Printing 196

Microphone	197
Mouse	198
Speakers	199
Touch Pad.....	201
Keyboard.....	202
Floppy Disks	203
PC Cards	204
Audio/Video.....	206
Memory Stick Media	207
Peripherals.....	208
Docking Station.....	209
Support Options	210
Sony Support Information	210
Program Support Information.....	213

Before Use

Congratulations on your purchase of this Sony VAIO® computer, and welcome to the on-screen User Guide. Sony has combined leading-edge technology in audio, video, computing, and communications to provide state-of-the-art personal computing.

! External views illustrated in this manual may look slightly different from those of your computer.

Documentation

Your documentation includes printed information and user guides to read on your VAIO computer.

Printed Documentation

- ❑ **Welcome mat** — Contains an overview of component connection, set-up information, etc.
- ❑ **Safety Information** — Contains safety guidelines and owner information.

Non-printed Documentation

- ❑ **User Guide** (this manual) — Explains features of your computer. It also includes information about the software programs included with your computer, as well as information on solving common problems.
- ❑ **Specifications** — The online **Specifications** describe the hardware and software configurations of your VAIO computer.

To view the online **Specifications**:

- 1 Connect to the Internet.
- 2 Go to the Sony online support Web site at the following URLs:
<http://esupport.sony.com/EN/VAIO/> for customers in USA
<http://www.sony.ca/support> for customers in Canada
<http://esupport.sony.com/ES/VAIO/> for customers in Spanish speaking Latin American countries or areas
<http://esupport.sony.com/ES/VAIO/BR/> for customers in Brazil

- ❑ **VAIO Recovery Center User Guide** — Provides information about restoring individual software programs, software drivers, and drive partition(s) or your entire hard disk drive to the original factory installed settings.

To access this on-screen guide:

- 1 Click **Start**  and **Help and Support**.
- 2 Click **Manuals & Specifications**.
- 3 Click **VAIO Recovery Center User Guide**.

- ❑ **SmartWi™ Connection Utility Help** (Selected models only) — Provides information about setting up Bluetooth, wireless LAN, and wireless WAN functionalities.

To access this on-screen guide:

- 1 Click **Start**, **All Programs**, and **SmartWi Connection Utility**.
- 2 Click **SmartWi Connection Utility Help**.

Help and Support

Help and Support is easy to access and provides a single location for information and technical assistance for your VAIO computer. Choose from the following categories to find the answers you need.

To access **Help and Support**, click **Start** and **Help and Support**.

Manuals & Specifications

Here you will find the on-screen **User Guide**, warranty information, other VAIO documents, and system and software information for your computer.

VAIO Support

Access interactive help in the form of VAIO tutorials, an escalation page containing support and contact information, and various links to VAIO online support Web sites.

Backup & Recovery

Find information on how to back up and restore your operating system, system software, and your personal data.

Wireless & Networking

Learn about wireless connections including Bluetooth Wireless technology and Wireless LAN. Run utilities that include **VAIO Media Setup** and **Windows Network and Sharing Center**, and access to wireless tutorials.

Security

Keep your data safe and your computer running efficiently with updates and maintenance programs from Microsoft and Sony.

VAIO Sites

Contains links to other Internet sites you might find interesting and useful.

Ergonomic Considerations

You will be using your computer as a portable device in a variety of environments. Whenever possible, you should attempt to take account of the following ergonomic considerations for both stationary and portable environments:

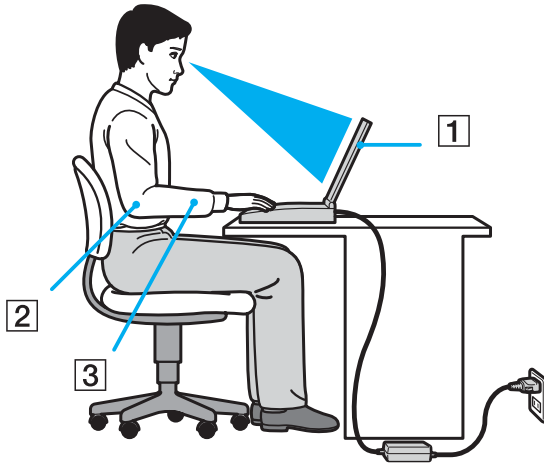

- ❑ **Position of your computer** – Place the computer directly in front of you (1). Keep your forearms horizontal (2), with your wrists in a neutral, comfortable position (3) while using the keyboard, touch pad, or external mouse. Let your upper arms hang naturally at your sides. Have breaks during sessions with your computer. Excessive use of the computer may strain eyes, muscles, or tendons.
- ❑ **Furniture and posture** – Sit in a chair with good back support. Adjust the level of the chair so your feet are flat on the floor. A footrest may make you more comfortable. Sit in a relaxed, upright posture and avoid slouching forward or leaning far backwards.

- ❑ **Viewing angle of the computer's display** – Use the display's tilting feature to find the best position. You can reduce eye strain and muscle fatigue by adjusting the tilt of the display to the proper position. Adjust the brightness level of the display as well.
- ❑ **Lighting** – Choose a location where windows and lights do not cause glare and reflection on the display. Use indirect lighting to avoid bright spots on the display. Proper lighting adds to your comfort and work efficiency.
- ❑ **Positioning an external display** – When using an external display, set the display at a comfortable viewing distance. Make sure the display screen is at eye level or slightly lower when you are sitting in front of the monitor.

Getting Started

This section describes how to get started using your VAIO computer.

! Before starting your computer for the first time, do not connect any other hardware that did not originally come with your computer. Be sure to start up your computer with only the supplied accessories connected and set up your system. Upon completion, connect one device (for example, a printer, an external hard disk drive, a scanner, and so on) at a time, following the manufacturers' instructions.

- ❑ **Locating Controls and Ports** ([page 12](#))
- ❑ **About the Indicator Lights** ([page 18](#))
- ❑ **Connecting a Power Source** ([page 20](#))
- ❑ **Using the Battery Pack** ([page 21](#))
- ❑ **Shutting Down Your Computer Safely** ([page 27](#))

Locating Controls and Ports

Take a moment to identify the controls and ports shown on the following pages.

! Please note that the illustrations in this manual may not necessarily apply to your model.

Front

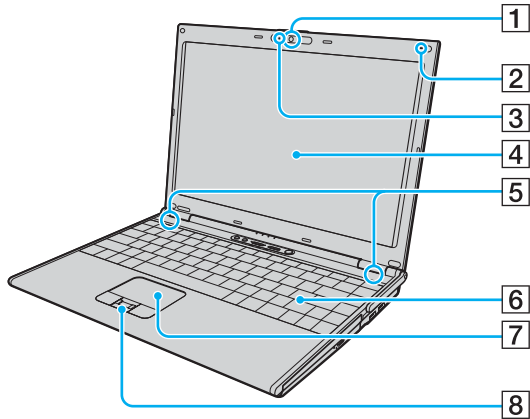

- 1 Built-in **MOTION EYE** camera* ([page 33](#))
- 2 Built-in microphone (monaural)*
- 3 Built-in **MOTION EYE** camera indicator* ([page 18](#))
- 4 LCD screen ([page 151](#))
- 5 Built-in speakers (stereo)
- 6 Keyboard ([page 29](#))
- 7 Touch pad ([page 31](#))
- 8 Fingerprint sensor ([page 116](#))

* On selected models only.

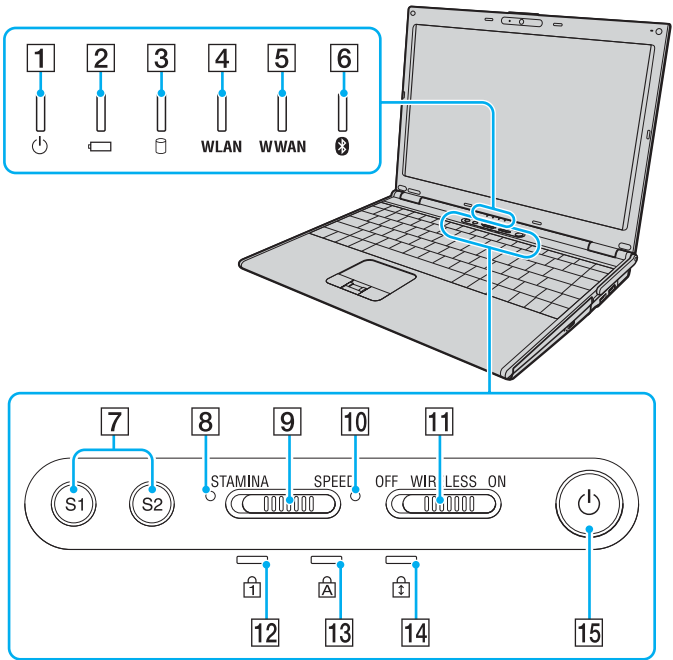

- 1 Power indicator (page 18)
- 2 Battery indicator (page 18)
- 3 Hard disk drive indicator (page 18)
- 4 **WLAN** (Wireless LAN) indicator (page 18)
- 5 **WWAN** (Wireless WAN) indicator* (page 18)
- 6 Bluetooth indicator (page 18)
- 7 **S1/S2** buttons (page 32)
- 8 **STAMINA** mode indicator (page 18)
- 9 Performance selector switch (page 104)
- 10 **SPEED** mode indicator (page 18)
- 11 **WIRELESS** switch (page 60)
- 12 Num lock indicator (page 18)
- 13 Caps lock indicator (page 18)
- 14 Scroll lock indicator (page 18)
- 15 Power button

* On selected models only.

Back

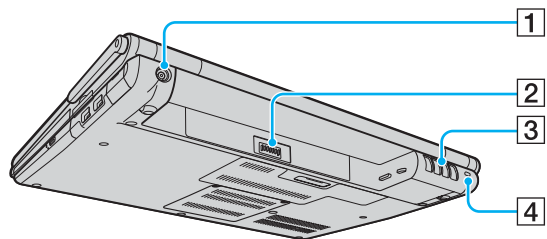

- 1 DC IN port ([page 20](#))
- 2 Battery connector ([page 21](#))
- 3 Air vents
- 4 Security slot

Right

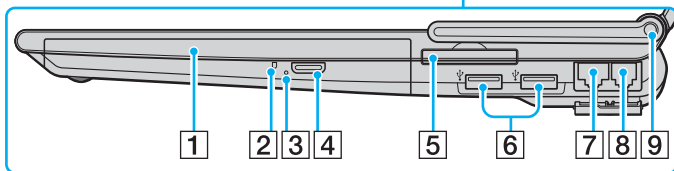
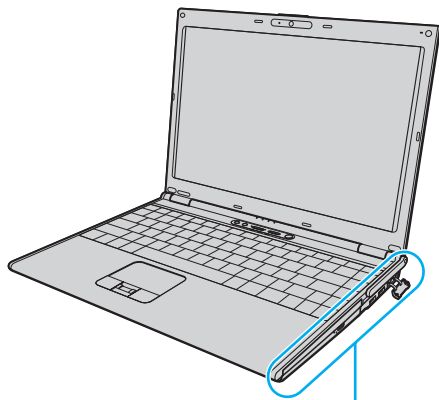

- 1 Optical disc drive ([page 34](#))
- 2 Optical disc drive indicator ([page 18](#))
- 3 Manual eject hole ([page 188](#))
- 4 Drive eject button ([page 34](#))
- 5 ExpressCard/34 slot ([page 46](#))
- 6 Hi-Speed USB (USB 2.0) ports*¹ ([page 95](#))
- 7 Network (Ethernet) port ([page 101](#))
- 8 Modem port ([page 59](#))
- 9 WWAN antenna*² ([page 60](#))

*¹ Support high-/full-/low- speeds.

*² On selected models only.

Left

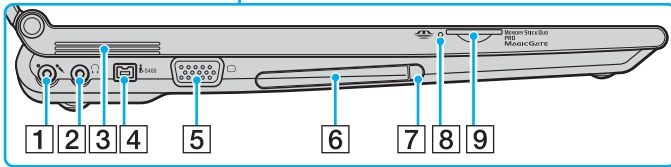
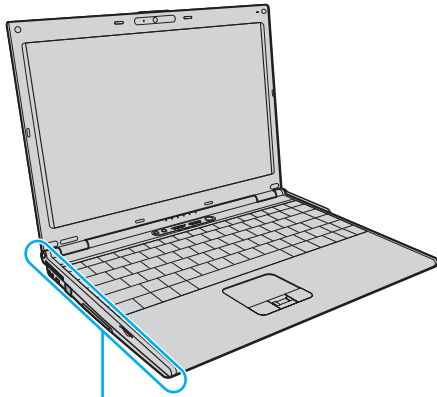

- 1 Microphone jack (page 94)
 - 2 Headphones jack (page 84)
 - 3 Air vents
 - 4 i.LINK (IEEE 1394) S400 port (page 99)
 - 5 Monitor (VGA) port (page 86)
 - 6 PC Card slot (page 43)
 - 7 PC Card release button (page 45)
 - 8 Memory Stick Duo/PRO Duo media indicator (page 18)
 - 9 Memory Stick Duo/PRO Duo media slot* (page 51)
- * Your computer supports Memory Stick Duo media and Memory Stick PRO Duo media with high speed and high capacity capabilities.



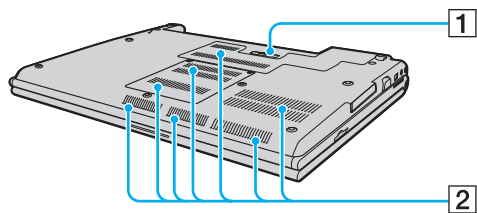



Bottom



- 1 Docking station connector ([page 76](#))
- 2 Air vents

About the Indicator Lights

Your computer is equipped with the following indicator lights.

Indicator	Functions
Power 	Illuminates when the power of the computer is on, blinks when the computer is in Sleep mode, and turns off when the computer is in Hibernate mode or off.
Battery 	Illuminates when the computer is using battery power, blinks when the battery pack is running out of power, and double-blinks when the battery pack is charging.
Memory Stick Duo/PRO Duo media 	Illuminates when data is read from or written to the Memory Stick media in the Memory Stick Duo/PRO Duo media slot. (Do not enter Sleep mode or turn off the computer when this indicator is on.) When the indicator is off, the Memory Stick media is not being used.
Built-in MOTION EYE camera *	Illuminates while the built-in MOTION EYE camera is in use.
Optical disc drive	Illuminates when data is read from or written to the optical disc media. When the indicator is off, the optical disc media is not being used.
STAMINA mode	Illuminates when the computer is in STAMINA mode to conserve battery power.
SPEED mode	Illuminates when the computer is in SPEED mode to provide faster performance.
Hard disk drive 	Illuminates when data is read from or written to the hard disk drive. Do not enter Sleep mode or turn off the computer when this indicator is on.
Num lock 	Press the Num Lk key to activate the numeric keypad. Press it a second time to deactivate the numeric keypad. The numeric keypad is not active when the indicator is off.
Caps lock 	Press the Caps Lock key to type letters in uppercase. Letters appear in lowercase if you press the Shift key while the indicator is on. Press the key a second time to turn off the indicator. Normal typing resumes when the Caps lock indicator is off.

Connecting a Power Source

You can use either an AC adapter or a rechargeable battery pack as a power source for your computer.

Using the AC Adapter



Use your computer only with the supplied AC adapter.

To use the AC adapter

- 1 Plug one end of the power cord (1) into the AC adapter (3).
- 2 Plug the other end of the power cord into an AC outlet (2).
- 3 Plug the cable attached to the AC adapter (3) into the **DC IN** port (4) on the computer or on the optional docking station.

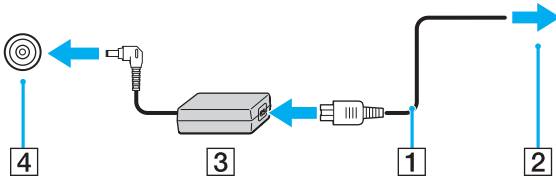

! The shape of the DC In plug varies depending on the AC adapter.



To disconnect your computer completely from AC power, unplug the AC adapter.

Make sure that the AC outlet is easily accessible.

If you do not intend to use your computer for a long period of time, place the computer into Hibernate mode. See **Using Hibernate Mode (page 136)**. This power saving mode saves the time of shutting down or resuming.

Using the Battery Pack

The battery pack supplied with your computer is not fully charged at the time of delivery.

Installing the Battery Pack

To install the battery pack

- 1 Turn off the computer and close the LCD screen lid.
- 2 Slide the battery lock switch (1) inward.

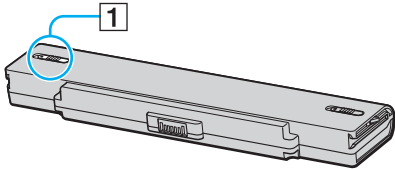

- 3 Slide the battery pack into the battery compartment until it clicks into place.

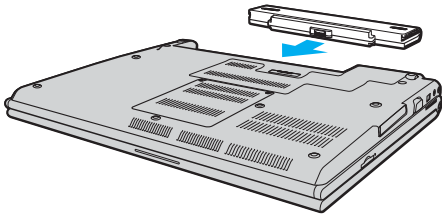

- 4 Slide the battery lock switch (1) to the **LOCK** position to secure the battery pack on the computer.



When your computer is directly connected to AC power and has a battery pack installed, it uses power from the AC outlet.



This computer is designed to operate only with genuine Sony batteries.

Charging the Battery Pack

The battery pack supplied with your computer is not fully charged at the time of delivery.

To charge the battery pack

- 1 Install the battery pack.
- 2 Connect the AC adapter to the computer.

The computer automatically charges the battery pack (the battery indicator light flashes in a double blink pattern as the battery pack charges). When the battery pack charges close to the maximum charge level you selected with the battery care function, the battery indicator turns off. To select your desired maximum charge level with the battery care function, see **To use the battery care function (page 25)**.

Battery indicator light status	Meaning
On	The computer is using battery power.
Blinks	The battery pack is running out of power.
Double blinks	The battery pack is charging.
Off	The computer is using AC power.

! Charge the battery pack as described in this manual from your first battery charge.



When the battery pack is running out of power, both the battery and power indicator lights blink.

Keep the battery pack in your computer while it is directly connected to AC power. The battery pack continues to charge while you are using the computer.

If the battery level falls below 10%, you should either connect the AC adapter to recharge the battery pack or shut down your computer and install a fully charged battery pack.

The battery pack supplied with your computer is a lithium ion battery pack and can be recharged any time. Charging a partially discharged battery pack does not affect its battery life.

The battery indicator light is on while you use the battery pack as a power source. When battery life is nearly depleted, both the battery and power indicator lights start flashing.

For some software applications and some peripheral devices, your computer may not enter Hibernate mode even when battery life is low. To avoid loss of data when using battery power, you should save your data frequently and manually activate a power management mode, such as Sleep or Hibernate.

If the battery pack wears out when the computer enters Sleep mode, you will lose any unsaved data. Going back to the previous work state is impossible. To avoid loss of data, you should save your data frequently.

When your computer is directly connected to AC power and has a battery pack installed, it uses power from the AC outlet.

To use the battery care function

You can select your desired maximum charge level with the battery care function to reduce battery degradation.

- 1 Click **Start, All Programs**, and **VAIO Central**.
The **VAIO Central** window appears.
- 2 Double-click **Power Management** and **Battery Care Function**.
- 3 Click to select the **Enable Battery Care Function** check box.
- 4 Select the desired maximum charge level.
- 5 Click **OK**.

Removing the Battery Pack

! You may lose data if you remove the battery pack while your computer is on and not connected to the AC adapter or if you remove the battery pack while the computer is in Sleep mode.

To remove the battery pack

- 1 Turn off the computer and close the LCD screen lid.
- 2 Slide the battery lock switch (1) inward.

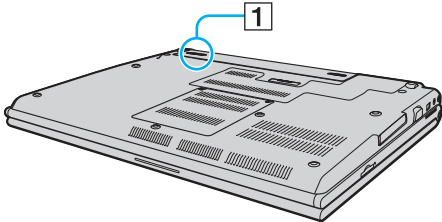

- 3 Slide and hold the battery release latch (2) and slide the battery pack away from the computer.

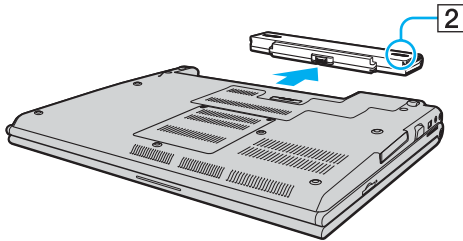

Shutting Down Your Computer Safely

To avoid losing unsaved data, be sure to shut down your computer properly, as described below.

To shut down your computer

- 1 Turn off any peripherals connected to the computer.
- 2 Click **Start**, the arrow  next to the **Lock** button, and **Shut Down**.
- 3 Respond to any prompts warning you to save documents or to consider other users and wait for the computer to turn off automatically.
The power indicator light turns off.

Using Your VAIO Computer

This section describes how to get the most out of using your VAIO computer.

- ❑ **Using the Keyboard** ([page 29](#))
- ❑ **Using the Touch Pad** ([page 31](#))
- ❑ **Using Special-function Buttons** ([page 32](#))
- ❑ **Using the Built-in MOTION EYE Camera** ([page 33](#))
- ❑ **Using the Optical Disc Drive** ([page 34](#))
- ❑ **Using PC Cards** ([page 43](#))
- ❑ **Using the ExpressCard Module** ([page 46](#))
- ❑ **Using the Memory Stick Media** ([page 50](#))
- ❑ **Using Other Memory Cards** ([page 56](#))
- ❑ **Using the Internet** ([page 59](#))
- ❑ **Using Wireless LAN (WLAN)** ([page 60](#))
- ❑ **Using the Bluetooth Functionality** ([page 67](#))





Using the Keyboard



Your keyboard is very similar to a desktop computer keyboard, but has additional keys that perform model-specific tasks.

Combinations and Functions with the Fn Key



Some keyboard functions can be used only after the operating system finished launching.

Combinations/Feature	Functions
Fn + F1 : wireless switching*	Toggles among Bluetooth, wireless LAN, and wireless WAN functionalities.
Fn +  (F2) : speaker switch	Turns on and off the built-in speakers and the headphones.
Fn +  (F3/F4) : volume	Adjusts the volume level. To increase the volume, press Fn+F4 and then ↑ or → , or keep pressing Fn+F4 . To decrease the volume, press Fn+F3 and then ↓ or ← , or keep pressing Fn+F3 .
Fn +  (F5/F6) : brightness control	Adjusts the LCD brightness of your computer screen. To increase lighting intensity, press Fn+F6 and then ↑ or → , or keep pressing Fn+F6 . To decrease lighting intensity, press Fn+F5 and then ↓ or ← , or keep pressing Fn+F5 .
Fn +  /  (F7) : display output	Toggles among your computer screen, an external display, and simultaneous output to both.

Combinations/Feature	Functions
Fn +  (F10): zoom	<p>Changes the screen resolution to magnify/restore your computer's screen view.</p> <p> The magnified view is not as clear as the standard view, as it is implemented by applying a lower resolution to the computer screen with a higher resolution. This key combination may not work with graphic images as it magnifies the screen view by changing the resolution. The location and size of software windows may change when the screen view is magnified or the standard view is restored because pressing this key combination changes the resolution. When your computer's screen view is magnified, switching the view to the external display disables the function and restores the standard view.</p>
Fn +  (F12): Hibernate	<p>Provides for the lowest level of power consumption. When you execute this command, the states of the system and the connected peripheral devices are written to the hard disk drive and the system power is turned off. To return the system to its original state, use the power button to turn on the power.</p> <p>For details on power management, see Using the Power Saving Modes (page 133).</p>

* On selected models only.

Using the Touch Pad

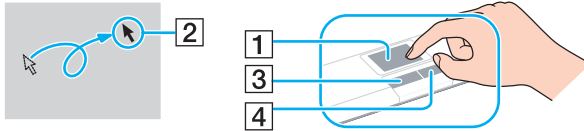

You can point to, select, drag, and scroll objects on the screen using the touch pad.



Action	Description
Point	Slide your finger on the touch pad (1) to place the pointer (2) on an item or object.
Click	Press the left button (3) once.
Double-click	Press the left button twice.
Right-click	Press the right button (4) once. In many applications, this action displays a shortcut menu.
Drag	Slide your finger on the touch pad while pressing the left button.
Scroll	Slide your finger along the right edge of the touch pad to scroll vertically. Slide your finger along the bottom edge to scroll horizontally (the scroll function is available only with applications that support a touch pad scroll feature).  You can also use the fingerprint sensor for vertical scrolling while the Scroll lock indicator is lit. Press the Fn+Scr Lk keys to turn on and off the indicator.

Using Special-function Buttons

Your computer is equipped with special buttons to help you use specific functions of the computer.

Special-function button	Functions
S1/S2 buttons  	By default, the S1 button turns the volume on and off and the S2 button toggles among your computer screen, an external display, and simultaneous output to both. You can change these button assignments in the window for changing the S button assignments. To display this window, press and hold either button or launch and navigate through VAIO Central .

Using the Built-in MOTION EYE Camera

Your computer may be equipped with a built-in **MOTION EYE** camera. See the online **Specifications** to find whether your model is equipped with the built-in **MOTION EYE** camera.

The built-in **MOTION EYE** camera adds video functionality to instant messaging software and video editing software.

Turning on the computer activates the built-in **MOTION EYE** camera, so the computer is ready for a video conference using such software.

Note that launching or exiting your instant messaging or video editing software does not activate or deactivate the built-in **MOTION EYE** camera, respectively. Make sure that the camera is activated before using the software.



The built-in **MOTION EYE** camera cannot be shared by more than one software application. If another software application is using the camera, exit the application before using the built-in **MOTION EYE** camera.

When capturing an image in a dark place, click the **VAIO Camera Utility** icon on the taskbar and the **Advanced Settings** button and select the **Low Light** check box on the **Properties** window. It decreases the frame rate and slows down the shutter speed to allow the camera to capture more light.



The viewer window may show some noises, for example horizontal streaks, if you view a rapid-moving object. This is normal and does not indicate a malfunction.

You cannot operate the built-in **MOTION EYE** camera with the **Microsoft Windows MovieMaker** software.

Using the Optical Disc Drive

Your computer is equipped with an optical disc drive.

To insert a disc

- 1 Turn on the computer.
- 2 Press the drive eject button (1) to open the drive.
The tray slides out.
- 3 Place a disc in the middle of the tray with the label side facing upward and gently push it until the disc clicks into place.

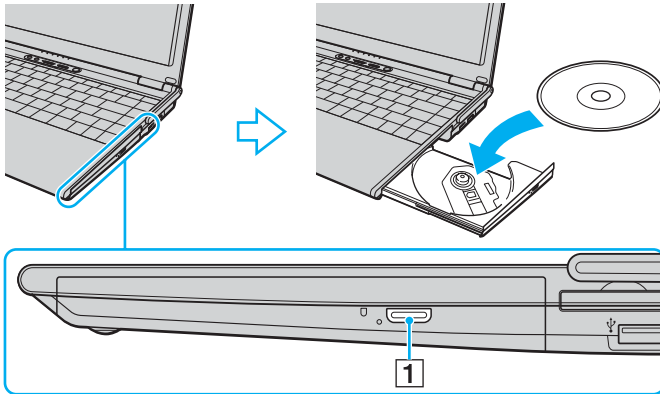

4 Close the tray by pushing it in gently.

! Do not remove the optical disc when your computer is in a power saving mode (Sleep or Hibernate). Doing so may cause the computer to malfunction.



If you plan to use an external optical disc drive, connect the drive before you launch any preinstalled disc operation program.

Reading and Writing Optical Discs

Your computer plays and records CDs, DVDs, or Blu-ray Discs™, depending on the model you purchased. Check your specifications for the type of optical disc drive installed on your model. Use the table below to see which types of media your optical disc drive supports.

PR: playable and recordable
 P: playable but not recordable
 -: not playable or recordable

	CD-ROM	Video CD	Music CD	CD Extra	CD-R/RW	DVD-ROM	DVD-Video	BD-ROM	DVD-R/RW	DVD+R/RW	DVD+R DL	DVD-R DL	DVD-RAM	BD-R ^{*9} /RE ^{*10}
DVD±RW/±R DL/RAM	P	P	P	P	PR	P	P	-	PR ^{*1 *2}	PR	PR ^{*5}	PR ^{*6}	PR ^{*3 *4}	-
CD-RW/DVD-ROM	P	P	P	P	PR	P	P	-	P	P	P	P	-	-
DVD-ROM	P	P	P	P	P	P	P	-	P	P	P	P	-	-
Blu-ray Disc	P	P	P	P	PR ^{*8}	P	P	P	PR ^{*1 *2}	PR	PR ^{*5}	PR ^{*6}	PR ^{*3 *4}	PR ^{*7}

^{*1} Supports writing data to DVD-R discs compliant with DVD-R for General Version 2.0/2.1.

^{*2} Supports writing data to DVD-RW discs compliant with DVD-RW Version 1.1/1.2.

^{*3} The DVD±RW/RAM disc drive on your computer does not support the DVD-RAM cartridge. Use non-cartridge discs or discs with removable cartridge.

^{*4} Writing data to single-sided DVD-RAM discs (2.6 GB) compliant with DVD-RAM Version 1.0 is not supported. DVD-RAM Version 2.2/12X-SPEED DVD-RAM Revision 5.0 disc is not supported.

^{*5} Writing data to DVD+R DL (Double Layer) discs is available only on discs supporting DVD+R DL (Double Layer) recording.

^{*6} Writing data to DVD-R DL (Dual Layer) discs is available only on discs supporting DVD-R DL (Dual Layer) recording.

^{*7} Supports writing data to BD-R Version 1.1 discs (single-layer discs with the capacity of 25 GB, dual-layer discs with the capacity of 50 GB) and BD-RE Version 2.1 discs (single-layer discs with the capacity of 25 GB, dual-layer discs with the capacity of 50 GB). The Blu-ray Disc drive on your computer does not support BD-RE Version 1.0 discs and Blu-ray cartridge discs.

^{*8} Writing data to Ultra Speed CD-RW discs is not supported on models with the Blu-ray Disc drive.

^{*9} BD-R stands for Blu-ray Disc-Recordable in Version 1.1 format.

^{*10} BD-RE stands for Blu-ray Disc-Rewritable in Version 2.1 format.

! This product is designed to playback discs that conform to the Compact Disc Digital Audio standard specifications (CD Standard). A DualDisc is a two sided disc product which mates DVD recorded material on one side with digital audio material on the other side. Be aware that the audio side (non-DVD side) of a DualDisc may not play on this product because it does not conform to the CD Standard.

Due to the multiple formats of discs now available, when buying pre-recorded or blank discs for use with a VAIO computer, be sure to read the notices on the disc packaging carefully to check both playback and recording compatibility with your computer's optical disc drives. Sony does NOT guarantee the compatibility of VAIO CD drives with discs that are not compliant with the official "CD" format standard (or "DVD" standard in relation to DVD drives, or "Blu-ray Disc" standard in relation to Blu-ray Disc drives). USING NON-COMPLIANT DISCS CAN CAUSE FATAL DAMAGE TO YOUR VAIO PC OR CREATE SOFTWARE CONFLICTS AND CAUSE SYSTEM HANGING.

For inquiries about disc formats, contact the individual publisher of the pre-recorded disc or the manufacturer of the recordable disc.



8cm disc writing is not supported.

! To play copyright protected Blu-ray Discs continuously, you need to update the AACS key. Note that the AACS key update requires Internet access.

As with other optical media devices, circumstances may limit compatibility or prevent Blu-ray Disc playback. VAIO computers may not support movie playback on packaged media recorded in AVC or VC1 formats at high bit rates.

Region settings are required for movies and BD-ROM contents. If the region setting on the optical disc drive does not match the region coding on the disc, playback is not possible.

Unless your external display is compliant with the High-bandwidth Digital Content Protection (HDCP) standard, you cannot play or view the contents of copyright protected Blu-ray Discs.

Some contents may restrict video output to be standard definition or prohibit analog video output at all. It is strongly recommended that digital HDCP-compliant environment be implemented for optimum compatibility and viewing quality.

Notes on writing data to a disc

- ❑ Use only Sony recommended software, which is preinstalled on your computer, to write data to a disc. Other software programs may not be fully compatible and errors may result.
- ❑ To make data on a disc readable on the optical disc drive, you need to close the session before you eject it. To complete this process, follow the instructions included with your software.
- ❑ Only use circular discs. Do not use discs in any other shape (star, heart, card, etc.), as this may damage the optical disc drive.
- ❑ Do not strike or shake your computer while writing data to a disc.
- ❑ Deactivate the screen saver and exit anti-virus software before writing data to a disc.
- ❑ Do not use memory-resident utility software while writing data to a disc. This may cause your computer to malfunction.
- ❑ Before using your software application to burn discs, make sure you exit and close all other applications.
- ❑ Do not switch to power saving modes while using the preinstalled software or any disc burning software.
- ❑ Connect and use the AC adapter to power your computer or make sure your battery pack is at least 50% charged.
- ❑ Make sure you use the same disc burning software to add data to a used disc. Use of different disc burning software for additional data burning may cause a failure. For example, if you have a disc with data that you burned with the **Roxio Easy Media Creator** software, use the **Roxio Easy Media Creator** software to add more data to the same disc.

Notes on playing discs

To achieve optimum performance when playing discs, you should follow these recommendations.

- ❑ Some CD players and computers' optical disc drives may not be able to play audio CDs created with the CD-R or CD-RW disc media.
- ❑ Some DVD players and computers' optical disc drives may not be able to play DVDs created with the DVD+R DL, DVD-R DL, DVD+R, DVD+RW, DVD-R, DVD-RW, or DVD-RAM disc media.
- ❑ Do not use memory-resident utility software to speed up disc access when playing a disc. This may cause your computer to malfunction.
- ❑ Do not switch to power saving modes while your computer is playing a disc.
- ❑ Region code indicators are labeled on the DVDs to indicate in which region and on what type of player you can play the disc. If the DVD is labeled "all," this means that you can play this DVD in most regions of the world. If the region code for your residence area is different from the label on the DVD disc or on the packaging, you cannot play the disc on your computer.

Playing CDs

To play an audio CD

- 1 Insert a disc into the optical disc drive.
- 2 If nothing appears on the desktop, then click **Start, All Programs**, and the desired CD software to play the CD.
If the **Audio CD** window appears, click to select an option.

Copying Files to CDs

To copy files to a disc

! Do not strike or shake your computer while writing data to a disc.

- 1 Insert a disc into the optical disc drive.
If the **AutoPlay** window appears, click **Burn files to disc** and follow the on-screen instructions until the empty disc folder appears.
- 2 Open the folder that contains the file(s) you want to copy and drag them to the empty disc folder.
- 3 Close the disc folder.

Playing DVDs

To play a DVD

- 1 Close all running software applications.
- 2 Insert a DVD into the optical disc drive.
- 3 If nothing appears on the desktop, then click **Start, All Programs**, and the desired DVD software to play the DVD.

For instructions on how to use the software, see the help file on your DVD software.

Copying Files to DVDs

To copy files to a disc

- 1 Connect the AC adapter to the computer.
- 2 Insert a disc into the optical disc drive.
- 3 If nothing appears on the desktop, then click **Start, All Programs**, and the desired DVD software to copy files to the disc.

For instructions on how to use the software, see the help file on your DVD software.

Using PC Cards

PC Cards allow you to connect portable external devices to your computer.

Inserting a PC Card

! Some PC Cards or their functions may not be compatible with your computer.

You do not need to shut down your computer before inserting or removing a PC Card.

To insert a PC Card

- 1 Push the PC Card release button so that the release button pops out.
- 2 Push the PC Card release button a second time so that the PC Card slot protector pops out.
- 3 Gently take hold of the protector and pull it out of the slot.
- 4 Insert the PC Card into the PC Card slot with the front label facing upward.
- 5 Gently push the PC Card into the slot all the way to the end.
The PC Card is automatically detected by your system.
The **Safely Remove Hardware** icon appears on the taskbar.

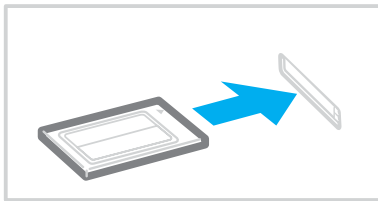

! Insert the PC Card slot protector to protect against debris entering the slot when not using a PC Card. Before moving your computer, make sure to insert the PC Card slot protector into the slot.

 Some devices may not function properly if you continuously switch to Normal mode from Sleep or Hibernate mode. For some PC Cards, if you alternate between Normal mode and Sleep or Hibernate mode while the card is inserted, you may find that the device connected to your system through the PC card is not recognized. Restart your system to correct the problem.

While the card is inserted, your computer may not enter Hibernate mode but Sleep mode. We recommend that you remove the card before the computer enters Hibernate mode.

Make sure you use the latest software driver provided by the PC Card manufacturer.

Do not force a PC Card into the slot. It may damage the connector pins. If you have difficulty inserting a PC Card, check that you are inserting the PC Card in the correct direction. See the manual that came with your PC Card for more information.

Removing a PC Card

Follow the steps below to remove the PC Card while your computer is on. If it is not removed properly, your system may not work properly.

To remove a PC Card



To remove a PC Card when your computer is off, skip steps 1 to 7.

- 1 Double-click the **Safely Remove Hardware** icon on the taskbar.
The **Safely Remove Hardware** window appears.
- 2 Select the hardware you want to unplug.
- 3 Click **Stop**.
The **Stop a Hardware device** window appears.
- 4 Confirm that the device can be safely removed from the system.
- 5 Click **OK**.
A message appears stating it is now safe to remove the hardware device.
- 6 Click **OK**.
- 7 Click **Close** to close the **Safely Remove Hardware** window.
- 8 Push the PC Card release button so that the release button pops out.
- 9 Push the PC Card release button a second time so that the PC Card pops out.
- 10 Gently take hold of the Card and pull it out of the slot.
- 11 If the PC Card release button is still out, push it back in all the way to the end.

Using the ExpressCard Module

Your computer is equipped with either a Universal ExpressCard™ slot* or an ExpressCard™/34 slot* for transferring data among digital cameras, camcorders, music players, and other audio/video devices. The former can accommodate either an ExpressCard™/34 (34 mm wide) or ExpressCard™/54 (54 mm wide) module* as shown below; and the latter, an ExpressCard™/34 module* only.

- ❑ ExpressCard™/34 module*



- ❑ ExpressCard™/54 module*



Your computer is equipped with an ExpressCard™/34 slot*.

* Referred to as the ExpressCard slot and the ExpressCard module in this manual.

Inserting an ExpressCard Module

! Your computer is delivered with a slot protector in the ExpressCard slot. Remove the slot protector before you use the slot.

Use care when inserting or removing the ExpressCard module from the slot. Do not force it in or out of the slot.



You do not need to shut down your computer before inserting or removing the ExpressCard module.

To insert an ExpressCard module

- 1 Push the ExpressCard slot protector to pop it out.
- 2 Gently take hold of the ExpressCard slot protector and pull it out of the slot.
- 3 Hold the ExpressCard module with the arrow facing upward and pointing toward the ExpressCard slot.
- 4 Carefully slide the ExpressCard module (1) into the slot until it clicks into place.
Do not force it into the slot.

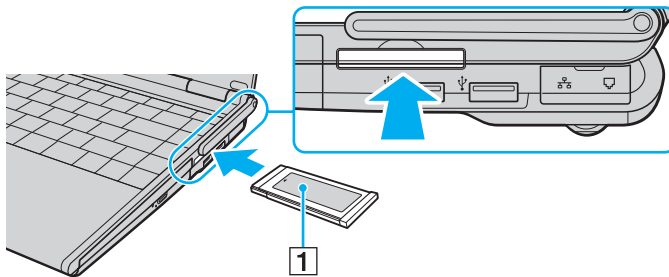

! Insert the ExpressCard slot protector to protect against debris entering the slot when not using an ExpressCard module. Before moving your computer, be sure to insert the ExpressCard slot protector into the slot.



If the module or adapter does not go into the slot easily, remove it gently and verify you are inserting it in the proper direction.

Make sure you use the most recent software driver provided by the ExpressCard module manufacturer.

Removing an ExpressCard Module

Follow the steps below to remove the ExpressCard module while your computer is on. If it is not removed properly, your system may not work properly.

To remove an ExpressCard module



To remove an ExpressCard module when your computer is off, skip steps 1 to 7.

- 1 Double-click the **Safely Remove Hardware** icon on the taskbar.
The **Safely Remove Hardware** window appears.
- 2 Select the hardware you want to unplug.
- 3 Click **Stop**.
The **Stop a Hardware device** window appears.
- 4 Confirm that the device can be safely removed from the system.
- 5 Click **OK**.
A message appears stating it is now safe to remove the device.
- 6 Click **OK**.
- 7 Click **Close** to close the **Safely Remove Hardware** window.
- 8 Push in the ExpressCard module toward the computer to pop it out.
- 9 Gently take hold of the ExpressCard module and pull it out of the slot.

Using the Memory Stick Media

Your computer supports the Memory Stick media. Memory Stick media is a compact, portable, and versatile IC recording media especially designed for exchanging and sharing digital data with compatible products, such as digital cameras, mobile phones and other devices. Because it is removable, it can be used for external data storage.

For the latest information about the Memory Stick media, visit the Memory Stick Web site at <http://www.memorystick.com/en/>.



Your computer has been tested and found compatible with the Sony branded Memory Stick media with capacity of up to 8 GB that are available as of January 2007. However, not all Memory Stick media that meet the same conditions as the compatible media are guaranteed of compatibility.

Inserting a Memory Stick media with multiple conversion adapters is not guaranteed of compatibility.

MagicGate is the general name of the copyright protection technology developed by Sony. Use a Memory Stick media with the MagicGate logo to use this feature.

Inserting a Memory Stick Media

There are two ways you can insert a Memory Stick media into your computer.

- ❑ Using the Memory Stick Duo/PRO Duo media slot
The Memory Stick media slot accommodates a small-size Memory Stick media: Memory Stick Duo or Memory Stick PRO Duo media.
- ❑ Using the ExpressCard slot
To insert a standard-size Memory Stick media, use the ExpressCard slot. To do this, you need the supplied memory card adapter. See **Using the ExpressCard Module (page 46)** and **Using Other Memory Cards (page 56)** for more information.

To insert a Memory Stick media using the Memory Stick Duo/PRO Duo media slot

- 1 Hold the Memory Stick media with the arrow facing upward and pointing toward the Memory Stick Duo/PRO Duo media slot.
- 2 Carefully slide the Memory Stick media into the slot until it clicks into place.
The Memory Stick media is automatically detected by your system and the content of the Memory Stick media is displayed. If nothing appears on the desktop, click **Start, Computer**, and double-click the Memory Stick media icon.

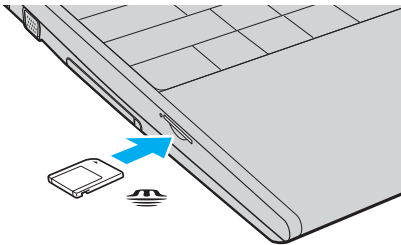

! Be sure to hold the Memory Stick media with the arrow pointing in the correct direction as you insert it into the slot. To avoid damaging your computer or the Memory Stick media, do not force the Memory Stick media into the slot if you cannot insert it smoothly.

Do not insert more than one Memory Stick media into the slot. Improper insertion of the media may damage both your computer and the media.



Your computer supports Memory Stick Duo media and is equipped with the Memory Stick Duo/PRO Duo media slot that is only compatible with the duo-size media. For more information on the Memory Stick Duo media, visit the Memory Stick Web site at <http://www.memorystick.com/en/>.

To view the contents of the Memory Stick media

- 1 Click **Start** and **Computer** to open the **Computer** window.
- 2 Double-click the Memory Stick media icon to view the list of data files saved in the Memory Stick media.

To format a Memory Stick media

The Memory Stick media has been formatted in the factory default setting and is ready for use. If you want to reformat the media with your computer, follow these steps.

! Be sure to use the device that is designed to format the media and supports the Memory Stick media when formatting the media.

Formatting the Memory Stick media erases the entire data on the media. Before formatting the media, make sure that it does not contain your valuable data.

Do not remove the Memory Stick media from the slot while formatting the media. This could cause a malfunction.

- 1 Carefully slide the Memory Stick media into the slot until it clicks into place.
- 2 Click **Start** and **Computer** to open the **Computer** window.
- 3 Right-click the Memory Stick media icon and select **Format**.
- 4 Click **Restore device defaults**.

! The size of the allocation unit and file system may change.

Do not select **NTFS** from the **File system** drop-down list as it may cause a malfunction.



The formatting process will be completed more quickly if you select **Quick Format** in **Format options**.

- 5 Click **Start**.

- 6 At the confirmation prompt, click **OK**.
The formatting process starts.

!

It may take time to format the Memory Stick media depending on the media.

- 7 Once completed, click **OK**.
- 8 Click **Close**.

Removing a Memory Stick Media

To remove a Memory Stick media from the Memory Stick Duo/PRO Duo media slot

- 1 Check that the Memory Stick Duo/PRO Duo media indicator is off.
- 2 Push the Memory Stick media in toward the computer.
The Memory Stick media ejects.
- 3 Pull the Memory Stick media out of the slot.

! Always remove the Memory Stick media gently, or it may pop out unexpectedly.

Do not remove the Memory Stick media while the Memory Stick Duo/PRO Duo media indicator is turned on. If you do, you may lose data. Large volumes of data may take time to load, so be sure the indicator is off before removing the Memory Stick media.

Using Other Memory Cards

Your computer is delivered with the memory card adapter for the ExpressCard slot to support the following memory cards besides the ExpressCard module:

- Standard-size Memory Stick and Memory Stick PRO
- Secure Digital (SD)
- MultiMediaCard (MMC)
- xD-Picture Card



The MagicGate feature of the Memory Stick media and the Memory Stick PRO media is not supported.

The copyright protection and high-speed data transfer features of the SD memory card are not supported.

SD memory cards with capacity of up to 2 GB and SD High Capacity (SDHC) memory cards with capacity of up to 4 GB have been tested and found compatible with your computer.

As for the Memory Stick PRO media, only Sony branded media is recommended to use with the adapter.

Your computer has been tested and found compatible only with major memory card media available as of January 2007. However, not all memory card media that meet the same conditions as the compatible media are guaranteed of compatibility.

Inserting a Memory Card

To insert a memory card to the memory card adapter

- 1 Insert any one of the memory cards (2) to the memory card adapter (1).

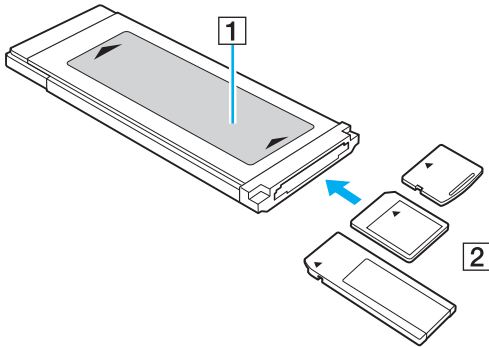

! Make sure to insert a memory card into the memory card adapter in the correct direction to avoid possible damage to the memory card adapter.

- 2 See **Inserting an ExpressCard Module** (page 47) to insert the memory card adapter into the ExpressCard slot.

Removing a Memory Card

To remove a memory card from the memory card adapter

See **Removing an ExpressCard Module (page 49)** to remove the memory card adapter from the ExpressCard slot. Then, firmly grasp the extended part of the memory card and carefully pull it out of the memory card adapter.

Using the Internet

Setting Up a Dial-up Internet Connection

Before you can connect to the Internet, you need to connect your computer to a telephone line with a telephone cable (not supplied). Once you have set up your telephone cable connection, you are ready to connect to the Internet.

To connect a telephone cable

- 1 Plug one end of the phone cable (1) into the modem port  on the computer.
- 2 Plug the other end into the wall jack (2).

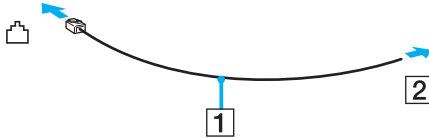

 Your computer does not work with party lines, cannot be connected to a coin-operated telephone, and may not work with multiple telephone lines or a private branch exchange (PBX). Some of these connections may result in excess electrical current and could cause a malfunction in the internal modem.

If you connect a telephone cable coming through a splitter, the modem or connected device may not work properly.

To set up a dial-up connection to the Internet

- 1 Click **Start** and **Control Panel**
- 2 Click **Connect to the Internet** under **Network and Internet**.
The **Connect to the Internet** window appears.
- 3 Click **Dial-up**.
- 4 Follow the on-screen instructions.

Using Wireless LAN (WLAN)

Using the Sony Wireless LAN (WLAN), all your digital devices with built-in WLAN functionality communicate freely with each other through a network. A WLAN is a network in which a user can connect to a Local Area Network (LAN) through a wireless (radio) connection. So there is no need anymore to pull cables or wires through walls and ceilings.

The Sony WLAN supports all normal Ethernet connectivity, but with the added benefits of mobility and roaming. You can still access information, Internet/intranet and network resources, even in the middle of a meeting, or as you move from one place to another.

You can communicate without an access point, which means that you can communicate with a limited number of computers (ad-hoc). Or you can communicate through an access point, which allows you to create a full infrastructure network.

Wireless WAN models

See the **SmartWi Connection Utility Help** for setting up wireless LAN and wireless WAN functionalities. For instructions on how to access the **SmartWi Connection Utility Help**, see **Non-printed Documentation (page 7)**.

Other models

See the following for setting up wireless LAN functionality.



In some countries, using WLAN products may be restricted by the local regulations (e.g. limited number of channels). Therefore, before activating the WLAN functionality, read the **Safety Information** carefully.

WLAN uses the IEEE 802.11a^{*}/b/g standard or the draft form of the IEEE 802.11n^{*} standard, which specifies the used technology. The standard includes the encryption methods: Wired Equivalent Privacy (WEP), which is a security protocol, Wi-Fi Protected Access 2 (WPA2), and Wi-Fi Protected Access (WPA). Proposed jointly by the IEEE and Wi-Fi Alliance, both WPA2 and WPA are specifications of standards based, interoperable security enhancements that increase the level of data protection and access control for existing Wi-Fi networks. WPA has been designed to be forward compatible with the IEEE 802.11i specification. It utilizes the enhanced data encryption TKIP (Temporal Key Integrity Protocol) in addition to user authentication using 802.1X and EAP (Extensible Authentication Protocol). Data encryption protects the vulnerable wireless link between clients and access points. Besides that, there are other typical LAN security mechanisms to ensure privacy, such as: password protection, end-to-end encryption, virtual private networks, and authentication. WPA2, the second generation of WPA, provides stronger data protection and network access control and is also designed to secure all versions of 802.11 devices, including 802.11b, 802.11a, 802.11g, and 802.11n, multi-band and multi-mode. In addition, based on the ratified IEEE 802.11i standard, WPA2 provides government grade security by implementing the National Institute of Standards and Technology (NIST) FIPS 140-2 compliant AES encryption algorithm and 802.1X-based authentication. WPA2 is backward compatible with WPA.

* See the online **Specifications** to see whether your model supports the IEEE 802.11a standard and/or the draft form of the IEEE 802.11n standard.

IEEE 802.11b/g is a wireless LAN standard, using the 2.4 GHz bandwidth. The IEEE 802.11g standard provides high-speed communications, faster than the IEEE 802.11b standard.

IEEE 802.11a is a wireless LAN standard, using the 5 GHz bandwidth, and provides high-speed communications of up to 54 Mbps.

IEEE 802.11n is a wireless LAN standard, using the 2.4 or 5 GHz bandwidth, and provides high-speed communications of up to 300 Mbps^{*}.

* Actual communication speed varies depending on your access point settings and so on.

Your computer may employ the Intel[®] Next-Gen Wireless-N technology^{*} compliant with the IEEE 802.11a/b/g standard and the draft form of the IEEE 802.11n standard. To connect the computer with the Intel[®] Next-Gen Wireless-N technology to an access point using the draft form of the IEEE 802.11n standard, the access point that supports the "Connect with Intel[®] Centrino[®]" program is required.

* Employed only on models that support the draft form of the IEEE 802.11n standard.

Wireless LAN devices using the 2.4 GHz bandwidth and the ones using the 5 GHz bandwidth cannot communicate with each other because the frequencies are different.

The 2.4 GHz bandwidth used by wireless LAN compatible devices is also used by other various devices. Although technologies to minimize interference from other devices that use the same bandwidth are employed on wireless LAN compatible devices, such interference may cause lower communication speed, narrower communication range, or broken wireless connections.

The communication speed varies depending on the distance between communication devices, existence of obstacles between such devices, the device configuration, the radio conditions, and the software in use. In addition, communications may be cut off depending on the radio conditions.

The communication range varies depending on the actual distance between communication devices, existence of obstacles between such devices, the radio conditions, the ambient environment that includes existence of walls and materials of such walls, and the software in use.

Deploying IEEE 802.11b and IEEE 802.11g products on the same wireless network may reduce the communication speed due to radio interference. Taking this into consideration, the IEEE 802.11g products are designed to reduce the communication speed to ensure communications with IEEE 802.11b products. When the communication speed is not as fast as expected, changing the wireless channel on the access point may increase the communication speed.

Communicating without an Access Point (Ad-hoc)

An ad-hoc network is a network in which a LAN is created only by the wireless devices themselves, with no other central controller or access point. Each device communicates directly with other devices in the network. You can set up an ad-hoc network easily at home.

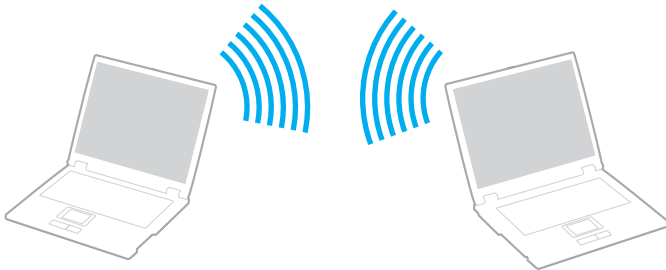

- ❑ If the wireless connection is initiated by the VAIO computer, channel 11 will be selected.
- ❑ If the wireless connection is initiated by peer wireless LAN equipment, the wireless LAN communication will make use of the channel selected by the peer wireless LAN equipment.



To communicate without an access point (ad-hoc)

! You cannot select the 5 GHz bandwidth, which is used for the IEEE 802.11a standard, on ad-hoc networks.

The IEEE 802.11n standard, using the 2.4 or 5 GHz bandwidth, is not available on ad-hoc networks.

- 1 Turn on the **WIRELESS** or **WIRELESS LAN** switch.
The Wireless LAN indicator lights up.
- 2 Double-click  ( / ) on the taskbar to display the **Wireless Device Switch** window. Select your desired wireless option(s) and click **OK**.
- 3 Click **Start** and **Control Panel**.
- 4 Click **View network status and tasks** under **Network and Internet**.
- 5 Click **Set up a connection or network** on the left pane.
The **Set up a connection or network** window appears.
- 6 Select an option to specify the ad-hoc network settings and click **Next**.
- 7 Follow the on-screen instructions.



See the online **Specifications** to see whether your model supports the Bluetooth functionality, the IEEE 802.11a/b/g standard, and/or the draft form of the IEEE 802.11n standard.

Communicating with an Access Point (Infrastructure)



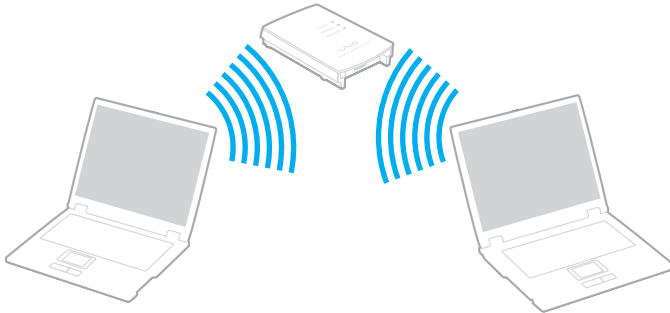

An infrastructure network is a network that extends an existing wired local network to wireless devices by providing an access point (not supplied), for example the Sony Access Point. The access point bridges the wireless and wired LAN and acts as a central controller for the wireless LAN. The access point coordinates transmission and reception from multiple wireless devices within a specific range.

The access point will select which channel to use on an infrastructure network.

! For details on how to select the channel that will be used by the access point, see the manual that came with your access point.



To connect to a wireless network

- 1 Make sure an access point is set up.
See the manual that came with your access point for more information.
- 2 Turn on the **WIRELESS** or **WIRELESS LAN** switch.
The Wireless LAN indicator lights up.
- 3 Double-click  ( / ) on the taskbar to display the **Wireless Device Switch** window. Select your desired wireless option(s) and click **OK**.
- 4 Right-click  or  on the taskbar and select **Connect to a network**.
- 5 Select the desired access point and click **Connect**.



See the online **Specifications** to see whether your model supports the Bluetooth functionality, the IEEE 802.11a/b/g standard, and/or the draft form of the IEEE 802.11n standard.

To disconnect from a wireless network

Turn off the **WIRELESS** or **WIRELESS LAN** switch.



Turning off the wireless LAN functionality while accessing remote documents, files, or resources may result in data loss.





For WPA-PSK or WPA2-PSK authentication, you must enter a passphrase. The passphrase is case sensitive and must be between 8 and 63 alphanumeric characters long or up to 64 characters long using numbers from 0 to 9 and letters from A to F.

Using the Bluetooth Functionality

You can establish wireless communication between your computer and other Bluetooth devices such as another computer or a mobile phone. You can transfer data between these devices without cables and up to 33 feet (10 meters) range in open space.

- ❑ Wireless WAN models
See the **SmartWi Connection Utility Help** for setting up Bluetooth functionality. For instructions on how to access the **SmartWi Connection Utility Help**, see **Non-printed Documentation (page 7)**.
- ❑ Other models
See the following for setting up Bluetooth functionality.

To connect to a Bluetooth device

- 1 Turn on the **WIRELESS** switch.
- 2 Double-click  ( / ) on the taskbar to display the **Wireless Device Switch** window.
- 3 Select the **Enable Bluetooth Device** option.
- 4 Click **OK**.

Notes on using the Bluetooth functionality

- ❑ The data transfer rate varies, depending on the following conditions:
 - ❑ Obstacles, such as walls, located between devices
 - ❑ Distance between devices
 - ❑ Material used in walls
 - ❑ Proximity to microwaves and cordless telephones
 - ❑ Radio frequency interference and other environmental conditions
 - ❑ Device configuration
 - ❑ Type of software application
 - ❑ Type of operating system
 - ❑ Use of both wireless LAN and Bluetooth functionalities at the same time on your computer
 - ❑ Size of file being exchanged
- ❑ Note that due to limitations of the Bluetooth standard, large files may occasionally be corrupted during continuous transfer due to electromagnetic interference from the environment.
- ❑ All Bluetooth devices must be certified to make sure that the applicable standard requirements are maintained. Even if standards are met, individual device performance, specifications, and operation procedures can vary. Data exchange may not be possible in all situations.
- ❑ As general characteristics of Bluetooth technology, video and audio may go out of synchronization if you play videos on your computer with audio output from the connected Bluetooth device.

- ❑ The 2.4 GHz band, with which Bluetooth devices or wireless LAN devices work, is used by various devices. Bluetooth devices use the technology to minimize the interference from other devices that use the same wave length. Simultaneous use of the Bluetooth functionality and wireless communication devices, however, may cause radio interference and result in poorer communication speeds and distances than the standard values.
- ❑ The Bluetooth functionality may not work depending on the third party devices or the software version used by third party companies.
- ❑ As general characteristics of Bluetooth technology, connecting multiple Bluetooth devices to your computer may cause bandwidth congestion, resulting in poor performance of the devices.

Bluetooth Security

The Bluetooth wireless technology has an authentication function, which allows you to determine with whom you choose to communicate. With the authentication function, you can avoid any anonymous Bluetooth device to access your computer.

The first time two Bluetooth devices communicate, a common passkey (a password required for authentication) should be determined for both devices to be registered. Once a device is registered, there is no need to re-enter the passkey.



The passkey can be different each time, but must be the same at both ends.

For certain devices, such as a mouse, no passkey can be entered.

Communicating with Another Bluetooth Device

You can connect your computer to a Bluetooth device such as another computer, a mobile phone, a PDA, a headset, a mouse, or a digital camera without the use of any cables.



To communicate with another Bluetooth device

To communicate with another Bluetooth device, you need first to set up the Bluetooth functionality. For setting up and using the Bluetooth functionality, see the help file on the Bluetooth utility software.

To see the help file

- 1 Right-click the Bluetooth icon  on the taskbar, and select **Help** from the menu.

Stopping the Bluetooth Connection

To stop the Bluetooth connection, turn off the **WIRELESS** switch. The Bluetooth indicator turns off.

Using the Bluetooth Headset

The Bluetooth headset (not supplied) will come in handy during a video conference over the Internet using instant messaging software. For details on using the Bluetooth headset, see the manual that came with your Bluetooth headset.

To connect the headset with your computer

- 1 Press and hold the headset power button for at least five seconds to turn on the Bluetooth headset.
- 2 Press and hold the volume buttons for at least five seconds until the indicator light blinks in red and green.
- 3 Right-click the Bluetooth icon  on the taskbar and select **Bluetooth Settings** from the menu.
The **Bluetooth Settings** window appears and **Add New Connection Wizard** automatically starts.
- 4 If the **Add New Connection Wizard** window does not appear, click **New Connection**.
The **Add New Connection Wizard** window appears.
- 5 Select **Express Mode (Recommended)** and then click **Next**.
The wizard searches for Bluetooth devices in range and lists available devices, if any.
- 6 Select the device name for your Bluetooth headset and then click **Next**.
The **Bluetooth Manager-Bluetooth Security** window appears when a connection is established.
- 7 Enter "0000" for **Bluetooth Passkey (PIN)** and then click **OK**.
- 8 Click **Next**.
The headset icon appears in the **Bluetooth Settings** window.
- 9 Right-click the icon and select **Connect** from the menu.

To disconnect the headset from your computer

- 1 Right-click the Bluetooth icon  on the taskbar and select **Bluetooth Settings** from the menu. The **Bluetooth Settings** window appears.
- 2 Right-click the headset icon and select **Disconnect** from the menu.
- 3 Click **Yes**.

Using Peripheral Devices

You can add functionality to your VAIO computer by using the various ports on the computer.

- ❑ **Connecting a Docking Station** ([page 75](#))
- ❑ **Connecting External Speakers** ([page 84](#))
- ❑ **Connecting an External Display** ([page 85](#))
- ❑ **Selecting Display Modes** ([page 89](#))
- ❑ **Using the Multiple Monitors Function** ([page 92](#))
- ❑ **Connecting an External Microphone** ([page 94](#))
- ❑ **Connecting a Universal Serial Bus (USB) Device** ([page 95](#))
- ❑ **Connecting a Printer** ([page 98](#))
- ❑ **Connecting an i.LINK Device** ([page 99](#))
- ❑ **Connecting to a Network (LAN)** ([page 101](#))

Connecting a Docking Station

Attaching a docking station enables you to connect additional peripherals to your computer, such as a printer and an external display.

The docking station is not supplied with your computer and is available as an optional accessory.

Locating Ports on the Docking Station

Back

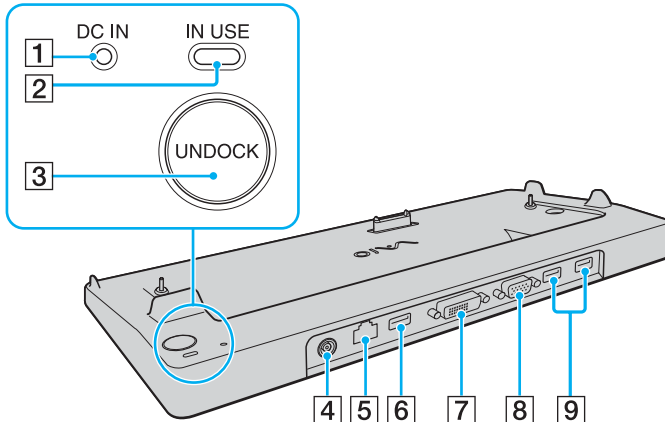

- 1 DC IN** indicator
Illuminates when the docking station is powered.
 - 2 IN USE** indicator ([page 80](#))
 - 3 UNDOCK** button ([page 80](#))
 - 4 DC IN** port ([page 76](#))
 - 5** Network (Ethernet) port (1000BASE-T / 100BASE-TX / 10BASE-T) ([page 101](#))
 - 6** Hi-Speed USB (USB 2.0) port* ([page 95](#))
 - 7 DVI-D** port ([page 86](#))
 - 8 MONITOR** (VGA) port ([page 86](#))
 - 9** Hi-Speed USB (USB 2.0) ports* ([page 95](#))
- * Supports high-/full-/low- speeds.

! The docking station can be powered only through the AC adapter supplied with your computer. Do not unplug the AC adapter from the docking station and the AC outlet while using the docking station; this may cause data damage or hardware malfunctions.

Attaching Your Computer to the Docking Station

! When your computer has no battery pack installed, do not attach the computer to the docking station.

To attach your computer to the docking station

! Use the AC adapter supplied with your computer.

Do not move your computer while attached to the docking station; this may detach the docking station and cause damage to both units.

- 1 Disconnect all peripherals from the computer.
- 2 Plug one end of the power cord (1) into the AC adapter (2) and the other end into an AC outlet.
- 3 Plug the cable attached to the AC adapter (2) into the **DC IN** port (3) on the docking station (4).

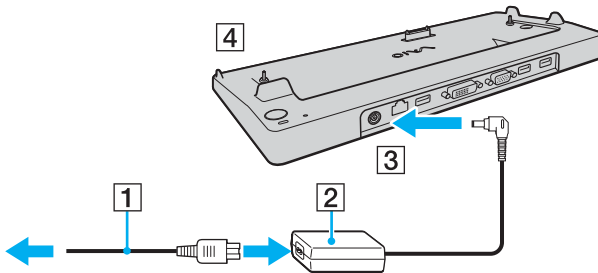

- 4 Slide open the docking station connector cover on the bottom of the computer.

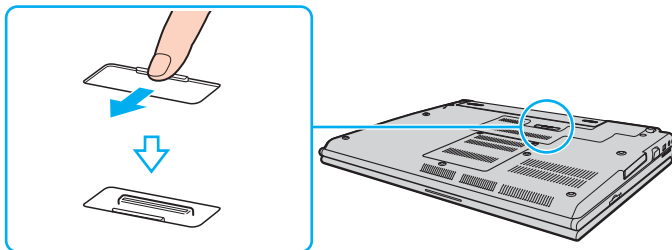

- 5 Align the rear bottom corners of the computer with the guides on the docking station.

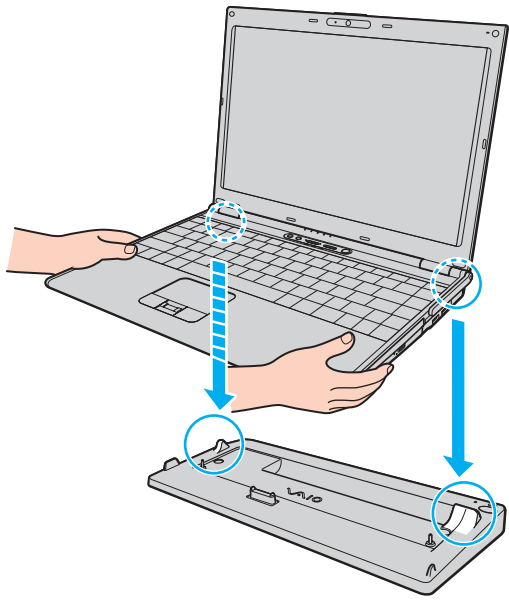

- 6 Gently push down the computer until it clicks into place.

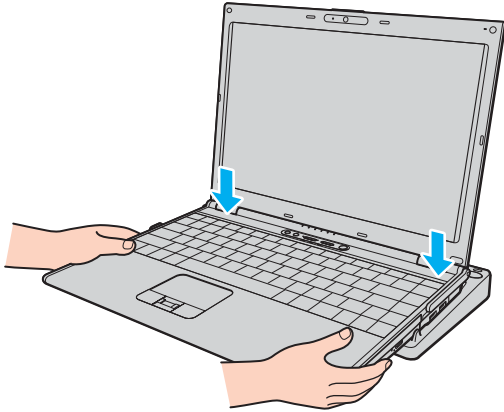

- 7 Turn on the computer.

Disconnecting Your Computer from the Docking Station



Be sure that no devices connected to the docking station are in use before disconnecting your computer.

Do not disconnect your computer from the docking station when the **IN USE** indicator is lit. Disconnecting the computer while the **IN USE** indicator is lit may result in loss of unsaved data or a failure of the computer.

When the battery pack is running out of power, disconnecting your computer from the docking station may result in loss of unsaved data.

Do not disconnect your computer from the docking station during video playback. Be sure to close video playback software before disconnection.

Once you have completed the steps in **To disconnect your computer from the docking station (page 81)**, make sure to place your computer off the docking station. Use of the computer still on the docking station may cause unstable operations.

To disconnect your computer from the docking station

- 1 Press the **UNDOCK** button (1) and wait until the **IN USE** indicator (2) turns off.

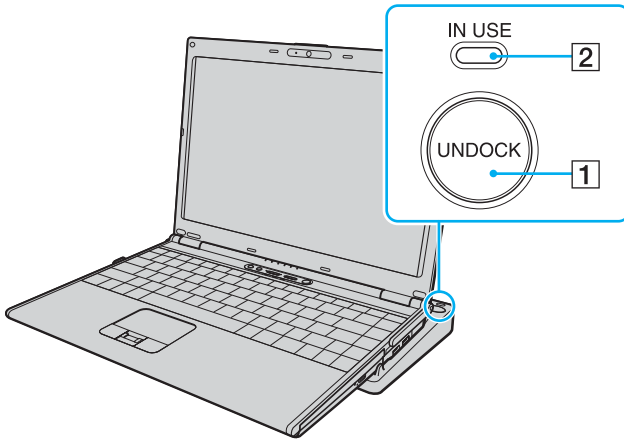

If the **IN USE** indicator is unlit, you do not have to press the **UNDOCK** button.

Pressing the **UNDOCK** button while your computer is in a power saving mode returns the computer to Normal mode first, and then initiates the disconnection process.



Once you have placed your computer back in Normal mode, make sure to place your computer off the docking station. Use of the computer still on the docking station may cause unstable operations.

- 2 Lift the computer away from the docking station.

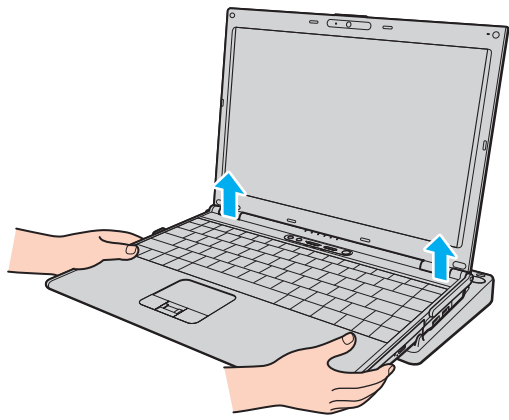

- 3 Close the docking station connector cover on the bottom of the computer.

Alternatively, you can disconnect the computer from the docking station as follows:

- 1 Click **Start** and **Undock Computer**.
- 2 Make sure that a message balloon appears and the **IN USE** indicator turns off; and then lift the computer away from the docking station.
- 3 Close the docking station connector cover on the bottom of the computer.



It is extremely important to close the docking station connector cover after disconnecting your computer from the docking station. If the cover is left open, dust may get inside and damage the computer.

To disconnect the docking station completely from AC power, unplug the AC adapter.

Connecting External Speakers

You can enhance the sound quality of your computer by connecting external speakers.

To connect external speakers

- 1 Plug the speaker cable (1) into the headphones jack (2) 🎧.
- 2 Plug the other end of the speaker cable to the external speaker (3).
- 3 Turn down the volume of the speakers before you turn them on.

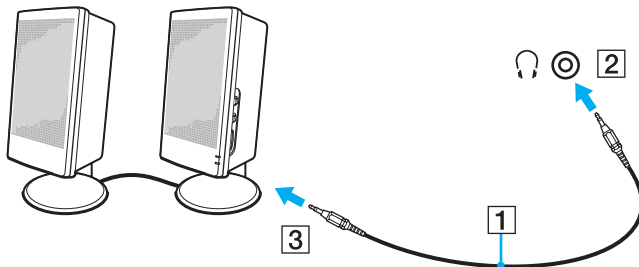

Make sure your speakers are designed for computer use.



Do not place floppy disks on the speakers; their magnetic field may damage the data on the disks.

Connecting an External Display

You can connect an external display (not supplied) to your computer. For example, you can use the computer with a computer display or a projector.



Connect the power cord after connecting all other cables.

Connected external displays are used as secondary screens.

On the Windows operating system, you can also use an external display to set up multiple monitors.

Connecting a Computer Display

You can connect a computer display (monitor) either directly to your computer or via the optional docking station.

To connect a computer display

- 1 If necessary, plug one end of the display's power cord (1) into your display, and the other end into an AC outlet.
- 2 If you want to connect a VGA monitor, plug the display cable (2) (not supplied) into the monitor (VGA) port (3) on the computer or on the docking station.
- 3 If you want to connect a TFT/DVI monitor, plug the display cable (not supplied) into the **DVI-D** port on the docking station.

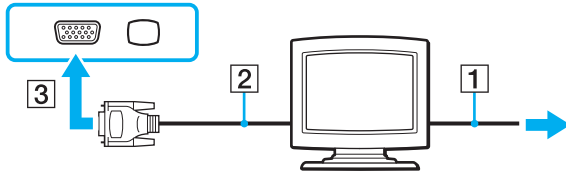

 DVI-D stands for Digital Visual Interface - Digital. It is a type of DVI connector that supports only digital video signals (no analog video signals). It has 24 pins.

A DVI-I (Digital Visual Interface - Integrated) connector supports digital video and analog video signals. It has 29 pins.

! You can use a TFT/DVI monitor only when your computer is in SPEED mode. See **Selecting Performance Modes (page 104)** for mode selection.

Connecting a Multimedia Computer Display

You can connect a multimedia computer display that includes built-in speakers and a microphone either directly to your computer or via the optional docking station.

To connect a multimedia computer display

- 1 Plug the power cord of your multimedia computer display (1) into an AC outlet.
- 2 Plug the display cable (2) (not supplied) into the monitor (VGA) port (3) □ on the computer or on the docking station.
- 3 Plug the speaker cable (4) into the headphones jack (5) 🎧 on the computer.
- 4 Plug the microphone cable (6) into the microphone jack (7) 🎤 on the computer.

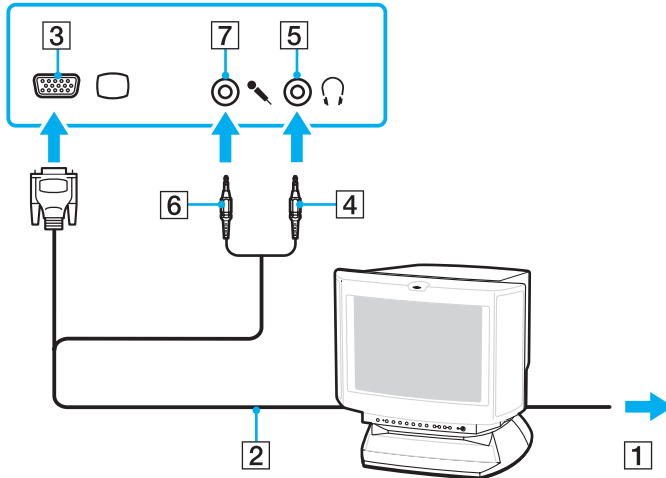

Connecting a Projector

You can connect a projector (for example, the Sony LCD projector) either directly to your computer or via the optional docking station.

To connect a projector

- 1 Connect the power cord (1) of your projector into an AC outlet.
- 2 Plug an RGB signal cable (2) (not supplied) into the monitor (VGA) port (3) □ on the computer or on the docking station.
- 3 Plug an audio cable (4) (not supplied) into the headphones jack (5) 🎧 on the computer.
- 4 Plug the RGB signal cable and the audio cable into the jack and port on the projector (6).

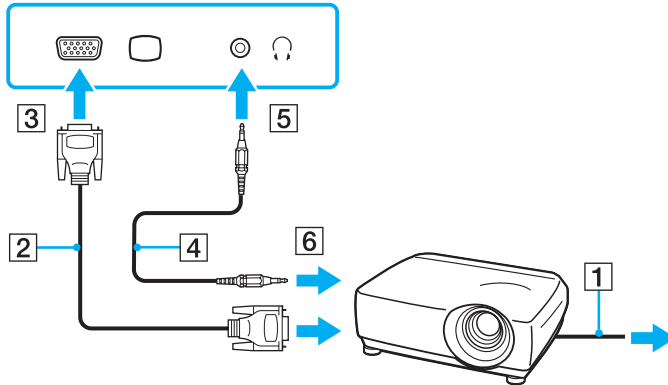

Selecting Display Modes

You can select which display to be used as the primary monitor when an external display (desktop monitor, etc.) is connected to your computer.

If you want to work on your computer screen and the external display at the same time, see **Using the Multiple Monitors Function** ([page 92](#)) for more information.

To select a display

When using the Intel Graphics Media Accelerator (STAMINA mode)

- 1 Right-click on the desktop and select **Personalize** from the shortcut menu.
- 2 Click **Display Settings**.
The **Display Settings** window appears.
- 3 Follow the on-screen instructions to change the settings.



You may not be able to display the same contents on your computer screen and the external display or projector at the same time, depending on the type of your external display or projector.

Before turning on your computer, turn on the peripheral devices.

When using the NVIDIA video controller (SPEED mode)

- 1 Click **Start** and **Control Panel**.
- 2 Click **Additional Options**.
- 3 Click **NVIDIA Control Panel**.
- 4 Click **Display**.
- 5 Click **Change Display Configuration**.
- 6 Follow the on-screen instructions to change the settings.



You may not be able to display the same contents on your computer screen and the external display or projector at the same time, depending on the type of your external display or projector.

Before turning on your computer, turn on the peripheral devices.

For selecting a video controller, see **Selecting Performance Modes** ([page 104](#)).

Using the Multiple Monitors Function

The Multiple Monitors function allows you to distribute portions of your desktop across separate displays. For example, if you have an external display connected to the monitor (VGA) port, your computer screen and the external display can function as a single desktop.

You can move the cursor from one display to the other. This allows you to drag objects, such as an open application window or a toolbar, from one display to the other.

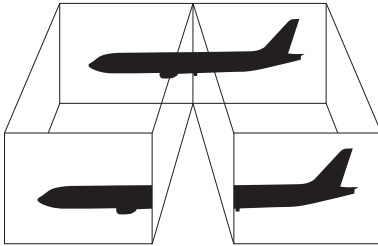

Your external display may not support the Multiple Monitors function.

Certain software applications may not be compatible with Multiple Monitors settings.

Make sure that your computer does not enter Sleep or Hibernate mode while you are using Multiple Monitors mode; otherwise the computer may not return to Normal mode.

If you set different colors on each display, do not expand a single window across two displays; otherwise your software may not work properly.

Set fewer colors or a lower resolution for each display.

To select the Multiple Monitors mode

When using the Intel Graphics Media Accelerator (STAMINA mode)

- 1 Right-click on the desktop and select **Personalize** from the shortcut menu.
- 2 Click **Display Settings**.
The **Display Settings** window appears.
- 3 Follow the on-screen instructions to change the settings.

When using the NVIDIA video controller (SPEED mode)

- 1 Click **Start** and **Control Panel**.
- 2 Click **Adjust screen resolution** under **Appearance and Personalization**.
The **Display Settings** window appears.
- 3 Right-click the number **2** monitor and select **Attached**.
- 4 Click **OK**.
At the confirmation prompt, click **Yes**.



For selecting a video controller, see **Selecting Performance Modes (page 104)**.

You can also change one of the **S** button assignments to activate the Multiple Monitors mode with the corresponding **S** button. To change the **S** button assignments, press and hold any **S** button to display the window for changing the assignment. For details on the **S** buttons, see **Using Special-function Buttons (page 32)**.

Additionally, you can set the display colors and resolution for each display and customize the Multiple Monitors mode.

Connecting an External Microphone

If you need to use a sound input device (for example, to chat over the Internet) you need to plug in an external microphone (not supplied).

To connect an external microphone

Plug the microphone cable (1) into the microphone jack (2) .

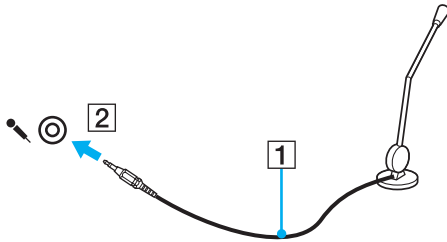

Make sure your microphone is designed for computer use.

Connecting a Universal Serial Bus (USB) Device

To prevent your computer and/or USB devices from damage, observe the following:

- ❑ When moving the computer with USB devices connected, avoid any shock or force to the USB ports.
- ❑ Do not put the computer into a bag or carrying case when it has USB devices connected.

Connecting a USB Mouse

To connect a USB mouse

- 1 Choose the USB port (1)  you prefer to use.
- 2 Plug the USB mouse cable (2) into the USB port.
- 3 You can now use your USB mouse (not supplied) (3).

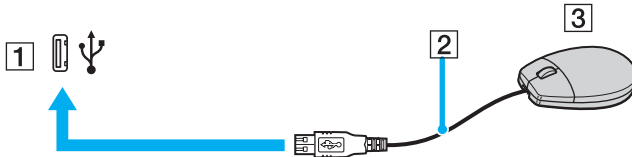

Connecting a USB Floppy Disk Drive

You can purchase a USB floppy disk drive and connect it to your computer.

To connect a USB floppy disk drive

- 1 Choose the USB port (1)  you prefer to use.
- 2 Plug the USB floppy disk drive cable (2) into the USB port.
Your USB floppy disk drive (3) is now ready for use.

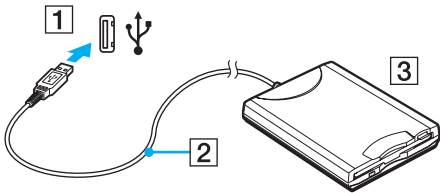

! When using a USB floppy disk drive, do not apply force on the USB port. This may cause a malfunction.

Disconnecting a USB floppy disk drive

You can disconnect a USB floppy disk drive when your computer is on or off. Disconnecting the drive when the computer is in a power saving mode (Sleep or Hibernate) may cause the computer to malfunction.

To disconnect a USB floppy disk drive



To disconnect a USB floppy disk drive when your computer is off, skip steps 1 to 8.

- 1 Close all programs accessing the floppy disk drive.
- 2 Double-click the **Safely Remove Hardware** icon on the taskbar.
The **Safely Remove Hardware** window appears.
- 3 Select the floppy disk drive you want to unplug.
- 4 Click **Stop**.
The **Stop a Hardware device** window appears.
- 5 Confirm that the floppy disk drive can be safely removed from the system.
- 6 Click **OK**.
A message appears stating it is now safe to remove the hardware device.
- 7 Click **OK**.
- 8 Click **Close** to close the **Safely Remove Hardware** window.
- 9 Disconnect the floppy disk drive from the computer.

Connecting a Printer

You can connect a Windows-compatible printer to your computer to print documents.

Connecting a Printer Using the USB Port

You can connect a USB printer compatible with your version of Windows to the computer.

To connect a printer using the USB port

- 1 Plug the power cord (1) of your printer into an AC outlet.
- 2 Choose the USB port (3)  you prefer to use.
- 3 Plug one end of a USB printer cable (2) (not supplied) into the USB port and the other end to your printer.

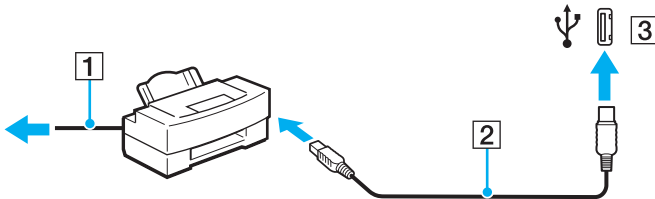

Connecting an i.LINK Device

Notes on connecting i.LINK devices

- ❑ Your computer is equipped with an i.LINK port, which you can use to connect to an i.LINK device such as a digital video camcorder.
- ❑ The i.LINK port on your computer does not supply power to external devices generally powered by i.LINK ports.
- ❑ The i.LINK port supports transfer rates up to 400 Mbps; however, the actual transfer rate depends on the transfer rate of the external device.
- ❑ The optional i.LINK cables may not be available, depending on the country or area of your residency.
- ❑ An i.LINK connection with other compatible devices is not fully guaranteed.
- ❑ The i.LINK connection varies depending on the software applications, operating system, and i.LINK-compatible devices you use. See the manual that came with your software for more information.
- ❑ Check the working conditions and operating system compatibility of i.LINK-compatible PC peripherals (for example, an HDD or a CD-RW drive) before you connect them to your computer.

Connecting a Digital Video Camcorder

To connect a digital video camcorder

Plug one end of an i.LINK cable (1) (not supplied) into the i.LINK port (2) on the computer and the other end into the DV In/Out port (3) on the digital video camcorder.

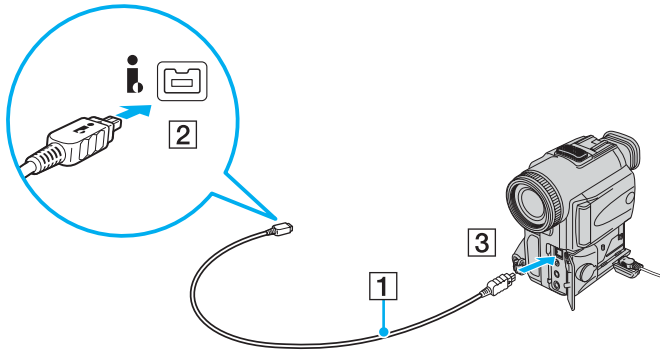

On Sony digital video cameras, ports labeled **DV Out**, **DV In/Out**, or **i.LINK** are i.LINK-compatible.

The Sony digital video camcorder shown here is an example; your digital video camcorder may need to be connected differently.

You cannot access the pictures stored on a Memory Stick media when using an i.LINK connection.

Connecting to a Network (LAN)

You can connect your computer to 1000BASE-T/100BASE-TX/10BASE-T-type networks with an Ethernet network cable. Connect one end of a network cable (not supplied) to the network (Ethernet) port on the computer or the optional docking station and the other end to your network. For detailed settings and devices needed to connect to the network, ask your network administrator.

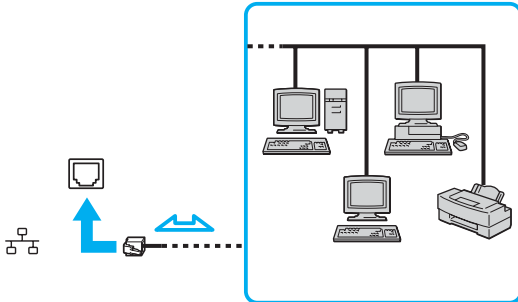

Your computer can be connected to the network with the default settings.

When your computer is attached to the optional docking station, you need to select which network (Ethernet) port to use. Follow the on-screen instructions.

! Telephone lines cannot be connected to the network (LAN) connector on your computer. If the network (LAN) connector is connected to the telephone lines mentioned below, high electric current to the connector may cause damage, overheating, or fire.

- Home (intercom speakerphone) or business-use telephone lines (multi-line business telephone)
- Public telephone subscriber line
- PBX (private branch exchange)

Do not plug a telephone cable into the network port.

Customizing Your VAIO Computer

This section briefly describes how to change the main settings of your VAIO computer. Among other things, you will learn how to use and customize the look of your Sony software and utilities, etc.

- ❑ **Selecting Performance Modes** ([page 104](#))
- ❑ **Setting the Password** ([page 105](#))
- ❑ **Using Fingerprint Authentication** ([page 116](#))
- ❑ **Using Trusted Platform Module (TPM)** ([page 124](#))
- ❑ **Setting Up Your Computer with VAIO Central** ([page 131](#))
- ❑ **Using VAIO Status Monitor** ([page 132](#))
- ❑ **Using the Power Saving Modes** ([page 133](#))
- ❑ **Managing Power with VAIO Power Management** ([page 138](#))
- ❑ **Protecting the Hard Disk** ([page 141](#))

Selecting Performance Modes

Your computer is equipped with the performance selector switch (1) to select a performance mode for lower power consumption or faster performance.

! Once you have changed the performance mode with the performance selector switch, you must restart your computer to place it into the selected mode. A window appears to prompt you for computer restart.

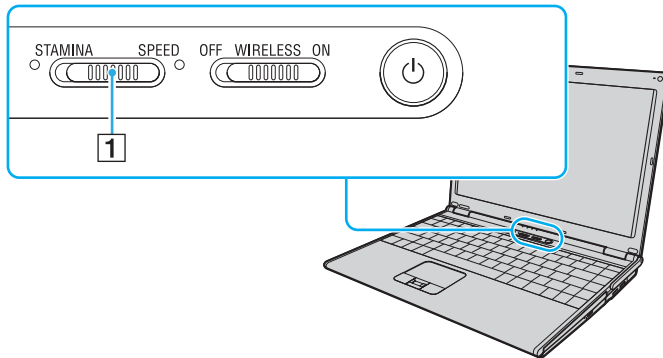

- STAMINA** mode
Uses the Intel Graphics Media Accelerator to conserve battery power.
- SPEED** mode
Uses the NVIDIA video controller to provide faster performance.



You can find the current performance mode by the lit indicator on either side of the performance selector switch.

Setting the Password

In addition to the Windows password, you can use BIOS functions to set two types of passwords to protect your computer: power-on password and hard disk password.

Once you have set the power-on password, you will be prompted to enter the password after the VAIO logo appears to start your computer. The power-on password allows you to protect your computer from unauthorized access.

The hard disk password provides additional security for the data stored on your hard disk drive. If you set the hard disk password, no other users will be able to access the data without knowing the password, even if the password-protected hard disk drive is installed in another computer.

Adding the Power-on Password

The power-on password is provided to protect your computer from unauthorized access.

There are two types of the power-on password: machine password and user password. The machine password is provided for users with administrator rights on the computer to change all the setup options on the BIOS setup screen, as well as to start the computer. The user password is provided for other standard users to allow for changing some of the BIOS setup options, as well as starting the computer. To set the user password, you must first set the machine password.



Once you have set the power-on password, you cannot start your computer without entering the password. Make sure not to forget the password. Write down your password and keep it safe and private from other people.

If you forget the power-on password and need assistance to reset it, a password reset fee will be charged, and your computer may need to be sent in for depot service for password reset.



If you have set the power-on password in conjunction with the fingerprint authentication functionality, you can substitute fingerprint authentication for password entry when turning on your computer. For more information, see **Using Fingerprint Authentication (page 116)**.

To add the power-on password (machine password)

- 1 Turn on the computer.
- 2 Press the **F2** key when the VAIO logo appears.
The BIOS setup screen appears. If not, restart the computer and press the **F2** key several times when the VAIO logo appears.
- 3 Press the **←** or **→** key to select **Security** to display the **Security** tab, select **Set Machine Password**, and then press the **Enter** key.
- 4 On the password entry screen, enter the password twice and press the **Enter** key.
The password can be up to 32 alphanumeric characters (including spaces) long.
- 5 Select **Password when Power On** under **Security**.
Press the space bar to change the setting from **Disabled** to **Enabled**.
- 6 Press the **←** or **→** key to select **Exit**, select **Exit Setup**, and then press the **Enter** key.
At the confirmation prompt, press the **Enter** key.

To add the power-on password (user password)

! Make sure you set the machine password before setting the user password.

- 1 Turn on the computer.
- 2 Press the **F2** key when the VAIO logo appears.
The BIOS setup screen appears. If not, restart the computer and press the **F2** key several times when the VAIO logo appears.
- 3 Enter the machine password and press the **Enter** key.
- 4 Press the **←** or **→** key to select **Security** to display the **Security** tab, select **Set User Password**, and then press the **Enter** key.
- 5 On the password entry screen, enter the password twice and press the **Enter** key.
The password can be up to 32 alphanumeric characters (including spaces) long.
- 6 Press the **←** or **→** key to select **Exit**, select **Exit Setup**, and then press the **Enter** key.
At the confirmation prompt, press the **Enter** key.

Changing/Removing the Power-on Password

To change or remove the power-on password (machine password)

- 1 Turn on the computer.
- 2 Press the **F2** key when the VAIO logo appears.
The BIOS setup screen appears. If not, restart the computer and press the **F2** key several times when the VAIO logo appears.
- 3 Enter the machine password and press the **Enter** key.
- 4 Press the **←** or **→** key to select **Security** to display the **Security** tab, select **Set Machine Password**, and then press the **Enter** key.
- 5 On the password entry screen, enter the current password once and a new password twice, and then press the **Enter** key.
To remove the password, leave the **Enter New Password** and **Confirm New Password** fields blank and press the **Enter** key.
- 6 Press the **←** or **→** key to select **Exit**, select **Exit Setup**, and then press the **Enter** key.
At the confirmation prompt, press the **Enter** key.

To change or remove the power-on password (user password)

- 1 Turn on the computer.
- 2 Press the **F2** key when the VAIO logo appears.
The BIOS setup screen appears. If not, restart the computer and press the **F2** key several times when the VAIO logo appears.
- 3 Enter the user password and press the **Enter** key.
- 4 Press the **←** or **→** key to select **Security** to display the **Security** tab, select **Set User Password**, and then press the **Enter** key.
- 5 On the password entry screen, enter the current password once and a new password twice, and then press the **Enter** key.
To remove the password, leave the **Enter New Password** and **Confirm New Password** fields blank and press the **Enter** key.
- 6 Press the **←** or **→** key to select **Exit**, select **Exit Setup**, and then press the **Enter** key.
At the confirmation prompt, press the **Enter** key.

Adding the Hard Disk Password

The hard disk password provides additional security for the data stored on your hard disk drive. If you enable the hard disk password, this adds an extra level of security.

When adding the hard disk password, you must set both the master and user passwords. The master password is provided for users with administrator rights on the computer to reset the user password on the BIOS setup screen. The user password is provided to lock your hard disk drive. Once you set the user password, you will have to enter the password along with the power-on password (if set), after the VAIO logo appears.



You cannot start your computer with the master password.

If you forget the master password or the keyboard fails, which is critical to password entry, no bypass is possible and the data stored on the hard disk drive will not be accessible. There is **NO RESET** of this password. You will have to replace the hard disk drive at your own expense and lose all the data stored on the original hard disk drive. Be sure to write down the master password and keep it safe and private from other people.



If you have set the hard disk password in conjunction with the fingerprint authentication functionality, you can substitute fingerprint authentication for password entry when turning on your computer. For more information, see **Using Fingerprint Authentication (page 116)**.

To add the hard disk password

- 1 Turn on the computer.
 - 2 Press the **F2** key when the VAIO logo appears.
The BIOS setup screen appears. If not, restart the computer and press the **F2** key several times when the VAIO logo appears.
-  If you have set the power-on password, enter your power-on password.
- 3 Press the **←** or **→** key to select **Security** to display the **Security** tab, select **Hard Disk Password**, and then press the **Enter** key.
The password entry screen appears.
 - 4 Select **Enter Master and User Passwords** and press the **Enter** key.
 - 5 Select **Continue** on the warning screen and press the **Enter** key.
 - 6 Enter the master password twice and press the **Enter** key.
The password should be up to 32 alphanumeric characters (including spaces) long.
 - 7 Enter the user password twice and press the **Enter** key.
The password should be up to 32 alphanumeric characters (including spaces) long.
 - 8 At the confirmation prompt, press the **Enter** key.
 - 9 Press the **Esc** key.
 - 10 Press the **←** or **→** key to select **Exit**, select **Exit Setup**, and then press the **Enter** key.
At the confirmation prompt, press the **Enter** key.

Changing the Hard Disk Password

To change the hard disk password

- 1 Turn on the computer.
- 2 Press the **F2** key when the VAIO logo appears.
The BIOS setup screen appears. If not, restart the computer and press the **F2** key several times when the VAIO logo appears.



If you have set the power-on password, enter your power-on password.

- 3 Press the **←** or **→** key to select **Security** to display the **Security** tab, select **Hard Disk Password**, and then press the **Enter** key.
The password entry screen appears.
- 4 Select **Change Master Password** or **Change User Password** and press the **Enter** key.
- 5 Enter the current password once and then a new password twice.
- 6 Press the **Enter** key.
- 7 Press the **Enter** key when the success message appears.
- 8 Press the **Esc** key.
- 9 Press the **←** or **→** key to select **Exit**, select **Exit Setup**, and then press the **Enter** key.
At the confirmation prompt, press the **Enter** key.

Removing the Hard Disk Password

To remove the hard disk password

- 1 Turn on the computer.
- 2 Press the **F2** key when the VAIO logo appears.
The BIOS setup screen appears. If not, restart the computer and press the **F2** key several times when the VAIO logo appears.



If you have set the power-on password, enter your power-on password.

- 3 Press the **←** or **→** key to select **Security** to display the **Security** tab, select **Hard Disk Password**, and then press the **Enter** key.
The password entry screen appears.
- 4 Select **Enter Master and User Passwords** and press the **Enter** key.
- 5 Enter the current password for **Enter Current Hard Disk Master Password** and press the **Enter** key, leaving everything else blank.
- 6 Press the **Enter** key when the success message appears.
- 7 Press the **Esc** key.
- 8 Press the **←** or **→** key to select **Exit**, select **Exit Setup**, and then press the **Enter** key.
At the confirmation prompt, press the **Enter** key.

Adding the Windows Password

The Windows password comes in handy when you have to share a single computer with other people. By setting the Windows password, you can protect your user account from unauthorized access.

Entry of the Windows password will be prompted after you select your user account.

! Make sure not to forget the password. Write down your password and keep it safe and private from other people.



If you have set the Windows password in conjunction with the fingerprint authentication functionality, you can substitute fingerprint authentication for password entry when turning on your computer. For more information, see **Using Fingerprint Authentication (page 116)**.

To add the Windows password

- 1 Click **Start** and **Control Panel**.
- 2 Click **User Accounts and Family Safety** or **User Accounts**.
- 3 Click **User Accounts**.
- 4 Click **Create a password for your account** under **Make changes to your account**.
- 5 In the **New password** and **Confirm new password** fields, enter the password for your account.
- 6 Click **Create password**.



See **Windows Help and Support** for more information on the Windows password.

Changing/Removing the Windows Password

To change the Windows password

- 1 Click **Start** and **Control Panel**.
- 2 Click **User Accounts and Family Safety** or **User Accounts**.
- 3 Click **User Accounts**.
- 4 Click **Change your password**.
- 5 In the **Current password** field, enter your current password.
- 6 In the **New password** and **Confirm new password** fields, enter a new password.
- 7 Click **Change password**.

To remove the Windows password

- 1 Click **Start** and **Control Panel**.
- 2 Click **User Accounts and Family Safety** or **User Accounts**.
- 3 Click **User Accounts**.
- 4 Click **Remove your password**.
- 5 In the **Current password** field, enter the current password that you want to remove.
- 6 Click **Remove password**.

Using Fingerprint Authentication

Your computer is equipped with a fingerprint sensor to provide you with additional convenience. A small horizontal bar located between the left and right touch pad buttons is the sensor of the fingerprint reader and will be referred to as the fingerprint sensor hereinafter.

Once you have registered your fingerprint(s), the fingerprint authentication functionality offers:

- ❑ A substitute for password entry
 - ❑ Logging onto Windows ([page 121](#))
If you have enrolled your fingerprints for your user account, you can substitute fingerprint authentication for password entry when logging onto Windows.
 - ❑ Power-on Security feature ([page 121](#))
If you have set the power-on password ([page 105](#)) and/or the hard disk password ([page 110](#)), you can substitute fingerprint authentication for password entry when starting your computer.
- ❑ Password bank for quick Web site access ([page 122](#))
You can substitute fingerprint authentication for entering information (user accounts, passwords, etc.) required to access the password-protected Web sites.
- ❑ File Safe feature to encrypt/decrypt data ([page 122](#))
With the File Safe feature, you can encrypt files and folder to create an encrypted archive. To decrypt or access such encrypted archives, you can use the fingerprint authentication or enter the password you specified for encryption.
- ❑ Application launcher function for quick application access ([page 122](#))
Once you have assigned an application to your finger, you can then swipe the finger across the fingerprint sensor to launch the assigned application.

Precautions on Using Fingerprint Authentication

- ❑ The fingerprint authentication technology does not assure complete user authentication or complete protection of your data and hardware.
Sony assumes no liabilities for any problems and damages arising out of your use of or inability to use the fingerprint sensor.
- ❑ The fingerprint recognition rate depends on your operating conditions and varies among individuals as well.
- ❑ Be sure to make a backup copy of the data stored on the hard disk drive, especially in the encrypted archives created with the File Safe feature, before sending your computer for repair.
Sony assumes no liabilities for any loss or modification of your data that might have occurred during the course of repair.
- ❑ In case the hard disk drive has to be initialized, for example after the repair work, the fingerprint templates will be lost. You will have to enroll them all over again.
- ❑ The maintenance and management of data concerning fingerprint authentication must be carried out at your own risk. Sony assumes no liabilities for any defects arising out of your data maintenance and management.
- ❑ Before disposing of your computer or transferring it to a third person, it is strongly recommended you erase the fingerprint data enrolled on the fingerprint sensor after erasing the data stored on your hard disk drive. See **Erasing the Enrolled Fingerprints (page 123)** for the detailed procedure.

Enrolling a Fingerprint

To use the fingerprint authentication functionality, you must enroll your fingerprint(s) in your computer.



Set the Windows password on your computer before enrollment. See **Adding the Windows Password (page 114)** for the detailed instructions.

To enroll a fingerprint



Up to 10 fingerprints can be enrolled for each user and up to 21 fingerprints can be enrolled for logging onto your system using the Power-on Security feature. You can also select the finger of which fingerprint you want to use for the Power-on Security feature later.

- 1 Click **Start, All Programs, Protector Suite QL, and Control Center**.
The **Fingerprint Control Center** window appears.
- 2 Click **Fingerprints** and **Initialize**.
- 3 Follow the on-screen instructions.



To read the detailed description, click **Help** in step 2.

If you have failed to enroll a fingerprint, follow these steps to try again.

- 1 Place the top joint of your finger on the fingerprint sensor (1).

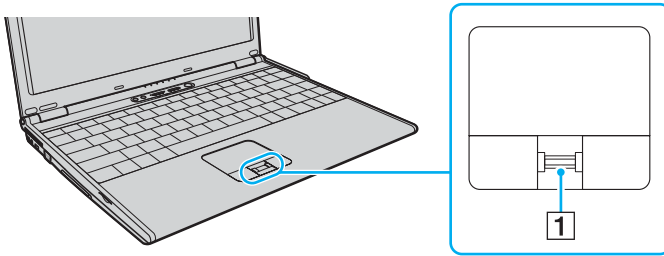

- 2 Swipe your finger perpendicularly across the fingerprint sensor.

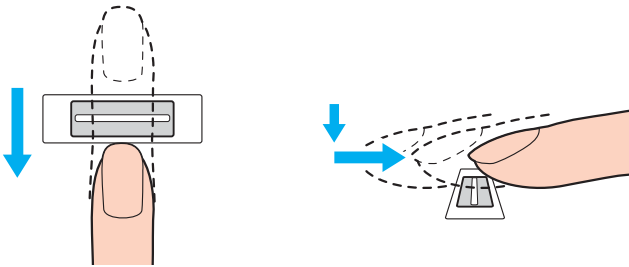

- ! Place your fingertip flat in the center of the fingerprint sensor.
- Scan your fingerprint from the top joint of the finger to the fingertip.
- Keep your finger in contact with the fingerprint sensor while swiping.
- Fingerprint enrollment may fail if you move your finger too fast or too slow. Let the fingerprint sensor take about one second to scan your fingerprint.
- You may not be able to enroll and/or recognize your fingerprint(s) if your finger is dry or wet, wrinkled, injured, dirty, etc.
- Enroll more than one fingerprint in case of inability to recognize the fingerprint.
- Up to 10 fingerprints can be enrolled per person. Note that up to 21 fingerprints can be enrolled for logging onto your system using the Power-on Security feature.
- Be sure to clean your fingertip(s) and the fingerprint sensor before swiping in order to keep good recognition performance.

Logging Onto Your System

To use the fingerprint authentication functionality in place of password entry to log onto your system, you need to set the power-on, hard disk, and Windows passwords and configure your computer for fingerprint authentication.

For setting the power-on, hard disk, and Windows passwords, see **Setting the Password (page 105)**.

Logging onto Windows

If you have set the Windows password, you can substitute fingerprint authentication for Windows password entry. To log onto Windows, swipe the finger with the enrolled fingerprint across the fingerprint sensor when the Windows log-on window appears.

For detailed information on logging onto Windows, click **Start, All Programs, Protector Suite QL**, and **Help** to read the help file.

Power-on Security feature

If you have set the power-on password ([page 105](#)) and/or the hard disk password ([page 110](#)), you can substitute fingerprint authentication for password entry when starting your computer.

For detailed information on the Power-on Security feature, click **Start, All Programs, Protector Suite QL**, and **Help** to read the help file.

Using the Password Bank

Once you have registered your user information (user accounts, passwords, etc.) for Web sites in the password bank, you can substitute fingerprint authentication for entering information required to access the password-protected Web sites.

For detailed information on using the password bank, click **Start, All Programs, Protector Suite QL**, and **Help** to read the help file.

! You may not be able to use the password bank feature depending on the Web site you access.

Using the File Safe Feature

With the File Safe feature, you can create an encrypted archive to include a file and/or folder for protection against unauthorized access. The encrypted archive can be decrypted or unlocked for included file/folder access by swiping your finger across the fingerprint sensor or entering the backup password you specified for encryption.

For detailed information on using the File Safe feature, click **Start, All Programs, Protector Suite QL**, and **Help** to read the help file.

Using the Application Launcher

The application launcher feature is available on your computer for launching your preferred application (executable file) that is assigned to one of your fingers with the enrolled fingerprint. Once you have assigned an application to your finger, you can launch the assigned application simply by swiping your finger across the fingerprint sensor.

For detailed information on using the application launcher feature, click **Start, All Programs, Protector Suite QL**, and **Help** to read the help file.

Using Fingerprint Authentication with the TPM

With the TPM data encryption feature, using fingerprint authentication can strengthen computer security. For instructions on how to use the TPM, see **Using Trusted Platform Module (TPM)** (page 124).

For detailed information on using fingerprint authentication with the TPM, click **Start, All Programs, Protector Suite QL, and Help** to read the help file.

Erasing the Enrolled Fingerprints

Before disposing of your computer or transferring it to a third person, it is strongly recommended you erase the fingerprint data enrolled on the fingerprint sensor after erasing the data stored on your hard disk drive.

To erase the enrolled fingerprints

- 1 Turn on the computer.
- 2 Press the **F2** key when the VAIO logo appears.
The BIOS setup screen appears. If not, restart the computer and press the **F2** key several times when the VAIO logo appears.
- 3 Press the **←** or **→** key to select **Security** to display the **Security** tab.
- 4 Press the **↓** key to select **Clear Fingerprint Data** and press the **Enter** key.
The fingerprint data enrolled on the fingerprint sensor is erased automatically after your system restarts.
- 5 At the confirmation prompt, select **Continue** and press the **Enter** key.

Using Trusted Platform Module (TPM)

The embedded Trusted Platform Module (TPM) provides your computer with basic security functions. In combination with the TPM, you can encrypt and decrypt your data to strengthen computer security against inappropriate access.

TPMs are defined by Trusted Computing Group (TCG) and also called security chips.

Precautions on Using the TPM

- ❑ Although your computer is provided with the latest TPM security functions, these functions do not assure complete protection of your data and hardware. Sony assumes no liabilities for any problems and damages arising out of your use of the functions.
- ❑ After you have installed the Infineon TPM Professional Package, you need to set a few TPM passwords on your computer. Without these passwords, you will not be able to restore any TPM-protected data. Be sure to write down the passwords and keep them safe and private from other people.
- ❑ Be sure to make backup copies of the latest emergency recovery archive file, emergency recovery token file, password reset token file, and personal secret file and keep them safe and private from other people before sending your computer for repair. The data stored in the TPM that is embedded on the motherboard may be lost or corrupted during the course of repair.
- ❑ During the course of repair, the TPM may be replaced even if there are no problems with the modules. In such a case, use the backup copies of the emergency recovery archive file, emergency recovery token file, password reset token file, and personal secret file to restore the TPM configuration.
- ❑ Be sure to make a backup copy of the data stored on the hard disk drive before sending your computer for repair. The hard disk drive may be initialized and returned after the repair work and, in such a case, you will not be able to restore the data on the hard disk drive using the backup copies of the emergency recovery archive file, emergency recovery token file, password reset token file, and personal secret file.

- ❑ Make sure you set up the automatic backup operations after completing the TPM initialization wizard. If the window containing the **Run automatic backup now** check box is displayed after the setup, select the check box and update the backup files. The restore process using the backup files may fail if you do not set up the automatic backup operations.
- ❑ The maintenance and management of TPM-protected data must be carried out at your own risk. Sony assumes no liabilities for any defects arising out of your data maintenance and management.

Important Notice

- ❑ Do not encrypt files containing keys to be used for encryption and folders including such files. Encrypting the files in the folders containing basic user keys and others, using the Encrypting File System (EFS) will disable you to launch your TPM software and decrypt the encrypted data in the following cases:
 - ❑ The TPM software has been installed.
 - ❑ The platform has been initialized.
 - ❑ The EFS functionality has been enabled in user initialization process.

With the default settings, the files in the folders below cannot be encrypted because they have system attributes. Do not change the system attributes of the files in the folders below.



The following folders are invisible by default.

- ❑ Folders containing basic user keys and others
 - C:\<username>\All Users\Infineon\TPM Software 2.0\BackupData
 - C:\<username>\All Users\Infineon\TPM Software 2.0\PlatformKeyData
 - C:\<username>\All Users\Infineon\TPM Software 2.0\RestoreData
 - (C:\<username>\All Users is a shortcut to C:\ProgramData.)
 - C:\<username>\<account>\AppData\Roaming\Infineon\TPM Software 2.0\UserKeyData

- ❑ Do not encrypt the following archive, backup, or token files. There will be no way to restore them if you carelessly encrypt them.
Sony assumes no liabilities for any troubles and damages arising out of your careless encryption of the following files and folders including them.
- ❑ Automatic backup file
 - Default file name: SPSystemBackup.xml
 - Default path: None (Clicking **Browse** displays the <userfolder>\Documents\Security Platform window.)
- ❑ Storage folder for automatic backup data
 - Default file name: SPSystemBackup
 - The folder is created as the subfolder for the SPSystemBackup.xml file.
- ❑ Token file for decryption
 - Default file name: SPemRecToken.xml
 - Default path: Removable media (FD, USB memory, etc.)
- ❑ Key and certificate backup file
 - Default file name: SpBackupArchive.xml
 - Default path: None (Clicking **Browse** displays the <userfolder>\Documents\Security Platform window.)
- ❑ PSD backup file
 - Default file name: SpPSDBackup.fsb
 - Default path: None (Clicking **Browse** displays the <userfolder>\Documents\Security Platform window.)

- ❑ Do not encrypt the following password reset token or secret files. There will be no way to reset the password if you carelessly encrypt them.
Sony assumes no liabilities for any troubles and damages arising out of your careless encryption of the following files and folders including them.
- ❑ Password reset token file
Default file name: SPPwdResetToken.xml
Default path: Removable media (FD, USB memory, etc.)
- ❑ Password reset secret file
Default file name: SPPwdResetSecret.xml
Default path: Removable media (FD, USB memory, etc.)

Configuring the TPM

To use the embedded TPM, you need to:

- 1 Enable the TPM on the BIOS setup screen.
- 2 Install the Infineon TPM Professional Package.
- 3 Initialize and configure the TPM.

To enable the TPM on the BIOS setup screen

- 1 Turn on your computer.
- 2 Press the **F2** key when the VAIO logo appears.
The BIOS setup screen appears. If not, restart the computer and press the **F2** key several times when the VAIO logo appears.
- 3 Press the **←** or **→** key to select **TPM State** and then select **Enabled** for **Change TPM State**.
- 4 Press the **←** or **→** key to select **Exit** and then **Exit Setup**; and press the **Enter** key.
- 5 After your system restarts, click **Execute** in the **Physical Presence Operations** window.

! Before enabling the TPM, be sure to set the power-on and hard disk passwords to protect against unauthorized modification of the TPM configuration. If the TPM is enabled, it will take longer before the VAIO logo appears due to security checks at computer startup.

 You can also disable the TPM and clear the TPM configuration on the BIOS setup screen. Note that you will not be able to access any TPM-protected data if you clear the TPM ownership. Before clearing the TPM configuration, be sure to make backup copies of the TPM-protected data.

To install the Infineon TPM Professional Package

Read the Readme.txt in the **C:\Infineon\Readme** folder. Then, double-click **C:\Infineon\setup.exe** to install the package.

To install this package, you must have administrator rights on the computer.

! You need to set a few passwords while installing Infineon TPM Professional Package. Without these passwords, you will not be able to restore any TPM-protected data or backup files. Be sure to write down the passwords and keep them safe and private from other people.

To initialize and configure the TPM

See the on-screen documentation for detailed information. To open the documentation, click **Start, All Programs, Infineon Security Platform Solution**, and **Help**.

! The maintenance and management of TPM-protected data must be carried out at your own risk. Sony assumes no liabilities for any defects arising out of your data maintenance and management.

Setting Up Your Computer with VAIO Central

The **VAIO Central** utility allows you to access system information and to specify preferences for system behavior.

To use VAIO Central

- 1 Click **Start, All Programs**, and **VAIO Central**.
The **VAIO Central** window appears.
- 2 Click the **Categories** tab.
- 3 Select the desired control item and change the settings.
- 4 Once finished, click **OK**.
The setting of the desired item has been changed.



Some of the control items will not be visible if you open **VAIO Central** as a standard user.

Using VAIO Status Monitor

The **VAIO Status Monitor** utility allows you to check various settings, such as the power management settings, security settings, and current usage of devices, in the **VAIO Status Monitor** window.

To display the VAIO Status Monitor window

- 1 Click **Start**, **All Programs**, and **VAIO Status Monitor**.
The **VAIO Status Monitor** window appears.



You can change the settings for certain items in the **VAIO Status Monitor** window. To change the settings, select the desired item and click **Settings**.

Using the Power Saving Modes

When you use a battery pack as the power source for your computer, you can take advantage of the power management settings to conserve battery life. In addition to the normal operating mode, which allows you to turn off specific devices, your computer has two distinct power saving modes: Sleep and Hibernate. When using battery power, you should be aware that the computer will automatically enter Hibernate mode if the remaining battery charge becomes short, regardless of the power management setting you select.



If the battery level falls below 10%, you should either connect the AC adapter to recharge the battery pack or shut down your computer and install a fully charged battery pack.

Using Normal Mode

This is the normal state of the computer when it is in use. The green power indicator light is on in this mode. To save power while not working, you can turn off a specific device such as the LCD screen or the hard disk drive.

Using Sleep Mode

Sleep mode turns off the LCD screen and places the storage device(s) and the CPU into a low power consumption mode. The amber power light flashes during this mode.



If you do not intend to use your computer for a long period of time while it is disconnected from AC power, place the computer into Hibernate mode or turn it off.

To activate Sleep mode

Click **Start**, the arrow next to the **Lock** button, and **Sleep**.



When your computer is in Sleep mode, you cannot insert a disc.

Your computer comes out of Sleep mode quicker than out of Hibernate mode.

Sleep mode uses more power than Hibernate mode.



If the battery runs down while your computer is in Sleep mode, you will lose any unsaved data. Going back to the previous work state is impossible. To avoid loss of data, you should save your data frequently.

To return to Normal mode

Press any key.



If you press and hold the power button for more than four seconds, your computer will turn off automatically. You will lose any unsaved data.



You can use **VAIO Central** to configure your computer to return to Normal mode when you open the LCD screen lid. This power resuming preference will be lost if you remove both the AC adapter and the battery pack. See **Setting Up Your Computer with VAIO Central (page 131)**.

If the computer is not used for a certain period of time, it will enter Sleep mode. To modify this, you can change the Sleep mode settings.

To change the Sleep mode settings

- 1 Right-click the power status icon on the taskbar and select **Power Options**.
- 2 Click **Change plan settings** under the current power plan.
- 3 Change the time to put the computer to sleep and click **Save Changes**.

Using Hibernate Mode

In Hibernate mode, the state of the system is saved on the hard disk drive and power is turned off. Even when the battery runs down, no data will be lost. The power indicator light is off in this mode.



If you do not intend to use your computer for a long period of time, place the computer into Hibernate mode. This power saving mode saves you the time of shutting down or resuming.

To activate Hibernate mode

Press the **Fn+F12** keys.

The computer enters Hibernate mode.

Alternatively, you can click **Start**, the arrow next to the **Lock** button, and **Hibernate** to place the computer into Hibernate mode.



When your computer is in Hibernate mode, you cannot insert a disc.

Hibernate mode requires more time than Sleep mode to be activated.

Hibernate mode uses less power than Sleep mode.



Do not move your computer before its power indicator light turns off.

To return to Normal mode

Press the power button.

The computer returns to its normal state.



If you press and hold the power button for more than four seconds, your computer will turn off automatically.



It takes more time to return to Normal mode from Hibernate mode than from Sleep mode.

You can use **VAIO Central** to configure your computer to return to Normal mode when you open the LCD screen lid. This power resuming preference will be lost if you remove both the AC adapter and the battery pack. See **Setting Up Your Computer with VAIO Central** ([page 131](#)).

Managing Power with VAIO Power Management

Power management helps you set up power schemes for running on AC power or batteries to suit your requirements for power consumption.

VAIO Power Management is a software application developed exclusively for VAIO computers. With this software application, you can enhance the Windows power management functions to ensure better operation of your computer and longer battery life. For more information on **VAIO Power Management**, see the help file on the **VAIO Power Management** software.

Activating VAIO Power Management

When you start the computer, a power status icon appears on the taskbar. This icon indicates what kind of power source you are using at that time, for example, AC power. Click this icon to display the window, showing your power status.

VAIO Power Management functionalities are added to the Windows **Power Options Properties**.

To activate VAIO Power Management

- 1 Right-click the power status icon on the taskbar and select **Power Options**.
- 2 Click **Change plan settings** under the current power plan.
- 3 Click **Change advanced power settings**.
The **Power Options** window appears.
- 4 Select the **VAIO Power Management** tab.

To restore the default settings

- 1 On the **VAIO Power Management** tab, click **Advanced**.
The **VAIO Power Management** window appears.
- 2 Follow the on-screen instructions to change the settings.

Activating VAIO Power Management Power Schemes

VAIO Power Management provides several predefined power schemes. Each power scheme consists of a group of power management settings that are designed to meet specific power management needs, ranging from maximum power management to no power management.

To activate a VAIO Power Management power scheme

- 1 Right-click the power status icon on the taskbar and select **Power Options**.
- 2 Select a power plan.
The power scheme has been activated.

If necessary, you can change advanced power settings. Follow these steps:

- 3 Click **Change plan settings** under the current power plan.
- 4 Click **Change advanced power settings**.
- 5 Select the **VAIO Power Management** tab.
You can change the items in the list.
- 6 Click **OK**.

VAIO Power Management Viewer

To start VAIO Power Management Viewer

Click  on the **VAIO Power Management** tab.

Alternatively, you can use **VAIO Central** to start **VAIO Power Management Viewer**. Double-click the **Power Management** folder on the **Categories** tab in the **VAIO Central** window, and then double-click the **VAIO Power Management Viewer** icon. For launching **VAIO Central**, see **Setting Up Your Computer with VAIO Central** ([page 131](#)).

To change the power scheme

Select the desired power scheme from the drop-down list on **VAIO Power Management Viewer**.

To view performance with the power scheme modified with VAIO Power Management

When both **VAIO Power Management** and **VAIO Power Management Viewer** are running, **VAIO Power Management Viewer** shows performance with the power scheme that was modified with **VAIO Power Management**.



Use **VAIO Power Management** to set up or modify the power scheme.

Protecting the Hard Disk

Your computer has the **VAIO HDD Protection** utility preinstalled for customizing your settings for protecting your hard disk drive against shock hazards. You can select the sensitivity level of the built-in shock sensor to set the appropriate protection level.

Activating VAIO HDD Protection

To protect your hard disk drive against shock hazards, you must first activate **VAIO HDD Protection**.

To activate VAIO HDD Protection

- 1 Click **Start, All Programs**, and **VAIO Central**.
- 2 Click **Security** on the **Categories** tab and double-click **Hard Disk Drive Protection Settings**.
The setup window appears.
- 3 Select the **Activate hard disk drive protection** check box.
- 4 Select one of the desired sensitivity level.
- 5 Click **OK**.
For more information, click **Help** on the setup window to open the help file.

! **VAIO HDD Protection** is designed to minimize possibilities of damage to hard disk drives and user data. It does not assure 100% data protection under any circumstances.

Hard disk drive protection is disabled before Windows launches and during a shift to Hibernate or Sleep mode, system recovery, and system shutdown.

Upgrading Your VAIO Computer

Your VAIO computer and memory modules use high precision components and electronic connectors technology. To avoid invalidation of the warranty during your product warranty period, we recommend that:

- You should contact your dealer to install a new memory module.
- You should not install it yourself, if you are not familiar with upgrading memory on a computer.
- You should not touch the connectors or open the memory module compartment cover.

For the type of module and the amount of memory installed on your model, see the online **Specifications**.

For assistance, contact an authorized Sony Service Center. To find the nearest center or agent, see **Sony Support Information** ([page 210](#)) or visit the Sony online support Web site.

Adding and Removing Memory

If you want to expand the functionality of your computer, you can increase the memory by installing optional memory modules. Before you upgrade your computer's memory, read the notes and procedures in the following pages.

Notes on adding/removing memory modules

- ❑ Be careful when changing memory. Improper installation of memory modules may cause damage to your system. This damage may void your manufacturer's warranty.
- ❑ Only use memory modules that are compatible with your computer. If a memory module is not detected by the computer or the Windows operating system becomes unstable, contact your sales dealer or the manufacturer of your memory module.
- ❑ Electrostatic discharge (ESD) can damage electronic components. Before touching a memory module, ensure the following:
 - ❑ The procedures described in this document assume user familiarity with the general terminology associated with personal computers and with the safety practice and regulatory compliance requirements for using and modifying electronic equipment.
 - ❑ Turn off your computer and disconnect it from its power source (that is, battery pack or AC adapter) and from any telecommunication links, networks, or modems before you remove any cover or panel from the computer. Failure to do so may result in personal injury or equipment damage.
 - ❑ ESD can damage memory modules and other components. Install the memory module only at an ESD workstation. If such a station is not available, do not work in a carpeted area, and do not handle materials that produce or hold static electricity (cellophane wrappers, for example). Ground yourself by maintaining contact with an unpainted metal portion of the chassis while performing the procedure.
 - ❑ Do not open the memory module package before you are ready to change the module. The package protects the module from ESD.

- Use the special bag delivered with the memory module or wrap the module in aluminum foil to protect it from ESD.
- Introducing any liquids, foreign substances, or objects into the memory module slots or other internal components of your computer will result in damage to the computer and any repair costs will not be covered by the warranty.
- Do not place the memory module in a location subject to:
 - Heat sources such as radiators or air ducts
 - Direct sunlight
 - Excessive dust
 - Mechanical vibration or shock
 - Strong magnets or speakers that are not magnetically shielded
 - Ambient temperature of more than 95°F (35°C) or less than 41°F (5°C)
 - High humidity
- Handle the memory module with care. To avoid injuries to your hands and fingers, do not touch the edges of the components and circuit boards inside your computer.

Removing and Installing a Memory Module

To change or add a memory module

- 1 Shut down the computer and disconnect all peripheral devices.
- 2 Unplug the computer and remove the battery pack.
- 3 Wait until the computer cools down.
- 4 Unscrew the screws (indicated by the arrows below) on the bottom of the computer and remove the memory module compartment cover.

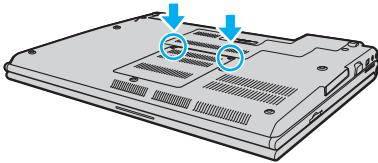

- 5 Touch a metal object to discharge static electricity.

- 6 Grasp the insulation sheet (1) tab and flip open the sheet.

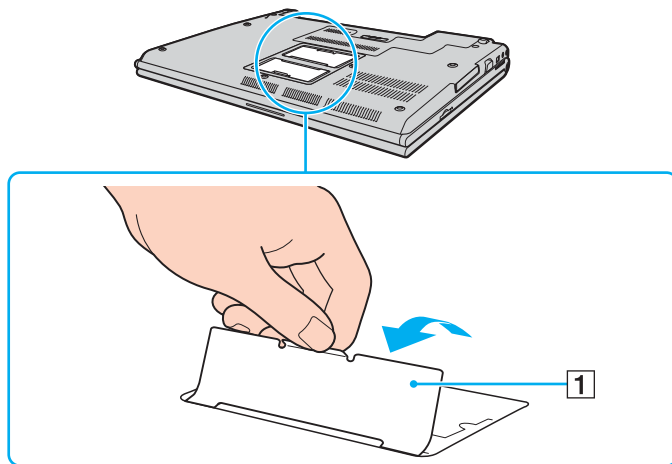

! The insulation sheet is equipped for module protection. Do not pull it so hard as to damage the sheet.

7 Remove the currently installed memory module as follows:

- ❑ Pull the latches in the direction of the arrows (1).
The memory module is released.
- ❑ Make sure that the memory module tilts up and then pull it out in the direction of the arrow (2).

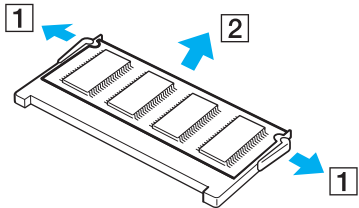

8 Remove the new memory module from its packaging.

- Slide the memory module into the memory module slot and push it in until it clicks into place.

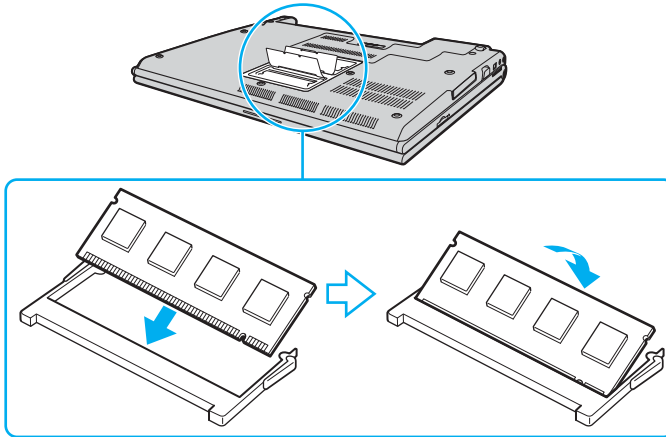

! Do not touch any other components on the motherboard.

Be sure to insert the connector edge of the memory module into the slot while aligning the notch on the module with the small projection in the open slot.

Do not damage the insulation sheet equipped for module protection.

- Replace the memory module compartment cover.
- Tighten the screws on the bottom of the computer.
- Reinstall the battery pack and turn on the computer.

Viewing the Amount of Memory

To view the amount of memory

- 1 Turn on the computer.
- 2 Click **Start**, **All Programs**, and **VAIO Central**.
The **VAIO Central** window appears.
- 3 Click the **Categories** tab.
- 4 Double-click the **System Information** folder.
- 5 Double-click the **System Information** icon.
You can view the amount of system memory. If the additional memory does not appear, repeat the whole installation procedure and restart the computer.

Precautions

This section describes safety guidelines and precautions to help you protect your VAIO computer from potential damage.

- ❑ **On Handling the LCD Screen** ([page 151](#))
- ❑ **On Using the Power Source** ([page 152](#))
- ❑ **On Handling Your Computer** ([page 153](#))
- ❑ **On Using the Built-in MOTION EYE Camera** ([page 155](#))
- ❑ **On Handling Floppy Disks** ([page 156](#))
- ❑ **On Handling Discs** ([page 157](#))
- ❑ **On Using the Battery Pack** ([page 158](#))
- ❑ **On Using Headphones** ([page 159](#))
- ❑ **On Handling Memory Stick Media** ([page 160](#))
- ❑ **On Handling the Hard Disk** ([page 161](#))
- ❑ **On Handling the Memory Card Adapter** ([page 162](#))
- ❑ **On Updating Your Computer** ([page 163](#))

On Handling the LCD Screen

- ❑ Do not leave the LCD screen facing the sun. This could damage the LCD screen. Be careful when using your computer near a window.
- ❑ Do not scratch the surface of the LCD screen or exert pressure on it. This could cause a malfunction.
- ❑ Using your computer in low temperature conditions may produce a residual image on the LCD screen. This is not a malfunction. When the computer returns to normal temperature, the screen returns to normal.
- ❑ A residual image may appear on the LCD screen if the same image is displayed for a long period of time. The residual image disappears in a while. You can use a screen saver to prevent residual images.
- ❑ The LCD screen becomes warm during operation. This is normal and does not indicate a malfunction.
- ❑ The LCD screen is manufactured using high-precision technology. You may, however, see tiny black points and/or bright points (red, blue, or green) that continuously appear on the LCD screen. This is a normal result of the manufacturing process and does not indicate a malfunction.
- ❑ Avoid rubbing the LCD screen. This could damage the screen. Use a soft, dry cloth to wipe the surface of the LCD screen.
- ❑ Do not change the LCD screen orientation setting in the **Tablet PC Settings** window even when there are change options available for selection, as it may make your computer unstable. Sony assumes no liabilities for any defects arising out of making the change.
- ❑ Do not exert pressure on the LCD screen lid with the lid closed as it may cause scratches on the LCD screen or soil it.

On Using the Power Source

- ❑ See the online **Specifications** to check the power operation of your model.
- ❑ Do not share the AC outlet with other power-consuming equipment, such as a photocopier or a shredder.
- ❑ You can purchase a power strip with a surge protector. This device helps prevent damage to your computer caused by sudden power surges, in an electrical storm, for example.
- ❑ Do not place heavy objects on the power cord.
- ❑ To disconnect the cord, pull it out by holding the plug. Never pull the cord itself.
- ❑ Unplug your computer from the AC outlet if you are not planning to use the computer for a long period of time.
- ❑ Make sure that the AC outlet is easily accessible.
- ❑ When the AC adapter is not used, unplug it from the AC outlet.
- ❑ Use the AC adapter supplied with your computer or genuine Sony products. Do not use any other AC adapter as it may cause a malfunction.

On Handling Your Computer

- ❑ Clean the cabinet with a soft cloth, which is dry or lightly moistened with a mild detergent solution. Do not use any type of abrasive pad, scouring powder, or solvent such as alcohol or benzene, as these may damage the finish of your computer.
- ❑ If you drop a solid object or any liquid onto your computer, shut down the computer and then unplug it. You may want to have the computer checked by qualified personnel before operating it again.
- ❑ Do not drop your computer or place any objects on top of the computer.
- ❑ Do not place your computer in a location subject to:
 - ❑ Heat sources, such as radiators or air ducts
 - ❑ Direct sunlight
 - ❑ Excessive dust
 - ❑ Moisture or rain
 - ❑ Mechanical vibration or shock
 - ❑ Strong magnets or speakers that are not magnetically shielded
 - ❑ Ambient temperature of more than 95°F (35°C) or less than 41°F (5°C)
 - ❑ High humidity
- ❑ Do not place electronic equipment near your computer. The electromagnetic field of the computer may cause a malfunction.
- ❑ Provide adequate air circulation to prevent internal overheating. Do not place your computer on porous surfaces such as rugs or blankets, or near material such as curtains or draperies that may block its air vents.
- ❑ Your computer uses high-frequency radio signals and may cause interference to radio or TV reception. If this occurs, relocate the computer a suitable distance away from the set.

- ❑ Use only specified peripheral equipment and interface cables; otherwise, problems may occur.
- ❑ Do not use cut or damaged connection cables.
- ❑ If your computer is brought directly from a cold location to a warm one, moisture may condense inside the computer. In this case, allow at least one hour before turning on the computer. If any problems occur, unplug the computer and contact an authorized Sony Service Center. To find the nearest center or agent, see **Sony Support Information (page 210)** or visit the Sony online support Web site.
- ❑ Make sure you disconnect the power cord before cleaning your computer.
- ❑ To avoid losing data if your computer is damaged, back up your data regularly.
- ❑ Do not exert pressure on the LCD screen or its edges when opening the LCD screen lid or lifting your computer. The LCD screen may be sensitive to pressure or added stress and exerting pressure may damage the screen or cause it to malfunction. To open the computer, hold the base with one hand and gently lift the LCD screen lid with the other. To carry the computer with the lid open, be sure to hold the computer with both hands.

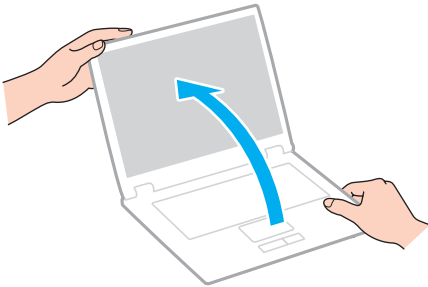

- ❑ Use a carrying case specially designed to carry your computer.

On Using the Built-in MOTION EYE Camera

- ❑ Do not touch the front mirror plate over the lens of the built-in **MOTION EYE** camera, as it may cause scratches on the plate and such scratches will appear on the captured images.
- ❑ Do not let the direct sunlight get into the scope of the built-in **MOTION EYE** camera regardless of your computer's power state, as it may cause a malfunction of the camera.
- ❑ The built-in **MOTION EYE** camera is disabled while videos or still images are imported from an i.LINK-compatible device connected to the i.LINK port.
- ❑ Clean the front mirror plate over the lens of the built-in **MOTION EYE** camera with a blower brush or a soft brush. If the lens is extremely dirty, wipe it off with a soft dry cloth. Do not rub the plate, as it is force-sensitive.

On Handling Floppy Disks

- ❑ Do not open the shutter manually or touch the surface of the floppy disk.
- ❑ Keep floppy disks away from magnets.
- ❑ Keep floppy disks away from direct sunlight and other sources of heat.
- ❑ Keep floppy disks away from any liquid. Do not let them get wet. When you are not using your floppy disk, always remove it from the floppy disk drive and use a storage case.
- ❑ If the floppy disk comes with an adhesive label, make sure that the label is properly affixed. If the edge of the label is curled up, the label may stick to the inside of the floppy disk drive and cause a malfunction or damage your floppy disk.

On Handling Discs

- ❑ Do not touch the surface of the disc.
- ❑ Do not drop or bend the disc.
- ❑ Fingerprints and dust on the surface of a disc may cause read errors. Always hold the disc by its edges and central hole, as shown below:

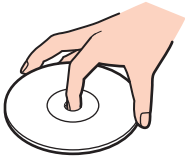

- ❑ Proper care of the disc is essential to its continuous reliability. Do not use solvents (such as benzene, thinner, alcohol, commercially available cleaners, or anti-static spray) which may cause damage to the disc.
- ❑ For normal cleaning, hold the disc by its edge and use a soft cloth to wipe the surface from the center out.
- ❑ If the disc is badly soiled, moisten a soft cloth with water, wring it out well, and use it to wipe the surface of the disc from the center out. Wipe off any remaining moisture with a dry soft cloth.
- ❑ Never affix an adhesive label to a disc. This will affect the use of the disc irreparably.

On Using the Battery Pack

- ❑ Do not leave battery packs in temperatures above 140°F (60°C), such as in a car parked in the sun or under direct sunlight.
- ❑ Battery life is shorter in a cold environment. This is due to decreased battery efficiency at low temperatures.
- ❑ Charge battery packs at temperatures between 50°F to 86°F (10°C to 30°C). Lower temperatures require longer charging time.
- ❑ This computer is designed to operate only with genuine Sony batteries.
- ❑ While the battery pack is in use or being charged, heat builds up in the battery pack. This is normal and is not cause for concern.
- ❑ Keep the battery pack away from all sources of heat.
- ❑ Keep the battery pack dry.
- ❑ Do not open or try to disassemble the battery pack.
- ❑ Do not expose the battery pack to any mechanical shock.
- ❑ If you are not using your computer for a long period of time, remove the battery pack from the computer to prevent damage to the battery pack.
- ❑ If, after fully charging the battery pack, the battery power is still low, the battery pack may be reaching the end of its life and should be replaced.
- ❑ You do not need to discharge the battery pack before recharging.
- ❑ If you have not used the battery pack for a considerable amount of time, recharge the battery pack.

On Using Headphones

- ❑ **Road safety** – Do not use headphones while driving, cycling, or operating any motorized vehicle. It may create a traffic hazard and is illegal in some areas. It can also be potentially dangerous to play loud music while walking, especially at pedestrian crossings.
- ❑ **Preventing hearing damage** – Avoid using headphones at high volume. Hearing experts advise against continuous, loud and extended play. If you experience a ringing in your ears, reduce the volume or discontinue use.

On Handling Memory Stick Media

- ❑ Do not touch the Memory Stick media connector with your finger or metallic objects.
- ❑ Use only the adhesive label supplied with the Memory Stick media as a label.
- ❑ Do not bend, drop, or apply strong shock to the Memory Stick media.
- ❑ Do not disassemble or modify Memory Stick media.
- ❑ Do not let Memory Stick media get wet.
- ❑ Do not use or store Memory Stick media in a location subject to:
 - ❑ Static electricity
 - ❑ Electrical noise
 - ❑ Extremely high temperatures, such as in a car parked in the sun
 - ❑ Direct sunlight
 - ❑ High humidity
 - ❑ Corrosive substances
- ❑ Use the storage case supplied with the Memory Stick media.
- ❑ Be sure to make a backup copy of your valuable data.
- ❑ Keep the Memory Stick media out of reach of children. There is a risk of swallowing the media.
- ❑ When using the Memory Stick Duo media, do not use a fine-tipped pen to write on the label adhered to the Memory Stick Duo media. Exerting pressure on the media may damage internal components.

On Handling the Hard Disk

The hard disk drive has a high storage density and reads or writes data in a short time. However, it can be easily damaged by mechanical vibration, shock, or dust.

Although the hard disk drive has the internal safety device to prevent losing data due to mechanical vibration, shock or dust, you should be careful when handling your computer.

- ❑ To avoid damaging your hard disk drive, observe the following:
 - ❑ Do not subject your computer to sudden movements.
 - ❑ Keep your computer away from magnets.
 - ❑ Do not place your computer in a location subject to mechanical vibration or in an unstable position.
 - ❑ Do not move your computer while the power is on.
 - ❑ Do not turn off the power or restart your computer while reading or writing data to the hard disk drive.
 - ❑ Do not use your computer in a place subject to extreme changes in temperature.



If the hard disk drive is damaged, the data cannot be restored.

- ❑ Your hard disk drive may start and stop spinning frequently and make a humming sound. However, this is normal and does not indicate a malfunction.

On Handling the Memory Card Adapter

- ❑ Do not touch the memory card adapter connector with your finger or metallic objects.
- ❑ Use only the adhesive label exclusively designed for the memory card adapter as a label.
- ❑ Do not bend, drop, or apply strong shock to the memory card adapter.
- ❑ Do not disassemble or modify the memory card adapter.
- ❑ Do not let the memory card adapter get wet.
- ❑ Do not use or store the memory card adapter in a location subject to:
 - ❑ Extremely high temperatures, such as in a car parked in the sun
 - ❑ Direct sunlight
 - ❑ High humidity
 - ❑ Corrosive substances
- ❑ Use the storage case supplied with the memory card adapter.

On Updating Your Computer

Confirm that the latest updates have been installed on your computer using the following software applications so that the computer can run more efficiently.

To confirm that they have been installed on the computer, follow these steps for each software application:

- ❑ **Windows Update**

Click **Start**, **All Programs**, and **Windows Update** and then follow the on-screen instructions.

- ❑ **VAIO Update 3**

Click **Start**, **All Programs**, **VAIO Update 3**, and **VAIO Update Options** and then follow the on-screen instructions.

If you have not yet installed the latest updates, install them with the above software. To download and install the updates on the computer, the computer must be connected to the Internet. For information on how to connect the computer to the Internet, see **Using the Internet** ([page 59](#)).

Troubleshooting

This section describes how to solve common problems you might encounter when using your VAIO computer. Many problems have simple solutions. Try these suggestions before visiting the Sony online support Web site at the following URLs:

<http://esupport.sony.com/EN/VAIO/> for customers in USA

<http://www.sony.ca/support> for customers in Canada

<http://esupport.sony.com/ES/VAIO/> for customers in Spanish speaking Latin American countries or areas

<http://esupport.sony.com/ES/VAIO/BR/> for customers in Brazil

- ❑ **Computer (page 166)**
- ❑ **System Security (page 173)**
- ❑ **Battery (page 174)**
- ❑ **Built-in MOTION EYE Camera (page 176)**
- ❑ **Internet (page 179)**
- ❑ **Networking (page 181)**
- ❑ **Bluetooth Technology (page 184)**
- ❑ **Optical Discs (page 188)**
- ❑ **Display (page 192)**
- ❑ **Printing (page 196)**
- ❑ **Microphone (page 197)**
- ❑ **Mouse (page 198)**
- ❑ **Speakers (page 199)**
- ❑ **Touch Pad (page 201)**
- ❑ **Keyboard (page 202)**

- ❑ **Floppy Disks** ([page 203](#))
- ❑ **PC Cards** ([page 204](#))
- ❑ **Audio/Video** ([page 206](#))
- ❑ **Memory Stick Media** ([page 207](#))
- ❑ **Peripherals** ([page 208](#))
- ❑ **Docking Station** ([page 209](#))

Computer

What should I do if my computer does not start?

- ❑ Make sure your computer is securely plugged into a power source and turned on. Make sure the power indicator shows the power is on.
- ❑ Make sure the battery pack is installed properly and charged.
- ❑ Make sure the floppy disk drive (if applicable) is empty.
- ❑ If your computer is plugged into a power strip or an uninterruptible power supply (UPS), make sure the power strip or UPS is plugged into a power source and turned on.
- ❑ If you are using an external display, make sure it is plugged into a power source and turned on. Make sure the brightness and contrast controls are adjusted correctly. See the manual that came with your display for more information.
- ❑ Disconnect the AC adapter and remove the battery pack. Wait three to five minutes. Reinstall the battery pack, reconnect the AC adapter, and then press the power button to turn on your computer.
- ❑ Condensation may cause your computer to malfunction. If this occurs, do not use the computer for at least one hour.
- ❑ Remove any extra memory modules you may have installed since purchase.
- ❑ Check that you are using the supplied Sony AC adapter. For your safety, use only the genuine Sony rechargeable battery pack and AC adapter, which are supplied by Sony for your VAIO computer.

What should I do if a BIOS error appears when I turn on my computer?

If the message "Press <F1> to resume, <F2> to setup" appears at the bottom of the screen, follow these steps:

- 1 Press the **F2** key.
The BIOS setup screen appears. If not, restart the computer and press the **F2** key several times when the VAIO logo appears.
- 2 Set the date (month/day/year). Press the **Enter** key.
- 3 Press the **↓** key to select **System Time**, and then set the time (hour: minute: second). Press the **Enter** key.
- 4 Press the **→** key to select the **Exit** tab, and then press the **F9** key.
At the confirmation prompt, press the **Enter** key.
- 5 Select **Exit Setup**, and press the **Enter** key.
At the confirmation prompt, press the **Enter** key.
Your computer restarts.

If this occurs frequently, contact an authorized Sony Service Center. To find the nearest center or agent, see **Sony Support Information** (page 210) or visit the Sony online support Web site.

What should I do if the power indicator (Green) lights but my screen stays blank?

Follow these steps:

- 1 Press and hold the power button for more than four seconds to check that the power indicator goes out. Then turn on your computer again.
- 2 If your computer screen still stays blank, unplug the AC adapter, remove the battery pack, and leave the computer for about a minute. Then reinstall the battery pack, plug in the AC adapter, and turn on the computer again.

What should I do if my computer or software stops responding?

- ❑ If your computer stops responding while a software application is running, press the **Alt+F4** keys to close the application window.
- ❑ If the **Alt+F4** keys do not work, click **Start**, the arrow next to the **Lock** button, and **Shut Down** to turn off your computer.
- ❑ If your computer does not turn off, press the **Ctrl+Alt+Delete** keys and click the arrow  next to the **Shut down** button and **Shut Down**.
If the **Windows Security** window appears, click **Shut Down**.

!
Turning off your computer with the **Ctrl+Alt+Delete** keys or the power button may cause loss of unsaved data.

- ❑ If your computer still does not turn off, press and hold the power button until the computer turns off.
- ❑ Remove the AC adapter and battery pack.
- ❑ Try reinstalling the software.
- ❑ Contact the software publisher or designated provider for technical support.

Why doesn't my computer enter Sleep or Hibernate mode?

Your computer may become unstable if the operating mode is changed before the computer completely enters Sleep or Hibernate mode.

To restore your computer to normal operating stability

- 1 Close all open programs.
- 2 Click **Start**, the arrow next to the **Lock** button, and **Restart**.
- 3 If your computer does not restart, press the **Ctrl+Alt+Delete** keys and click the arrow next to the **Shut down** button and **Restart**.
- 4 If this procedure does not work, press and hold the power button until the computer turns off.

! Turning off your computer with the power button may cause loss of unsaved data.

What should I do if the battery indicator is flashing and my computer does not start?

- ❑ This symptom could be due to the battery pack not being installed properly. To resolve this symptom, turn off your computer and remove the battery pack. Then install the battery pack to the computer again. For details, see **Installing the Battery Pack (page 21)**.
- ❑ If the symptom persists after performing the above, it means the installed battery pack is not compatible. Remove the battery pack and contact an authorized Sony Service Center. To find the nearest center or agent, see **Sony Support Information (page 210)** or visit the Sony online support Web site.

What should I do if a message window, notifying of incompatibility or improper installation of the battery pack, appears and my computer enters Hibernate mode?

- ❑ This symptom could be due to the battery pack not being installed properly. To resolve this symptom, turn off your computer and remove the battery pack. Then install the battery pack to the computer again. For details, see **Installing the Battery Pack (page 21)**.
- ❑ If the symptom persists after performing the above, it means the installed battery pack is not compatible. Remove the battery pack and contact an authorized Sony Service Center. To find the nearest center or agent, see **Sony Support Information (page 210)** or visit the Sony online support Web site.

Why does the System Properties window display a slower CPU speed than the maximum?

This is normal. Because your computer's CPU utilizes a type of CPU speed controlling technology for power conservation purposes, System Properties may display the CPU's current speed instead of the maximum speed.

What should I do if Windows does not start, showing a message, when I start my computer?

If you enter a wrong power-on password three times consecutively, the **Enter Onetime Password** message appears. If you enter a wrong power-on password three times consecutively again, the **System Disabled** message appears and Windows will not start. Press and hold the power button for more than four seconds to check that the power indicator goes off. Wait for 10 or 15 seconds, then restart your computer and enter the correct password. When entering the password, check that the Num lock indicator and Caps lock indicator are off. If any are lit, press the **Num Lk** key or the **Caps Lock** key to turn off the indicator before entering the password.

What should I do if my game software does not work or it keeps crashing?

- ❑ Check the Web site of the game if there are any patches or updates to download.
- ❑ Make sure you have installed the latest video driver.
- ❑ On some VAIO models, the graphics memory is shared with the system. The optimal graphic performance in this case is not guaranteed.

What should I do if I cannot remember the BIOS password?

If you have forgotten the BIOS password, contact an authorized Sony Service Center to reset it. A reset fee will be charged. To find the nearest center or agent, see **Sony Support Information (page 210)** or visit the Sony online support Web site.

Why does it take time before my computer starts?

- ❑ If Norton Internet Security's Personal Firewall is active, it may take some time before the desktop screen appears due to network security checkups.
- ❑ If the TPM is enabled, it will take longer before the VAIO logo appears due to security checks at computer startup.

Why doesn't my screen turn off when the time selected for the automatic turn-off action has passed?

The **VAIO Original Screen Saver** disables the timer setting, which you can select using the Windows power options, for your screen to turn off.

Select the screen saver other than the **VAIO Original Screen Saver**.

How can I change the boot device order?

You can use one of the BIOS functions to change the boot device order. Follow these steps:

- 1 Turn on your computer.
- 2 Press the **F2** key when the VAIO logo appears.
The BIOS setup screen appears. If not, restart the computer and press the **F2** key several times when the VAIO logo appears.
- 3 Press the **←** or **→** key to select **Boot**.
- 4 Press the **↑** or **↓** key to select the drive of which boot device order you want to change.
- 5 Press the **-** key or the **Shift + =** keys to change the boot device order.
Your computer will boot from the drive with the highest boot device order.
- 6 Press the **←** or **→** key to select **Exit**, select **Exit Setup**, and then press the **Enter** key.
At the confirmation prompt, press the **Enter** key.

What should I do if I cannot boot my computer from the USB floppy disk drive connected to the computer?

To boot your computer from the USB floppy disk drive, you need to change the boot device.

Turn on your computer and press the **F11** key when the VAIO logo appears.

System Security

How can I protect my computer against security threats, such as viruses?

The Microsoft Windows operating system is preinstalled on your computer. The best way to protect your computer against security threats, such as viruses, is to download and install the latest Windows updates regularly.

You can get important Windows updates by doing the following:



Your computer must be connected to the Internet before you can receive updates.

- 1 Connect to the Internet.
- 2 Double-click the **Windows Security Alerts** icon on the taskbar.
- 3 Follow the on-screen instructions to set up automatic or scheduled updates.

How do I keep my antivirus software updated?

You can keep the **Norton Internet Security** software program current with the latest updates from Symantec Corporation.

To download and install the latest security update

- 1 Click **Start, All Programs, Norton Internet Security, and Norton Internet Security**.
- 2 Click the item to update the software on the left pane.
- 3 Follow the on-screen instructions to select and download updates.

Battery

How do I find the battery charging status?

See **Charging the Battery Pack** ([page 23](#)).

When is my computer using AC power?

When your computer is directly connected to the AC adapter, it uses AC power, even if the battery pack is installed.

When should I recharge the battery pack?

- When the battery level falls below 10%.
- When both the battery and power indicators blink.
- When you have not used the battery pack for a long period of time.

When should I replace the battery pack?

If the battery power is still low after charging it, the battery pack may be reaching the end of its life and should be replaced.

Should I be concerned that the installed battery pack is warm?

No, it is normal for the battery pack to be warm when it is powering your computer.

Can my computer enter Hibernate mode while using battery power?

Your computer can enter Hibernate mode while using battery power, but some software programs and peripheral devices prevent the system from entering Hibernate mode. If you are using a program that prevents the system from entering Hibernate mode, save your data frequently to avoid losing data. See **Using Hibernate Mode (page 136)** for information on how you can manually activate Hibernate mode.

Built-in MOTION EYE Camera

Why does the viewer window show no images or poor-quality images?

- The built-in **MOTION EYE** camera cannot be shared by more than one software application. If another software application is using the camera, exit the application before using the built-in **MOTION EYE** camera.
- The video memory of your computer may have become insufficient for displaying images from the built-in **MOTION EYE** camera. Lowering the resolution or reducing the colors of the LCD screen might help.
- The viewer window may show some noises, for example horizontal streaks, if you view a rapid-moving object. This is normal and does not indicate a malfunction.
- If the problem persists, restart your computer.

Why are captured images poor in quality?

- The images captured under the fluorescent lamp may show reflection of the light.
- A dark portion in captured images may appear as a noise.
- If the front mirror plate over the lens is dirty, you cannot take a clear shot. Clean the lens. See **On Using the Built-in MOTION EYE Camera** (page 155).

Why do captured images contain dropped frames and audio interruptions?

- The effect settings on your software application may have caused dropped frames. See the help file on your software application for more information.
- There may be more software applications running than your computer can handle. Exit the applications that you are not currently using.
- The power management function of your computer may have been activated. Check the CPU performance.

Why does movie playback show dropped frames when my computer is running on the battery?

The battery pack is running out of power. Connect your computer to an AC power source.

Why do the images captured by the built-in MOTION EYE camera flicker?

This problem occurs when you use the camera under fluorescent lights due to the mismatch between lighting output frequency and shutter speed.

To reduce flicker noise, change the pointing direction of the camera or the brightness of camera images. In some software applications, you can set an appropriate value to one of the camera properties (e.g. **LightSource**, **Flickness**, etc.) to eliminate flicker noise.

Why is the video input from the built-in MOTION EYE camera suspended for a few seconds?

The video input may be suspended for a few seconds if:

- a shortcut key with the **Fn** key is used.
- the CPU load increases.

This is normal and does not indicate a malfunction.

Why can't I use the built-in MOTION EYE camera?

- ❑ The built-in **MOTION EYE** camera cannot be shared by more than one software application. If another software application is using the camera, exit the application before using the built-in **MOTION EYE** camera.
- ❑ If the problem persists, you must reinstall the driver software for the camera. Follow these steps:
 - 1 Click **Start, Control Panel, Hardware and Sound,** and **Device Manager.**
 - 2 Double-click **Imaging devices.**
 - 3 Right-click the device name for your camera and click **Update Driver Software.**

What should I do if my computer becomes unstable when it enters a power saving mode while the built-in MOTION EYE camera is in use?

- ❑ Do not place your computer into Sleep or Hibernate mode while you are using the built-in **MOTION EYE** camera.
- ❑ If your computer automatically enters Sleep or Hibernate mode, change the corresponding power saving mode setting. For changing the setting, see **Using the Power Saving Modes (page 133).**

What should I do if I cannot successfully capture videos in the WMV format with the built-in MOTION EYE camera?

Change the record format to the MPEG-1 format, or click the **VAIO Camera Utility** icon on the taskbar and the **Advanced Settings** button and cancel the **Low Light** check box on the **Properties** window.

Internet

What should I do if my modem does not work?

- Make sure the telephone cable is securely plugged into the modem port on your computer and the wall jack.
- Make sure the telephone cable is working. Plug the cable into an ordinary telephone and listen for a dial tone.
- Make sure that the telephone number the program is dialing is correct.
- Make sure the software you are using is compatible with your computer's modem. (All preinstalled Sony programs are compatible.)
- Make sure the modem is the only device connected to your telephone line.
- Follow these steps to check the settings:
 - 1 Click **Start** and **Control Panel**.
 - 2 Click **Hardware and Sound**.
 - 3 Click **Phone and Modem Options**.
 - 4 On the **Modems** tab, check that your modem is listed.
 - 5 On the **Dialing Rules** tab, check the location information is correct.

Why is my modem connection slow?

Your computer is equipped with a V.92/ V.90 compatible modem. Many factors may influence modem connection speed, including telephone line noise or compatibility with telephone equipment, such as fax machines or other modems. If you think your modem is not connecting properly to other PC-based modems, fax machines, or your Internet Service Provider (ISP), do any of the following:

- Ask your telephone company to verify your telephone line is free of any line noise.
- If your problem is fax-related, make sure there are no problems with the fax machine you are calling and that it is compatible with fax modems.
- If you are having a problem connecting with your ISP, make sure the ISP is not experiencing technical problems.
- If you have a second telephone line, try connecting the modem to that line.

Networking

What should I do if my computer cannot connect to a wireless LAN access point?

- Connection availability is affected by distance and obstructions. You may need to move your computer away from obstructions or closer to any access point you may be using.
- Make sure the **WIRELESS** or **WIRELESS LAN** switch is on and the Wireless LAN indicator is lit on your computer.
- Make sure power to the access point is on.
- Follow these steps to check the settings:
 - 1 Click **Start** and **Control Panel**.
 - 2 Click **View network status and tasks** under **Network and Internet**.
 - 3 Click **Connect to a network** to confirm that your access point is selected.
- Make sure the encryption key is correct.
- Make sure **Maximum Performance** is selected for **Wireless Adapter Settings** in the **Power Options** window. Selecting any other option may result in a communication failure. To change the settings, follow these steps:
 - 1 Right-click the power status icon on the taskbar and select **Power Options**.
 - 2 Click **Change plan settings** under the current power plan.
 - 3 Click **Change advanced power settings**.
The **Power Options** window appears.
 - 4 Select the **Advanced settings** tab.
 - 5 Double-click **Wireless Adapter Settings** and **Power Saving Mode**.
 - 6 Select **Maximum Performance** from the drop-down list both for **On battery** and **Plugged in**.

What should I do if I cannot access the Internet?

- ❑ Check the access point settings. See the manual that came with your access point for more information.
- ❑ Make sure your computer and the access point are connected to one another.
- ❑ Move your computer away from obstructions or closer to any access point you may be using.
- ❑ Make sure your computer is properly configured for Internet access.
- ❑ Make sure **Maximum Performance** is selected for **Wireless Adapter Settings** in the **Power Options** window. Selecting any other option may result in a communication failure. Follow the steps in **What should I do if my computer cannot connect to a wireless LAN access point? (page 181)** to change the settings.

Why is the data transfer speed slow?

- ❑ The wireless LAN data transfer speed is affected by distance and obstructions between devices and access points. Other factors include device configurations, radio conditions, and software compatibility. To maximize the data transfer speed, move your computer away from obstructions or closer to any access point you may be using.
- ❑ If you are using a wireless LAN access point, the device may be temporarily overloaded depending on how many other devices are communicating via the access point.
- ❑ If your access point interferes with other access points, change the access point channel. See the manual that came with your access point for more information.
- ❑ Make sure **Maximum Performance** is selected for **Wireless Adapter Settings** in the **Power Options** window. Selecting any other option may result in a communication failure. Follow the steps in **What should I do if my computer cannot connect to a wireless LAN access point? (page 181)** to change the settings.

How do I avoid data transfer interruptions?

- ❑ When your computer is connected to an access point, data transfer interruptions may occur when using large files or if the computer is in close proximity to microwaves and cordless telephones.
- ❑ Move your computer closer to the access point.
- ❑ Make sure the access point connection is intact.
- ❑ Change the access point channel. See the manual that came with your access point for more information.
- ❑ Make sure **Maximum Performance** is selected for **Wireless Adapter Settings** in the **Power Options** window. Selecting any other option may result in a communication failure. Follow the steps in **What should I do if my computer cannot connect to a wireless LAN access point? (page 181)** to change the settings.

What are channels?

- ❑ Wireless LAN communication occurs on divided frequency bands known as channels. Third-party wireless LAN access point channels may be preset to different channels from Sony devices.
- ❑ If you are using a wireless LAN access point, see connectivity information contained in the manual that came with your access point.

Why does the network connection stop when I change the encryption key?

Two computers with the wireless LAN functionality may lose a peer-to-peer network connection if the encryption key is changed. You can either change the encryption key back to the original profile or re-enter the key on both computers so the key matches.

Bluetooth Technology

What should I do if other Bluetooth devices cannot discover my computer?

- Make sure both devices have the Bluetooth functionality enabled.
- If the Bluetooth indicator is off, turn on the **WIRELESS** switch.
- You cannot use the Bluetooth functionality when your computer is in a power saving mode. Return to Normal mode, then turn on the **WIRELESS** switch.
- Your computer and the device may be too far apart. Wireless Bluetooth technology works best when the devices are within 33 feet (10 meters) of each other.

Why can't my computer discover other Bluetooth devices?

If the connected device is also connected to other devices, it may not appear in the Bluetooth utility software or you may not be able to communicate with the device.

What should I do if I cannot find the Bluetooth device with which I want to communicate?

- Check that the Bluetooth functionality of the device with which you want to communicate is on. See the other device's manual for more information.
- If the device with which you want to communicate is already communicating with another Bluetooth device, it may not be found or it may not be able to communicate with your computer.
- To allow other Bluetooth devices to communicate with your computer, right-click the Bluetooth icon  on the taskbar and select **Options** from the menu to open the **Options** window. Then, check if proper security modes are selected on the **Security** tab. For details on the security modes, see the help file on the Bluetooth utility software. See **Communicating with Another Bluetooth Device (page 70)** for more information.

What should I do if other Bluetooth devices cannot connect to my computer?

- ❑ Make sure the other device is authenticated.
- ❑ Your computer may not allow connections from other devices. To enable Bluetooth device connections, follow these steps:
 - 1 Right-click the Bluetooth icon  on the taskbar.
 - 2 Select **Options** from the menu.
The **Options** window appears.
 - 3 Check if **Standard** or **Low** is selected for the Bluetooth security level on the **Security** tab.
If a custom Bluetooth security level is selected, click the **Default level** button.
 - 4 Click **OK**.
- ❑ The data transfer distance can be shorter than 33 feet (10 meters) depending on existing obstacles between the two devices, on radio wave quality, and on the operating system or the software in use. Move your computer and Bluetooth devices closer to each other.
- ❑ If the device with which you want to communicate is already communicating with another Bluetooth device, it may not be found or it may not be able to communicate with your computer.
- ❑ Check that the Bluetooth functionality of the device with which you want to communicate is on. See the other device's manual for more information.

Why is my Bluetooth connection slow?

- ❑ The data transfer speed depends on the obstacles and/or the distance between the two devices, on the radio wave quality, and on the operating system or the software in use. Move your computer and Bluetooth devices closer to each other.
- ❑ The 2.4 GHz radio frequency used by Bluetooth and wireless LAN devices is also used by other devices. Bluetooth devices incorporate technology that minimizes interference from other devices using the same wavelength, however, communication speed and connection range may be reduced. Interference from other devices may also stop communication altogether.
- ❑ Connection availability is affected by distance and obstructions. You may need to move your computer away from obstructions or closer to the device to which it is connected.
- ❑ Identify and remove obstacles between your computer and the device to which it is connected.
- ❑ Note that due to limitations of the Bluetooth standard, large files may occasionally be corrupted during continuous transfer due to electromagnetic interference from the environment.

Why can't I connect to service supported by the target Bluetooth device?

Connection is only possible for services also supported by the computer with the Bluetooth functionality. For more details, see the help file on the Bluetooth utility software.

Can I use a device with Bluetooth technology on airplanes?

With Bluetooth technology, your computer transmits a radio frequency of 2.4 GHz. Sensitive locations, such as hospitals and airplanes, may have restrictions on use of Bluetooth devices, due to radio interference. Check with facility staff to see if use of the Bluetooth functionality on the computer is permitted.

Why can't I connect to a Bluetooth device by specifying its IP address on a Personal Area Network (PAN)?

The Bluetooth utility software uses Dynamic Host Configuration Protocol (DHCP) to assign IP addresses to active wireless devices. If you specify a fixed IP address for the device to which you want to connect, the utility cannot assign a dynamic IP address to the device and fails. Do not specify IP addresses when using a PAN.

Why can't I use the Bluetooth functionality when I log onto my computer as a user with a standard user account?

The Bluetooth functionality may not be available to a user with a standard user account on your computer. Log onto the computer as a user with administrator rights.

Why can't I connect to a Bluetooth device in Personal Area Network User mode?

If the device to which you want to connect supports Bluetooth communication in Personal Area Network User mode only, you cannot establish a connection from your computer.

Why can't I use the Bluetooth utility software when I switch a user?

If you switch a user without logging off your system, the Bluetooth utility software will not work successfully. Be sure to log off before switching a user. To log off your system, click **Start**, the arrow next to the **Lock** button, and **Log Off**.

Optical Discs

Why does my computer freeze when I try to read a disc?

The disc that your computer is trying to read may be dirty or damaged. Follow these steps:

- 1 Press the **Ctrl+Alt+Delete** keys and click the arrow next to the **Shut down** button and **Restart** to restart the computer.
- 2 Remove the disc from the optical disc drive.
- 3 Check the disc for dirt or damage. If you need to clean the disc, see **On Handling Discs (page 157)** for instructions.

What should I do if the drive tray does not open?

- Make sure your computer is on.
- Press the drive eject button.
- If the drive eject button does not work, click **Start** and **Computer**. Right-click the optical disc drive icon, and select **Eject** from the shortcut menu.
- If none of the above options work, insert a thin, straight object (such as a paper clip) in the manual eject hole on the optical disc drive.
- Try restarting your computer.

What should I do if I cannot play a disc properly on my computer?

- ❑ Make sure the disc is inserted into the optical disc drive with the label facing upward.
- ❑ Make sure the necessary program(s) is installed according to the manufacturer's instructions.
- ❑ If a disc is dirty or damaged, your computer will stop responding. Follow these steps:
 - 1 Press the **Ctrl+Alt+Delete** keys and click the arrow next to the **Shut down** button and **Restart** to restart the computer.
 - 2 Remove the disc from the optical disc drive.
 - 3 Check the disc for dirt or damage. If you need to clean the disc, see **On Handling Discs (page 157)** for instructions.
- ❑ If you are playing a disc and cannot hear sound, do any of the following:
 - ❑ Check if the volume is turned off or minimized by the **Fn+F2** or **Fn+F3** buttons, respectively.
 - ❑ Right-click the volume icon on the taskbar and click **Open Volume Mixer** to check the settings.
 - ❑ Check the volume setting in the audio mixer.
 - ❑ If you are using external speakers, check the volume settings on the speakers and the connections between the speakers and your computer.
 - ❑ Make sure the correct driver software is installed. Follow these steps:
 - 1 Click **Start** and **Control Panel**.
 - 2 Click **System and Maintenance**.
 - 3 Click **System**.
 - 4 Click **Device Manager** on the left pane.

The **Device Manager** window appears with a listing of your computer's hardware devices.
If an "X" or an exclamation point appears on the listed device, you may need to enable the device or reinstall the drivers.

- 5 Double-click the optical disc drive device to open a list of the optical disc drives of your computer.
 - 6 Double-click the desired drive.
You can confirm the driver software by selecting the **Driver** tab, and clicking **Driver Details**.
 - 7 Click **OK** to close the window.
- Make sure an adhesive label is not affixed to a disc. Adhesive labels can come off while the disc is in the optical disc drive and damage the drive or cause it to malfunction.
 - If a region code warning appears, the disc may be incompatible with the optical disc drive. Check the DVD package to make sure the region code is compatible with the optical disc drive.
 - If you notice condensation on your computer, do not use the computer for at least one hour. Condensation can cause the computer to malfunction.
 - Make sure your computer is running on AC power supply and try the disc again.

What should I do if I cannot write data to CD media?

- ❑ Make sure you neither launch any software application nor allow any to launch automatically, not even a screen saver.
- ❑ Stop using the keyboard.
- ❑ If you are using a CD-R/RW disc with an adhesive label affixed, replace it with one with no affixed adhesive label. Using a disc with an affixed adhesive label could cause a write error or other damage.

What should I do if I cannot write data to DVD media?

- ❑ Make sure you are using the correct DVD recordable media.
- ❑ Check which DVD recordable format is compatible with your optical disc drive. Note the possibility that some brands of DVD recordable media do not work.

Display

Why did my screen go blank?

- ❑ Your computer screen may go blank if the computer loses power or enters a power saving mode (Sleep or Hibernate). If the computer is in LCD (Video) Sleep mode, press any key to bring the computer back into Normal mode. See **Using the Power Saving Modes (page 133)** for more information.
- ❑ Make sure your computer is securely plugged into a power source and turned on. Make sure the power indicator shows the power is on.
- ❑ If your computer is using battery power, make sure the battery pack is installed properly and is charged. See **Using the Battery Pack (page 21)** for more information.
- ❑ If the display mode is set to the external display, press the **Fn+F7** keys. See **Combinations and Functions with the Fn Key (page 29)** for more information.

Why doesn't my screen display a video?

- ❑ If the external display is selected for the display output and the external display is disconnected, you cannot display a video on your computer screen. Stop video playback, change the display output to the computer screen, and then restart video playback. See **Selecting Display Modes (page 89)**. Alternatively, you can press the **Fn+F7** keys to change the display output. See **Combinations and Functions with the Fn Key (page 29)** for more information.
- ❑ The video memory of your computer may be insufficient for displaying high resolution videos. In this case, lower the resolution of the LCD screen.

To change the screen resolution, follow these steps:

- 1 Right-click the desktop and select **Personalize** from the shortcut menu.
- 2 Click **Display Settings**.
The **Display Settings** window appears.
- 3 Move the slider under **Resolution** to the left to reduce or to the right to increase the screen resolution.



You can confirm the value of the total available graphics memory and video memory. Right-click on the desktop, select **Personalize** from the shortcut menu, and click **Display Settings**, **Advanced Settings**, and the **Adaptor** tab. The value may be displayed differently from the actual memory on your computer.

What should I do if my screen is dark?

Press the **Fn+F6** keys to brighten your computer screen.

What should I do if the LCD brightness of my screen changes?

The LCD brightness setting, adjusted with the **Fn+F5/F6** keys, is temporary and may be restored to the original setting when your computer returns to Normal mode from Sleep or Hibernate mode. To save your preference for the brightness, follow these steps:

- 1 Right-click the power status icon on the taskbar and select **Power Options**.
- 2 Click **Change plan settings** under the current power plan.
- 3 Click **Change advanced power settings**.
The **Power Options** window appears.
- 4 Select the **Advanced settings** tab.
- 5 Double-click **Display**.
- 6 Adjust the LCD brightness setting in the item for brightness adjustment.

What should I do if the external display stays blank?

If you cannot change the display output with the **Fn+F7** keys, you need to change the settings for the external display with **VAIO Central**. To change the settings, launch the **VAIO Central**, click the **Categories** tab and select the control item for the external display, and then click to select the check box for changing the options to detect the external display. Then, try the **Fn+F7** keys to change the display output.

How do I run Windows Aero?



This Q & A entry applies to selected models only.

To run Windows Aero, follow these steps:

- 1 Click **Start** and **Control Panel**.
- 2 Click **Customize colors** under **Appearance and Personalization**.
- 3 Click **Open classic appearance properties for more color options**.
The **Appearance Settings** window appears.
- 4 Select **Windows Aero** from the **Color scheme** options on the **Appearance** tab.
- 5 Click **OK**.

For information about the Windows Aero features, such as Windows Flip 3D, see **Windows Help and Support**.

Printing

What should I do if I cannot print a document?

- ❑ Make sure your printer is on, and the printer cable is securely connected to the ports on the printer and computer.
- ❑ Make sure your printer is compatible with the Windows operating system installed on your computer.
- ❑ You may need to install the printer driver software before you use your printer. See the manual that came with your printer for more information.
- ❑ If your printer is not functioning after your computer resumes from a power saving mode (Sleep or Hibernate), then restart the computer.
- ❑ If the bidirectional communication functions are provided with your printer, disabling the functions on your computer may enable printing. Follow these steps:
 - 1 Click **Start** and **Control Panel**.
 - 2 Click **Printer** under **Hardware and Sound**.
 - 3 Right-click the printer icon and select **Properties**.
 - 4 Click the **Ports** tab.
 - 5 Click to cancel the **Enable bidirectional support** check box.
 - 6 Click **OK**.

This change to the settings disables the bidirectional communication functions of the printer, such as data transfer, status monitoring, and remote panel.

When your printer is connected to the docking station, check the docking station to see if it is connected to an AC power source.

Microphone

What should I do if my microphone does not work?

If you are using an external microphone, make sure the microphone is turned on and is properly plugged into the microphone jack on your computer.

How can I prevent microphone feedback?

Microphone feedback occurs when the microphone receives the sound from a sound output device, such as a speaker.

To prevent this problem:

- Keep the microphone away from a sound output device.
- Turn down the volume of the speakers and the microphone.

Mouse

What should I do if my computer does not recognize my mouse?

- Make sure your mouse is securely plugged into the port.
- Restart your computer with your mouse connected.

What should I do if the pointer does not move when I use my mouse?

- Make sure another mouse is not connected.
- If the pointer does not move while a software application is running, press the **Alt+F4** keys to close the application window.
- If the **Alt+F4** keys do not work, click **Start**, the arrow next to the **Lock** button, and **Restart** to restart your computer.
- If your computer does not restart, press the **Ctrl+Alt+Delete** keys and click the arrow next to the **Shut down** button and **Restart**.
If the **Windows Security** window appears, click **Restart**.
- If this procedure does not work, press and hold the power button until the computer turns off.

! Turning off your computer with the power button may cause loss of unsaved data.

Speakers

What should I do if my external speakers do not work?

- ❑ If you are using a program that has its own volume control, make sure the volume control is properly set. See the program's help file for more information.
- ❑ Make sure your speakers are properly connected and the volume is turned up loud enough to hear sound.
- ❑ Make sure your speakers are designed for computer use.
- ❑ If your speakers have a muting button, set the button to off.
- ❑ The volume may have been turned off by the **Fn+F2** keys. Press them once again.
- ❑ The volume may have been minimized by the **Fn+F3** keys. Press the **Fn+F4** keys to turn up the volume loud enough to hear sound.
- ❑ If your speakers require external power, make sure the speakers are connected to a power source. See the manual that came with your speakers for more information.
- ❑ Check the Windows volume controls by clicking the volume icon on the taskbar.

What should I do if I do not hear sound from the built-in speakers?

- ❑ If you are using a program that has its own volume control, make sure the volume control is properly set. See the program's help file for more information.
- ❑ Make sure the speaker volume is turned up loud enough and the audio option is enabled.
- ❑ The volume may have been turned off by the **Fn+F2** keys. Press them once again.
- ❑ The volume may have been minimized by the **Fn+F3** keys. Press the **Fn+F4** keys to turn up the volume loud enough to hear sound.
- ❑ Check the Windows volume controls by clicking the volume icon on the taskbar.
- ❑ If **Audio/Modem** is disabled on **VAIO Power Management** power scheme settings, enable the option. See **Activating VAIO Power Management Power Schemes (page 139)** for the procedure.

Touch Pad

What should I do if the touch pad does not work?

- ❑ You may have disabled the touch pad without connecting a mouse to your computer.
- ❑ Make sure that a mouse is not connected to your computer.
- ❑ If the pointer does not move while a software application is running, press the **Alt+F4** keys to close the application window.
- ❑ If the **Alt+F4** keys do not work, click **Start**, the arrow next to the **Lock** button, and **Restart** to restart your computer.
- ❑ If your computer does not restart, press the **Ctrl+Alt+Delete** keys and click the arrow next to the **Shut down** button and **Restart**.
If the **Windows Security** window appears, click **Restart**.
- ❑ If this procedure does not work, press and hold the power button until the computer turns off.



Turning off your computer with the power button may cause loss of unsaved data.

Keyboard

What should I do if the keyboard configuration is wrong?

The language layout of your computer's keyboard is labeled on the packaging box. If you choose a different regional keyboard when you complete the Windows setup, the key configuration will be mismatched.

To change the keyboard configuration, follow these steps:

- 1 Click **Start** and **Control Panel**
- 2 Click **Clock, Language, and Region**, and click **Regional and Language Options**.
- 3 Change the settings as desired.

What should I do if I cannot enter certain characters with the keyboard?

If you cannot enter **U, I, O, P, J, K, L, M**, and so on, the **Num Lk** key may be activated. Check that the Num lock indicator is off. If the Num lock indicator is on, press the **Num Lk** key to turn it off before entering these characters.

Floppy Disks

Why doesn't the Safely Remove Hardware icon appear on the taskbar when the drive is connected?

Your computer does not recognize the floppy disk drive. First, make sure the USB cable is properly connected to the USB port. If you need to secure the connection, wait a few moments for the computer to recognize the drive. If the icon still does not appear, follow these steps:

- 1 Close all programs that are accessing the floppy disk drive.
- 2 Wait for the LED indicator on the floppy disk drive to turn off.
- 3 Push the eject button to remove the disk, and disconnect the USB floppy disk drive from your computer.
- 4 Reconnect the floppy disk drive by inserting the USB connector (with the USB icon facing upward) into the USB port.
- 5 Restart the computer by clicking **Start**, the arrow next to the **Lock** button, and **Restart**.

What should I do if I cannot write data to a floppy disk?

- Make sure the floppy disk is properly inserted in the drive.
- If the disk is inserted properly and you are still unable to write data to it, the disk may be full or write-protected. You can either use a floppy disk that is not write-protected or disable the write-protect feature.

PC Cards

What should I do if my PC Card does not work?

- ❑ Make sure the PC Card is inserted properly. See **Inserting a PC Card (page 43)** for more information.
- ❑ Make sure the PC Card is compatible with the Microsoft Windows operating system installed on your computer.
- ❑ See the manual that came with your PC Card for more information. You may need to install driver software if you are not using a Sony PC Card.
- ❑ If your PC Card, which worked normally before, does not work, you may need to install the most recent driver software. Follow these steps:
 - 1 Click **Start** and **Control Panel**.
 - 2 Click **System and Maintenance**.
 - 3 Click **System**.
 - 4 Click **Device Manager** on the left pane.
The **Device Manager** window appears.
 - 5 Double-click the device name for the PC Card to display the properties window.
 - 6 Select the **Driver** tab and click **Update Driver**.

Why doesn't my computer recognize attached devices?

For some PC Cards, if you alternate between Normal mode and Sleep or Hibernate mode while the card is inserted into the PC Card slot, your computer may not recognize the PC Card or the connected device. Restart the computer.

Why can't I insert my PC Card?

- ❑ Make sure you are inserting the card correctly. See **Inserting a PC Card (page 43)** for more information.
- ❑ You may not be able to use some PC Cards or some functions of the PC Card on your computer. See the manual that came with your PC Card for more information.

Audio/Video

What should I do if I cannot use my DV camcorder?

If it is prompted that the i.LINK device seems to be disconnected or turned off, the i.LINK cable may not be securely plugged into the port on your computer or camcorder. Unplug the cable, and plug it in once again. See **Connecting an i.LINK Device (page 99)** for more information.



i.LINK is a trademark of Sony used only to designate that a product contains an IEEE 1394 connection. The procedure to establish an i.LINK connection may vary, depending on a software application, an operating system, and a compatible i.LINK device. Not all products with an i.LINK connection can communicate with each other. See the manual that came with your compatible i.LINK device for more information on operating conditions and proper connection. Before connecting compatible i.LINK PC peripherals to your system, such as a CD-RW or hard disk drive, confirm their operating system compatibility and required operating conditions.

How do I turn off the Windows startup sound?

To turn off the Windows startup sound, follow these steps:

- 1 Click **Start** and **Control Panel**.
- 2 Click **Hardware and Sound**.
- 3 Click **Manage audio devices** under **Sound**.
- 4 On the **Sounds** tab, click to cancel the **Play Windows Startup sound** check box.
- 5 Click **OK**.

Memory Stick Media

What should I do if I cannot use Memory Stick media, which were formatted on a VAIO computer, on other devices?

You may need to reformat your Memory Stick media.

Formatting Memory Stick media erases all data, including music data previously saved on it. Before you reformat Memory Stick media, back up important data and confirm that the media does not contain files you want to keep.

- 1 Copy the data from the Memory Stick media onto your hard disk drive to save data or images.
- 2 Format the Memory Stick media by following the steps in **To format a Memory Stick media (page 53)**.

Why can't I save music files onto my Memory Stick media?

Copyright protected music cannot be checked out to any Memory Stick media other than those with the MagicGate logo.

! Use of recorded music requires permission from the copyright holders.

Sony is not responsible for music files that cannot be recorded from a CD or downloaded from other sources.

Can I copy images from a digital camera using Memory Stick media?

Yes, and you can view video clips that you have recorded with Memory Stick media-compatible digital cameras.

Why can't I write data to Memory Stick media?

Some versions of Memory Stick media are equipped with an erasure prevention switch to protect data from accidental erasure or overwriting. Make sure the erasure prevention switch is off.

Peripherals

What should I do if I cannot connect a USB device?

- ❑ If applicable, check the USB device is turned on and using its own power supply. For example, if you are using a digital camera, check if the battery is charged. If you are using a printer, check if the power cable is connected properly to the AC outlet.
- ❑ Try using another USB port on your computer. The driver could be installed to the specific port you used the first time you connected the device.
- ❑ See the manual that came with your USB device for more information. You may need to install software before you connect the device.
- ❑ Try connecting a simple, low-powered device such as a mouse to test if the port is working at all.
- ❑ USB hubs may prevent a device from working because of the distribution of power. We recommend you connect the device directly to your computer without a hub.

Docking Station

Why can't I use my TFT/DVI monitor connected to the DVI-D port?

The **DVI-D** port on the docking station is disabled when your computer is in STAMINA mode. Change the performance mode to SPEED mode and restart the computer. See **Selecting Performance Modes (page 104)** for mode selection.

What should I do if an error message appears when I press the UNDOCK button or select Undock Computer from the Start menu?

- ❑ When any device inserted or connected to the docking station is in use, you cannot disconnect your computer from the docking station. Save unsaved data, exit applications using such devices, and then try again.
If the above does not work, shut down your computer and disconnect it from the docking station.
- ❑ Make sure to return to the original log-on user before disconnecting your computer from the docking station. An attempt to disconnect it as any other user may cause malfunctions.
For switching users, see **Windows Help and Support**.

Support Options

This section contains information on where to go for answers to questions about your VAIO computer and the preinstalled software.

Sony Support Information

See the following sources for answers in the sequence listed below.

1 VAIO Computer Documentation

This on-screen **User Guide** (this manual) and the printed **Welcome mat** provide information on how to maximize your computer's capabilities and solve common problems.

2 Program Guides and Help Files

The preinstalled programs on your computer may be supplied with individual help guides. These guides are stored on the hard disk drive as on-screen help files. You can find the help files from the help menu under the specific program.

3 Operating System Online Support

Your computer comes preinstalled with a Microsoft Windows operating system. For operating system support, you can visit Microsoft customer support at: <http://support.microsoft.com/directory/>.

4 Sony Computing Support

This service provides instant access to information on commonly encountered problems. Type a description of the problem and the Knowledge Database searches for the corresponding solutions online.

You can visit the Sony online support Web site at the following URLs:

<http://esupport.sony.com/EN/VAIO/> for customers in USA

<http://www.sony.ca/support> for customers in Canada

<http://esupport.sony.com/ES/VAIO/> for customers in Spanish speaking Latin American countries or areas

<http://esupport.sony.com/ES/VAIO/BR/> for customers in Brazil

5 VAIO Update

When your computer is connected to the Internet, **VAIO Update** automatically notifies you when critical software and security information is posted on the support Web site. Click the **VAIO Update** notice to open the VAIO Support Web site and view the information.

For customers in Latin American countries or areas

Customer Information Center

If you do not find the information you are looking for at our site, you may call Sony directly. In order to receive the fastest and most efficient services, have the following information readily available:

1 Your VAIO computer model

You can find it at the lower right corner of the display on the notebook, and in the same place on the front panel of the CPU on the desktop.

2 Your computer's serial number

You can find it on the back or bottom of the notebook or on the back of the desktop; the serial number is the last 7 digits of the number below the barcode.

3 The operating system on your computer

4 The hardware component or the software program that is causing you the problem

5 A brief description of the problem

In order to contact a Sony technical support representative, call the following numbers:

In Argentina:

(011) 6770-SONY (7669)

In Mexico:

In Mexico City: 5002-9819

In the Mexican Republic: 01-800-759-7669

In Colombia:

01-800-550-7000

In Peru:

0-801-1-7000 or 511-6100

In Chile:

Sony answers: 800-261-800

From cellular phones: 02-754-6333

In Venezuela:

0-800-1-SONY-00 (0-800-1-7669-00)

In Panama:

800-2050

In Brazil:

(11) 3677-1080

Program Support Information

Depending on the computer model and particular configuration you purchased, your computer may not include all of the software programs listed below.

Contacts for Sony software products are listed below:

- ❑ For customers in USA
Web site <http://esupport.sony.com/EN/VAIO/>
Telephone 888-4-SONY-PC (888-476-6972)
- ❑ For customers in Canada
Web site <http://www.sony.ca/support>
Telephone 888-4-SONY-PC (888-476-6972)
- ❑ For customers in Spanish speaking Latin American countries or areas
Web site <http://esupport.sony.com/ES/VAIO/>
- ❑ For customers in Brazil
Web site <http://esupport.sony.com/ES/VAIO/BR/>

For contacts about third-party software products, see the following.

Adobe® Photoshop® Elements, Premiere®, Reader®

Adobe Systems Inc.

- ❑ For customers in USA and Canada
Web site <http://www.adobe.com/support>
Telephone 800-685-3652

America Online® (Dial-Up)

America Online, Inc.

- For customers in USA and Canada
Web site <http://www.aol.com>

AOL® Toolbar

America Online, Inc.

- For customers in USA and Canada
Web site <http://help.aol.com/help>

AOL® Instant Messenger™

America Online, Inc.

- For customers in USA and Canada
Web site <http://www.aim.com>

Bluetooth® Utility

TOSHIBA Corporation

For contacts about the software, see **Program Support Information (page 213)**.

Click to DVD® software

Sony Electronics Inc.

At the touch of a button, Click to DVD software allows you to automatically burn DVDs from a digital video (DV) device. Create DVDs by capturing video content straight from a DV device or by importing video from stored files — and you can also edit the video. Create DVD photo albums and slide shows with picture files or by importing pictures from a digital still camera. You can give a professional look to your DVDs by adding chapter menus, backgrounds, and menu screens. You are only a few clicks away from creating your own DVDs!

For contacts about the software, see **Program Support Information (page 213)**.

Diskeeper 9.0 Home

Diskeeper Corporation

- For customers in USA and Canada
Web site <http://www.diskeeper.com/support/support.asp>

InstantOn

InterVideo, Inc.

- For customers in USA and Canada
Web site <http://www.intervideo.com/jsp/Support.jsp>

Intel® PROSet/Wireless Software

Intel Corporation

- For customers in USA and Canada
Web site <http://support.intel.com>

LocationFree

Sony Electronics Inc.

For contacts about the software, see **Program Support Information** (page 213).

Microsoft® Office Basic Edition, Office Professional Edition, Office Small Business Edition, Office Ready, Office Ultimate

Microsoft Corp.

- ❑ For customers in USA and Canada
Web site <http://support.microsoft.com>

60-Day Trial Version of Microsoft® Office

! The Microsoft Office 60-Day Trial software included with this computer system is intended for evaluation purposes only. The software has been installed and you must activate the software before you can use it. Product activation procedures will be detailed during initial launch of the software; activation requires Internet access. This software has an expiration date of 60 days from the date of first use, at which time the software will operate under reduced-functionality mode, limiting end-user options and operations.

Microsoft Corp.

- ❑ For customers in USA and Canada
Web site <http://support.microsoft.com>

Microsoft® Internet Explorer, Movie Maker, Media Player, Works

Microsoft Corp.

- For customers in USA and Canada
Web site <http://support.microsoft.com>

MobiTV®

MobiTV, Inc.

- For customers in USA and Canada
Web site <http://www.mobitv.com/support/support.php>

14-Day Trial Version of Napster®

Napster, Inc.

- For customers in USA and Canada
Web site <http://www.napster.com>

Norton Internet Security™

Symantec Corporation

- For customers in USA and Canada
Web site <http://www.symantec.com/techsupp>

Protector Suite QL

Sony Electronics Inc.

Protector Suite QL Edition allows you to easily setup your fingerprint sensor equipped on your computer. Protector Suite QL supports fingerprint logon, fast user switching, file encryption, registering forms and more.

For contacts about the software, see **Program Support Information (page 213)**.

Quickbooks Free Starter Edition

Intuit Inc.

- For customers in USA and Canada
Web site <http://www.intuit.com/support/>

Roxio® Easy Media Creator® 9 Suite

Sonic Solutions

- For customers in USA and Canada
Web site <http://support.sonic.com/>

SafeIT-Digital Document Shredder

SafeIT Security Ltd.

- For customers in USA and Canada
Web site <http://www.safeit.com/support>

SmartWi™ Connection Utility

Sony Electronics Inc.

SmartWi Connection Utility allows you to easily switch between the various wireless components (Wireless LAN, Wireless WAN, and Bluetooth® technology connectivity) that came with your computer.

For contacts about the software, see **Program Support Information (page 213)**.

SonicStage® software

Sony Electronics Inc.

The SonicStage jukebox software program gives you all the tools you need to manage music on your computer. SonicStage software supports high-quality digital audio storage, a sleek player skin design, and audio CD burning capability.

For contacts about the software, see **Program Support Information (page 213)**.

SonicStage Mastering Studio™ software

Sony Electronics Inc.

Use SonicStage Mastering Studio software to record songs from analog records or cassette tapes into your computer and output them to CDs, DVDs, or audio files in WAV format.

For contacts about the software, see **Program Support Information (page 213)**.

System Mechanic® 6

iolo technologies®, LLC

- ❑ For customers in USA and Canada

Web site <http://www.iolo.com/contactus.cfm>

VAIO® Action Setup

Sony Electronics Inc.

VAIO Action Setup manages the settings for your computer's shortcut keys.

For contacts about the software, see **Program Support Information (page 213)**.

VAIO® Camera Capture Utility

Sony Electronics Inc.

VAIO Camera Capture Utility is provided for capturing still images and movies with the external camera connected to a USB port or an i.LINK® port on your computer or with the built-in **MOTION EYE®** camera on your computer.

For contacts about the software, see **Program Support Information (page 213)**.

VAIO® Camera Utility

Sony Electronics Inc.

VAIO Camera Utility provides you with various video quality settings when using the internal camera.

For contacts about the software, see **Program Support Information (page 213)**.

VAIO® Central

Sony Electronics Inc.

VAIO Central provides a centralized location that gathers resources to configure your VAIO computer and view your computer's configuration and specifications.

For contacts about the software, see **Program Support Information** ([page 213](#)).

VAIO® Diagnostic

Sony Electronics Inc.

For contacts about the software, see **Program Support Information** ([page 213](#)).

VAIO® Edit Component

Sony Electronics Inc.

VAIO Edit Component provides enhanced editing functionality when using Adobe Premiere Pro or Adobe Premiere Elements on your VAIO computer.

For contacts about the software, see **Program Support Information** ([page 213](#)).

VAIO® HDD Protection

Sony Electronics Inc.

VAIO HDD Protection allows you to customize your settings for protecting your hard disk drive against shock hazards.

For contacts about the software, see **Program Support Information** ([page 213](#)).

VAIO® LAN Setting Utility

Sony Electronics Inc.

For contacts about the software, see **Program Support Information** ([page 213](#)).

VAIO Media™ software

Sony Electronics Inc.

VAIO Media™ software brings multimedia to your network, enabling you to share music, video, and still image files between your VAIO® computers. You can set up one or more VAIO computers as "media servers," which store your multimedia files and make them available to other compatible VAIO computers on your wired or wireless network.

For contacts about the software, see **Program Support Information** ([page 213](#)).

VAIO® Security Center

Sony Electronics Inc.

Sony cares about your VAIO personal computer. The VAIO Security Center highlights some of the security features your machine includes.

For contacts about the software, see **Program Support Information** ([page 213](#)).

VAIO® Touch Launcher

Sony Electronics Inc.

VAIO Touch Launcher allows you to run an application program or change the sound/display settings with the buttons on the launcher window.

For contacts about the software, see **Program Support Information** ([page 213](#)).

VAIO® Update

Sony Electronics Inc.

The VAIO Update utility helps you keep your VAIO® computer up to date by regularly checking the Sony online support Web site for important software updates and information for your specific VAIO computer model.

For contacts about the software, see **Program Support Information (page 213)**.

VAIO Video & Photo Suite

Sony Electronics Inc.

VAIO Content Importer and VAIO Content Exporter are included in this utility software. This software enables you to import and export your media files to or from a DVD, digital still camera, or camcorder.

For contacts about the software, see **Program Support Information (page 213)**.

VAIO® Wireless Switch Setting Utility

Sony Electronics Inc.

For contacts about the software, see **Program Support Information (page 213)**.

WinDVD® software for VAIO® computers

InterVideo, Inc.

- ❑ For customers in USA and Canada
Web site <http://www.intervideo.com/jsp/Support.jsp>
Telephone 510-651-0888

Xdrive™

America Online, Inc.

- For customers in USA and Canada
Web site <http://www.xdrive.com/support>

Zoom Utility

Sony Electronics Inc.

The Zoom Utility will allow you to magnify a portion of the screen.

For contacts about the software, see **Program Support Information (page 213)**.

