

IGBT Gate Driver + DC/DC Converter

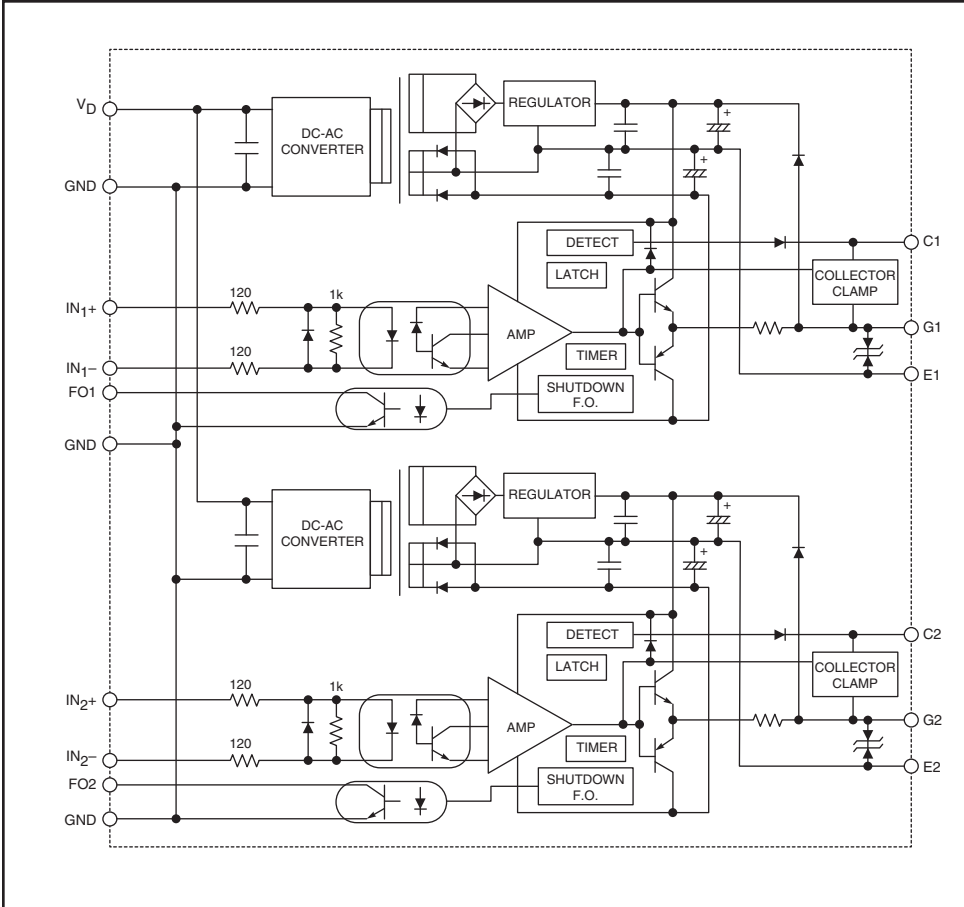

Circuit Diagram



Description:

VLA553-01R / -02R is a hybrid integrated circuit designed for driving IGBT modules in the new Mega Power Dual package.

Features:

- Directly Mountable on the New MPD
- Built in Isolated DC-DC Converter for Gate Drive
- Output Peak Current is $\pm 24A$ (max)
- Built in Short Circuit Protection with Soft Shutdown
- Built in Collector Clamp Circuit
- Electrical Isolation Voltage 4000 V_{rms} (for 1 Minute)
- CMOS Compatible Input Interface

Applications:

- Gate Driver for 1200V and 1700V New Mega Power Dual IGBT Modules

Recommended IGBT Modules:

CM2500DY-24S – VLA553-01R
 CM1800DY-34S – VLA553-02R

VLA553-01R / -02R
IGBT Gate Driver + DC/DC Converter

Absolute Maximum Ratings, $T_a = 25^\circ\text{C}$ unless otherwise specified

Characteristics	Symbol	Rating	Units
Supply Voltage (DC)	V_D	-1 ~ 16.5	Volts
Input Signal Voltage (Applied Between IN+ and IN-, 50% Duty Cycle, Pulse Width 1ms)	V_I	-7 ~ +7	Volts
Output Peak Current (Pulse Width 3 μ s)	I_{OHP}	-24	Amperes
	I_{OLP}	24	Amperes
Isolation Voltage (Sine Wave Voltage 60Hz, for 1 min.)	V_{iso}	4000	V_{rms}
Operating Temperature (No Condensation Allowable)	T_{opr}	-25 ~ 70	$^\circ\text{C}$
Storage Temperature (No Condensation Allowable)	T_{stg}	-40 ~ 85	$^\circ\text{C}$
Gate Drive Current, Gate Average Current (Per One Circuit)	I_{drive}	210	mA
Main Circuit Voltage (Voltage Between P and N)	V_{DC_Link}	840 (-01R)	Volts
	V_{DC_Link}	1200 (-02R)	Volts

Electrical Characteristics, $T_a = 25^\circ\text{C}$, $V_D = 15\text{V}$, $f = 3\text{kHz}$ unless otherwise specified

Characteristics	Symbol	Test Conditions	Min.	Typ.	Max.	Units
Supply Voltage	V_D	Recommended Range	14.2	15	15.8	Volts
Pull-up Voltage on Input Side	V_{IN}	Recommended Range (For Input Signal)	4.75	5	5.25	Volts
"H" Input Signal Current	I_{IH}	Recommended Range	10	12	16	mA
Switching Frequency	f	Recommended Range	—	—	5	kHz
Gate Resistance	R_G	Recommended Range	0	—	—	Ω
Plus Bias Output Voltage	V_{OH}		14	15.3	16.5	Volts
Minus Bias Output Voltage	V_{OL}		-5.5	-7	-11	Volts
"L-H" Propagation Time	t_{PLH}	$I_{IH} = 12\text{mA}$	0.3	—	1	μs
"H-L" Propagation Time	t_{PHL}	$I_{IH} = 12\text{mA}$	0.3	—	1	μs
Clamp Zener Voltage	V_Z^{*1}	Total Zener Voltage in Collector	901	950 (-01R)	999	Volts
		Clamp Circuit at $I_Z = 1\text{mA}$, $T_j = 25^\circ\text{C}$	1284	1350 (-02R)	1419	Volts
SC Detect Voltage	V_{SC}		15	—	—	Volts

*1 It depends on the condition of use, however actual clamp voltage of collector rises by 300V from 200V to V_Z .

VLA553-01R / -02R
IGBT Gate Driver + DC/DC Converter

Application Example

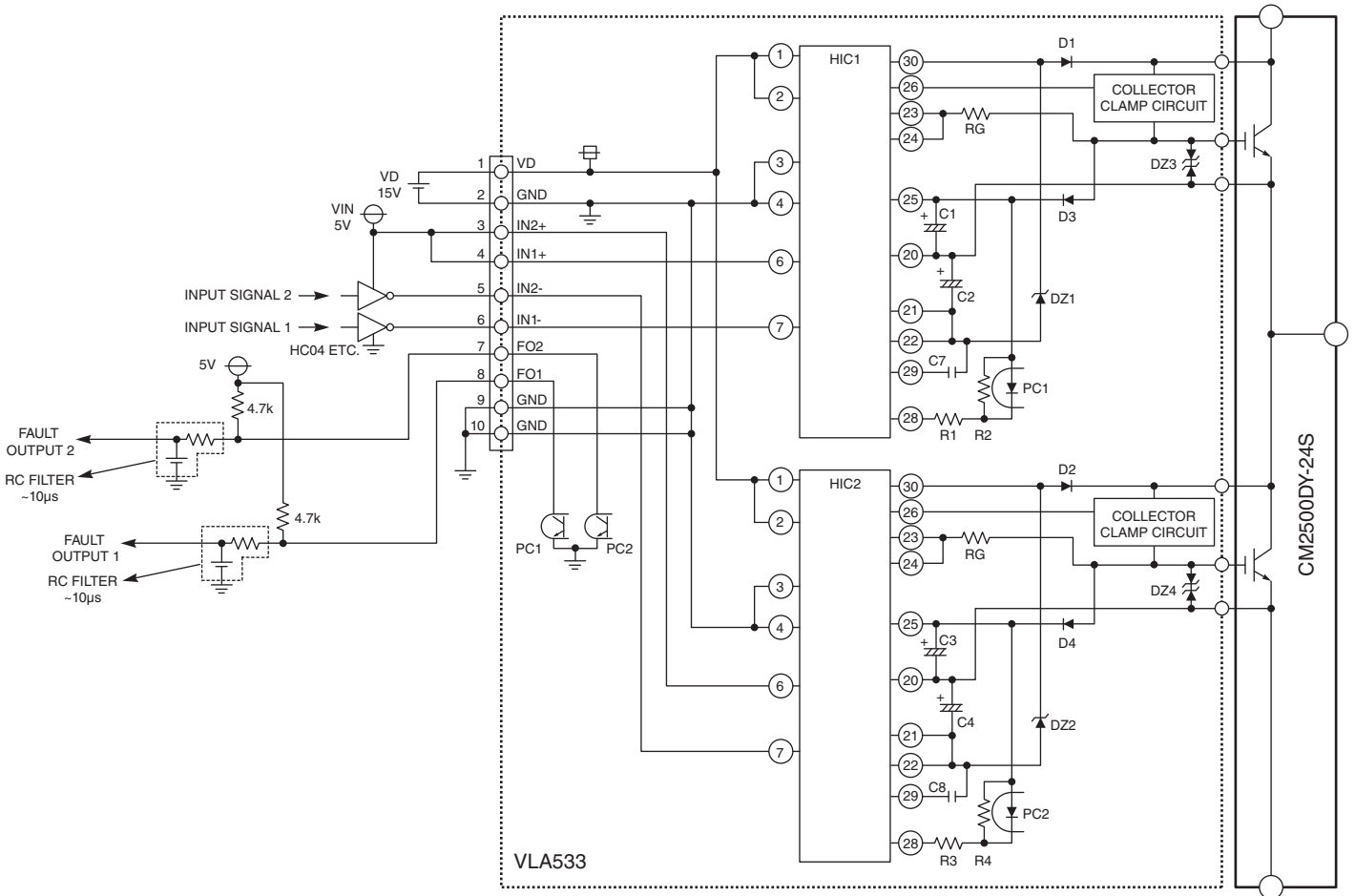

VLA553-01R / -02R
IGBT Gate Driver + DC/DC Converter

V_{CC} , V_{EE} | T_a CHARACTERISTICS
(TYPICAL)

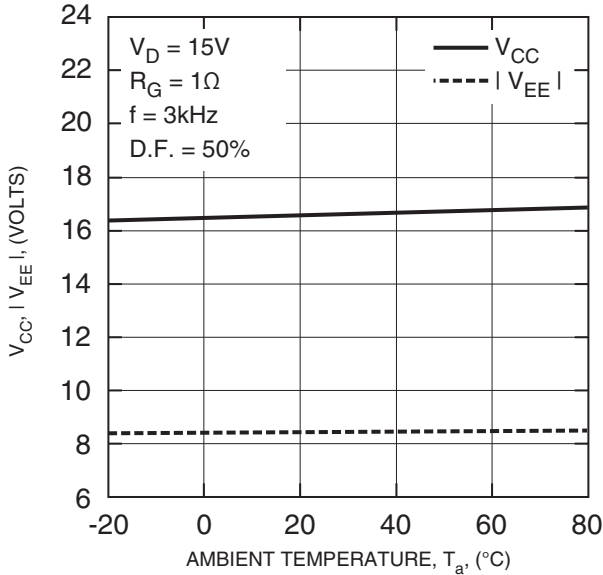

V_{CC} , V_{EE} | I_O CHARACTERISTICS
(TYPICAL)

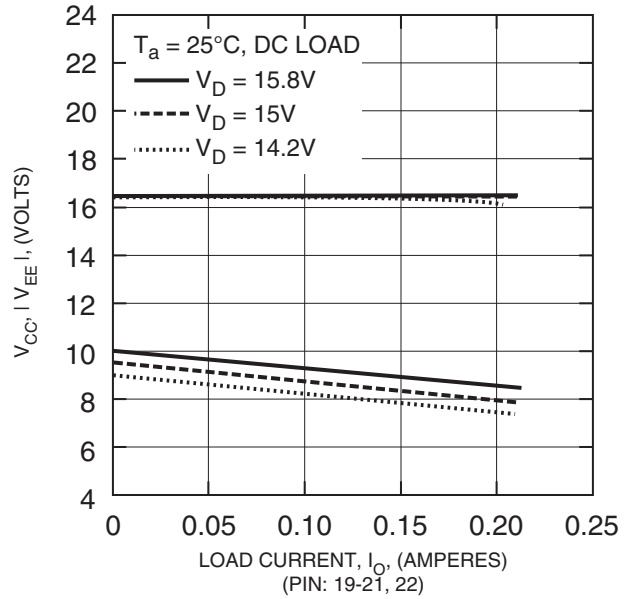

t_{PLH} , t_{PHL} - T_a CHARACTERISTICS
(TYPICAL)

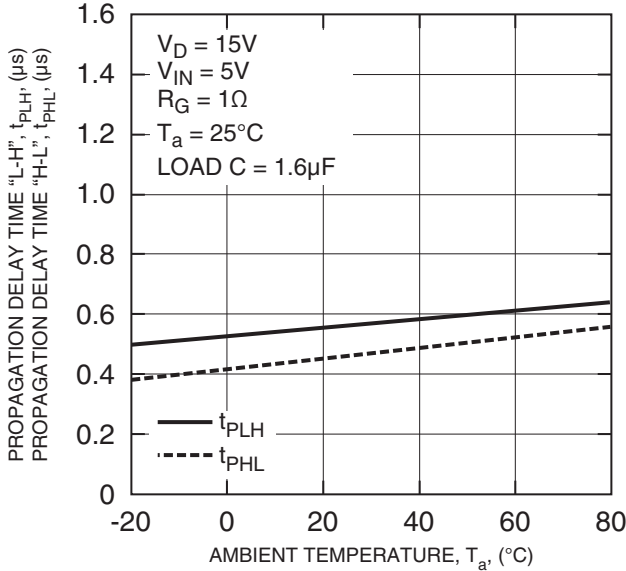

t_{PLH} , t_{PHL} - V_I CHARACTERISTICS
(TYPICAL)

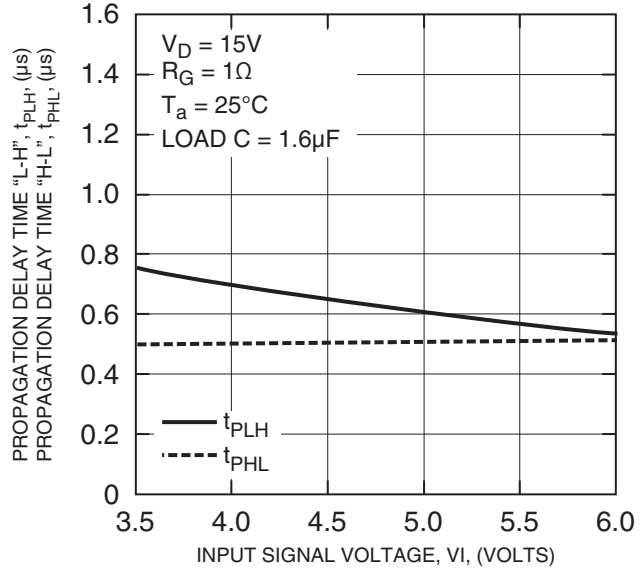

VLA553-01R / -02R
IGBT Gate Driver + DC/DC Converter

t_{trip} - T_a CHARACTERISTICS (TYPICAL)

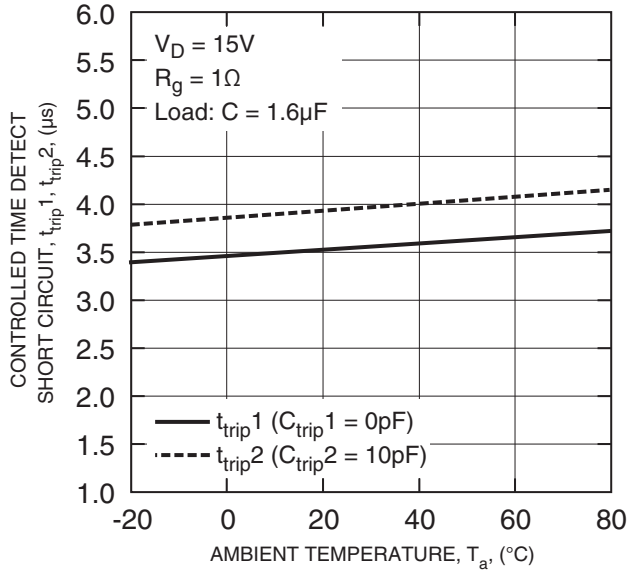

t_{trip} - C_{trip} CHARACTERISTICS (TYPICAL)

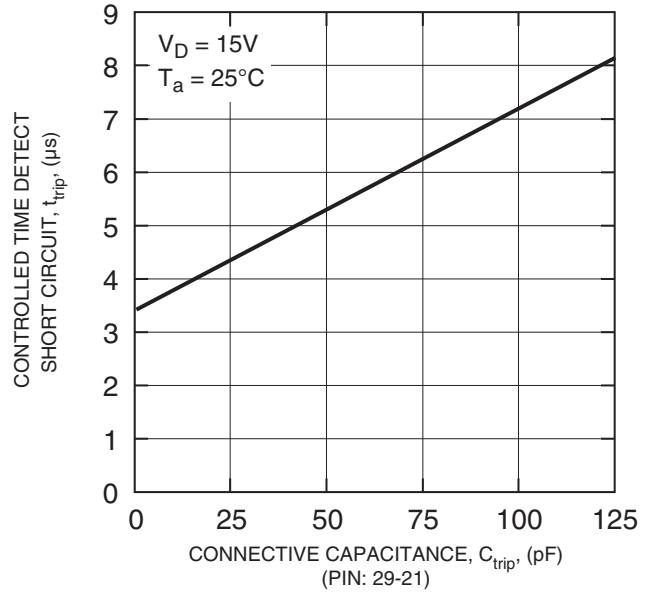

I_D - I_O CHARACTERISTICS (TYPICAL)

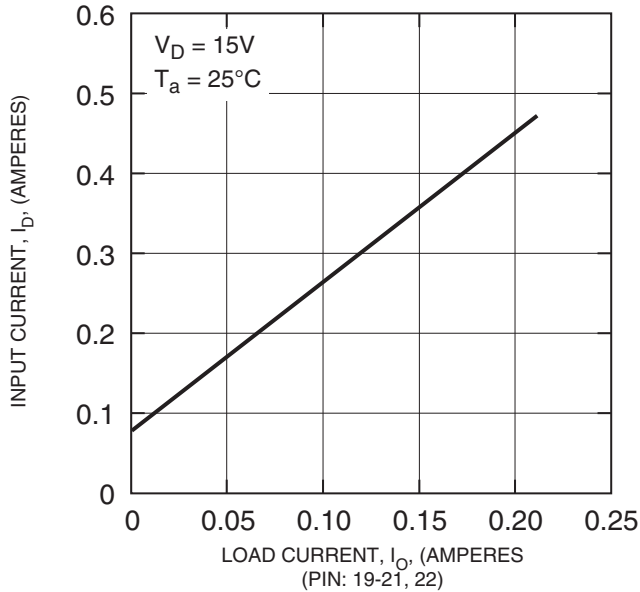

V_{OH} , V_{OL} - T_a CHARACTERISTICS (TYPICAL)

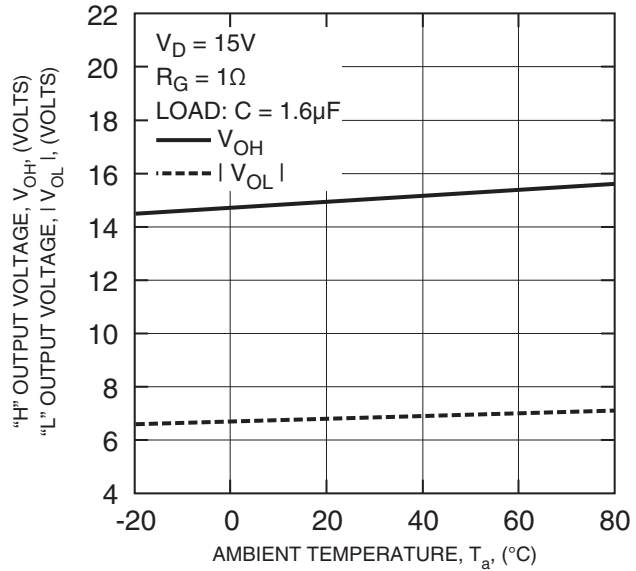

VLA553-01R / -02R
IGBT Gate Driver + DC/DC Converter

η - I_{drive} CHARACTERISTICS
(TYPICAL)

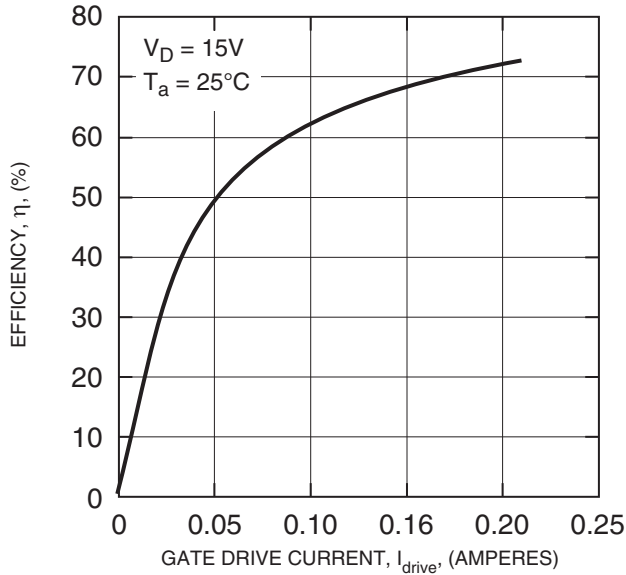

V_{CC} , $|V_{EE}|$ - V_D CHARACTERISTICS
(TYPICAL)

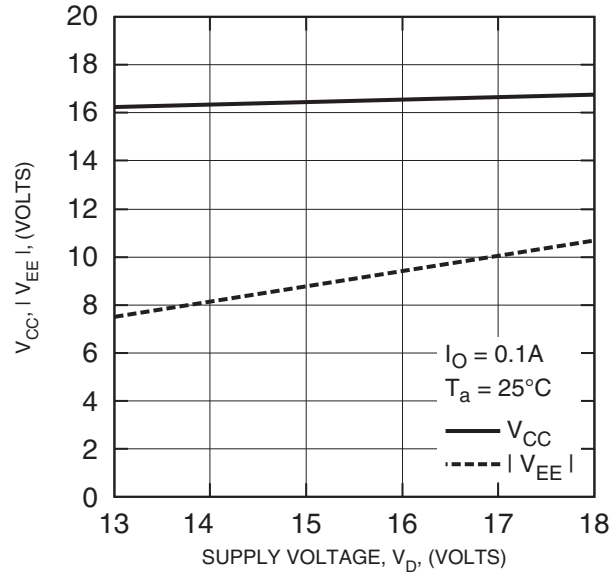

I_{drive} - T_a CHARACTERISTICS
(TYPICAL)

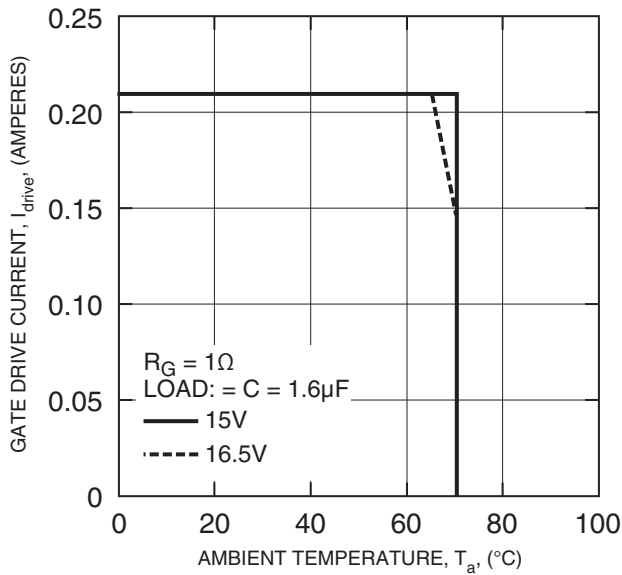

η - V_D CHARACTERISTICS
(TYPICAL)

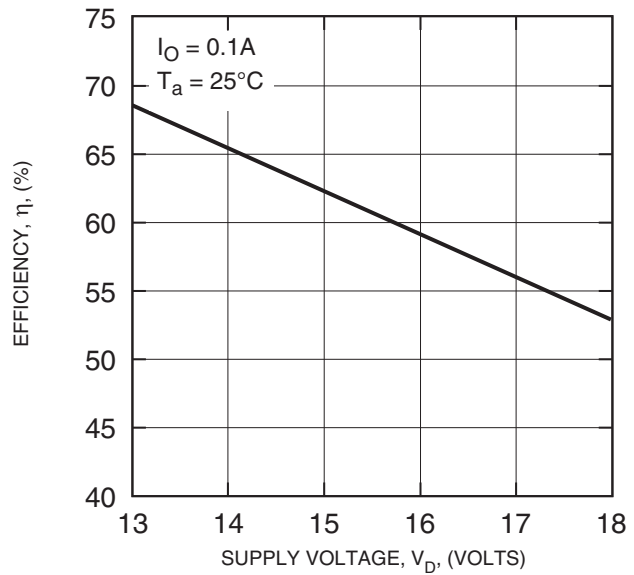

VLA553-01R / -02R
IGBT Gate Driver + DC/DC Converter

TOTAL ZENER VOLTAGE CHARACTERISTICS OF VLA533-01R (TYPICAL)

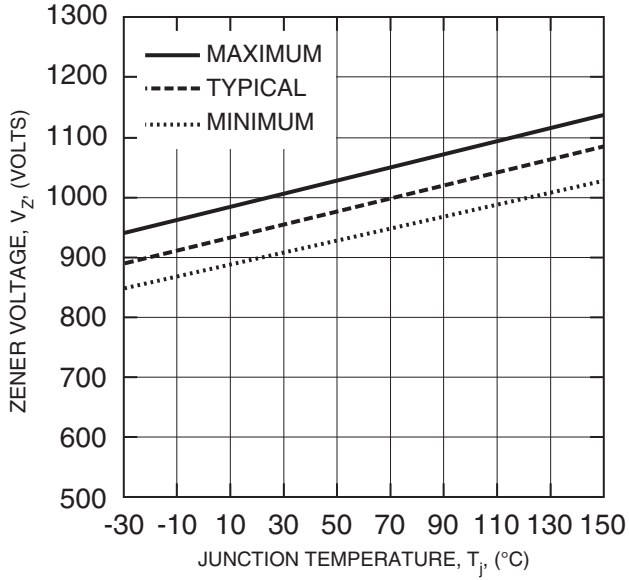

TOTAL ZENER VOLTAGE CHARACTERISTICS OF VLA533-02R (TYPICAL)

