

Service Manual

ViewSonic VG712s/b

Model No. VLCDS23719-6W/7W

17" Color TFT LCD Display

(VG712s/b_SM_835_1b Rev. 1b Oct. 2004)

ViewSonic® 381 Brea Canyon Road, Walnut, California 91789 USA - (800) 888-8583

Copyright

Copyright © 2004 by ViewSonic Corporation. All rights reserved. No part of this publication may be reproduced, transmitted, transcribed, stored in a retrieval system, or translated into any language or computer language, in any form or by any means, electronic, mechanical, magnetic, optical, chemical, manual or otherwise, without the prior written permission of ViewSonic Corporation.

Disclaimer

ViewSonic makes no representations or warranties, either expressed or implied, with respect to the contents hereof and specifically disclaims any warranty of merchantability or fitness for any particular purpose. Further, ViewSonic reserves the right to revise this publication and to make changes from time to time in the contents hereof without obligation of ViewSonic to notify any person of such revision or changes.

Trademarks

Optiquest is a registered trademark of ViewSonic Corporation.
ViewSonic is a registered trademark of ViewSonic Corporation.
All other trademarks used within this document are the property of their respective owners.

Revision History

Revision	SM Editing Date	Documents Number		Description of Changes	Editor
		DCN Number	ECR Number		
1a	06/18/04	4475		Initial Release	A. Lu
1b	10/18/04	4774	4626	Change Panel From AUO M170EN05 V.8 48.62701.003 12ms/20ms To AUO M170EG01 V.0 48.62701.004 12ms	A. Lu

TABLE OF CONTENTS

1. Precautions and Safety Notices	1
2. Specification	5
3. Front Panel Function Control Description	14
4. Circuit Description	21
5. Adjusting Procedure	24
6. Trouble Shooting Flow Chart	49
7. Recommended Spare Parts List	53
8. Exploded Diagram And Spare Parts List	61
9. Block Diagram	65
10. Schematic Diagrams	66
11. PCB Layout Diagrams	72

1. Precautions and Safety Notices

1. Appropriate Operation

- (1) Turn off the product before cleaning.
- (2) Use only a dry soft cloth when cleaning the LCD panel surface.
- (3) Use a soft cloth soaked with mild detergent to clean the display housing.
- (4) Use only high quality and safety approved AC/DC power adapter.
- (5) Disconnect the power plug from AC outlet if the product is not used for a long period of time.
- (6) If smoke, abnormal noise, or strange odor is present, immediately switch the LCD display off.
- (7) Do not touch the LCD panel surface with sharp or hard objects.
- (8) Do not place heavy objects on the LCD display, video cable, or power cord.
- (9) Do not use abrasive cleaners, waxes or solvents for your cleaning.
- (10) Do not operate the product under the following conditions:
 - Extremely hot, cold or humid environment.
 - Areas susceptible to excessive dusts and dirt.
 - Near any appliance generating a strong magnetic field.
 - Place in direct sunlight.

2. Caution

No modification of any circuit should be attempted. Service work should only be performed after you are thoroughly familiar with all of the following safety checks and servicing guidelines.

3. Safety Check

Care should be taken while servicing this LCD display. Because of the high voltage used in the inverter circuit, the voltage is exposed in such areas as the associated transformer circuits.

4. Power Supply Requirements







The external power converter for this display utilizes AC and DC cords, AC cord is detachable, but DC cord is permanently attached. Any attempt to replace another adapter could result in serious problems on the display.

5. LCD Module Handling Precautions

5.1 Handling Precautions

- (1) Since front polarizer is easily damaged, pay attention not to scratch it.
- (2) Be sure to turn off power supply when inserting or disconnecting from input connector.
- (3) Wipe off water drop immediately. Long contact with water may cause discoloration or spots.
- (4) When the panel surface is soiled, wipe it with absorbent cotton or other soft cloth.
- (5) Since the panel is made of glass, it may break or crack if dropped or bumped on hard surface.
- (6) Since CMOS LSI is used in this module, take care of static electricity and insure human earth when handling.
- (7) Do not open nor modify the Module Assembly.
- (8) Do not press the reflector sheet at the back of the module to any directions.
- (9) In case if a Module has to be put back into the packing container slot after once it was taken out from the container, do not press the center of the CCFL Reflector edge. Instead, press at the far ends of the CFL Reflector edge softly. Otherwise the TFT Module may be damaged.
- (10) At the insertion or removal of the Signal Interface Connector, be sure not to rotate nor tilt the Interface Connector of the TFT Module.
- (11) After installation of the TFT Module into an enclosure (LCD monitor housing, for example), do not twist nor bend the TFT Module even momentary. At designing the enclosure, it should be taken into consideration that no bending/twisting forces are applied to the TFT Module from outside. Otherwise the TFT Module may be damaged.
- (12) Cold cathode fluorescent lamp in LCD contains a small amount of mercury. Please follow local ordinances or regulations for disposal.
- (13) Small amount of materials having no flammability grade is used in the LCD module. The LCD module should be supplied by power complied with requirements of Limited Power Source (IEC60950 or UL1950), or be applied exemption.
- (14) The LCD module is designed so that the CFL in it is supplied by Limited Current Circuit (IEC60950 or UL1950). Do not connect the CFL in Hazardous Voltage Circuit.

5.2 Handling and Placing Methods

Correct Methods:	Incorrect Methods:
<p>Only touch the metal frame of the LCD panel or the front cover of the monitor. Do not touch the surface of the polarizer.</p>	<p>Surface of the LCD panel is pressed by fingers and that will probably cause "Mura."</p>
	
	
<p>Take out the monitor with cushions</p>	<p>Take out the monitor by grasping the LCD panel. That will probably cause "Mura."</p>
	

Place the monitor on a clean and soft foam pad.



Place the monitor on foreign objects. That will probably scratch the surface of the panel or cause "Mura."



The panel is placed facedown on the lap. That will probably cause "Mura."



2. Specification

1. General Requirements

Test Resolution & Frequency	1280x1024 @ 60Hz
Test Image Size	Full Size
Contrast and Brightness Controls	Factory Default: Contrast = 70%, Brightness = 100%

2. Signal Interface

Video Interface

Analog Input Connector	DB-15 (Analog)
Digital Input Connector	DVI-I (Digital)
Default Input Connector	Defaults to the first detected input
Video Cable Connector DB-15 Pin out	Compliant DDC 2B
Video Signals	1. Video RGB (Analog) Separate 2. TMDS (Digital)
Video Impedance	75 Ohms (Analog), 100 Ohms (Digital)
Exclusions	Not compatible with interlaced video

3. Power

Power Supply

Power Supply (Adapter)	Part Number: LSE 0107A1240
Input Voltage Range	90 to 264 VAC
Over Current Protection	12.7V ~ 18V full load
Power Dissipation	40 Watts (typ.)

4. Electrical Requirements

Horizontal / Vertical Frequency

Horizontal Frequency	30 – 82 KHz
Vertical Refresh Rate	50 – 85* Hz. 1. Since 75Hz in panel spec, the image quality might be worse than <= 75Hz 2. For resolution 1280 x 1024, the vertical refresh rate up to 75 Hz; for the rest resolutions, the vertical refresh rate up to 85Hz
Maximum Pixel Clock	135 MHz
Primary Preset	1280x1024@60Hz
Look up table timing	

<<Analog>>	<<Digital>>
640 x 350 @ 70Hz, 31.5KHz	640 x 350 @ 70Hz, 31.5KHz
640 x 400 @ 60Hz, 31.5KHz	640 x 400 @ 60Hz, 31.5KHz
640 x 400 @ 70Hz, 31.5KHz	640 x 400 @ 70Hz, 31.5KHz
640 x 480 @ 50Hz, 24.7KHz	640 x 480 @ 50Hz, 24.7KHz
640 x 480 @ 60Hz, 31.5KHz	640 x 480 @ 60Hz, 31.5KHz
640 x 480 @ 67Hz, 35.0KHz	640 x 480 @ 67Hz, 35.0KHz
640 x 480 @ 72Hz, 37.9KHz	640 x 480 @ 72Hz, 37.9KHz
640 x 480 @ 75Hz, 37.5KHz	640 x 480 @ 75Hz, 37.5KHz
640 x 480 @ 85Hz, 43.27KHz	640 x 480 @ 85Hz, 43.27KHz
720 x 400 @ 70Hz, 31.5KHz	720 x 400 @ 70Hz, 31.5KHz
800 x 600 @ 56Hz, 35.1KHz	800 x 600 @ 56Hz, 35.1KHz
800 x 600 @ 60Hz, 37.9KHz	800 x 600 @ 60Hz, 37.9KHz
800 x 600 @ 75Hz, 46.9KHz	800 x 600 @ 75Hz, 46.9KHz
800 x 600 @ 72Hz, 48.1KHz	800 x 600 @ 72Hz, 48.1KHz
800 x 600 @ 85Hz, 53.7KHz	800 x 600 @ 85Hz, 53.7KHz
832 x 624 @ 75Hz, 49.7KHz	832 x 624 @ 75Hz, 49.7KHz
1024 x 768 @ 60Hz, 48.4KHz	1024 x 768 @ 60Hz, 48.4KHz
1024 x 768 @ 70Hz, 56.5KHz	1024 x 768 @ 70Hz, 56.5KHz
1024 x 768 @ 72Hz, 58.1KHz	1024 x 768 @ 72Hz, 58.1KHz
1024 x 768 @ 75Hz, 60.0KHz	1024 x 768 @ 75Hz, 60.0KHz
1024 x 768 @ 85Hz, 68.67KHz	1024 x 768 @ 85Hz, 68.67KHz
1152 x 864 @ 75Hz, 67.5KHz	1152 x 864 @ 75Hz, 67.5KHz
1152 x 870 @ 75Hz, 68.7KHz	1152 x 870 @ 75Hz, 68.7KHz
1280 x 1024 @ 60Hz, 63.4KHz	1280 x 1024 @ 60Hz, 63.4KHz
1280 x 1024 @ 75Hz, 79.97KHz	1280 x 1024 @ 75Hz, 79.97KHz
1280x 720 @ 60Hz, 45KHz (HDTV)	1280x 720 @ 60Hz, 45KHz (HDTV)

Changing Modes

<p>Maximum Mode Change Blank Time for image stability. Note:</p> <ol style="list-style-type: none"> 3 seconds (Max), excluding "Auto Adjust" time Under DOS mode (640 x 350, 720 x 400 & 640 x 400), it should recall factory setting when execute "Auto Adjust" The monitor needs to do "Auto Adjust" the first time a new mode is detected 	<ol style="list-style-type: none"> While running Change Mode, Auto Adjust or Memory Recall, the image shall blank.
---	---

5. Audio Interface

Speaker Specification

Line input connection	3.5 mm stereo jack
Line input signal	1.0 Vrms
Line input impedance	10 k Ohm
Maximum power output (Electric)	3 W @ < 8% DISTORTION
Signal to Noise Ratio	72 dB
Frequency response	400 Hz – 20 KHz
Distortion	< 8 % THD (@1KHz)

6. LCD Panel

Panel Characteristics

Source panel	AU panel (M170EG01 V0)
Size	17" diagonal screen size
Type	MVA type with LVDS interface
Pixel	1280*1024 addressable pixels
Pixel Pitch	0.264mm*0.264mm pixel pitch
Brightness	300 cd/m2 (Typ after 30 minute warm up)
Contrast Ratio	500:1 (Typ), 300:1 (Min)
Viewing Angle(Horizontal)	140 deg @ CR>10
Viewing Angle (Vertical)	130 deg @ CR>10
Response Time	12 ms (Tr=9ms, TF =3 ms) (Typ.)
Backlight lamps	4 CCFL backlight lamps
Backlight Life	50,000 Hours (Typ.) / 45,000 hours (Min.)

7. Mechanical

Dimensions

Width	378 mm (14.9 inch)
Height	405 mm (16.0 inch)
Depth	177 mm (7.0 inch)
Monitor Weight	5.3 kg / 11.66 lbs

Ergonomics

Tilt Up	20 ° +/- 20%
Tilt Down	-5 ° +/- 20%

8. Environmental

Environmental Conditions

Operating Temperature	0°C to +40°C
Storage Temperature	-20°C to +60°C
Operating Relative Humidity	20% to 90% RH Non-Condensing
Storage Relative Humidity	5% to 90% RH Non-Condensing
Operating Altitude	0 to +3,000 meters
Storage Altitude	0 to +12,000 meters

9. EDID

Appendix E: Analog EDID

VG712s/b Analog EDID

Time: 13:10:50

Date: Wed Jan 14, 2004

VIEWSONIC CORPORATION
EDID Version # 1, Revision # 3
DDCTest For: ViewSonic VG712s/b

128 BYTES OF EDID CODE:

	0	1	2	3	4	5	6	7	8	9		
0		00	FF	FF	FF	FF	FF	00	5A	63		
10		19	7B	01	01	01	01	0E	01	03		
20		08	22	1B	78	2E	C5	C6	A3	57	4A	
30		9C	23	12	4F	54	BF	EF	80	81	80	
40		61	59	45	59	31	59	01	01	01	01	
50		01	01	01	01	30	2A	00	98	51	00	
60		2A	40	30	70	13	00	52	0F	11	00	
70		30	00	1E	00	00	00	FF	00	50	33	55
80		30	34	30	31	30	30	30	30	31	0A	
90		00	00	00	FD	00	32	55	1E	52	0E	
100		00	0A	20	20	20	20	20	00	00		
110		00	FC	00	56	47	37	31	32	73	0A	
120		20	20	20	20	20	00	94				

- (08-09) ID Manufacturer Name = VSC
- (11-10) Product ID Code = 7B19
- (12-15) Last 5 Digits of Serial Number = Not Used
- (16) Week of Manufacture = 01
- (17) Year of Manufacture = 2004
- (10-17) Complete Serial Number = See Descriptor Block
- (18) EDID Version Number = 1
- (19) EDID Revision Number = 3
- (20) VIDEO INPUT DEFINITION:
Analog Signal
0.700, 0.300 (1.000 Vp-p)
Separate Syncs

- (21) Maximum Horizontal Image Size = 340 mm
- (22) Maximum Vertical Image Size = 270 mm
- (23) Display Gamma = 2.20
- (24) Power Management and Supported Feature(s):
Active Off/Very Low Power, Standard Default Color Space,
Preferred Timing Mode
Display Type = R/G/B Color
- (25-34) CHROMA INFO:
Red X - 0.640 Green X - 0.290 Blue X - 0.140 White X - 0.310
Red Y - 0.340 Green Y - 0.610 Blue Y - 0.070 White Y - 0.330
- (35) ESTABLISHED TIMING I:
720 X 400 @ 70Hz (IBM,VGA)
640 X 480 @ 60Hz (IBM,VGA)
640 X 480 @ 67Hz (Apple,Mac II)
640 X 480 @ 72Hz (VESA)
640 X 480 @ 75Hz (VESA)
800 X 600 @ 56Hz (VESA)
800 X 600 @ 60Hz (VESA)
- (36) ESTABLISHED TIMING II:
800 X 600 @ 72Hz (VESA)
800 X 600 @ 75Hz (VESA)
832 X 624 @ 75Hz (Apple,Mac II)
1024 X 768 @ 60Hz (VESA)
1024 X 768 @ 70Hz (VESA)
1024 X 768 @ 75Hz (VESA)
1280 X 1024 @ 75Hz (VESA)
- (37) Manufacturer's Reserved Timing:
1152 X 870 @ 75Hz (Apple,Mac II)
- (38-53) Standard Timing Identification:
1280 X 1024 @60Hz
1024 X 768 @85Hz
800 X 600 @85Hz
640 X 480 @85Hz
Not Used
Not Used
Not Used
Not Used

(54-71) Detailed Timing / Descriptor Block 1:

1280x1024 Pixel Clock: 108.00 MHz

Horizontal Image Size: 338 mm Vertical Image Size: 271 mm

Refreshed Mode: Non-Interlaced Normal Display - No Stereo

Horizontal:

Active Time: 1280 pixels Blanking Time: 408 pixels

Sync Offset: 48 pixels Sync Pulse Width: 112 pixels

Border: 0 pixels Frequency: 63.98 KHz

Vertical:

Active Time: 1024 lines Blanking Time: 42 lines

Sync Offset: 1 lines Sync Pulse Width: 3 lines

Border: 0 lines Frequency: 60.02 Hz

Digital Separate, Horizontal Polarity (+) Vertical Polarity (+)

(72-89) Detailed Timing / Descriptor Block 2:

Monitor Serial Number:

P3U040100001

(90-107) Detailed Timing / Descriptor Block 3:

Monitor Range Limits:

Min Vertical Freq - 50 Hz

Max Vertical Freq - 85 Hz

Min Horiz. Freq - 30 KHz

Max Horiz. Freq - 82 KHz

Pixel Clock - 140 MHz

Secondary GTF - Not Supported

(108-125) Detailed Timing / Descriptor Block 4:

Monitor Name:

VG712s/b

(126) No Extension EDID Block(s)

(127) CheckSum OK

Appendix F: Digital EDID

VG712s/b Digital EDID

Time: 08:14:47

Date: Fri Jan 30, 2004

VIEWSONIC CORPORATION
EDID Version # 1, Revision # 3
DDCTest For: ViewSonic VG712s/b

128 BYTES OF EDID CODE:

0 1 2 3 4 5 6 7 8 9

0 | 00 FF FF FF FF FF FF 00 5A 63
10 | 19 7B 01 01 01 01 01 0E 01 03
20 | 80 22 1B 78 2E C5 C6 A3 57 4A
30 | 9C 23 12 4F 54 BF EF 80 81 80
40 | 61 59 45 59 31 59 31 0A 01 01
50 | 01 01 01 01 30 2A 00 98 51 00
60 | 2A 40 30 70 13 00 52 0F 11 00
70 | 00 1E 00 00 00 FF 00 50 33 55
80 | 30 34 30 31 30 30 30 30 31 0A
90 | 00 00 00 FD 00 32 55 1E 52 0E
100 | 00 0A 20 20 20 20 20 20 00 00
110 | 00 FC 00 56 47 37 31 32 73 0A
120 | 20 20 20 20 20 20 00 E3

- (08-09) ID Manufacturer Name = VSC
(11-10) Product ID Code = 7B19
(12-15) Last 5 Digits of Serial Number = Not Used
(16) Week of Manufacture = 01
(17) Year of Manufacture = 2004
(10-17) Complete Serial Number = See Descriptor Block
(18) EDID Version Number = 1
(19) EDID Revision Number = 3
(20) VIDEO INPUT DEFINITION:
Digital Signal
Non - VESA DFP 1.x Compatible

- (21) Maximum Horizontal Image Size = 340 mm
- (22) Maximum Vertical Image Size = 270 mm
- (23) Display Gamma = 2.20
- (24) Power Management and Supported Feature(s):
Active Off/Very Low Power, Standard Default Color Space,
Preferred Timing Mode
Display Type = R/G/B Color
- (25-34) CHROMA INFO:
Red X - 0.640 Green X - 0.290 Blue X - 0.140 White X - 0.310
Red Y - 0.340 Green Y - 0.610 Blue Y - 0.070 White Y - 0.330
- (35) ESTABLISHED TIMING I:
720 X 400 @ 70Hz (IBM,VGA)
640 X 480 @ 60Hz (IBM,VGA)
640 X 480 @ 67Hz (Apple,Mac II)
640 X 480 @ 72Hz (VESA)
640 X 480 @ 75Hz (VESA)
800 X 600 @ 56Hz (VESA)
800 X 600 @ 60Hz (VESA)
- (36) ESTABLISHED TIMING II:
800 X 600 @ 72Hz (VESA)
800 X 600 @ 75Hz (VESA)
832 X 624 @ 75Hz (Apple,Mac II)
1024 X 768 @ 60Hz (VESA)
1024 X 768 @ 70Hz (VESA)
1024 X 768 @ 75Hz (VESA)
1280 X 1024 @ 75Hz (VESA)
- (37) Manufacturer's Reserved Timing:
1152 X 870 @ 75Hz (Apple,Mac II)
- (38-53) Standard Timing Identification:
1280 X 1024 @60Hz
1024 X 768 @85Hz
800 X 600 @85Hz
640 X 480 @85Hz
640 X 400 @70Hz
Not Used
Not Used
Not Used

(54-71) Detailed Timing / Descriptor Block 1:
1280x1024 Pixel Clock: 108.00 MHz

Horizontal Image Size: 338 mm Vertical Image Size: 271 mm
Refreshed Mode: Non-Interlaced Normal Display - No Stereo

Horizontal:

Active Time: 1280 pixels Blanking Time: 408 pixels
Sync Offset: 48 pixels Sync Pulse Width: 112 pixels
Border: 0 pixels Frequency: 63.98 KHz

Vertical:

Active Time: 1024 lines Blanking Time: 42 lines
Sync Offset: 1 lines Sync Pulse Width: 3 lines
Border: 0 lines Frequency: 60.02 Hz

Digital Separate, Horizontal Polarity (+) Vertical Polarity (+)

(72-89) Detailed Timing / Descriptor Block 2:

Monitor Serial Number:
P3U040100001

(90-107) Detailed Timing / Descriptor Block 3:

Monitor Range Limits:
Min Vertical Freq - 50 Hz
Max Vertical Freq - 85 Hz
Min Horiz. Freq - 30 KHz
Max Horiz. Freq - 82 KHz
Pixel Clock - 140 MHz
Secondary GTF - Not Supported

(108-125) Detailed Timing / Descriptor Block 4:

Monitor Name:
VG712/b

(126) No Extension EDID Block(s)

(127) CheckSum OK

3. Front Panel Function Control Description

Adjusting the Screen Image

Use the buttons on the front control panel to display and adjust the OnView® controls which display on the screen. The OnView controls are explained at the top of the next page.

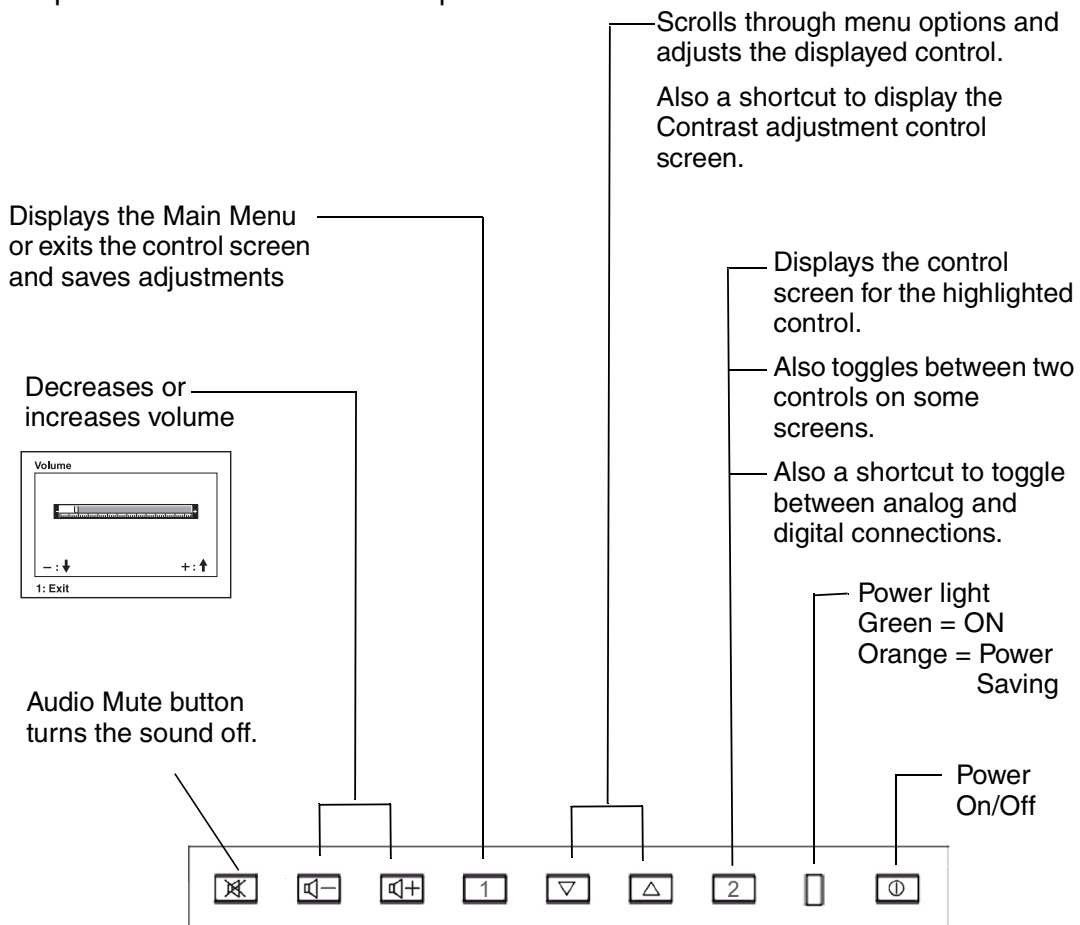
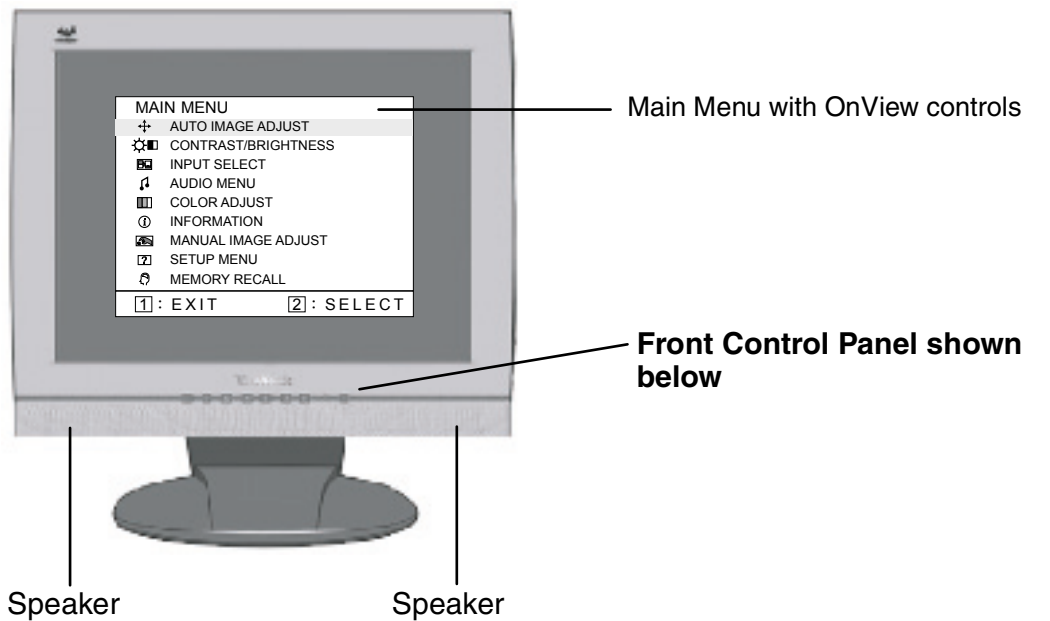

Do the following to adjust the screen image:

- 1 To display the Main Menu, press button [1].

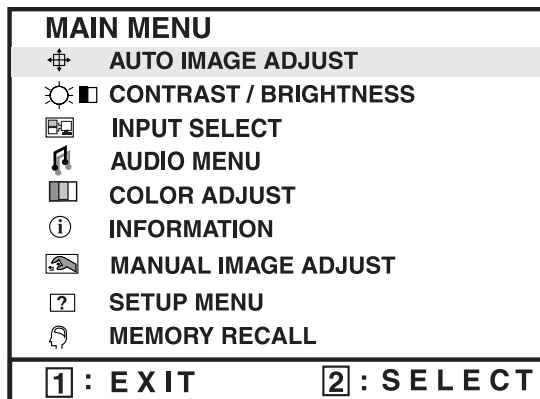

NOTE: All OnView menus and adjustment screens disappear automatically after about 15 seconds. This is adjustable through the OSD timeout setting in the setup menu.

- 2 To select a control you want to adjust, press ▲ or ▼ to scroll up or down the Main Menu.
- 3 After the control is selected, press button [2]. A control screen like the one shown below appears.

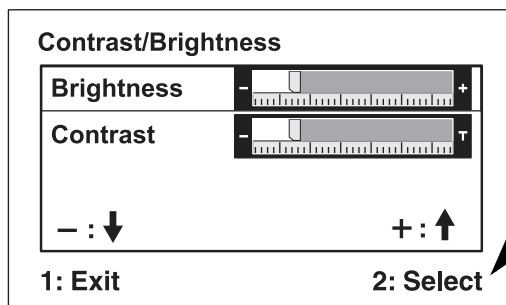

The command line at the bottom of the control screen tells what to do next from this screen. You can toggle between control screens, adjust the selected option, or exit the screen.

- 4 To adjust the control, press the up ▲ or down ▼ buttons.
- 5 To save the adjustments and exit the menu, press button [1] *twice*.

The following tips may help you optimize your display:

- Adjust your computer's graphic card so that it outputs a video signal 1280 x 1024 @ 60Hz to the LCD display. (Look for instructions on "changing the refresh rate" in your graphic card's user guide.)
- If necessary, make small adjustments using H POSITION and V POSITION until the screen image is completely visible. (The black border around the edge of the screen should barely touch the illuminated "active area" of the LCD display.)

Main Menu Controls

Adjust the menu items shown below by using the up ▲ and down ▼ buttons.

Control Explanation



Auto Image Adjust sizes and centers the screen image automatically.



Contrast adjusts the difference between the image background (black level) and the foreground (white level).



Brightness adjusts background black level of the screen image.



Input Select toggles between inputs if you have more than one computer.

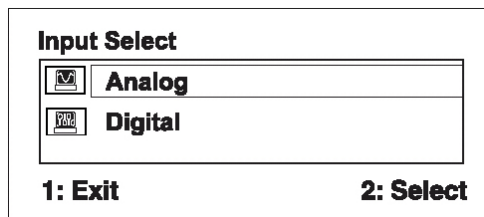

Audio Adjust

Volume increases the volume, decreases the volume, and mutes the audio.

Mute temporarily silences audio output.



Color Adjust provides several color adjustment modes: preset color temperatures and **RGB** which allows you to adjust red (**R**), green (**G**), and blue (**B**) separately. The factory setting for this product is 6500K (6500 Kelvin).

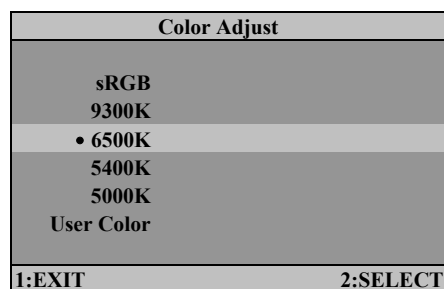

sRGB — sRGB is quickly becoming the industry standard for color management, with support being included in many of the latest applications. Enabling this setting allows the LCD display to more accurately display colors the way they were originally intended. Enabling the sRGB setting will cause the Contrast and Brightness adjustments to be disabled.

9300K — Adds blue to the screen image for cooler white (used in most office settings with fluorescent lighting).

6500K — Adds red to the screen image for warmer white and richer red.

5400K — Adds green to the screen image for a darker color.

5000K — Adds blue and green to the screen image for a darker

Control Explanation

User Color— Individual adjustments for red (R), green (G), and blue (B).

- 1 To select color (R, G or B) press button [2].
- 2 To adjust selected color, press ▲ or ▼.

Important: If you select RECALL from the Main Menu when the product is set to a Preset Timing Mode, colors return to the 6500K factory preset.



Information displays the timing mode (video signal input) coming from the graphics card in your computer, the LCD model number, the serial number, and the ViewSonic website URL. See your graphic card's user guide for instructions on changing the resolution and refresh rate (vertical frequency).

NOTE: VESA 1280 x 1024 @ 60Hz (recommended) means that the resolution is 1280 x 1024 and the refresh rate is 60 Hertz.

Information:		
H. Frequency:	XX	kHz
V. Frequency:	XX	Hz
Resolution	XXXXXXXXXX	
Pixel Clock:	XXX	MHz
Serial Number:	XXXXXXXXXXXXXX	
Model Number:	XXXXXXXXXXXXXX	
www.ViewSonic.com		1: Exit



Manual Image Adjust Sub-menu

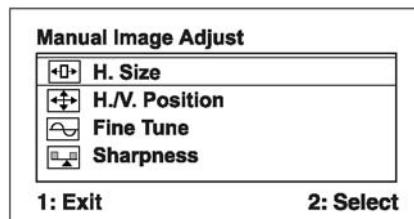

H. Size (Horizontal Size) adjusts the width of the screen image.



H./V. Position (Horizontal/Vertical Position) moves the screen image left or right and up or down.

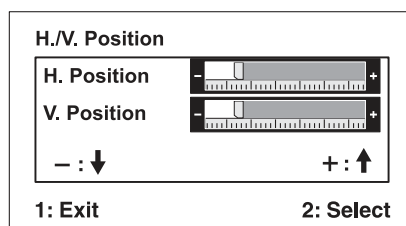

Control	Explanation
---------	-------------



OSD Position allows you to move the on-screen display menus and control screens.



OSD Timeout sets the length of time the on-screen display screen is displayed. For example, with a “30 second” setting, if a control is not pushed within 30 seconds, the display screen disappears.



OSD Background On/Off allows you to turn the On-Screen Display background On or Off.



Memory Recall returns the adjustments back to factory settings if the display is operating in a factory Preset Timing Mode listed in the Specifications of this manual.

Hot Keys for Function Controls

Buttons:	Functions:
[Up] + [Down] arrows	Recall <i>Contrast</i> or <i>Brightness</i> while in the <i>Contrast</i> or <i>Brightness</i> adjustment, or recall both of <i>Contrast</i> and <i>Brightness</i> when the OSD is not on.
[Volume-] + [Volume+]	Recall <i>volume</i> to 50% while in <i>volume</i> adjustment, or when OSD is not on.
[1] + [2]	Toggle 720x400 and 640x400 mode when input 720x400 or 640x400 mode.
[1] + [Up] + [Down]	<i>White Balance</i> . <i>White Balance</i> should set the screen on the pure black and white pattern with 640*480@60Hz resolution.
[1] + [Down] (hold for 10 seconds)	<i>Power Lock (Unlock)</i> . User won't be able to turn off the monitor.
[1] + [Up] (hold for 10 seconds)	<i>OSD Lock (Unlock)</i> . It will lock all functions, including "Volume" and "Mute".
[Up] + [Down] + [Power On] with signal (Hold for 3 seconds. Release "Power" button first and then "Up" & "Down" buttons.)	<i>All Mode Reset</i> . It will erase all end users' settings and restore the factory defaults.
[Up] + [Down] + [Power On] Without signal (Hold for 3 seconds. Release "Power" button first and then "Up" & "Down" buttons.)	<i>Burn in Mode</i> . After entering <i>Burn in Mode</i> , press [1] button, you can find the information about this monitor.

Remark: All the shortcut functions are only available while OSD is off.

4. Circuit Description

1. Power supply (DC/DC Converter)

The AP1501 is monolithic IC designed for M/B DC/DC converter, and owns the ability of driving a 3A load without any additional transistor component.

The AP1501 operates at a switching frequency of 150KHz and thus allows smaller-sized filter components than what would be needed with lower frequency switch regulator.

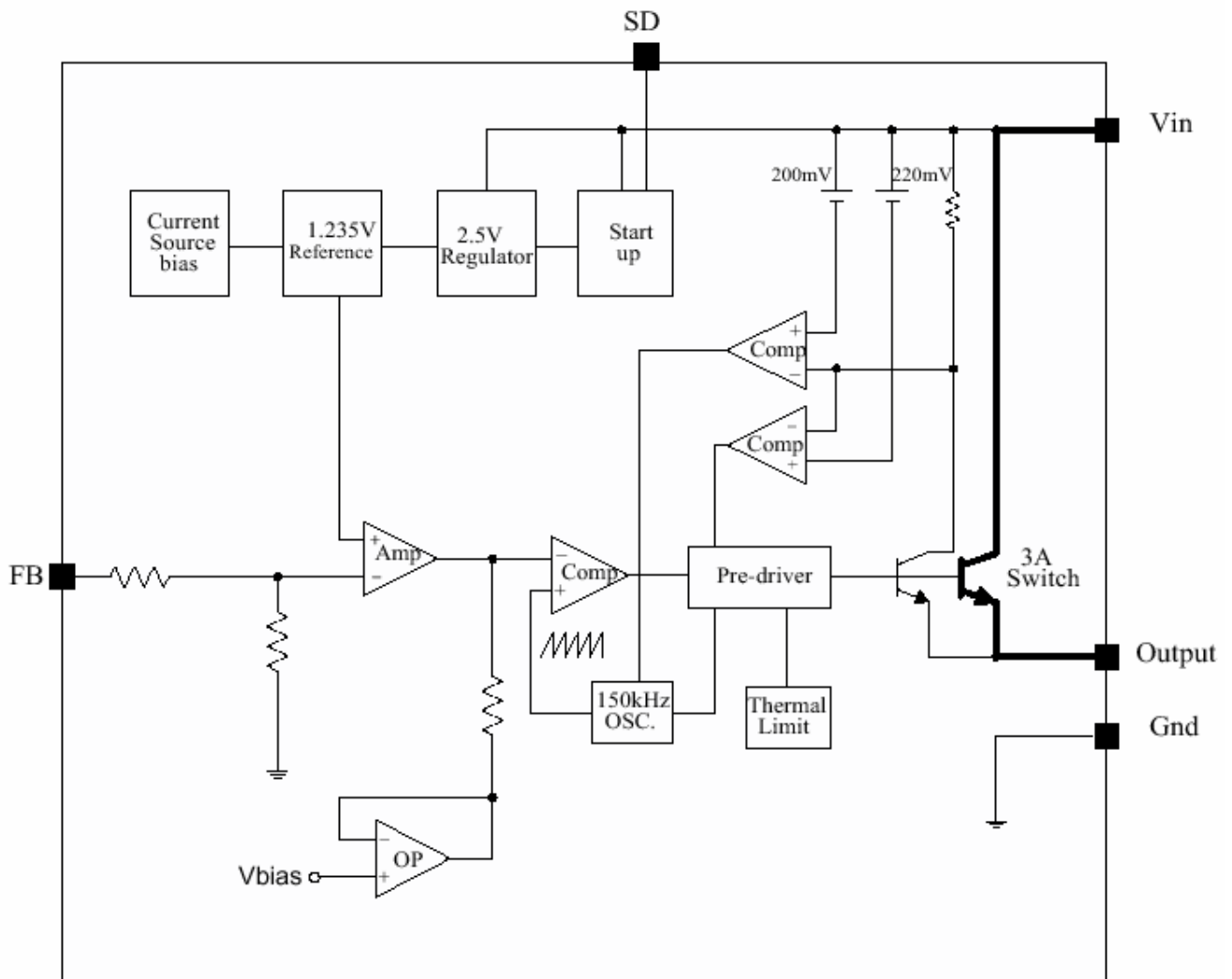

2. Flash Memory

The Pm39LV010R is a 1 Megabit, 3.3 Volt-only Flash Memory organized as 131,072 bytes of 8 bits each. This device is designed to use a 3.0 Volt to 3.6 Volt power supply to perform in-system programming.

The 1 Megabit memory array is divided into thirty-two uniform blocks of 4 Kbytes each for data and/or code storage.

The block architecture allows users to flexibly make chip erase or block erase operation. The block erase feature allows a particular block to be erased and reprogrammed without affecting the data in other blocks. After the device performs chip erase or block erase operation, it can be reprogrammed on a byte-by-byte basis.

LOGIC SYMBOL

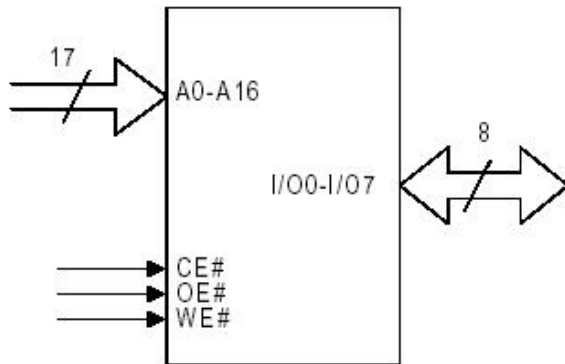

3. GM5120

The gm5110/20 is a graphic processing IC for Liquid Crystal Display (LCD) monitors at XGA/SXGA resolution. It provides all key IC functions required for the highest quality LCD monitors. On-chip functions include a high-speed triple-ADC and PLL, Ultra-Reliable DVI™ receiver, a high quality zoom and shrink scaling engine, an on-screen display (OSD) controller, digital color controls and an on-chip microcontroller (OCM). With this level of integration, the gm5110/20 devices simplify and reduce the cost of LCD monitors while maintaining a high-degree of flexibility and quality.

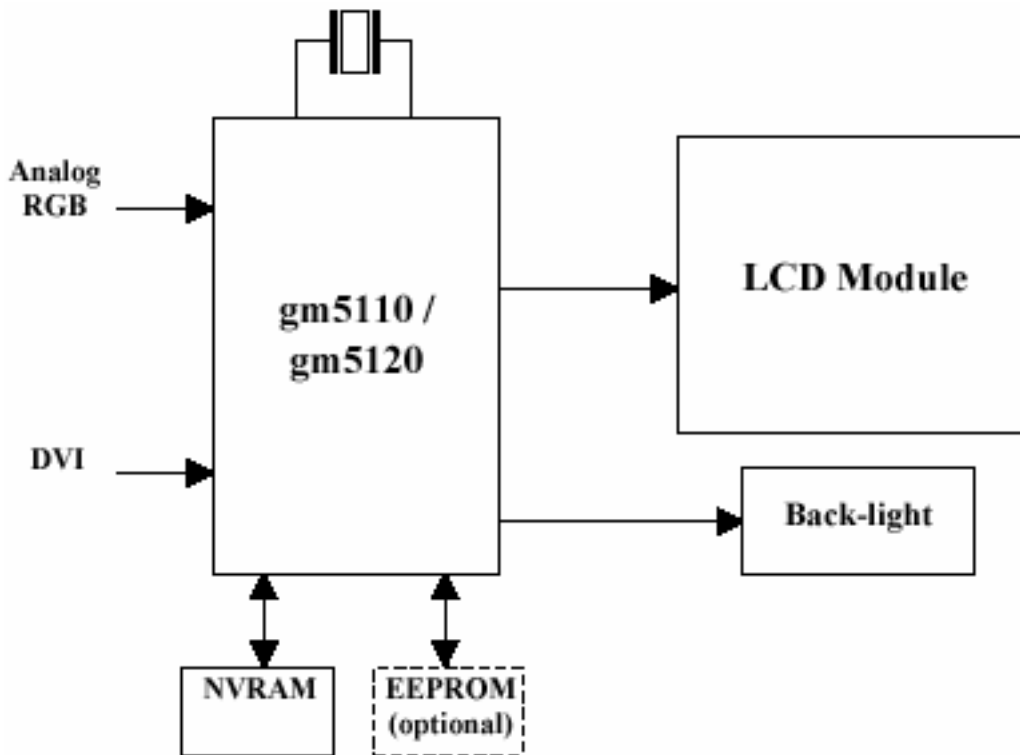

gm5110/5120 System Design Example

4. LVDS (THC63LVDM83A)

The THC63LVDM83A transmitter converts 28 bits of CMOS/TTL data into LVDS (Low Voltage Differential Signaling) data stream. A phase-locked transmit clock is transmitted in parallel with the data streams over a fifth LVDS link. The HC63LVDM83A can be programmed for rising edge or falling edge clocks through a dedicated pin. The THC63LVDF84A receiver converts the LVDS data streams back into 28 bits of CMOS/TTL data with falling edge clock. At a transmit clock frequency of 85MHz, 24 bits of RGB data and 4 bits of LCD timing and control data (HSYNC, VSYNC, CNTL1, CNTL2) are transmitted at a rate of 595 Mbps per LVDS data channel.

5. Adjusting Procedure

1. Function Test

1.1 Product

- 17" LCD Monitor

1.2 Test Equipment

- Color Video Signal & Pattern (or PC with SXGA resolution and a sound card)

1.3 Test Condition

Before function test and alignment, each LCD Monitor should be run-in and warmed up for at least 30 minutes with the following conditions:

- (a) In room temperature,
- (b) With full-white screen, RGB, and Black
- (c) With cycled display modes,

640*480 (H=43.27KHz, V=85Hz)

800*600 (H=53.7KHz, V=85Hz)

1024*768 (H=68.67KHz, V=85Hz)

1280*1024 (H=79.97KHz, V=75Hz)

1.4 Test Display Modes & Pattern

1.4.1 Compatible Modes

	Analog	Digital
1.	640 x 350 @ 70Hz, 31.5KHz	640 x 350 @ 70Hz, 31.5KHz
2.	640 x 400 @ 60Hz, 31.5KHz	640 x 400 @ 60Hz, 31.5KHz
3.	640 x 400 @ 70Hz, 31.5KHz	640 x 400 @ 70Hz, 31.5KHz
4.	640 x 480 @ 50Hz, 24.7KHz	640 x 480 @ 50Hz, 24.7KHz
5.	640 x 480 @ 60Hz, 31.5KHz	640 x 480 @ 60Hz, 31.5KHz
6.	640 x 480 @ 67Hz, 35.0KHz	640 x 480 @ 67Hz, 35.0KHz
7.	640 x 480 @ 72Hz, 37.9KHz	640 x 480 @ 72Hz, 37.9KHz
8.	640 x 480 @ 75Hz, 37.5KHz	640 x 480 @ 75Hz, 37.5KHz
9.	640 x 480 @ 85Hz, 43.27KHz	640 x 480 @ 85Hz, 43.27KHz
10.	720 x 400 @ 70Hz, 31.5KHz	720 x 400 @ 70Hz, 31.5KHz
11.	800 x 600 @ 56Hz, 35.1KHz	800 x 600 @ 56Hz, 35.1KHz
12.	800 x 600 @ 60Hz, 37.9KHz	800 x 600 @ 60Hz, 37.9KHz
13.	800 x 600 @ 75Hz, 46.9KHz	800 x 600 @ 75Hz, 46.9KHz
14.	800 x 600 @ 72Hz, 48.1KHz	800 x 600 @ 72Hz, 48.1KHz
15.	800 x 600 @ 85Hz, 53.7KHz	800 x 600 @ 85Hz, 53.7KHz

16.	832 x 624 @ 75Hz, 49.7KHz	832 x 624 @ 75Hz, 49.7KHz
17.	1024 x 768 @ 60Hz, 48.4KHz	1024 x 768 @ 60Hz, 48.4KHz
18.	1024 x 768 @ 70Hz, 56.5KHz	1024 x 768 @ 70Hz, 56.5KHz
19.	1024 x 768 @ 72Hz, 58.1KHz	1024 x 768 @ 72Hz, 58.1KHz
20.	1024 x 768 @ 75Hz, 60.0KHz	1024 x 768 @ 75Hz, 60.0KHz
21.	1024 x 768 @ 85Hz, 68.67KHz	1024 x 768 @ 85Hz, 68.67KHz
22.	1152 x 864 @ 75Hz, 67.5KHz	1152 x 864 @ 75Hz, 67.5KHz
23.	1152 x 870 @ 75Hz, 68.7KHz	1152 x 870 @ 75Hz, 68.7KHz
24.	1280 x 1024 @ 60Hz, 63.4KHz	1280 x 1024 @ 60Hz, 63.4KHz
25.	1280 x 1024 @ 75Hz, 79.97KHz	1280 x 1024 @ 75Hz, 79.97KHz
26.	1280x 720 @ 60Hz, 45KHz (HDTV)	1280x 720 @ 60Hz, 45KHz (HDTV)

1.4.2 Function Test Display Pattern

Item	Test Content	Pattern	Specification	Remark
1	Frequency & Tracking	Fine Line Moire	Eliminate visual wavy noise.	Figure 1
2	Contrast/Brightness	16 Gray Scale	16 gray levels should be distinguishable.	Figure 2
3	Boundary	Horizontal & Vertical Thickness	Horizontal and Vertical position of video should be adjustable to be within the screen frame.	Figure 3
4	RGB Color Performance	RGB Color Intensities	Contrast of each R, G, B, color should be normal.	Figure 4, 5, 6
5	Screen Uniformity & Flicker	Full White	Should be compliant with the spec.	Figure 7
6	Dead Pixel/Line	White Screen & Dark Screen	The numbers of dead pixels should be compliant with the spec.	Figure 7, 8
7	White Balance	White & Black Pattern	The screen must have the pure white and black pattern, no other color.	Figure 9



Fine Line Morie Pattern (Figure1)



Gray Scale Pattern (Figure2)



Horizontal & Vertical Thickness Pattern (Figure 3)



R. Color Pattern (Figure 4)



G. Color Pattern (Figure 5)

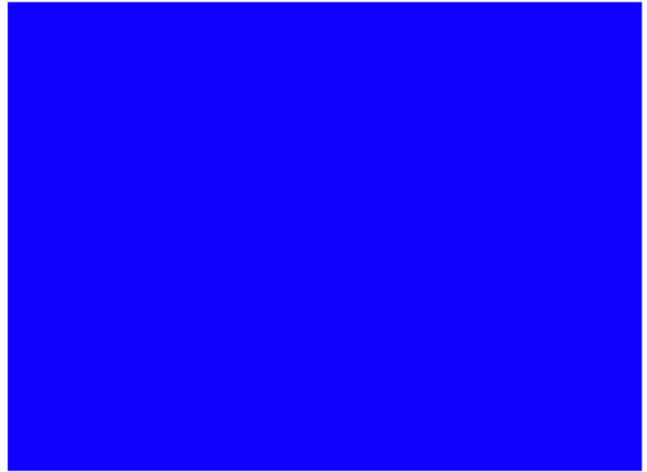

B. Color Pattern (Figure 6)



Full White Patter (Figure 7)

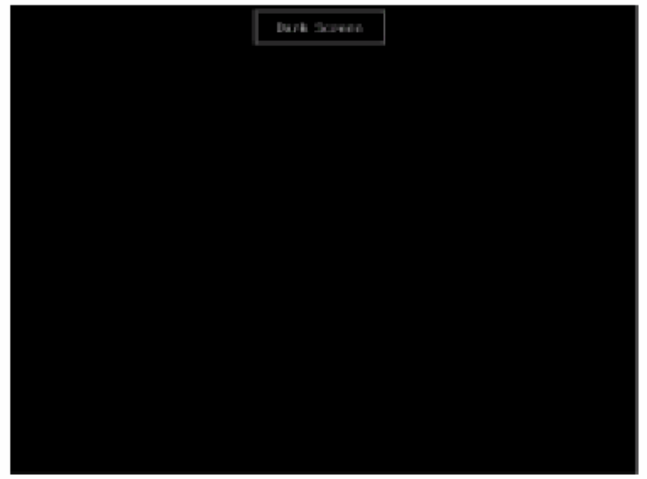

Dark Screen Pattern (Figure 8)

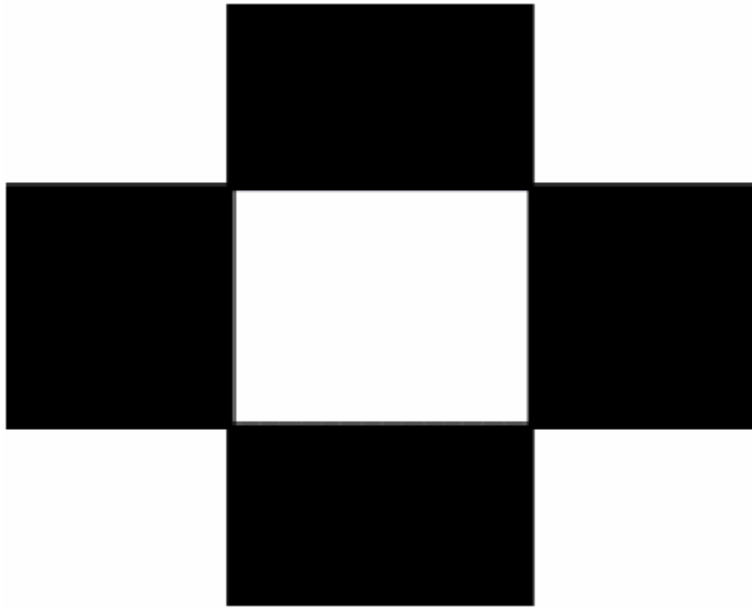

Black-White Pattern (Figure 9)

1.5 Function Test and Alignment Procedure

1.5.1 All Modes Reset

You should do “All Mode Reset” (Refer to Chapter III-3. Hot Keys for Function Controls) first. This action will allow you to erase all end-user’s settings and restore the factory defaults.

1.5.2 Auto Image Adjust

Please select and enter “*Auto Image Adjust*” function on Main Menu to see if it is workable. The “*Auto Image Adjust*” function is aimed to offer a better screen quality by built-in ASIC. For optimum screen quality, the user has to adjust each function manually.

1.5.3 Firmware

Test Pattern: Burn In Mode (Refer to Chapter III-3. Hot Keys for Function Controls)

- Make sure the F/W is the latest version.

1.5.4 DDC

Test Pattern: EDID program

- Make sure it can pass test program.

1.5.5 Fine Tune and Sharpness

Test Signal: 1280*1024@60Hz

Test Pattern: Line Moire Pattern

- Check and see if the image has noise and focus performs well. Eliminate visual line bar.
- If not, readjust by the following steps:
 - (a) Select and enter “**Fine Tune**” function on “**Manual Image Adjust**” to adjust the image to eliminate visual wavy noise.
 - (b) Then, select and enter “**Sharpness**” function to adjust the clarity and focus of the screen image.

1.5.6 Boundary

Test Signal: 1280*1024@60Hz

Test Pattern: Horizontal & Vertical Line Thickness Pattern

- Check and see if the image boundary is within the screen frame.
- If not, readjust by the following steps:
 - (a) Select and enter “**Manual Image Adjust**” function on OSD Main Menu.
 - (b) Then, select and enter “**Horizontal Size**” or “**Horizontal/Vertical Position**” function to adjust the video boundary to be full scanned and within screen frame.

1.5.7 White Balance

Test Signal: 640*480@60Hz

Test Pattern: White and Black Pattern

1.5.8 R, G, B, Colors Contrast

Test Signal: 1280*1024@60Hz

Test Pattern: R, G, B, Color Intensities Pattern and 16 Gray Scale Pattern

- Check and see if each color is normal and distinguishable.
- If not, please return the unit to repair area.

1.5.9 Screen Uniformity and Flicker

Test Signal: 1280*1024@60Hz

Test Pattern: Full White Pattern

- Check and see if it is in normal condition.

1.5.10 Dead Pixel and Line

Test Signal: 1280*1024@60Hz

Test Pattern: Dark and White Screen Pattern

- Check and see if there are dead pixels on LCD panel with shadow gauge and filter film.
- The total numbers and distance of dead pixels should be compliant with the spec.

1.5.11 Mura

Test Pattern: White, RGB, Black, & Grey

Test Tool: 8% ND Filter

- Check if the Mura can pass 8% ND Filter.

1.5.12 Audio

Test Signal: Voice signal (optional, depend on model)

Test Pattern: liberty

- Make sure there is audio output.
- Make sure that audio function (volume 80%) is working without noise and resonance.
- Make sure that the sound of right and left speakers are in balance.

1.5.13 Check for Secondary Display Modes

Test Signal:

Analog: 640 x 350 @ 70Hz; 640 x 400 @ 60Hz; 640 x 400 @ 70Hz;

640 x 480 @ 50/60/67/72/75/85Hz; 720 x 400 @ 70Hz; 800 x 600 @ 56/60/72/75/85Hz; 832 x 624 @ 75Hz; 1024 x 768 @ 60Hz; 1024 x 768 @ 70/72/75/85Hz; 1152 x 864 @ 75Hz; 1152 x 870 @ 75Hz; 1280 x 1024 @ 75Hz; 1280x 720 @ 60Hz (HDTV).

Digital: 640 x 350 @ 70Hz; 640 x 400 @ 60/70/Hz; 640 x 480 @ 50/60/67/72/75/85Hz; 720 x 400 @ 70Hz; 800 x 600 @ 56/60/75/72/85Hz; 832 x 624 @ 75Hz; 1024 x 768 @ 60/70/72/75/85Hz; 1152 x 864 @ 75Hz; 1152 x 870 @ 75Hz; 1280 x 1024 @ 75Hz; 1280x 720 @ 60Hz (HDTV).

- Normally when the primary mode 1280*1024@60Hz is well adjusted and compliant with the specification, the secondary display modes will be great possible to be compliant with the spec. But we still have to check with the general test pattern to make sure every secondary is compliant with the specification.

1.5.14 All Modes Reset

After final QC step, we have to erase all saved changes again and restore the factory defaults. You should do "All Mode Reset" again.

1.5.15 Power Off Monitor

Turn off the monitor by pressing "Power" button.

2. Firmware Upgrade Procedure

When you receive the returned monitor, please check whether the firmware version is the latest.

If not, please do the following procedures to upgrade it to the latest version.

2.1 Equipment Needed

- VG712s/b Monitor
- Fixture for Firmware Upgrade
- Power Adapter (P/N: 47.58201.001) *1 for Fixture
- VGA Cable (P/N: 42.59901.003) *1(Pin 4, 11 should be connected to GND)
- PC (Personal Computer)
- LPT Cable (P/N: 42.59906.001) *1
- Firmware Upgrade Program
- One additional monitor for checking the program execution

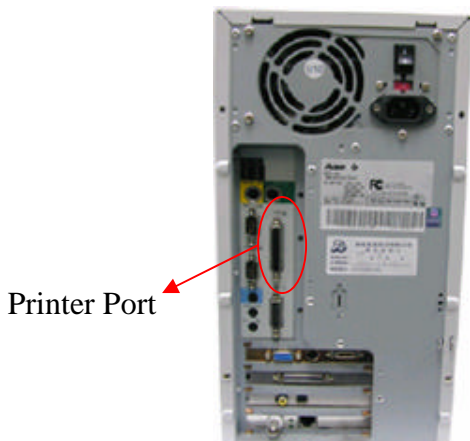

Printer Port

PC

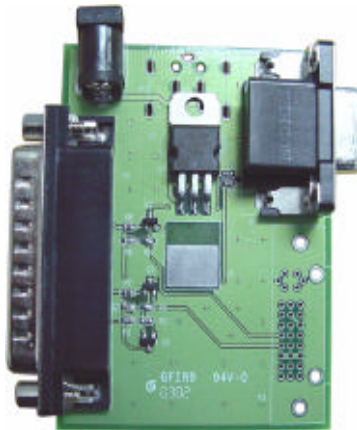

Fixture



VG712S



Power Adapter for Fixture
(P/N: 47.58201.001)

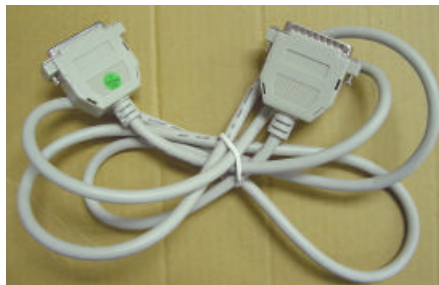

LPT Cable
(P/N: 42.59906.001)



VGA Cable
(P/N: 42.59901.003)

2.2 Setup Procedure

- 2.2.1 Connect P2 of Fixture with printer port of PC by LPT Cable.
- 2.2.2 Connect P1 of Fixture with VG712 Monitor by VGA Cable.
- 2.2.3 Plug Power Adapter to Fixture.
- 2.2.4 Connect Power Cord to VG712 Monitor.
- 2.2.5 Connect PC to the additional monitor.

JP1: to Power Adapter

P2: to LPT Cable

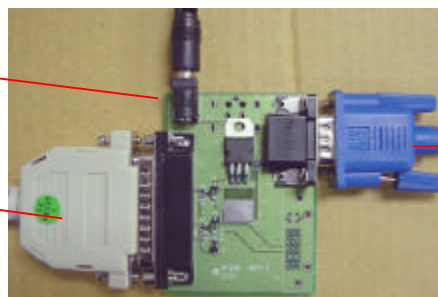

P1: to VGA Cable

2.2.6 Install GProbe Program by selecting and clicking Gprobe icon. Press “Yes” or “Next” buttons until the installation is complete.

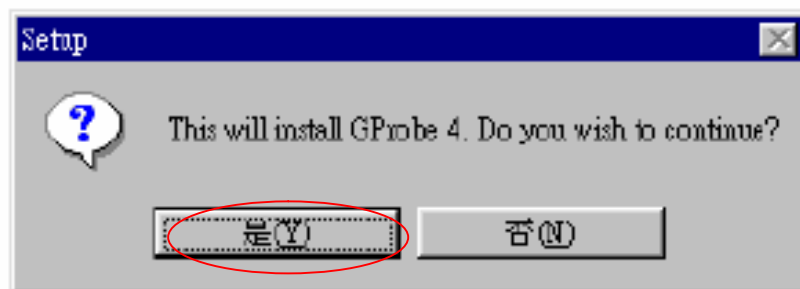
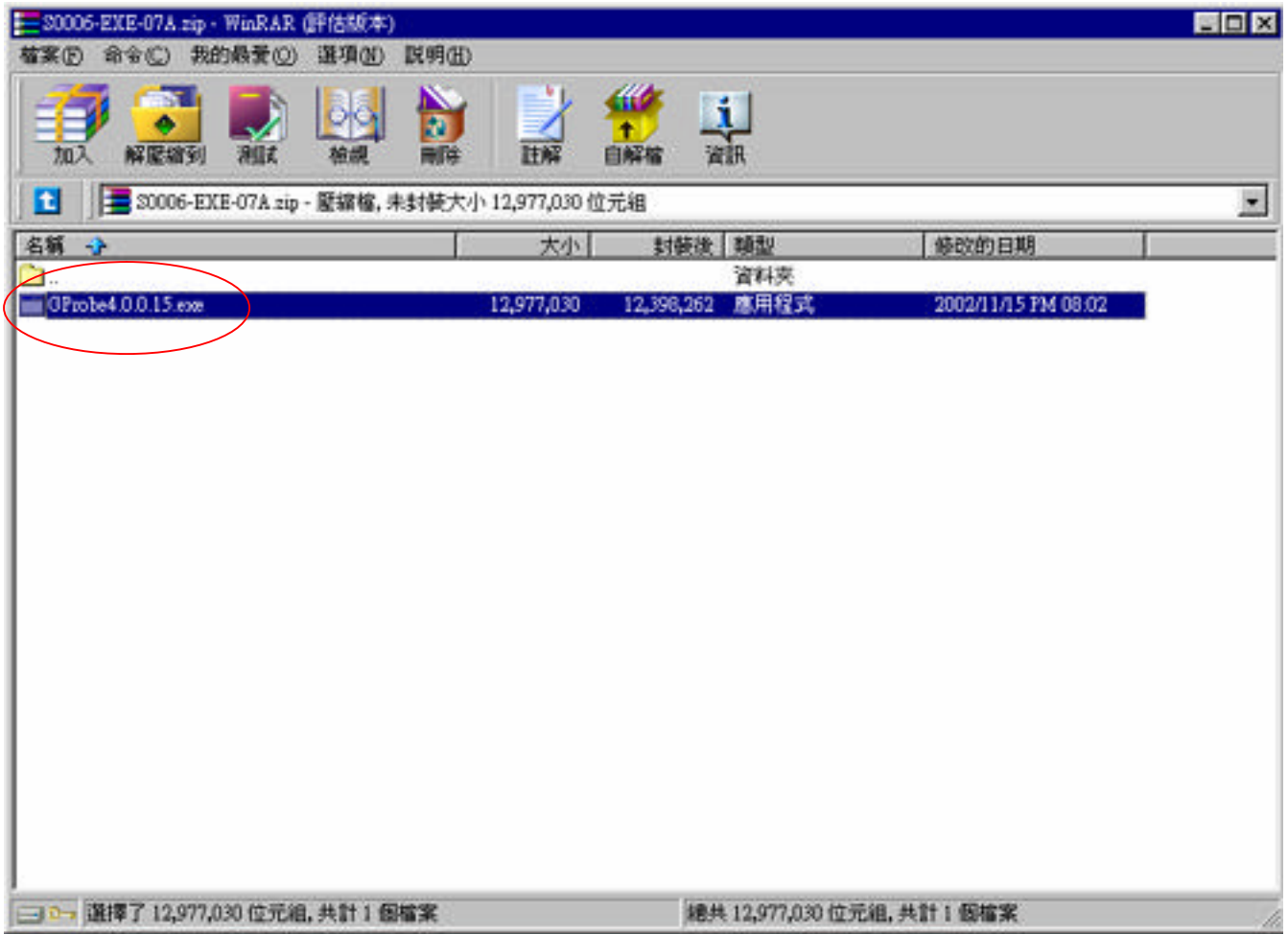

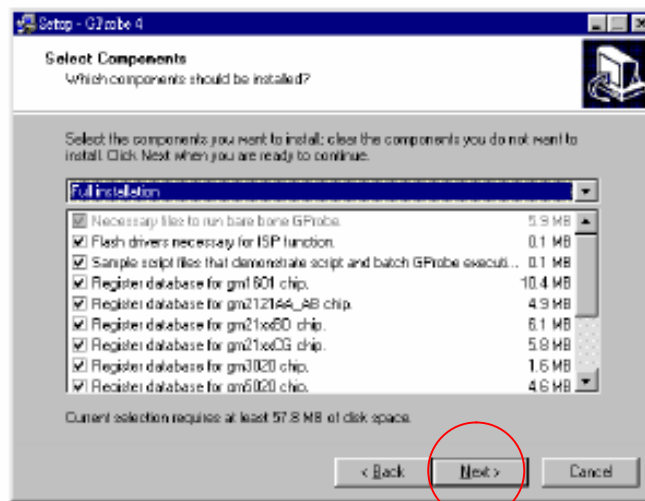
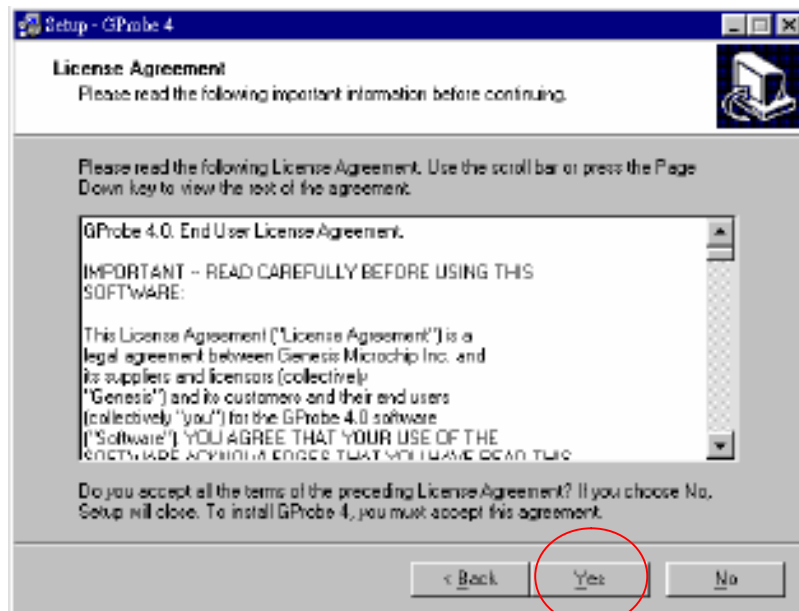
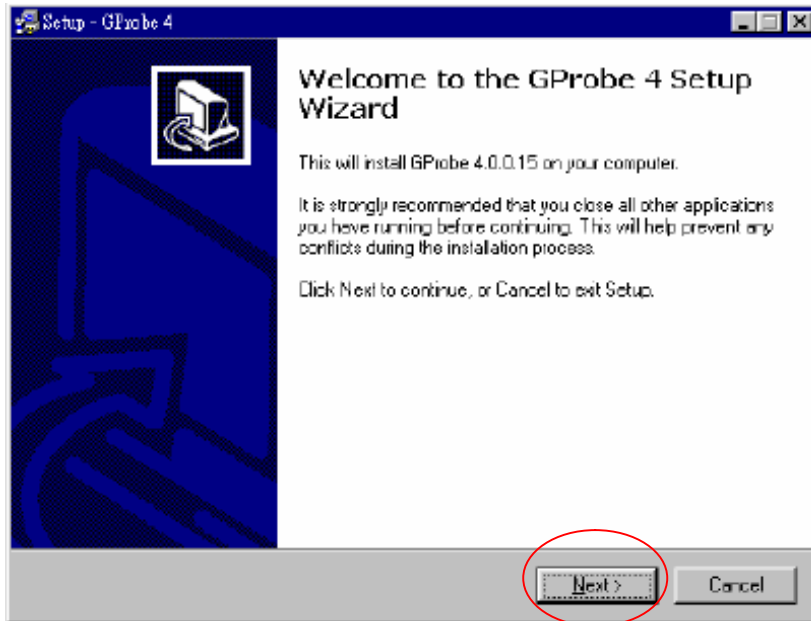

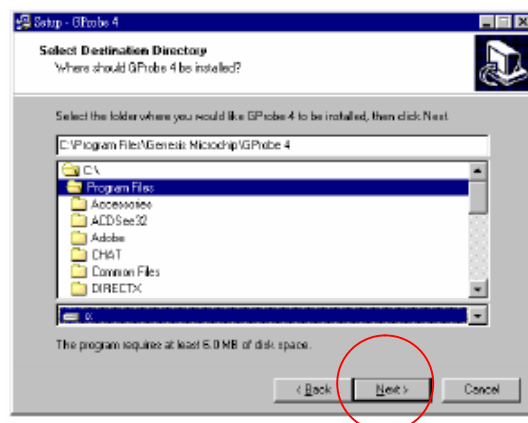
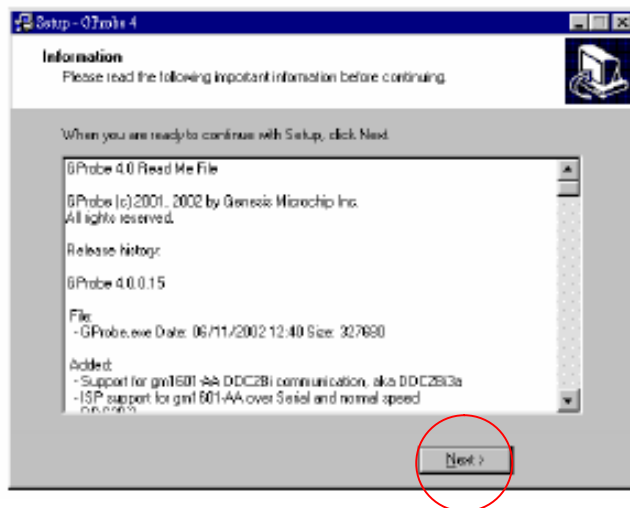
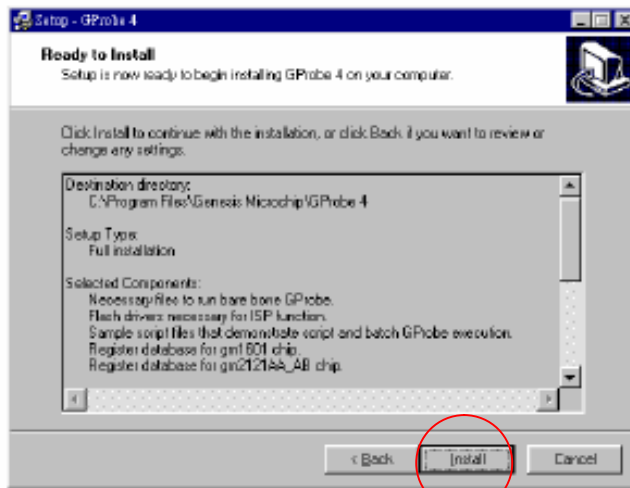

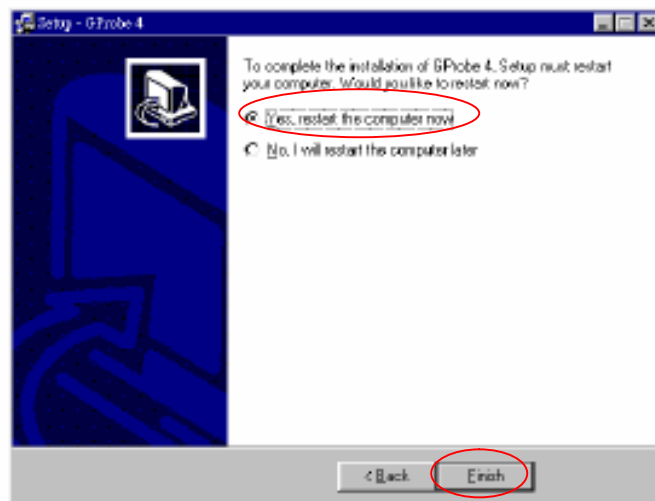
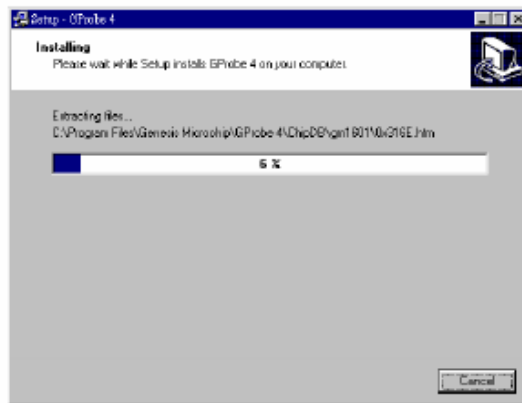
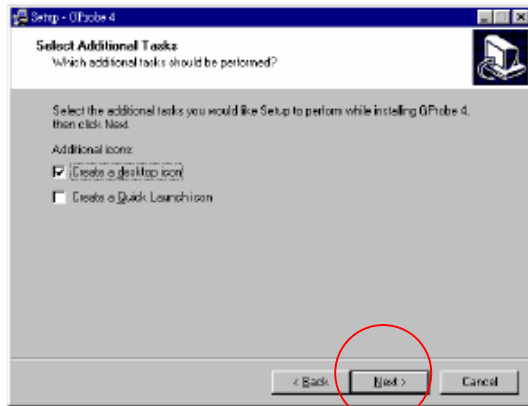

2.3 Firmware Upgrade Procedure

Step 1. Let VG712 enter Burn In Mode. (Refer to Chapter III-3. Hot Keys for Function Controls).

Step 2. Save these three files<bdisp.txt>, <p204_205.bin> and <712AV_V2_65.bin> in a hard disk (better in a root directory, e.g. C:\ or D:\).

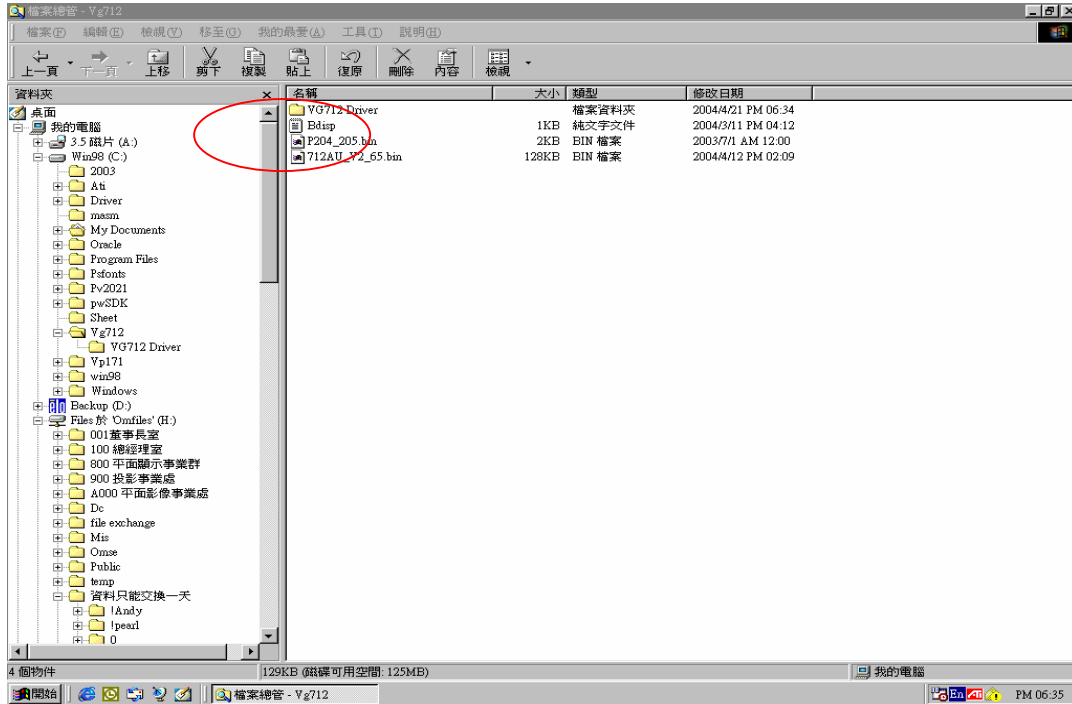

Step 3. Open <bdisp.txt> file. Key in the path where you save the driver <p204_205.bin> and firmware <712AV_V2_65.bin >.

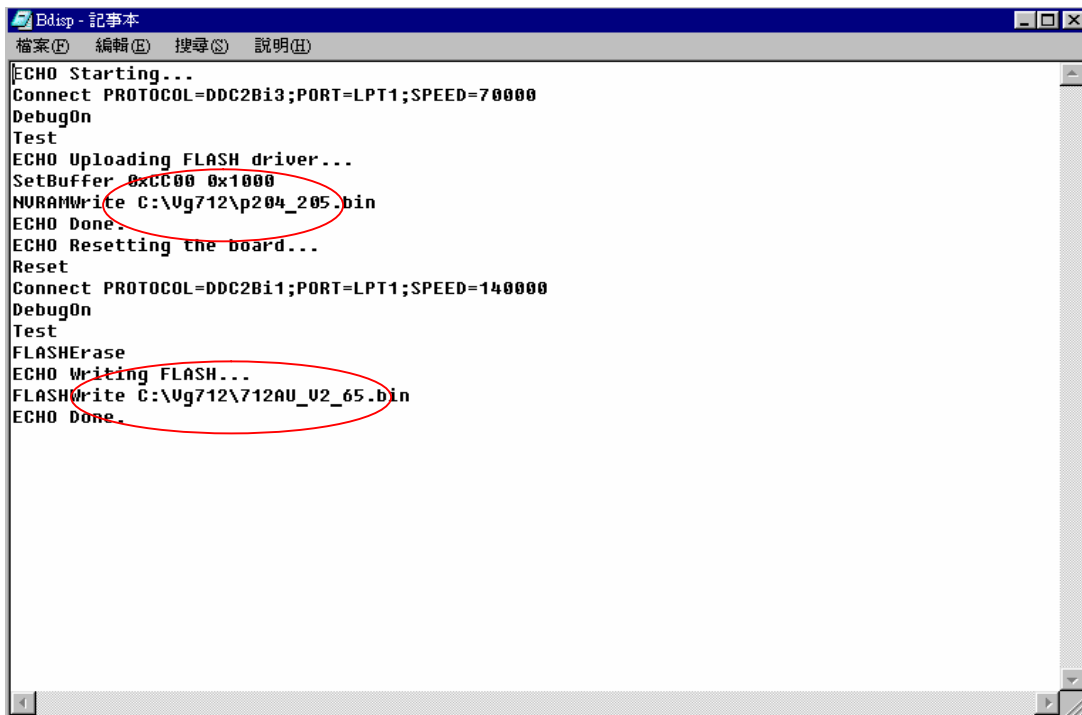

Step 4. Execute Gprobe program.

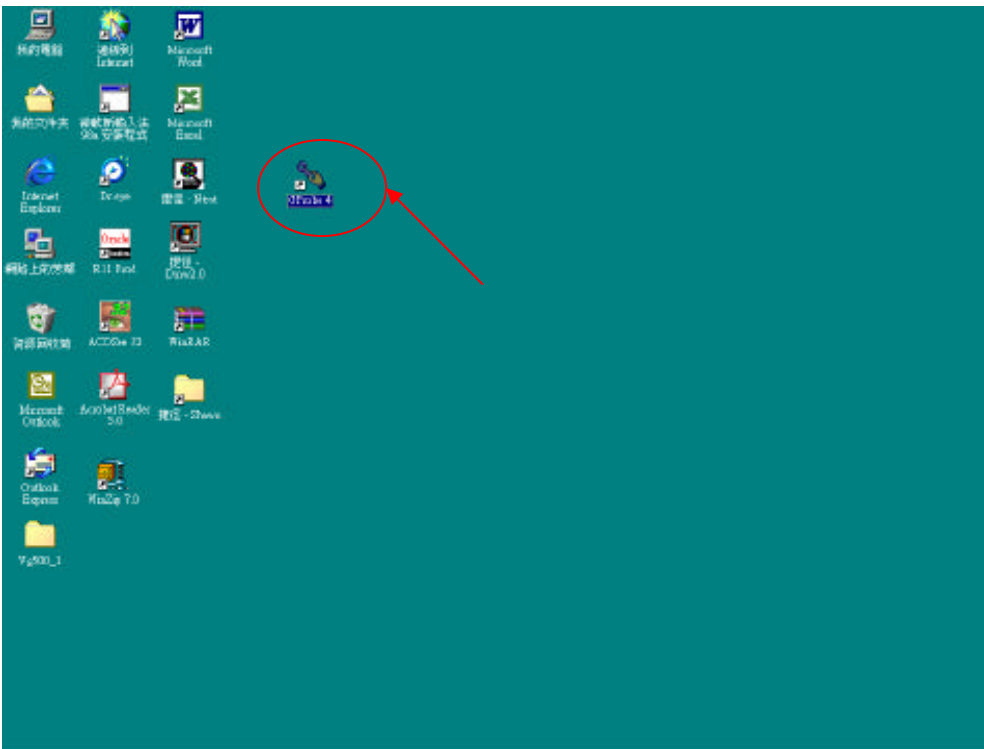

Step 5. Click Connection Setup icon. Select Protocol: DDC 2Bi3, Port: LPT1 (0x378), Speed: 70000.

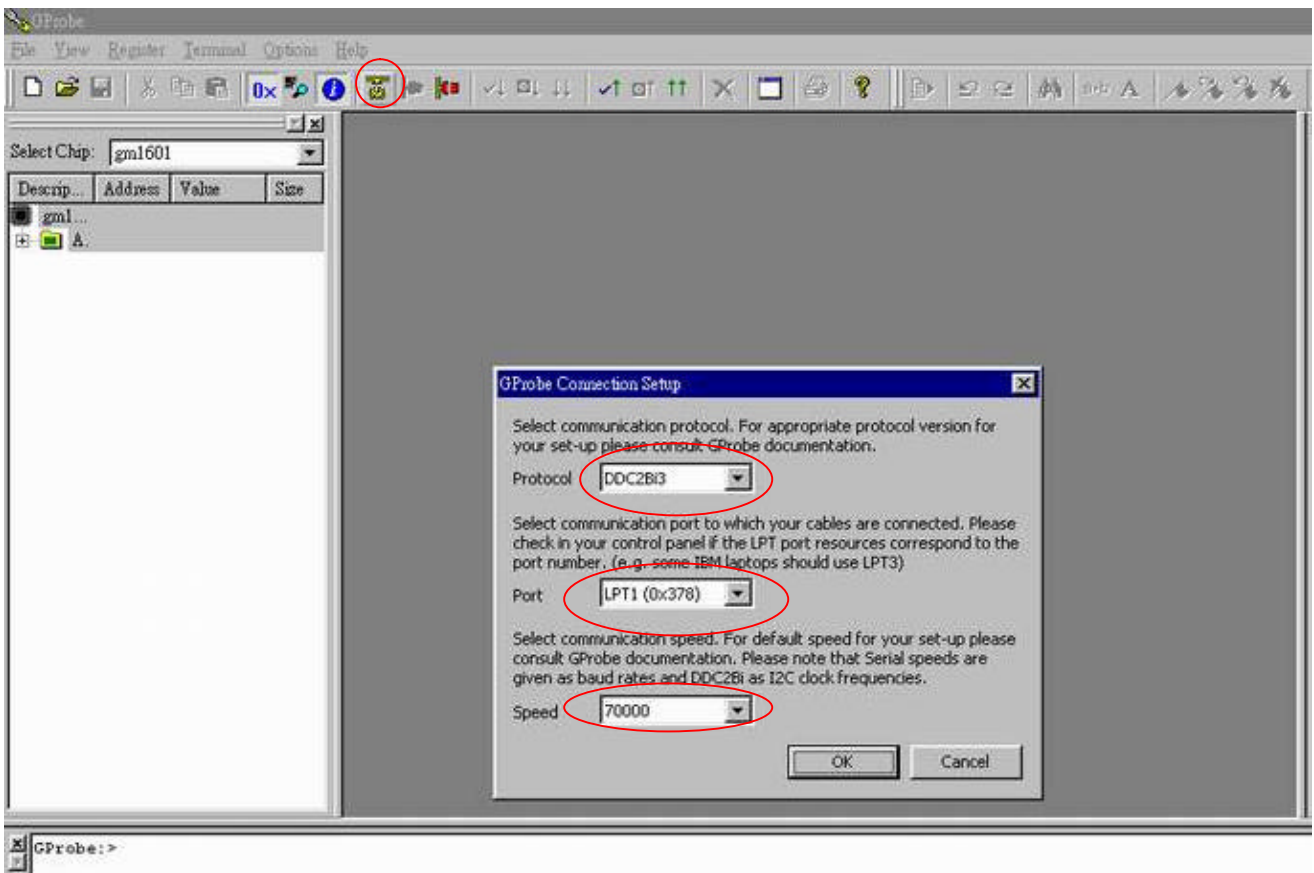

Step 6. Before executing the firmware program, please test the connection between the monitor and fixtures. Key in “test” after “Gprobe,” and then press “Enter.”

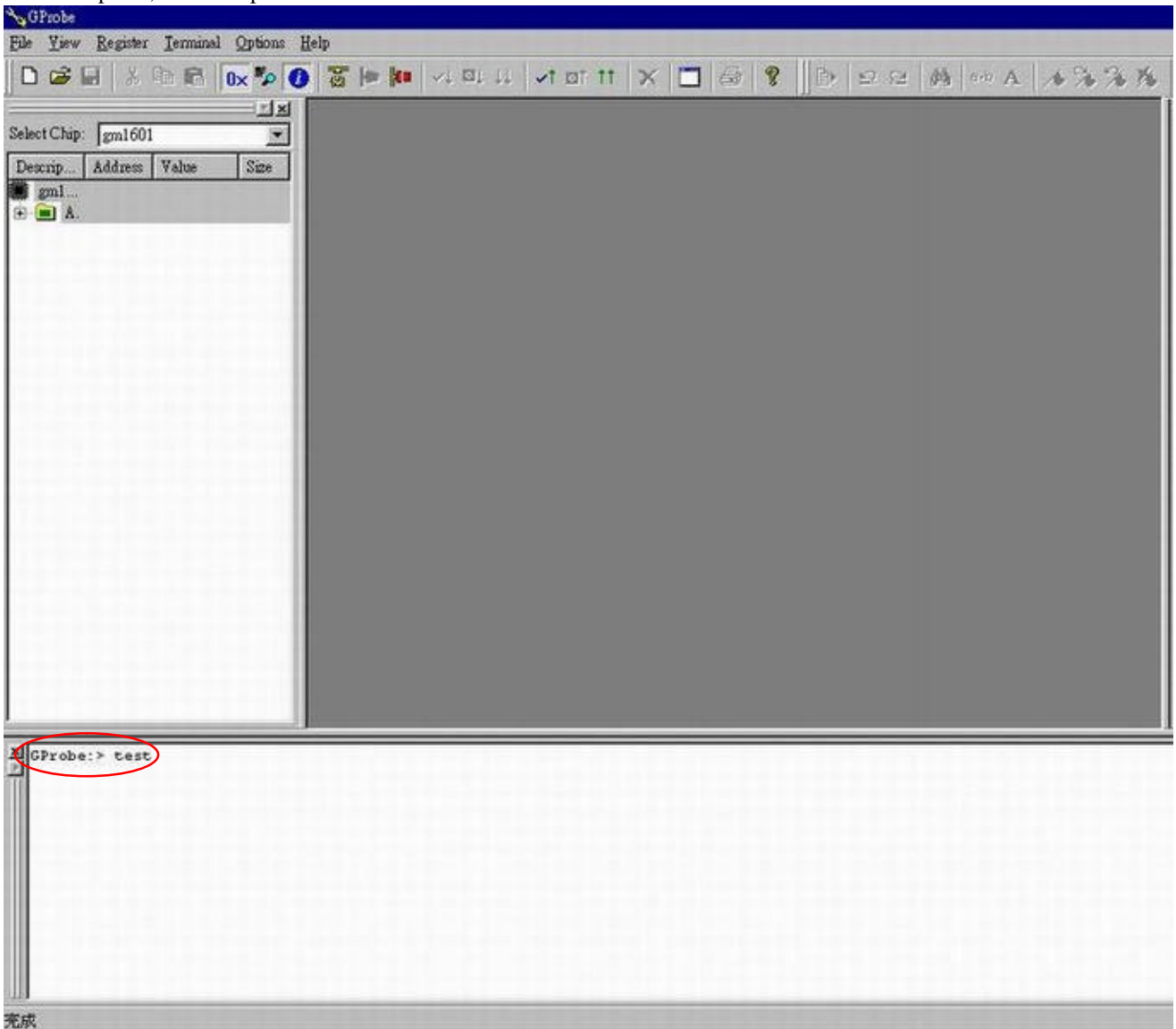

If the test result shows “passed,” it means the connection is well. If not (failed), it means the connection has problems. Then you need to check the setup procedure or reboot the PC, or simply use another PC to do the firmware upgrade.

Step 7. Key in “batch C:\VG712\bdisp.txt” after “Gprobe:”, and then press “Enter” key to begin programming.

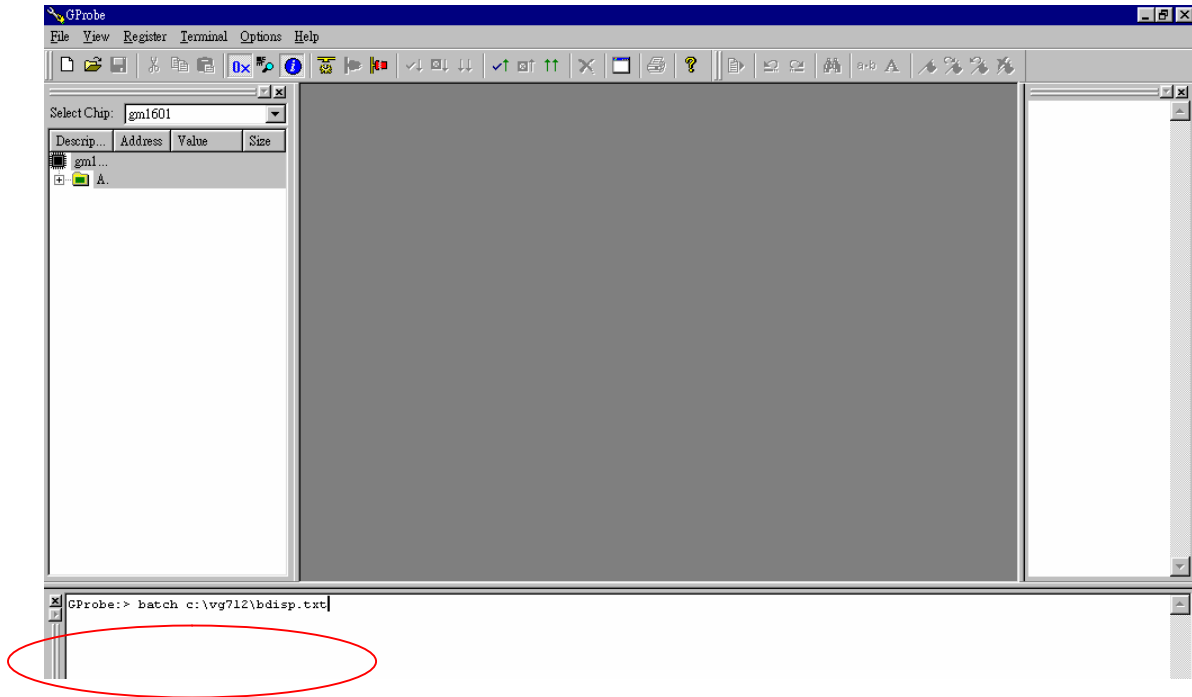

Step 8. The successful picture is as follows:

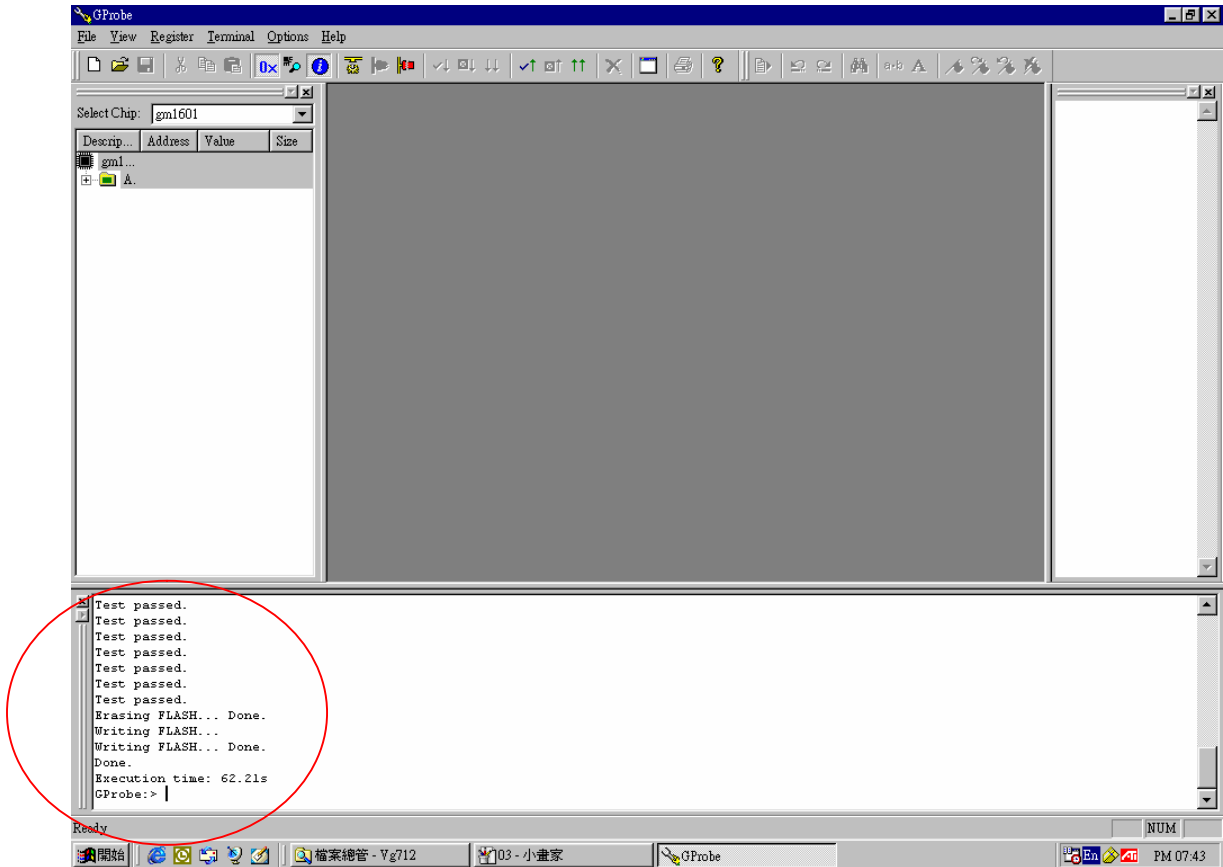

Step 9. Unplug and replug power cord of VG712s/b and then enter “Burn In Mode” (Refer to Chapter III-3. Hot Keys for Function Controls). Check if the version of BIOS is correct.

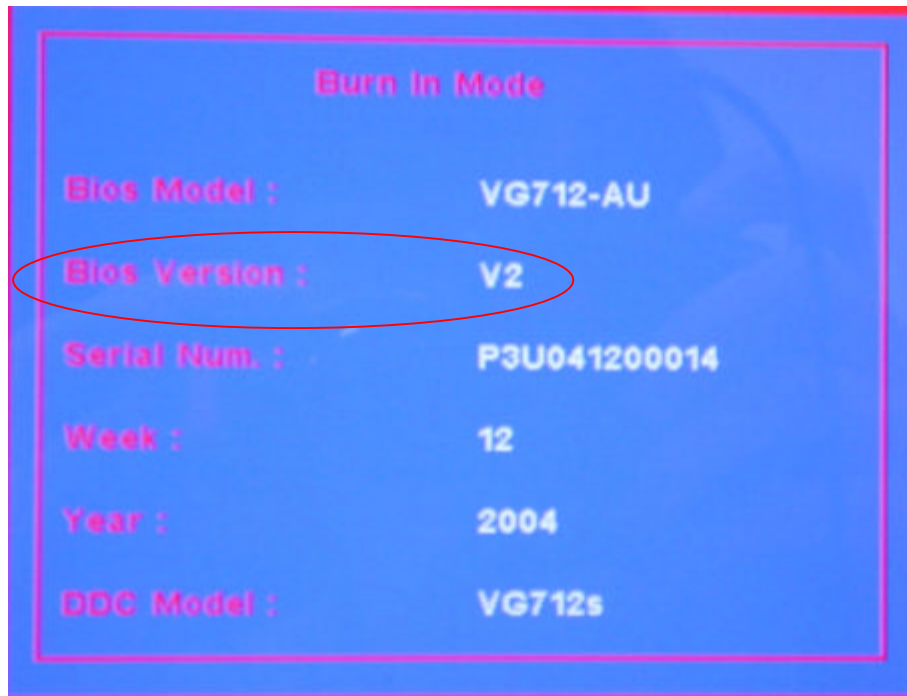

Step 10. At last, do “All Mode Reset.”

Troubleshooting:

1. If the firmware upgrade fails at the last step, **don't unplug the power cord of the monitor**. Just try the upgrade procedure again.
 - (a) If there is error to execute the command at or before line10 in the “bdisp.txt” batch file (for instance, the message “Error executing batch file at line 4” shows up in the Gprobe program (see the following picture)), please try to upgrade the firmware again.

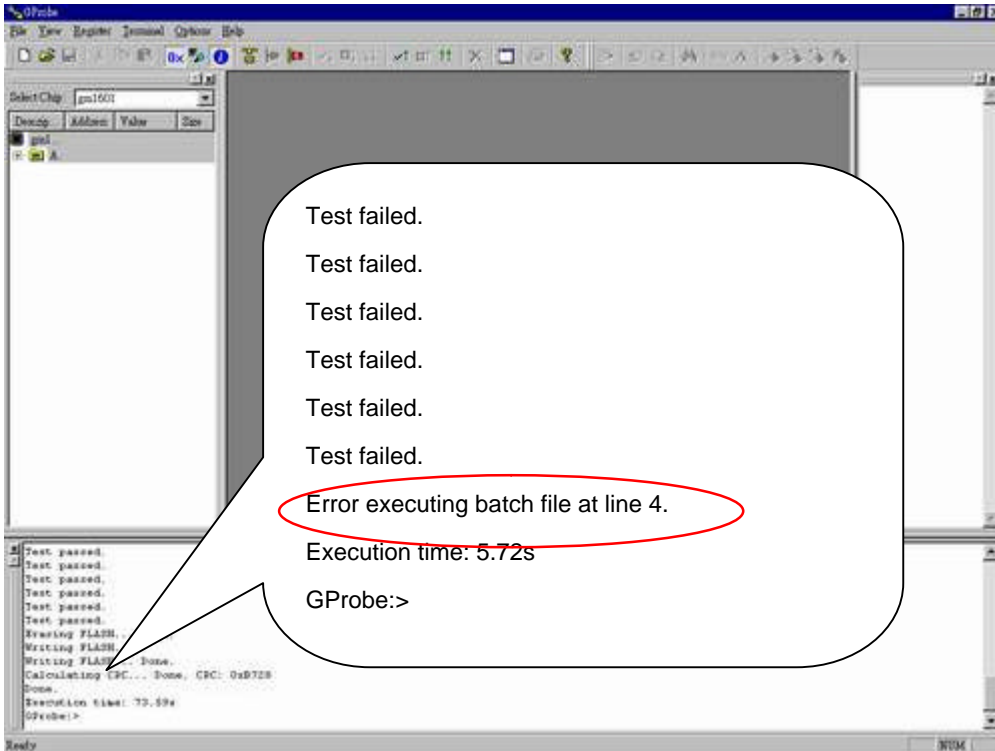

- (b) If there is error to execute the command at or after line11 in the “bdisp.txt” batch file, please copy the error line of the “bdisp.txt” batch file to “Gprobe:>” in the Gprobe program, and then press “Enter.” For example, there is “Error executing batch file at line 16” (see the following picture). Then you have to copy line 16 “FLASHWRITE C:\VG712\712AV_V2_65.bin” in the “bdisp.txt” file to “Gprobe:>” in the Gprobe program, and then press “Enter” (see the picture next page).

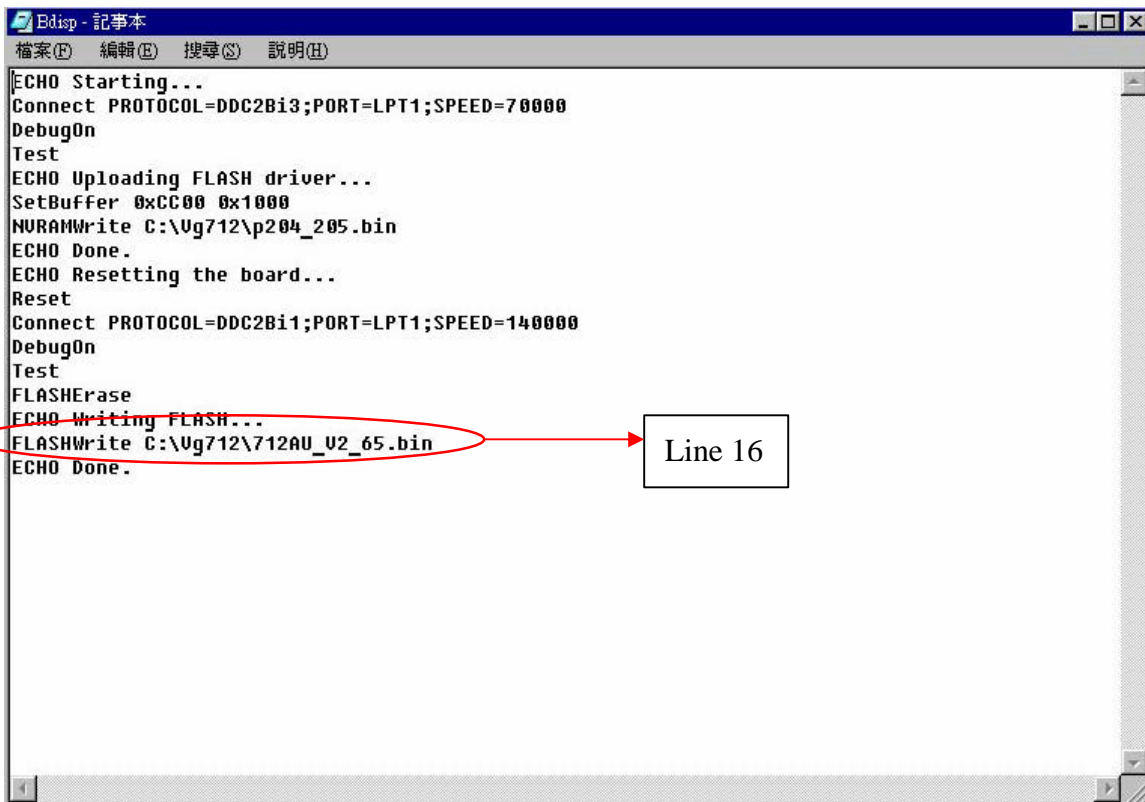
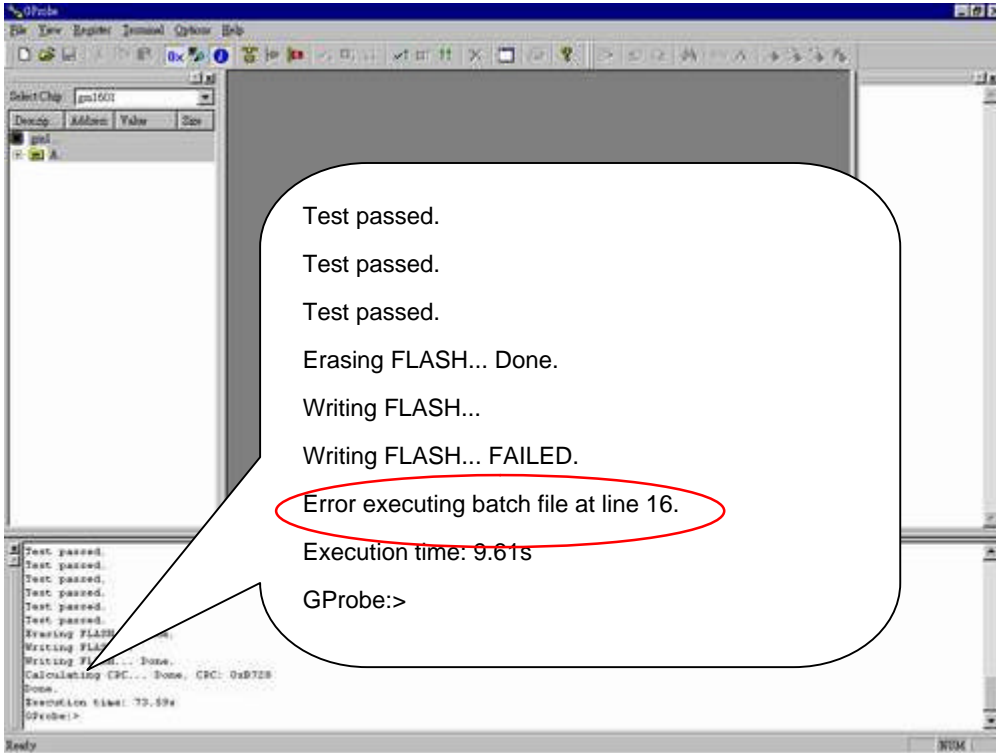

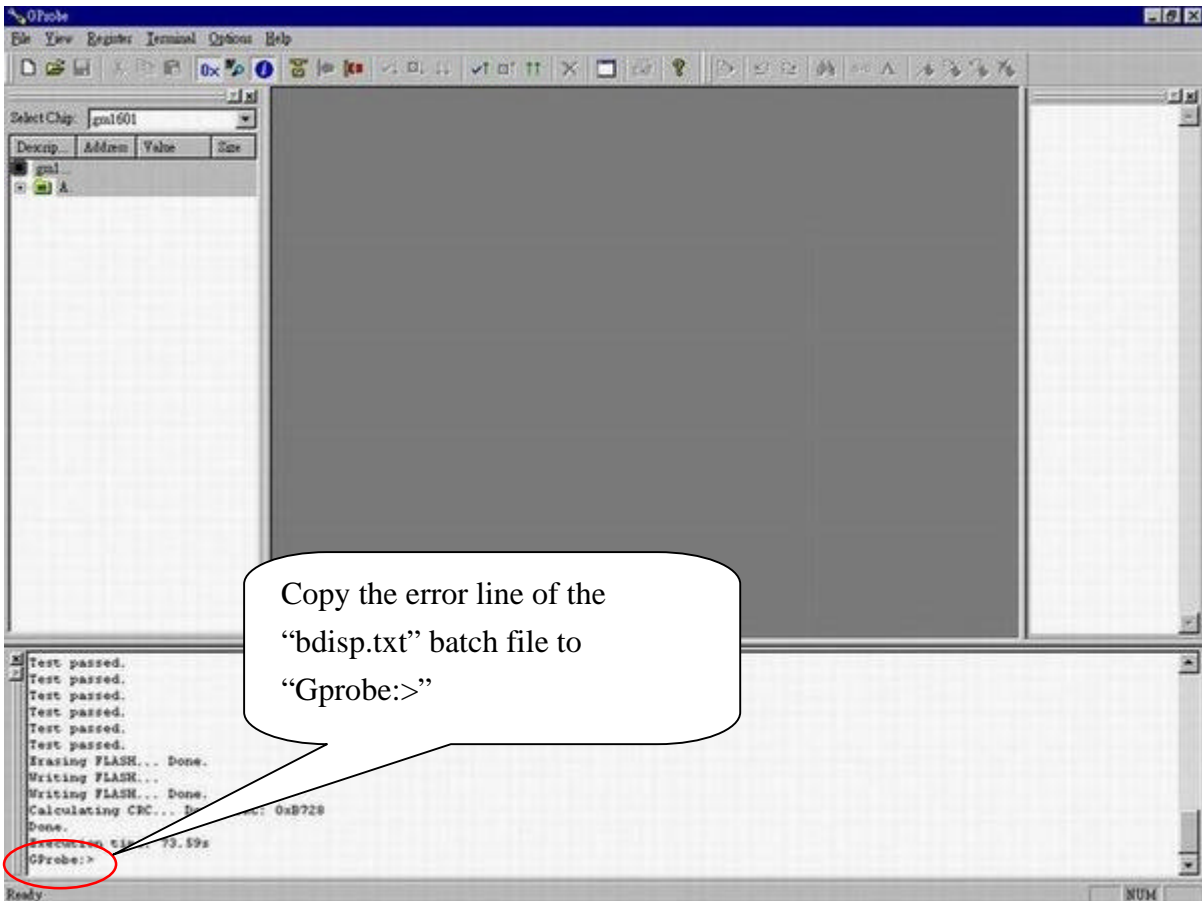

2. If the firmware upgrade still fails, reboot the PC, or simply use another PC to upgrade.
3. If the above procedures don't work, unplug and re-plug the power cord of VG712s/b. Then try to upgrade the firmware again if VG712 can be powered on. **If VG712s/b cannot be turned on, that means the flash memory of the main board is out of work.** You then have to replace the main board.

3. DDC Key In Procedure

Note:

1. Every time after replacing the main board, you have to do the DDC key in.
2. If you find the DDC does not conform to the monitor, you have to do the DDC key in.

3.1 Equipment Needed

- VG712s/b Series Monitor
- Fixture (V3) for DDC Key in (JP3 must be closed)
- RS232 Cable (P/N: 42.55907.001) *1
- VGA Cable (P/N: 42.59901.003) *2
- DVI-DVI Cable *1 (P/N: 42.56108.012)

- PC (Personal Computer) with Win 98
- Power Adapter (P/N: 47.56001.501) *1 for Fixture
- DDC Key In Program
- One additional monitor for checking the program execution



COM1:
to
RS232
Cable

PC

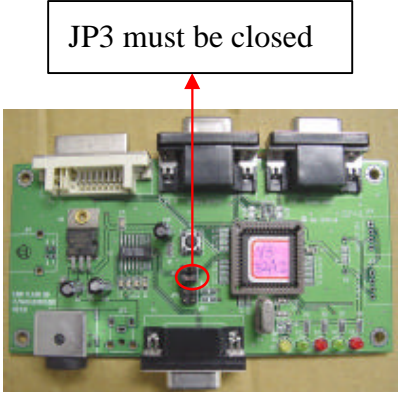

JP3 must be closed

V3 Fixture



VG712S



RS-232 Cable
(P/N: 42.55907.001)



DVI-DVI Cable
(P/N: 42.56108.012)



Power Adapter for Fixture
(P/N: 47.57702.001)



Barcode Reader



VGA Cable (P/N: 42.59901.003)

3.2 Setup Procedure

- 3.2.1 Connect P2 of Fixture with VGA port of VG712s/b by VGA Cable.
- 3.2.2 Connect P3 of Fixture with DVI port of VG712s/b by DVI-DVI Cable.
- 3.2.3 Connect P1 of Fixture with **COM1** of PC by RS-232 Cable.
- 3.2.4 Plug Power Adapter to Fixture(JP1).
- 3.2.5 Connect Power Cord to VG712s/b Monitor.
- 3.2.6 Connect PC to the additional monitor.

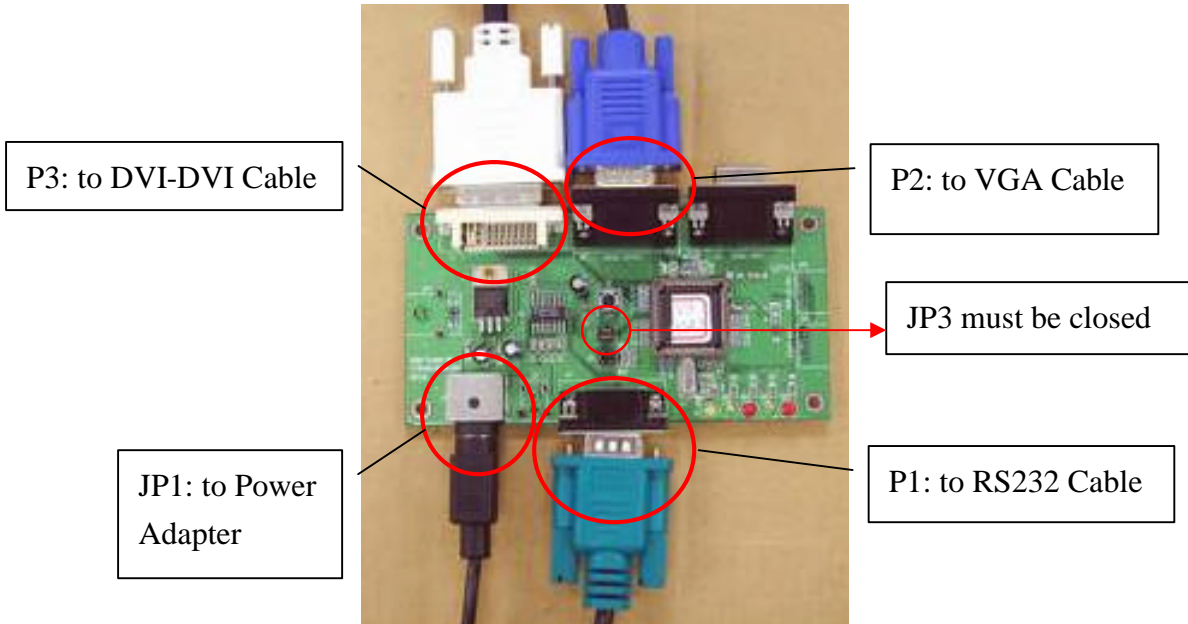

3.3 DDC Key In Procedure

Step 1. Select and execute DDC Key In program.

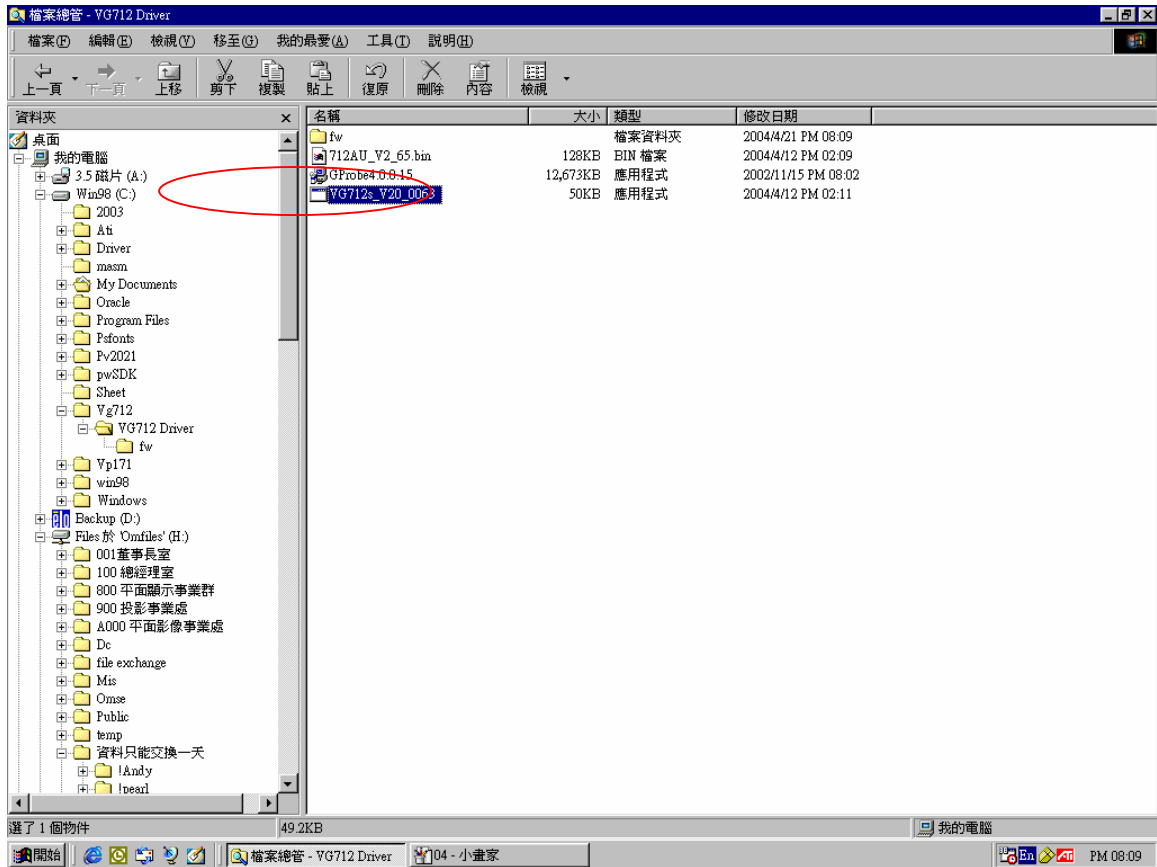

Step 2. Select "W/w - writing mode."

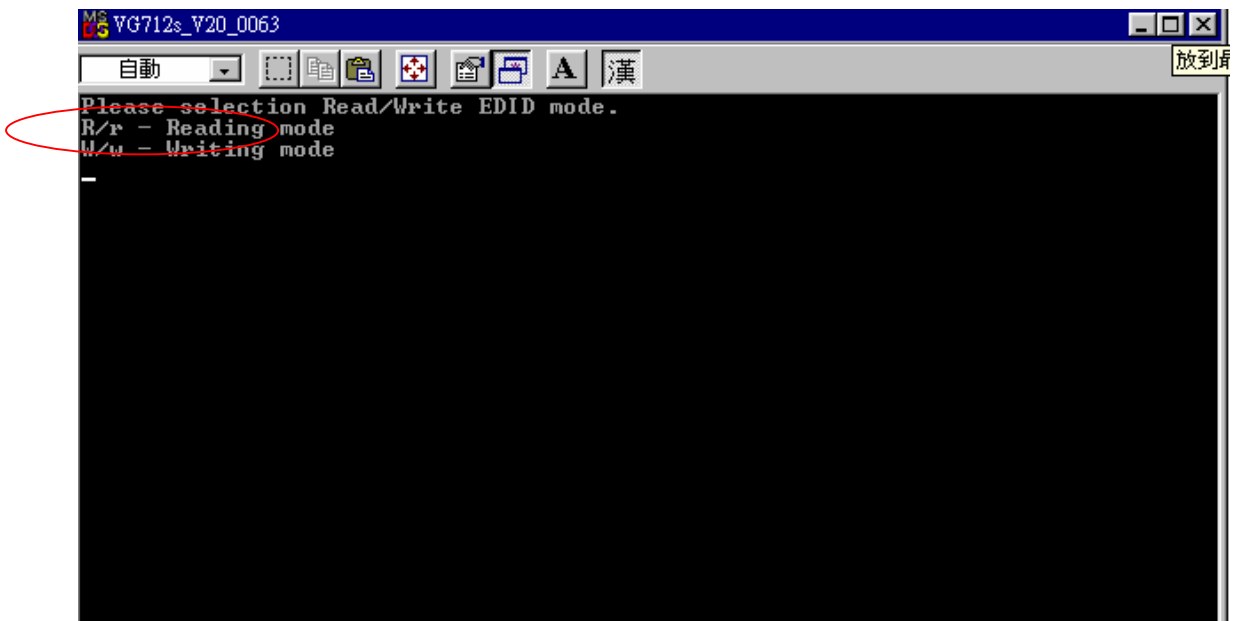

Step 3. Key in the serial number or use the barcode reader to scan the barcode of the monitor, and then press “Enter” key.

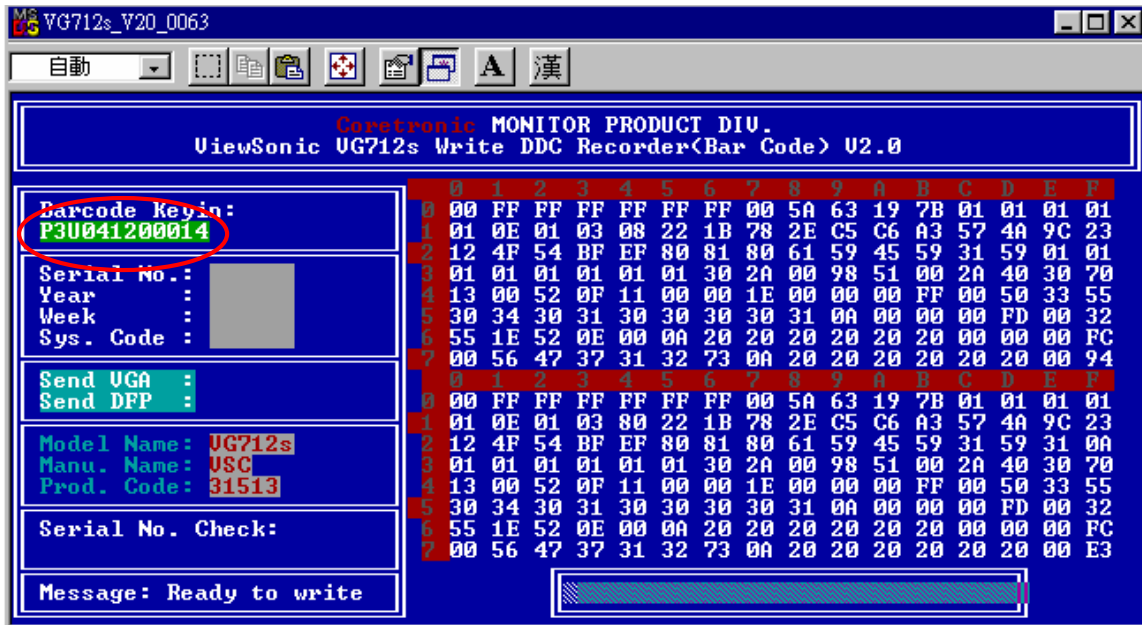

Notice: The English of the serial number should be capital letters.

Step 4. The successful picture is as follows. “The checksum values will appear after DDC is upgraded successfully in both VGA and DFP (DVI) modes.”

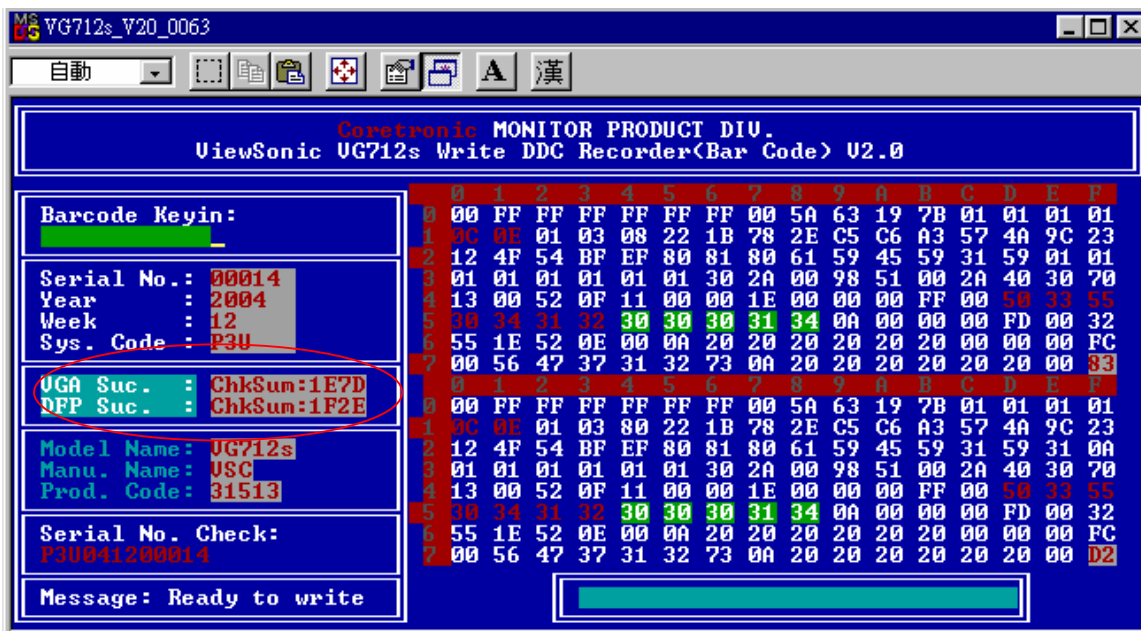

Step 5. Let VG712 enter “Burn In Mode” (Refer to Chapter III3. Hot Keys for Function Control Is). **Unplug and re-plug the power cord of the monitor.** The corrective serial number will show on the screen.

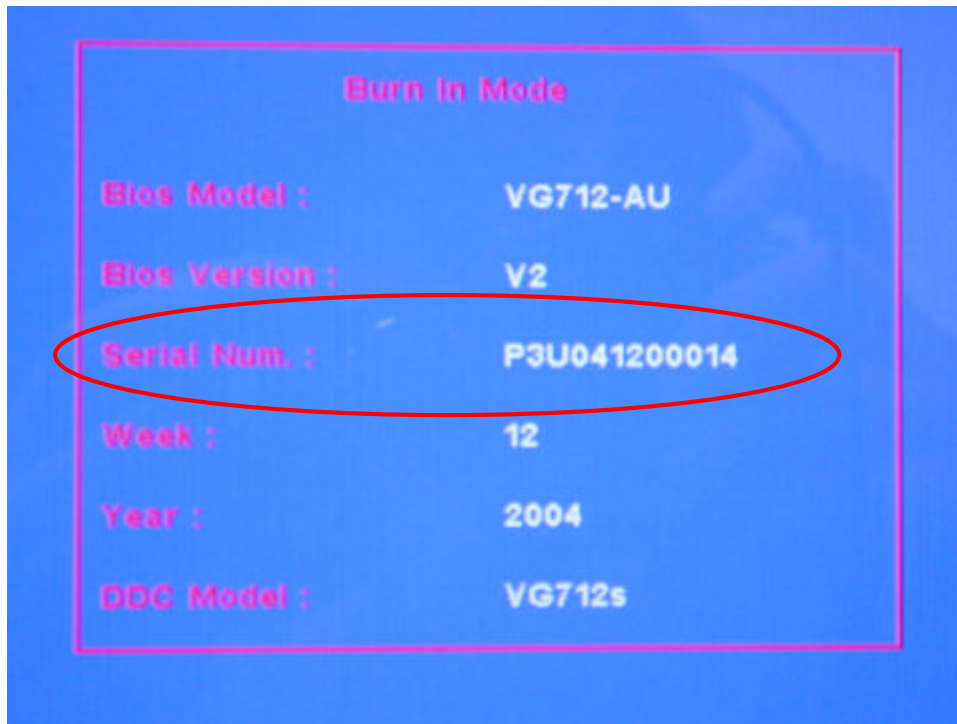

Step 6. Checking Method:

- Execute the DDC Key In program and select “R/r - Reading mode” in Step 2.
- Use the barcode reader to scan the barcode of the monitor, or manually key in the serial number. If the DDC is correct, the “Send VGA” and “Send DFP” will show “Check Pass!” message.

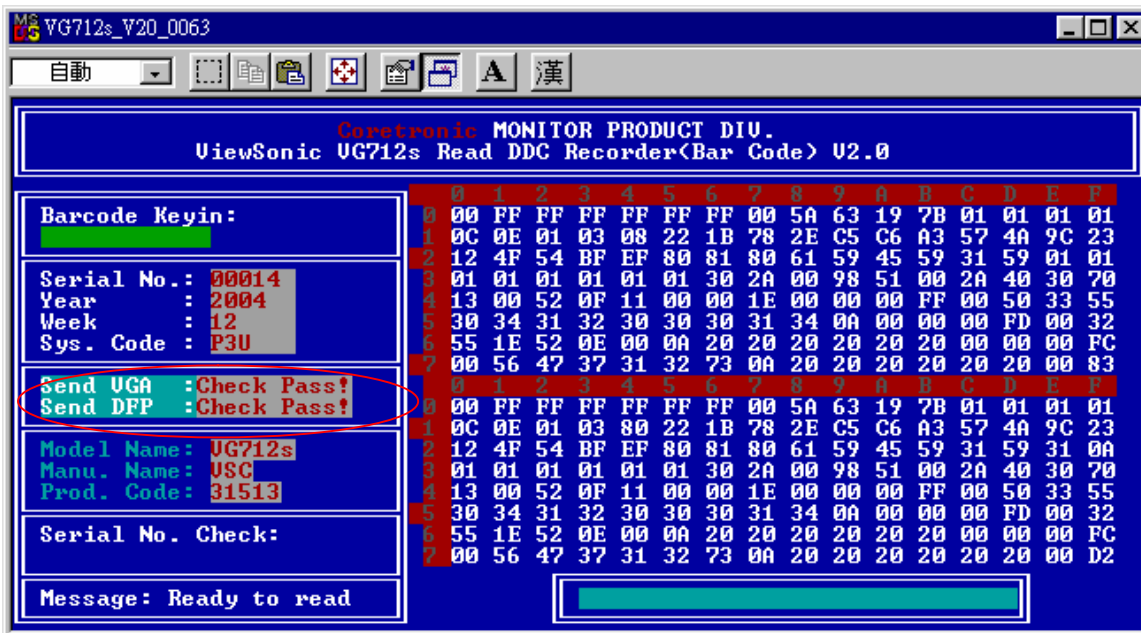

6. Trouble Shooting Flow Chart

This chapter provides technicians and people who have an electronic background a primary description about maintaining the product. Moreover, you can get the appropriate operation to solve some complicated problems of component repairing and professional problems.

1. Equipment Needed

- VG712s/b Monitor
- Philips Screw Driver #101 and #107
- Electronic Hex Nut M5 mm
- PC (Personal Computer) with SXGA resolution and sound card / Pattern Generator

2. Main Procedure

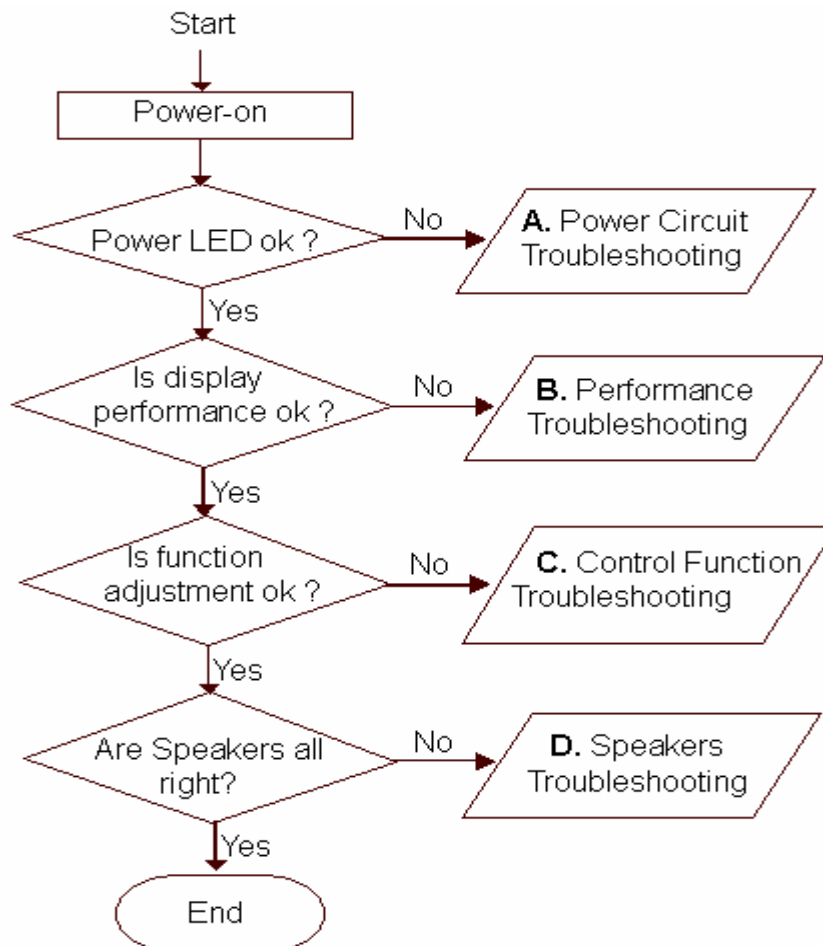

Note: Before troubleshooting, do “All Mode Reset” first to restore the monitor’s settings to the factory defaults.

2.1 A. Power Circuit Troubleshooting

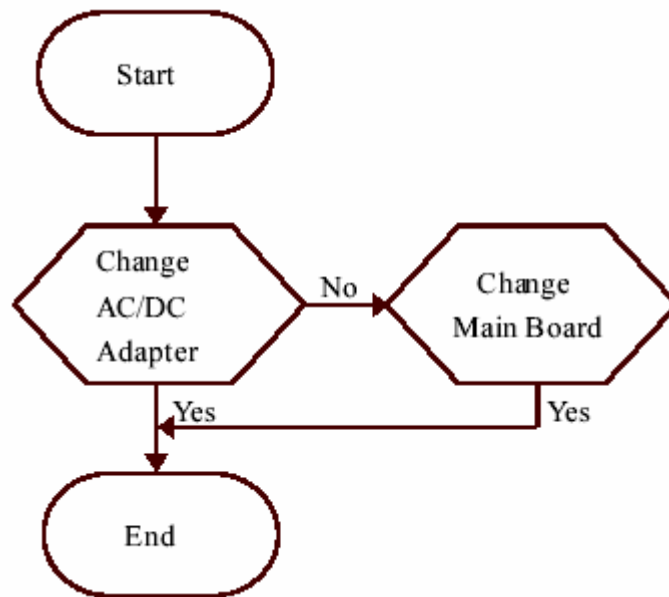

2.2 B. Performance Troubleshooting

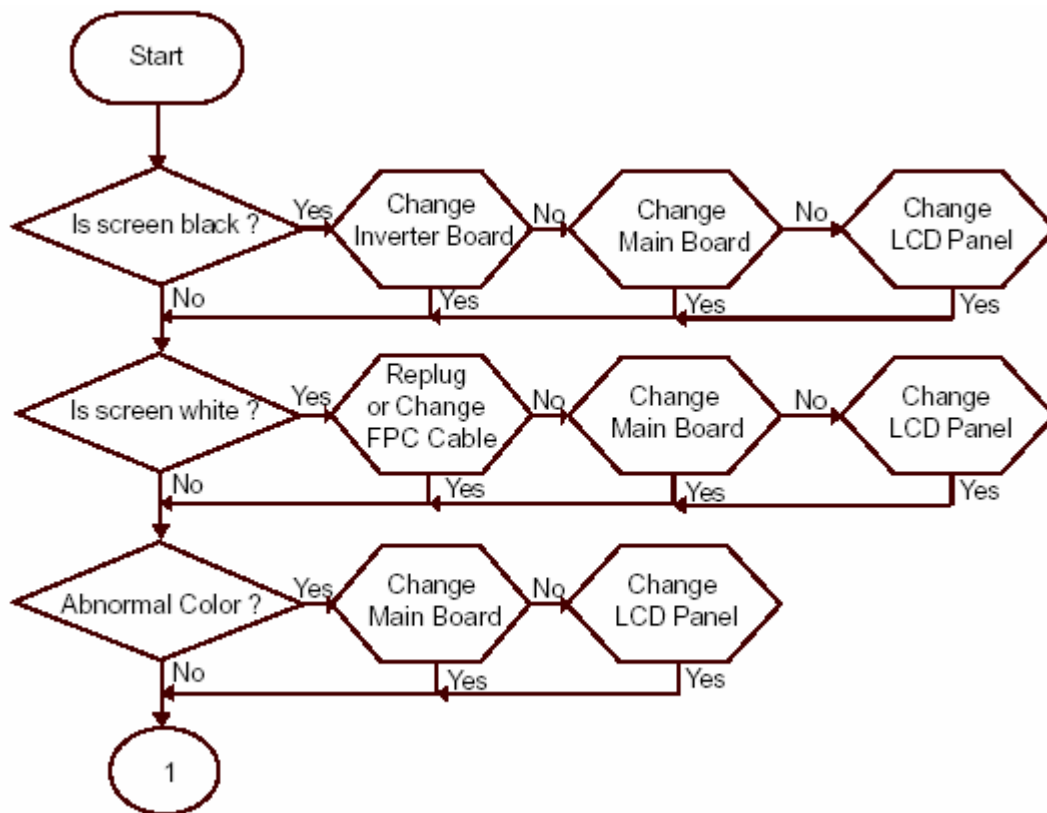

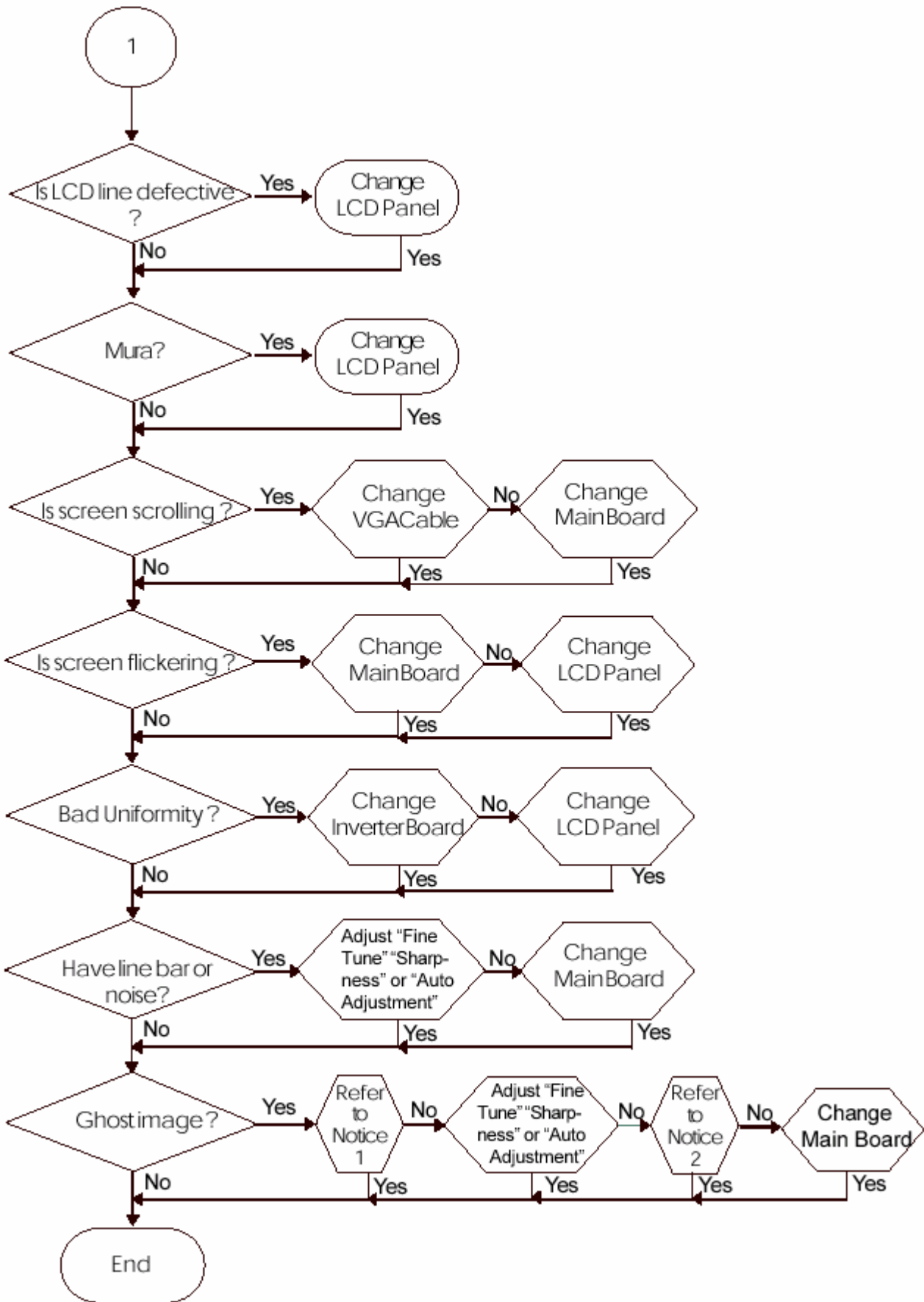

Notice:

1. Make sure VGA cable connected to PC directly, not via anything like “Data transfer” or “Distribution”After this action if Ghost image disappears, go to “Yes”; else, go to “No.”
2. Check the compatibility on the computer. If it is compatibility problem, feedback the information to ViewSonic; else, go to “No.”

2.3 C. Control Function Troubleshooting

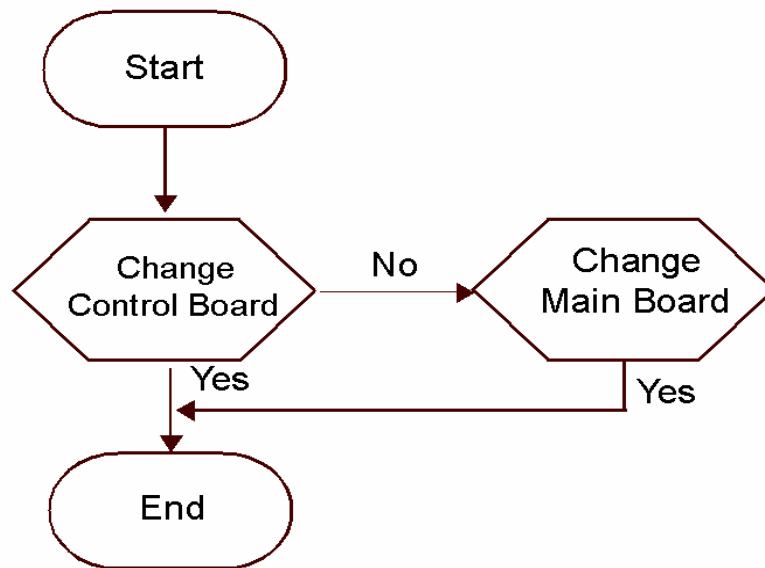

2.4 D. Speakers Troubleshooting

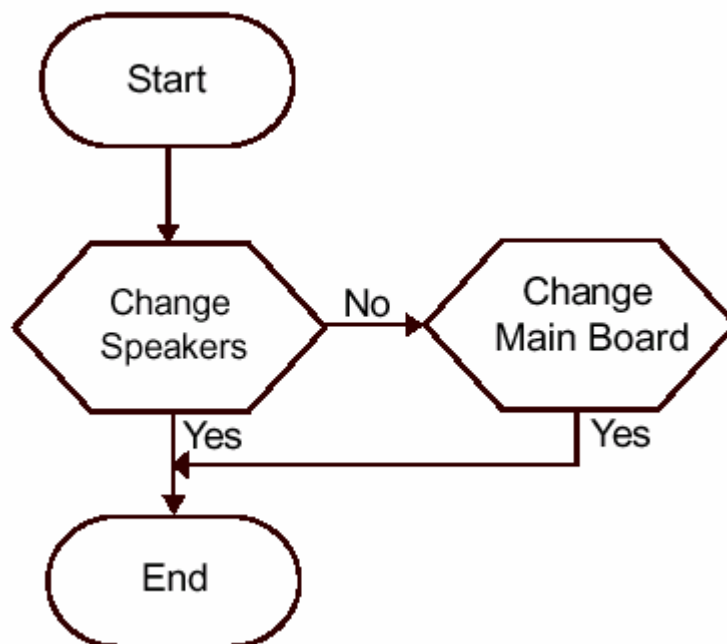

7. Recommended Spare Parts List

RECOMMENDED SPARE PARTS LIST (VG712b-1)

ViewSonic Model Number: VLCDS23719

Rev: 1a

Item	Description	ViewSonic P/N	Ref. P/N	Location	Universal number#	Q'ty
1	Accessories:	ADAPTER IN100-240V 12V/3.33A,"LSE"	A-AD-0114-0204	47.62701.001	ADAPTER	1
2	PC Board Assembly:	PCBA INVERTER:EMAX FOR 17" AUO M170EG01 V0	B-SB-0221-0700	44.58402.002	INVERTER	1
3		PCBA MAIN BD VG710 "GM5120 AU-EG01V0"	B-MB-0201-2734	80.62701.005	MAIN BOARD	GM5120
4		PCBA CTRL BD VG710	B-CB-0206-0165	80.62702.001	CONTROL BOARD	1
5	Cabinets:	ASSY STAND CS-VS08 VG710b	C-BS-0303-0571	70.62702.002	STAND	1
6		ASSY FRONT COVER CS-VS07A VG712b	C-00000212	75.62701.004	FRONT COVER	1
7		ASSY REAR COVER CS-VS08 VG710b	C-BC-0302-0539	75.62702.002	REAR COVER	1
8		BASE COVER ABS HB-VS08 VG710b	M-CV-0830-2479	51.62706.002	BASE COVER	1
9	Cables:	W.A. 10/6P ULI1007 #24 100mm VG700(INV)	M-WR-0828-0636	42.58301.001	INVERTER WIRE	1
10		W.A. 30P ULI1007 #24 225mm VG710(COST)-CMO	CB-00000213	42.62701.A01	PANEL WIRE	1
11		W.A. 12P ULI571 #28 260mm W/O CORE SHARE(MB/CTRL)	M-WR-0828-6010	42.58303.001		1
12		CABLE VGA 15P 1800mm 2*25mm CORE	A-VC-0101-0261	42.59901.003	VGA CABLE	1
13		CABLE AUDIO 1.8M LM/BK/LM VX2000	A-AU-0120-0032	42.59903.001	AUDIO CABLE	1
14	Documentation:	USER GUIDE+CD VG712b TCO99	A-CD-VG712B	36.62701.008	USER GUIDE	1
15		LABEL CAUTION HIGH VOLTAGE 25.4*19mm	M-LB-0813-1016	35.00010.002	CAUTION LABEL	1
16		LABEL CARTON 76*76mm	M-LB-0813-0706	35.58302.001	UPC LABEL	1
17		LABEL BARCODE 40*14 ViewSonic	M-LB-0813-0736	35.58304.001	BARCODE LABEL	1
18		LABEL 210*65mm BLANK FOR PALLET	M-LB-0813-1017	35.59906.001		0.0625
19		LABEL BAR CODE 50*25mm VP191	M-LB-0813-0781	35.61203.001	BARCODE LABEL	1
20		LABEL SPEC 120*50mm VG712b TCO99	M-LB-0830-0733	35.62701.005	SPEC LABEL	1
21	Electronic Components:	TFT LCD 17" AUO M170EG01 V.0	M-LCD-0826-0256	48.62701.004	PANEL	AUO M170EG01 V0
22		SPEAKER 3W FOR VG710	E-SK-0412-0080	49.62701.001	SPEAKER	1
23	Hardware:	SHIELDING BRKT-INV TINEPLATE 0.3t VG710s	M-BK-0805-0020	61.61102.002	INVERTER BRACKET	1
24		LCD BRKT SECC 1.0t VG710s	M-BK-0805-0021	61.62701.001	PANEL BRACKET	1
25		SHIELDING BRKT-MB SECC 1.0t VG710s	M-BK-0805-0022	61.62702.001	MB BRACKET	1
26		BASE PLATE SPCC-Zn 2.5t VG710s	M-MS-0808-8960	61.62703.001	BASE PLATE	1
27		HINGE SPCC-Zn 2.0t VG710s	M-MS-0808-8961	61.62704.001	HINGE	1
28	HINGE CAP ABS HB-VS08 VG710b	M-MS-0808-8954	51.62703.002	HINGE CAP	1	
29	Miscellaneous:	BIRD LOGO AL E015-006 VG710s	M-MS-0808-8946	35.62702.001	BIRD LOGO	1
30		COSMETIC STRIP ADHESIVE CS-VS06 140*21*0.3t	M-MS-0808-8947	35.62703.001	COMESTIC STRIP ADHESIVE	1
31		ViewSonic AL-LOGO E015-016-1 ViewSonic	M-MS-0808-8948	35.62704.001		1
32		EMI Tape (80773) 20*40mm	M-MS-0808-8882	41.55601.001		2
33		EMI TAPE 80773 25*75mm	M-MS-0808-8949	41.58301.001		1
34		EMI GASKET 773GT W6*H6.5*L30	M-MS-0808-8950	41.61603.001		1
35		FILAMENT TAPE 3M NO.8915 25mm*55M	M-MS-0808-8797	51.00014.002	TAPE FOR WIRE	0.0032
36		LCD PROTECT FILM 355*290*0.1t mm MYLAR VG700/VG750	M-MS-0808-8952	51.58314.001	PROTECTION FILM FOR PANEL	1
37		NAMEPLATE ELLIPSE CS-VS08 ViewSonic	M-MS-0808-8299	51.58711.002	NAMEPLATE	1
38		WIRE MOUNT MC-03A "G&A" VX930	M-MS-0808-8953	51.59907.001		5
39		MYLAR ADHESIVEt=0.3mm VP171	M-MS-0808-8750	51.61103.001	INVERTER MYLAR	1
40		PC 30*12*0.6t mm VG710	M-MS-0808-9643	51.62711.003		2
41		FRONT ARM ABS HB-VS08 VG710b	M-MS-0808-8955	51.62707.002	FRONT ARM	1
42		REAR ARM ABS HB-VS08 VG710b	M-MS-0808-8956	51.62708.002	REAR ARM	1
43	Packing Material:	CARTON AB-18 455*205*480(h) VG712b TCO99	P-BX-0601-1087	55.62701.005	CARTON	1
44		CUSHION R EPS VG710s	P-FM-0602-0818	56.62701.001	CUSHION	1
45		CUSHION L EPS VG710s	P-FM-0602-0819	56.62702.001	CUSHION	1
46		PE BAG LDPE 450*700*0.07t W/HOLE VG710	M-MS-0808-9642	51.62710.001	PE BAG	1
47	Plastics:	VESA RUBBER PAD D7.0*H4.5 VG710b	M-MS-0808-8959	52.62701.002		4
48		RUBBER SPACER 20*10*5.5mm	M-MS-0808-9644	52.62702.001		2
49		RUBBER FOOT 35*10*1.2t VG710	M-MS-0808-9645	52.62703.001	RUBBER FOOT	5
50		RUBBER 30*15*4 BLACK VG710	M-MS-0808-9646	52.62703.002		1

RECOMMENDED SPARE PARTS LIST (VG712b-M)

Item	Description	ViewSonic P/N	Ref. P/N	Location	Q'ty	
1	Accessories:	CABLE POWER CORD 1.8M±0.1M UNSHIELD (NA)	A-PC-0106-0270	42.57207.001	POWER CORD	1

RECOMMENDED SPARE PARTS LIST (VG712b-P)

Item	Description	ViewSonic P/N	Ref. P/N	Location	Q'ty	
1	Accessories:	CABLE POWER CORD 1.8M±0.1M UNSHIELD (NA)	A-PC-0106-0270	42.57207.001	POWER CORD	1

RECOMMENDED SPARE PARTS LIST (VG712b-G)

Item	Description	ViewSonic P/N	Ref. P/N	Location	Q'ty	
1	Accessories:	1.8M±0.1M COLOR CS-VS08 China	A-PC-0106-0187	42.50126.001	POWER CORD	1
1	Documentation:	WARRANTY CARD S. CHINESE SECOND VERSION VIEWSONIC	M-MS-0808-8773	36.58307.002	WARRANTY	
2		WARRANTY STICKER S. CHINESE	M-LB-0813-0737	36.58308.001	WARRANTY	
3		SHIPPING WARRANTY STICKER S. CHINESE VIEWSONIC	M-LB-0813-0739	36.58309.001	WARRANTY	
4	Packing Material:	PE BAG LDPE 750*760*0.05t VG700-1	M-MS-0808-9647	51.58317.001	PE BAG	1

RECOMMENDED SPARE PARTS LIST (VG712b-E)

Item	Description	ViewSonic P/N	Ref. P/N	Location	Q'ty	
1	Accessories:	CABLE POWER CORD 1830mm SP-023+IS14 EUR.	A-PC-0106-0271	42.50112.001	POWER CORD	1

RECOMMENDED SPARE PARTS LIST (VG712b-A)

Item	Description	ViewSonic P/N	Ref. P/N	Location	Q'ty	
1	Accessories:	CABLE POWER CORD 1830mm SP-023+IS14 EUR.	A-PC-0106-0271	42.50112.001	POWER CORD	1

RECOMMENDED SPARE PARTS LIST (VG712s-1)

ViewSonic Model Number: VLCD523719

Rev: 1b

Item	Description	ECR/ECN	ViewSonic P/N	Ref. P/N	Location	Universal number#	Q'ty
1	Accessories:						
2	PC Board Assembly:						
	ADAPTER IN100-240V 12V/3.33A;"LSE"		A-AD-0114-0204	47.62701.001	ADAPTER		1
	PCBA INVERTER:EMAX FOR 17" AUO M170EG01 V0	ECR 4990	B-SB-0221-0700	44.58402.002	INVERTER		1
3	PCBA MAIN BD VG710 "GM5120 AU-EG01V0"	ECR 4626	B-MB-0201-2734	80.62701.005	MAIN BOARD	GM5120	1
4	PCBA CTRL BD VG710		B-CB-0206-0165	80.62702.001	CONTROL BOARD		1
5	Cabinets:						
	ASSY STAND CS-VS06 VG710s		PL-PS-0715-0994	70.62702.001	STAND		1
6	ASSY FRONT COVER CS-VS07A VG712s		M-CV-0830-2564	75.62701.003	FRONT COVER		1
7	ASSY REAR COVER CS-VS06 VG710s		C-BC-0302-0540	75.62702.001	REAR COVER		1
8	BASE COVER ABS HB-VS06 VG710s		M-CV-0830-2480	51.62706.001	BASE COVER		1
9	FRONT ARM ABS HB-VS06 VG710s		M-MS-0808-8970	51.62707.001	FRONT ARM		1
10	REAR ARM ABS HB-VS06 VG710s		M-MS-0808-8971	51.62708.001	REAR ARM		1
11	Cables:						
	W.A. 10/6P UL1007 #24 100mm VG700(INV)		M-WR-0828-0636	42.58301.001	INVERTER WIRE		1
12	W.A. 30P UL1007 #24 225mm VG710(COST)-CMO	Added 10/01/04	CB-00000213	42.62701.A01	PANEL WIRE		1
13	W.A. 12P UL1571 #28 260mm W/O CORE SHARE(MB/CTRL)		M-WR-0828-6010	42.58303.001			1
14	CABLE VGA 15P 1800mm 2*25mm CORE		A-VC-0101-0261	42.59901.003	VGA CABLE		1
15	CABLE AUDIO 1.8M LM/BK/LM VX2000		A-AU-0120-0032	42.59903.001	AUDIO CABLE		1
16	Documentation:						
	USER GUIDE+CD VG712s TCO03	ECR 4626	A-CD-VG712S	36.62701.007	USER GUIDE		1
17	LABEL CAUTION HIGH VOLTAGE 25.4*19mm		M-LB-0813-1016	35.00010.002	CAUTION LABEL		1
18	LABEL CARTON 76*76mm		M-LB-0813-0706	35.58203.001	UPC LABEL		1
19	LABEL BARCODE 40*14 ViewSonic		M-LB-0813-0736	35.58304.001	BARCODE LABEL		1
20	LABEL 210*65mm BLANK FOR PALLET		M-LB-0813-1017	35.59906.001			0.0625
21	LABEL BAR CODE 50*25mm VP191		M-LB-0813-0781	35.61203.001	BARCODE LABEL		1
22	LABEL SPEC 120*50mm VG712s	Added 10/01/04	M-LB-0813-1044	35.62701.003	SPEC LABEL		1
23	TFT LCD 17" AUO M170EG01 V.0	ECR 4690	M-LCD-0826-0256	48.62701.004	PANEL	AUO M170EG01 V0	1
24	Electronic Components:						
	SPEAKER 3W FOR VG710		E-SK-0412-0080	49.62701.001	SPEAKER		1
25	Hardware:						
	SHIELDING BRKT-INV TINEPLATE 0.3t VG710s		M-BK-0805-0020	61.61102.002	INVERTER BRACKET		1
26	LCD BRKT SECC 1.0t VG710s		M-BK-0805-0021	61.62701.001	PANEL BRACKET		1
27	SHIELDING BRKT-MB SECC 1.0t VG710s		M-BK-0805-0022	61.62702.001	MB BRACKET		1
28	BASE PLATE SPCC-Zn 2.5t VG710s		M-MS-0808-8960	61.62703.001	BASE PLATE		1
29	HINGE SPCC-Zn 2.0t VG710s		M-MS-0808-8961	61.62704.001	HINGE		1
30	HINGE CAP ABS HB-VS06 VG710s		M-MS-0808-8969	51.62703.001	HINGE CAP		1
31	Miscellaneous:						
	BIRD LOGO AL E015-006 VG710s		M-MS-0808-8946	35.62702.001	BIRD LOGO		1
32	COSMETIC STRIP ADHESIVE CS-VS06 140*21*0.3t		M-MS-0808-8947	35.62703.001	COMESTIC STRIP ADHESIVE		1
33	ViewSonic AL-LOGO E015-016-1 ViewSonic		M-MS-0808-8948	35.62704.001			1
34	EMI Tape (80773) 20*40mm		M-MS-0808-8882	41.55601.001			2
35	EMI TAPE 80773 25*75mm		M-MS-0808-8949	41.58301.001			1
36	EMI GASKET 773GT W6*H6.5*L30		M-MS-0808-8950	41.61603.001			1
37	FILAMENT TAPE 3M NO.8915 25mm*55M		M-MS-0808-8797	51.00014.002	TAPE FOR WIRE		0.0032
38	LCD PROTECT FILM 355*290*0.1t mm MYLAR VG700/VG750		M-MS-0808-8952	51.58314.001	PROTECTION FILM FOR PANEL		1
39	NAMEPLATE ELLIPSE ViewSonic		M-MS-0808-8116	51.58711.001	NAMEPLATE		1
40	WIRE MOUNT MC-03A "G&A" VX930		M-MS-0808-8953	51.59907.001			5
41	MYLAR ADHESIVE=0.3mm VP171		M-MS-0808-8750	51.61103.001	INVERTER MYLAR		1
42	PC 30*12*0.6t mm VG710	Added 10/01/04	M-MS-0808-9643	51.62711.003			2
43	Packing Material:						
	CARTON AB-18 455*205*480(h) VG712s TCO99	ECR 4626	P-BX-0601-0991	55.62701.003	CARTON		1
44	CUSHION R EPS VG710s		P-FM-0602-0818	56.62701.001	CUSHION		1
45	CUSHION L EPS VG710s		P-FM-0602-0819	56.62702.001	CUSHION		1
46	PE BAG LDPE 450*700*0.07t W/HOLE VG710		M-MS-0808-9642	51.62710.001	PE BAG		1
47	Plastics:						
	RUBBER SPACER 20*10*5.5mm		M-MS-0808-9644	52.62702.001			2
48	RUBBER FOOT 35*10*1.2t VG710		M-MS-0808-9645	52.62703.001	RUBBER FOOT		5
49	RUBBER 30*15*4 BLACK VG710		M-MS-0808-9646	52.62703.002			1
50	VESA RUBBER PAD D7.0*H4.5 VG710s		M-MS-0808-8972	52.62701.001			4

RECOMMENDED SPARE PARTS LIST (VG712s-M)

Item	Description	ViewSonic P/N	Ref. P/N	Location	Q'ty
1	Accessories:				
	CABLE POWER CORD 1.8M±0.1M UNSHIELD (NA)	A-PC-0106-0270	42.57207.001	POWER CORD	1

RECOMMENDED SPARE PARTS LIST (VG712s-P)

Item	Description	ViewSonic P/N	Ref. P/N	Location	Q'ty
1	Accessories:				
	CABLE POWER CORD 1.8M±0.1M UNSHIELD (NA)	A-PC-0106-0270	42.57207.001	POWER CORD	1

RECOMMENDED SPARE PARTS LIST (VG712s-E)

Item	Description	ViewSonic P/N	Ref. P/N	Location	Q'ty
1	Accessories:				
	CABLE POWER CORD 1830mm SP-023+IS14 EUR.	A-PC-0106-0271	42.50112.001	POWER CORD	1

RECOMMENDED SPARE PARTS LIST (VG712s-G)

Item	Description	ViewSonic P/N	Ref. P/N	Location	Q'ty
1	Accessories:				
	1.8M±0.1M COLOR CS-VS08 China	A-PC-0106-0187	42.50126.001	POWER CORD	1
2	Documentation:				
	WARRANTY CARD S. CHINESE SECOND VERSION VIEWSONIC	M-MS-0808-8773	36.58307.002	WARRANTY	1
3	WARRANTY STICKER S. CHINESE	M-LB-0813-0737	36.58308.001	WARRANTY	1
4	SHIPPING WARRANTY STICKER S. CHINESE VIEWSONIC	M-LB-0813-0739	36.58309.001	WARRANTY	1
5	Packing Material:				
	PE BAG LDPE 750*760*0.05t VG700-1	M-MS-0808-9647	51.58317.001	PE BAG	1

BOM LIST (VG712b-1)

ViewSonic Model Number: VLCD523719

Rev: 1a

Item	ViewSonic P/N	Ref. P/N	Description	Location	Universal number#	Q'ty
1	M-LB-0813-1016	35.00010.002	LABEL CAUTION HIGH VOLTAGE 25.4*19mm	CAUTION LABEL		1
2	M-LB-0813-0736	35.58304.001	LABEL BARCODE 40*14 ViewSonic	BARCODE LABEL		1
3	M-LB-0813-0781	35.61203.001	LABEL BAR CODE 50*25mm VP191	BARCODE LABEL		1
4	M-LB-0830-0733	35.62701.005	LABEL SPEC 120*50mm VG712b TCO99	SPEC LABEL		1
5	M-MS-0808-8948	35.62704.001	ViewSonic AL-LOGO E015-016-1 ViewSonic			1
6	#N/A	39.62702.005	DDC RECORDER VG712b AUO EG01 V0			1
7	A-AD-0114-0204	47.62701.001	ADAPTER IN100-240V 12V/3.33A;"LSE"			1
8	M-MS-0808-8952	51.58314.001	LCD PROTECT FILM 355*290*0.1t mm MYLAR VG70	PROTECTION FILM FOR PANEL		1
9	M-MS-0808-8299	51.58711.002	NAMEPLATE ELLIPSE CS-VS08 ViewSonic	NAMEPLATE		1
10	M-MS-0808-8954	51.62703.002	HINGE CAP ABS HB-VS08 VG710b	HINGE CAP		1
11	M-MS-0808-8946	35.62702.001	BIRD LOGO AL E015-006 VG710s	BIRD LOGO		1
12	M-MS-0808-8947	35.62703.001	COSMETIC STRIP ADHESIVE CS-VS06 140*21*0.3t	COMESTIC STRIP ADHESIVE		1
13	M-MS-0808-8882	41.55601.001	EMI Tape (80773) 20*40mm			3
14	M-MS-0808-8949	41.58301.001	EMI TAPE 80773 25*75mm			1
15	M-MS-0808-8950	41.61603.001	EMI GASKET 773GT W6*H6.5*L30			1
16	M-WR-0828-0636	42.58301.001	W.A. 10/6P UL1007 #24 100mm VG700(INV)	INVERTER WIRE		1
17	CB-00000213	42.62701.A01	W.A. 30P UL1007 #24 225mm VG710(COST)-CMO	PANEL WIRE		1
18	M-WR-0828-6010	42.58303.001	W.A. 12P UL1571 #28 260mm W/O CORE SHARE(MB			1
19	B-SB-0221-0700	44.58402.002	PCBA INVERTER;EMAX FOR 17" AUO M170EG01 V0	INVERTER		1
20	M-LCD-0826-0256	48.62701.004	TFT LCD 17" AUO M170EG01 V.0	PANEL	AUO M170EG01 V0	1
21	E-SK-0412-0080	49.62701.001	SPEAKER 3W FOR VG710	SPEAKER		1
22	M-MS-0808-8797	51.00014.002	FILAMENT TAPE 3M NO.8915 25mm*55M	TAPE FOR WIRE		0.001
23	M-MS-0808-8239	51.59901.001	ACETATE TAPE W=20mm			3
24	M-MS-0808-8953	51.59907.001	WIRE MOUNT MC-03A "G&A" VX930			5
25	M-MS-0808-8750	51.61103.001	MYLAR ADHESIVE t=0.3mm VP171	INVERTER MYLAR		1
26	#N/A	51.62709.002	MYLAR ADHESIVE 150*45*0.25t VG710			1
27	M-MS-0808-9643	51.62711.003	PC 30*15*1.15tmm VG712			2
28	M-MS-0808-8959	52.62701.002	VESA RUBBER PAD D7.0*H4.5 VG710b			4
29	M-MS-0808-9644	52.62702.001	RUBBER SPACER 20*10*5.5mm			4
30	M-MS-0808-9646	52.62703.002	RUBBER 30*15*4 BLACK VG710			1
31	M-MS-0808-7882	52.62707.001	SPONGE 8.0L*6.0W*8.0H VG712s			6
32	M-BK-0805-0020	61.61102.002	SHIELDING BRKT-INV TINEPLATE 0.3t VG710s	INVERTER BRACKET		1
33	M-BK-0805-0021	61.62701.001	LCD BRKT SECC 1.0t VG710s	PANEL BRACKET		1
34	M-BK-0805-0022	61.62702.001	SHIELDING BRKT-MB SECC 1.0t VG710s	MB BRACKET		1
35	#N/A	51.62701.004	FRONT COVER ABS HB-CR VG712b			1
36	PL-BT-0706-0149	51.62704.001	SELECT BUTTON ABS HB-Cr VG710s	FRONT COVER		1
37	M-MS-0808-8973	51.62705.001	LED LENS PMMA VG710s			1
38	M-CV-0830-2630	51.62702.002	REAR COVER ABS HB-VS08 VG710b	REAR COVER		1
39	M-BK-0805-0023	61.00042.001	LOCK BRKT+CAP SECC 0.8t			1
40	B-MB-0201-2734	80.62701.005	PCBA MAIN BD VG710 "GM5120 AU-EG01V0"	MAIN BOARD		1
41	#N/A	00.58401.E01	BARE PCB L:4 MAIN BD GM5120/GM2120			1
42	#N/A	01.00034.501	RES RP 0 5% 1/4W CHIP #1206	R101		1
43	#N/A	01.00036.502	RES RP 0 5% 1/16W CHIP #0603;"TA-I TECHNOLO	C188,C30,R111,R33,R51,R54,R6,R66,R67,R68,R85,R88,R95,R98,		14
44	#N/A	01.00039.501	RES RP 0 5% 1/10W CHIP #0805	R100,R105,R116,R117		4
45	#N/A	01.10136.501	RES RP 100 5% 1/16W #0603	R110,R15,R16,R37,R38,R42		6
46	#N/A	01.10136.502	RES RP 100 5% 1/16W X4 V8V 8P SMD	RP10,RP11,RP12,RP13,RP14,RP15,RP16,RP5,RP6,RP7,RP8,RP9		12
47	#N/A	01.10216.501	RES RP 1K 1% 1/16W CHIP #0603	R55		1
48	#N/A	01.10236.501	RES RP 1K 5% 1/16W x4 V8V 8P SMD "PANAS	RP3,RP4		2
49	#N/A	01.10236.502	RES RP 1K 5% 1/16W #0603;"TA-I TECHNOLOGY"	R5,R75,R77		3
50	#N/A	01.10336.501	RES RP 10K 5% 1/16W x4 V8V 8P SMD "PANASO	RP1,RP2		2
51	#N/A	01.10336.502	RES RP 10K 5% 1/16W CHIP #0603;"TA-I TECHNO	C17,R19,R12,R121,R17,R32,R49,R50,R56,R57,R58,R59,R60,R61,R65,R69,R73		17
52	#N/A	01.10339.501	RES RP 10K 5% 1/10W CHIP #0805	R1,R2		2
53	#N/A	01.10436.501	RES RP 100K 5% 1/16W CHIP #0603	R10,R9		2
54	#N/A	01.20116.501	RES RP 200 1% 1/16W CHIP #0603	R7		1
55	#N/A	01.22036.501	RES RP 22 5% 1/16W CHIP #0603	R18,R20,R22		3
56	#N/A	01.22236.501	RES RP 2.2K 5% 1/16W CHIP #0603	R34,R35,R43,R44,R47,R81,R82		7
57	#N/A	01.33036.501	RES RP 33 5% 1/16W x4 V8V 8P SMD "PANASON	RP17		1
58	#N/A	01.33036.502	RES RP 33 5% 1/16W CHIP #0603;"TA-I TECHNOL	R124,R125,R126,R40,R41,R52,R53		7

Item	ViewSonic P/N	Ref. P/N	Description	Location	Universal number#	Q'ty
59	#N/A	01.33116.501	RES RP 330 1% 1/16W CHIP #0603	R28,R29,R3,R4,R8		5
60	#N/A	01.33336.501	RES RP 33K 5% 1/16W CHIP #0603	R80		1
61	#N/A	01.47236.501	RES RP 4.7K 5% 1/16W CHIP #0603	R13,R14		2
62	#N/A	01.56236.501	RES RP 5.6K 5% 1/16W CHIP #0603	R72		1
63	#N/A	01.68036.501	RES RP 68 5% 1/16W CHIP #0603	R45		1
64	#N/A	01.68336.501	RES RP 68K 5% 1/16W CHIP 0603	R76		1
65	#N/A	01.75016.501	RES RP 75 1% 1/16W CHIP #0603;"TA-I TECHNOL	R24,R25,R26		3
66	#N/A	01.75116.501	RES RP 750 1% 1/16W CHIP #0603	R11		1
67	#N/A	01.78216.501	RES RP 7.87K 1% 1/16W CHIP #0603	R78,R79		2
68	#N/A	02.10075.402	CAP CE 10u 25V 20% 5*11mm 105 DEGREE C (PZ)	C114,C121,C124		3
69	#N/A	02.10174.404	CAP CE 100u 20% 16V 6.3*11 RADIAL 105 degre	C100,C118,C12,C14,C174,C19,C22,C25,C29,C32,C62,C77,C9,C90		14
70	#N/A	02.10273.404	CAP CE 1000u 10V 20% 10*16mm 105 (HF) LOW	C27		1
71	#N/A	02.10274.403	CAP CE 1000u 16V 20% 10*20mm 105 (HD) LOW	C123,C5		2
72	#N/A	02.10547.102	CAP CC 100pF 5% 50V NPO #0603	C102,C165,C166,C167,C168,C186,C187,C89		8
73	#N/A	02.10747.101	CAP CC 0.01uF 10% 50V X7R #0603;"YCTC""TEAM	C122,C163,C164,C41,C42,C43,C44,C45,C46		9
74	#N/A	02.10887.101	CAP CC 0.1uF +80%-20% 50V Y5V #0603; "YCTC"	C10,C101,C105,C108,C109,C11,C110,C111,C125,C126,C127,C128,C129,C130,C131,C132,C133,C134,C136,C137,C138,C139,C140,C141,C143,C144,C145,C146,C147,C148,C149,C150,C151,C152,C153,C154,C155,C156,C157,C158,C159,C16,C161,C162,C169,C171,C172,C175,C176,C18,C180,C181,C182,C183,C184,C2,C202,C203,C21,C23,C24,C26,C28,C3,C33,C35,C37,C39,C40,C48,C49,C57,C63,C64,C65,C66,C67,C68,C69,C7,C70,C71,C72,C73,C74,C78,C79,C8,C80,C81,C82,C83,C84,C85,C86,C87,C88,C91,C92,C93,C94,C95,C96,C97,C98,C99		106
75	#N/A	02.10987.101	CAP CC 1uF +80%-20% 16V Y5V #0603	C115,C116,C117		3
76	#N/A	02.12174.401	CAP CE 120uF 20% 16V LOW-ESR TYPE RC=405mA	C1,C20		2
77	#N/A	02.22447.101	CAP CC 22pF 5% 50V NPO #0603; "YCTC","TEAM	C192,C59,C60,C61,C75,C76		6
78	#N/A	02.33575.101	CAP CC 330pF 8P4C 20% 25V #1206 "INPAQ"	CP13,CP14		2
79	#N/A	02.50347.101	CAP CC 5pF 5% 50V NPO X7R #0603	C103,C104		2
80	#N/A	03.00052.401	INDCTOR BEAD MLB-160808-0600A-N1 SMD ; "MAG	L20,L21		2
81	#N/A	03.00072.401	EMI Bead MLB-201209-0300A-N1	L15,L17,L18,L19,L3		5
82	#N/A	03.00127.401	INDCTR BEAD #0805 100MHz 30R MLB201209-0030	R127,R128,R129		3
83	#N/A	03.15100.301	INDCTR CHOKE 150uH 20% 3A DIP A0060D1 "ARON	L4		1
84	#N/A	03.22040.301	INDCTR CHOKE COIL 22u 10% 3A DIP A0060C2 "	L1,L16,L5,L9		4
85	#N/A	07.14318.001	XTAL 14.318MHz HC-49S HALF SIZE "鸿星"	X1		1
86	#N/A	08.2N390.402	TRNSTR NPN GENERAL MMBT3904LT1 SOT-23 "MO	Q2,Q3		2
87	#N/A	08.2N390.603	TRANSTR PNP GENERAL PURPOSE 2N3906 SST3 "RO	Q4		1
88	#N/A	09.1N414.802	DIODE RLS4148 / PMLL4148L SMD "PHILIPS"	D13		1
89	#N/A	09.1N582.201	DIODE IN5822 SCHOTTKY RECTIFIER DO201AD	D1		1
90	#N/A	09.DAN20.2K1	DIODE ARRAY DAN202K SMD; "ROHM"	D2,D3		2
91	#N/A	11.035F1.301	CNNT F3P PWR JACK 2.54mm DIP 2DC-S005D100	JP2		1
92	#N/A	11.042M2.306	CNNT M 4P 2mm RT/LEAD TU2001WNR-04 "TYU"	JP10		1
93	#N/A	11.059F2.014	CNNT PHONE JACK 5P ST/LEAD A71-5AYLT1 LIM	JP9		1
94	#N/A	11.102M2.303	CNNT 10P 2.0mm TU2001WNR-10 RT/DIP;"TYU"	JP3		1
95	#N/A	11.122M2.303	CNNT 12P 2.0mm TU2001WNR-12 RT/DIP;"TYU"	JP7		1
96	#N/A	11.155F2.203	CNNT D-SUB 15P RT/LEAD BLUE PC99 VGA	JP6		1
97	M-MS-0808-9904	11.299F2.211	CNNT DVI-I F 29P 1.91mm RT/LEAD HELM QH11121-CPQ "HELM"	JP5		1
98	#N/A	11.302M2.301	CNNT M 30P 2mm RT/LEAD P220-2*15-R ;"LCU"	JP11		1
99	E-IC-0401-2771	20.24LC2.1A1	IC CMOS 24LC21A EEPROM 128*8 BIT 8SOIC	U7,U8		2
100	#N/A	20.74LVC.141	IC CMOS 74LVC14 INNERT SCHMITT-TR 14SOIC ;	U6		1
101	#N/A	20.AIC10.842	IC AIC1084;(TO252) 5A ADJUSTABLE REGULATOR	U1,U3		2
102	#N/A	20.AN752.201	IC AUDIO AN7522 DUAL 3-W AMPLIFIER	U12		1
103	#N/A	20.AP150.101	IC AP1501 5V SWITCHING REGULATOR SMD 150KHz	U4		1
104	#N/A	20.GM512.001	IC GM5120 Dual-Interface SXGA 208P PQFP "GE	U9	GM5120	1

Item	ViewSonic P/N	Ref. P/N	Description	Location	Universal number#	Q'ty
105	#N/A	20.SI230.4D1	IC NMOS SI2304DS VISHAY SOT-23	Q1		1
106	#N/A	20.THC63.LV1	IC THC63LVDM83A 85MHZ LVDS TSSOP	U13,U14		2
107	#N/A	21.24LC1.601	IC EEPROM 24LC16B/SN M 2K*8 BIT IIC BUS 8SO	U10		1
108	#N/A	22.62701.005	PROGRAMMED IC VG710 "GM5120 AU-EG01V0"			1
109	#N/A	21.Pm39L.V01	IC Pm39LV010 CMOS Flash memory 1Megabit(128			1
110	#N/A	39.62701.005	FW BIOS SOURCE CODE "GM5120 AU-EG01V0"			1
111	#N/A	35.00017.001	LABEL BIOS 13*11mm BLANK			1
112	#N/A	35.00018.001	LABEL BARCODE 13*26.5mm BLANK			2
113	#N/A	35.59907.001	LABEL SPEC ASIC 13*11mm BLANK For VIEWSONIC			1
114	#N/A	61.00039.001	EYELET BR f 3*4.0			2
115	#N/A	61.59901.001	SHIELDING PLATE DVI T-PLATE 0.3t			1
116	B-CB-0206-0165	80.62702.001	PCBA CTRL BD VG710	CONTROL BOARD		1
117	#N/A	00.62701.A01	BARE PCB L:2 CTRL BD VG710			1
118	#N/A	09.LTL1B.ED1	DIODE LED 3mm Yellow/Green LTL-1BEDJ			1
119	#N/A	11.122M2.302	CNNT M 12P 2mm RT/LEAD P-220-2*6-R			1
120	#N/A	35.00016.001	LABEL BARCODE 6*38mm BLANK			1
121	#N/A	43.52102.002	SWITCH PUSH PT-002-B2 DC12V 50mA	SW1,SW2,SW3,SW4,SW5,SW5,SW7,SW8		8
122	M-MS-0808-6287	85.005AG.075	SCREW HEX I/O #4-40*H5*L7.5 Ni NYLOK			4
123	M-SCW-0824-0651	85.1F123.060	SCREW PAN MECH W/SF M3*6 Ni			19
124	M-SCW-0824-6753	85.4A323.040	SCREW FLATE MECH M3*4 BLACK			2
125	M-SCW-0824-6756	85.TA123.080	SCREW CAP TAP M3*8 Ni			4
126	M-SCW-0824-6755	85.UA123.080	DOUBLE THREADS SCREW PAN TAP M3*8 Ni			3
127	M-CV-0830-2479	51.62706.002	BASE COVER ABS HB-VS08 VG710b	BASE COVER		1
128	M-MS-0808-8955	51.62707.002	FRONT ARM ABS HB-VS08 VG710b	FRONT ARM		1
129	M-MS-0808-8956	51.62708.002	REAR ARM ABS HB-VS08 VG710b	REAR ARM		1
130	M-MS-0808-9645	52.62703.001	RUBBER FOOT 35*10*1.2t VG710	RUBBER FOOT		5
131	M-MS-0808-8960	61.62703.001	BASE PLATE SPCC-Zn 2.5t VG710s	BASE PLATE		1
132	M-MS-0808-8961	61.62704.001	HINGE SPCC-Zn 2.0t VG710s	HINGE		1
133	M-SCW-0824-6757	85.1F124.120	SCREW PAN MECH W/SF M4*12 Ni			4
134	M-SCW-0824-6754	85.4A524.080	SCREW FLAT MECH W/O M4*8 NYLOK			4
135	M-SCW-0824-6755	85.UA123.080	DOUBLE THREADS SCREW PAN TAP M3*8 Ni			1
136	M-SCW-0824-6872	85.YA123.070	SCREW FLAT TAP M3*7 Ni			4
137	M-LB-0813-1017	35.59906.001	LABEL 210*65mm BLANK FOR PALLET			0.063
138	#N/A	51.00069.001	PACKING STRAP 12MM*2000M*0.6MM			0.023
139	#N/A	51.00070.001	PE STRETCH FILM 500MM*1500M*0.02MM			3E-04
140	#N/A	51.00080.001	3 INCH TRANSPARENT ADHESIVE TAPE (600M)			0.002
141	#N/A	55.55103.001	CORNER BOARD 40*40*5*1050mm			0.063
142	#N/A	55.57202.001	CORNER BOARD 40*40*5*960mm			0.063
143	#N/A	55.58303.002	CORNER BOARD 40*40*5*2120mm VG700-1			0.125
144	#N/A	55.62702.001	COVER PALLET AB FLUTE 112.5*95*0.7cm FOR VG			0.031
145	#N/A	58.62701.001	WOOD PALLET 1125*950*130 VG710s			0.031
146	M-LB-0813-0706	35.58203.001	LABEL CARTON 76*76mm			1
147	A-CD-VG712B	36.62701.008	USER GUIDE+CD VG712b TCO'99	USER GUIDE		1
148	A-VC-0101-0261	42.59901.003	CABLE VGA 15P 1800mm 2*25mm CORE	VGA CABLE		1
149	A-AU-0120-0032	42.59903.001	CABLE AUDIO 1.8M LM/BK/LM VX2000	AUDIO CABLE		1
150	M-MS-0808-9642	51.62710.001	PE BAG LDPE 450*700*0.07t W/HOLE VG710	PE BAG		1
151	P-BX-0601-1087	55.62701.005	CARTON AB-18 455*205*480(h) VG712b TCO'99	CARTON		1
152	P-FM-0602-0818	56.62701.001	CUSHION R EPS VG710s	CUSHION		1
153	P-FM-0602-0819	56.62702.001	CUSHION L EPS VG710s	CUSHION		1

BOM LIST (VG712s-1)

ViewSonic Model Number: VLCD523719
Rev: 1b

Item	ViewSonic P/N	Ref. P/N	Description	Location	Universal number#	Q'ty
1	M-LB-0813-1016	35.00010.002	LABEL CAUTION HIGH VOLTAGE 25.4*19mm	CAUTION LABEL		1
2	M-LB-0813-0736	35.58304.001	LABEL BARCODE 40*14 ViewSonic	BARCODE LABEL		1
3	M-LB-0813-0781	35.61203.001	LABEL BAR CODE 50*25mm VP191	BARCODE LABEL		1
4	M-LB-0813-1044	35.62701.003	LABEL SPEC 120*50mm VG712s	SPEC LABEL		1
5	M-MS-0808-8948	35.62704.001	ViewSonic AL-LOGO E015-016-1 ViewSonic			1
6	#N/A	39.62702.005	DDC RECORDER VG712b AUO EG01 V0			1
7	A-AD-0114-0204	47.62701.001	ADAPTER IN100-240V 12V/3.33A;"LSE"			1
8	M-MS-0808-8952	51.58314.001	LCD PROTECT FILM 355*290*0.1t mm MYLAR VG70	PROTECTION FILM FOR PANEL		1
9	M-MS-0808-8116	51.58711.001	NAMEPLATE ELLIPSE ViewSonic	NAMEPLATE		1
10	M-MS-0808-8969	51.62703.001	HINGE CAP ABS HB-VS06 VG710s	HINGE CAP		1
11	M-MS-0808-8946	35.62702.001	BIRD LOGO AL E015-006 VG710s	BIRD LOGO		1
12	M-MS-0808-8947	35.62703.001	COSMETIC STRIP ADHESIVE CS-VS06 140*21*0.3t	COMESTIC STRIP ADHESIVE		1
13	M-MS-0808-8882	41.55601.001	EMI Tape (80773) 20*40mm			3
14	M-MS-0808-8949	41.58301.001	EMI TAPE 80773 25*75mm			1
15	M-MS-0808-8950	41.61603.001	EMI GASKET 773GT W6*H6.5*L30			1
16	M-WR-0828-0636	42.58301.001	W.A. 10/6P UL1007 #24 100mm VG700(INV)	INVERTER WIRE		1
17	CB-00000213	42.62701.A01	W.A. 30P UL1007 #24 225mm VG710(COST)-CMO	PANEL WIRE		1
18	M-WR-0828-6010	42.58303.001	W.A. 12P UL1571 #28 260mm W/O CORE SHARE(MB)			1
19	B-SB-0221-0700	44.58402.002	PCBA INVERTER:EMAX FOR 17" AUO M170EG01 V0	INVERTER		1
20	M-LCD-0826-0256	48.62701.004	TFT LCD 17" AUO M170EG01 V.0	PANEL	AUO M17EG01 V0	1
21	E-SK-0412-0080	49.62701.001	SPEAKER 3W FOR VG710	SPEAKER		1
22	M-MS-0808-8797	51.00014.002	FILAMENT TAPE 3M NO.8915 25mm*55M	TAPE FOR WIRE		0.001
23	M-MS-0808-8239	51.59901.001	ACETATE TAPE W=20mm			3
24	M-MS-0808-8953	51.59907.001	WIRE MOUNT MC-03A "G&A" VX930			5
25	M-MS-0808-8750	51.61103.001	MYLAR ADHESIVEt=0.3mm VP171	INVERTER MYLAR		1
26	#N/A	51.62709.002	MYLAR ADHESIVE 150*45*0.25t VG710			1
27	M-MS-0808-9643	51.62711.003	PC 30*15*1.15tmm VG712			2
28	M-MS-0808-8972	52.62701.001	VESA RUBBER PAD D7.0*H4.5 VG710s			4
29	M-MS-0808-9644	52.62702.001	RUBBER SPACER 20*10*5.5mm			4
30	M-MS-0808-9646	52.62703.002	RUBBER 30*15*4 BLACK VG710			1
31	M-MS-0808-7882	52.62707.001	SPONGE 8.0L*6.0W*8.0H VG712s			6
32	M-BK-0805-0020	61.61102.002	SHIELDING BRKT-INV TINEPLATE 0.3t VG710s	INVERTER BRACKET		1
33	M-BK-0805-0021	61.62701.001	LCD BRKT SECC 1.0t VG710s	PANEL BRACKET		1
34	M-BK-0805-0022	61.62702.001	SHIELDING BRKT-MB SECC 1.0t VG710s	MB BRACKET		1
35	C-FP-0301-1037	51.62701.003	FRONT COVER ABS HB-CR VG712s			1
36	PL-BT-0706-0149	51.62704.001	SELECT BUTTON ABS HB-Cr VG710s	FRONT COVER		1
37	M-MS-0808-8973	51.62705.001	LED LENS PMMA VG710s			1
38	C-BC-0302-0541	51.62702.001	REAR COVER ABS HB-VS06 VG710s	REAR COVER		1
39	M-BK-0805-0023	61.00042.001	LOCK BRKT+CAP SECC 0.8t			1
40	B-MB-0201-2734	80.62701.005	PCBA MAIN BD VG710 "GM5120 AU-EG01V0"	MAIN BOARD		1
41	#N/A	00.58401.E01	BARE PCB L:4 MAIN BD GM5120/GM2120			1
42	#N/A	01.00034.501	RES RP 0.5% 1/4W CHIP #1206	R101		1
43	#N/A	01.00036.502	RES RP 0.5% 1/16W CHIP #0603;"TA-1 TECHNOLO	C188,C30,R111,R33,R51,R54,R6,R66,R67,R68,R85,R88,R95,R98,		14
44	#N/A	01.00039.501	RES RP 0.5% 1/10W CHIP #0805	R100,R105,R116,R117		4
45	#N/A	01.10136.501	RES RP 100 5% 1/16W #0603	R110,R15,R16,R37,R38,R42		6
46	#N/A	01.10136.502	RES RP 100 5% 1/16W X4 V8V 8P SMD	RP10,RP11,RP12,RP13,RP14,RP15,RP16,RP5,RP6,RP7,RP8,RP9		12
47	#N/A	01.10216.501	RES RP 1K 1% 1/16W CHIP #0603	R55		1
48	#N/A	01.10236.501	RES RP 1K 5% 1/16W x4 V8V 8P SMD "PANAS	RP3,RP4		2
49	#N/A	01.10236.502	RES RP 1K 5% 1/16W #0603;"TA-I TECHNOLOGY"	R5,R75,R77		3
50	#N/A	01.10336.501	RES RP 10K 5% 1/16W x4 V8V 8P SMD "PANASO	RP1,RP2		2
51	#N/A	01.10336.502	RES RP 10K 5% 1/16W CHIP #0603;"TA-I TECHNO	C17,R119,R12,R121,R17,R32,R49,R50,R56,R57,R58,R59,R60,R61,R65,R69,R73		17
52	#N/A	01.10339.501	RES RP 10K 5% 1/10W CHIP #0805	R1,R2		2
53	#N/A	01.10436.501	RES RP 100K 5% 1/16W CHIP #0603	R10,R9		2
54	#N/A	01.20116.501	RES RP 200 1% 1/16W CHIP #0603	R7		1
55	#N/A	01.22036.501	RES RP 22 5% 1/16W CHIP #0603	R18,R20,R22		3
56	#N/A	01.22236.501	RES RP 2.2K 5% 1/16W CHIP #0603	R34,R35,R43,R44,R47,R81,R82		7
57	#N/A	01.33036.501	RES RP 33 5% 1/16W x4 V8V 8P SMD "PANASON	RP17		1

Item	ViewSonic P/N	Ref. P/N	Description	Location	Universal number#	Q'ty
58	#N/A	01.33036.502	RES RP 33 5% 1/16W CHIP #0603;"TA-I TECHNOL	R124,R125,R126,R40,R41,R52,R53		7
59	#N/A	01.33116.501	RES RP 330 1% 1/16W CHIP #0603	R28,R29,R3,R4,R8		5
60	#N/A	01.33336.501	RES RP 33K 5% 1/16W CHIP #0603	R80		1
61	#N/A	01.47236.501	RES RP 4.7K 5% 1/16W CHIP #0603	R13,R14		2
62	#N/A	01.56236.501	RES RP 5.6K 5% 1/16W CHIP #0603	R72		1
63	#N/A	01.68036.501	RES RP 68 5% 1/16W CHIP #0603	R45		1
64	#N/A	01.68336.501	RES RP 68K 5% 1/16W CHIP 0603	R76		1
65	#N/A	01.75016.501	RES RP 75 1% 1/16W CHIP #0603;"TA-I TECHNOL	R24,R25,R26		3
66	#N/A	01.75116.501	RES RP 750 1% 1/16W CHIP #0603	R11		1
67	#N/A	01.78216.501	RES RP 7.87K 1% 1/16W CHIP #0603	R78,R79		2
68	#N/A	02.10075.402	CAP CE 10u 25V 20% 5*11mm 105 DEGREE C (PZ)	C114,C121,C124		3
69	#N/A	02.10174.404	CAP CE 100u 20% 16V 6.3*11 RADIAL 105 degre	C100,C118,C12,C14,C174,C19,C22,C25,C29,C32,C62,C77,C9,C90		14
70	#N/A	02.10273.404	CAP CE 1000u 10V 20% 10*16mm 105 (HF) LOW	C27		1
71	#N/A	02.10274.403	CAP CE 1000u 16V 20% 10*20mm 105 (HD) LOW	C123,C5		2
72	#N/A	02.10547.102	CAP CC 100pF 5% 50V NPO #0603	C102,C165,C166,C167,C168,C186,C187,C89		8
73	#N/A	02.10747.101	CAP CC 0.01uF 10% 50V X7R #0603;"YCTC""TEAM	C122,C163,C164,C41,C42,C43,C44,C45,C46		9
74	#N/A	02.10887.101	CAP CC 0.1uF +80%-20% 50V Y5V #0603; "YCTC"	C10,C101,C105,C108,C109,C11,C110,C111,C125,C126,C127,C128,C129,C130,C131,C132,C133,C134,C136,C137,C138,C139,C140,C141,C143,C144,C145,C146,C147,C148,C149,C150,C151,C152,C153,C154,C155,C156,C157,C158,C159,C16,C161,C162,C169,C171,C172,C175,C176,C18,C180,C181,C182,C183,C184,C2,C202,C203,C21,C23,C24,C26,C28,C3,C33,C35,C37,C39,C40,C48,C49,C57,C63,C64,C65,C66,C67,C68,C69,C7,C70,C71,C72,C73,C74,C78,C79,C8,C80,C81,C82,C83,C84,C85,C86,C87,C88,C91,C92,C93,C94,C95,C96,C97,C98,C99		106
75	#N/A	02.10987.101	CAP CC 1uF +80%-20% 16V Y5V #0603	C115,C116,C117		3
76	#N/A	02.12174.401	CAP CE 120uF 20% 16V LOW-ESR TYPE RC=405mA	C1,C20		2
77	#N/A	02.22447.101	CAP CC 22pF 5% 50V NPO #0603; "YCTC","TEAM	C192,C59,C60,C61,C75,C76		6
78	#N/A	02.33575.101	CAP CC 330pF 8P4C 20% 25V #1206 "INPAQ"	CP13,CP14		2
79	#N/A	02.50347.101	CAP CC 5pF 5% 50V NPO X7R #0603	C103,C104		2
80	#N/A	03.00052.401	INDCTOR BEAD MLB-160808-0600A-N1 SMD ; "MAG	L20,L21		2
81	#N/A	03.00072.401	EMI Bead MLB-201209-0300A-N1	L15,L17,L18,L19,L3		5
82	#N/A	03.00127.401	INDCTR BEAD #0805 100MHz 30R MLB201209-0030	R127,R128,R129		3
83	#N/A	03.15100.301	INDCTR CHOKE 150uH 20% 3A DIP A0060D1 "ARON	L4		1
84	#N/A	03.22040.301	INDCTR CHOKE COIL 22u 10% 3A DIP A00601C2 "	L1,L16,L5,L9		4
85	#N/A	07.14318.001	XTAL 14.318MHz HC-49S HALF SIZE "鸿星"	X1		1
86	#N/A	08.2N390.402	TRNSTR NPN GENERAL MMBT3904LT1 SOT-23 "MO	Q2,Q3		2
87	#N/A	08.2N390.603	TRANSTR PNP GENERAL PURPOSE 2N3906 SST3 "RO	Q4		1
88	#N/A	09.1N414.802	DIODE RLS4148 / PMLL4148L SMD "PHILIPS"	D13		1
89	#N/A	09.1N582.201	DIODE IN5822 SCHOTTKY RECTIFIER DO201AD	D1		1
90	#N/A	09.DAN20.2K1	DIODE ARRAY DAN202K SMD; "ROHM"	D2,D3		2
91	#N/A	11.035F1.301	CNNT F3P PWR JACK 2.54mm DIP 2DC-S005D100	JP2		1
92	#N/A	11.042M2.306	CNNT M 4P 2mm RT/LEAD TU2001WNR-04 "TYU"	JP10		1
93	#N/A	11.059F2.014	CNNT PHONE JACK 5P ST/LEAD A71-5AYLT1 LIME(JP9		1

Item	ViewSonic P/N	Ref. P/N	Description	Location	Universal number#	Q'ty
94	#N/A	11.102M2.303	CNNT 10P 2.0mm TU2001WNR-10 RT/DIP;"TYU"	JP3		1
95	#N/A	11.122M2.303	CNNT 12P 2.0mm TU2001WNR-12 RT/DIP;"TYU"	JP7		1
96	#N/A	11.155F2.203	CNNT D-SUB 15P RT/LEAD BLUE PC99 VGA	JP6		1
97	M-MS-0808-9904	11.299F2.211	CNNT DVI-I F 29P 1.91mm RT/LEAD HELM QH11121-CPQ "HELM"	JP5		1
98	#N/A	11.302M2.301	CNNT M 30P 2mm RT/LEAD P220-2*15-R ;"LCU"	JP11		1
99	E-IC-0401-2771	20.24LC2.1A1	IC CMOS 24LC21A EEPROM 128*8 BIT 8SOIC	U7,U8		2
100	#N/A	20.74LVC.141	IC CMOS 74LVC14 INNERT SCHMITT-TR 14SOIC ;	U6		1
101	#N/A	20.AIC10.842	IC AIC1084:(TO252) 5A ADJUSTABLE REGULATOR	U1,U3		2
102	#N/A	20.AN752.201	IC AUDIO AN7522 DUAL 3-W AMPLIFIER	U12		1
103	#N/A	20.AP150.101	IC AP1501 5V SWITCHING REGULATOR SMD 150KHz	U4		1
104	#N/A	20.GM512.001	IC GM5120 Dual-Interface SXGA 208P PQFP "GE	U9	GM5120	1
105	#N/A	20.SI230.4D1	IC NMOS SI2304DS VISHAY SOT-23	Q1		1
106	#N/A	20.TH63LV1	IC THC63LVDM83A 85MHZ LVDS TSSOP	U13,U14		2
107	#N/A	21.24LC1.601	IC EEPROM 24LC16B/SN M 2K*8 BIT IIC BUS 8SO	U10		1
108	#N/A	22.62701.005	PROGRAMMED IC VG710 "GM5120 AU-EG01V0"			1
109	#N/A	21.Pm39L.V01	IC Pm39LV010 CMOS Flash memory 1Megabit(128			1
110	#N/A	39.62701.005	FW BIOS SOURCE CODE "GM5120 AU-EG01V0"			1
111	#N/A	35.00017.001	LABEL BIOS 13*11mm BLANK			1
112	#N/A	35.00018.001	LABEL BARCODE 13*26.5mm BLANK			2
113	#N/A	35.59907.001	LABEL SPEC ASIC 13*11mm BLANK For VIEWSONIC			1
114	#N/A	61.00039.001	EYELET BR f 3*4.0			2
115	#N/A	61.59901.001	SHIELDING PLATE DVI T-PLATE 0.3t			1
116	B-CB-0206-0165	80.62702.001	PCBA CTRL BD VG710	CONTROL BOARD		1
117	#N/A	00.62701.A01	BARE PCB L:2 CTRL BD VG710			1
118	#N/A	09.LTL1B.ED1	DIODE LED 3mm Yellow/Green LTL-1BEDJ			1
119	#N/A	11.122M2.302	CNNT M 12P 2mm RT/LEAD P-220-2*6-R			1
120	#N/A	35.00016.001	LABEL BARCODE 6*38mm BLANK			1
121	#N/A	43.52102.002	SWITCH PUSH PT-002-B2 DC12V 50mA	SW1,SW2,SW3,SW4,SW5, W5,SW7,SW8		8
122	M-MS-0808-6287	85.005AG.075	SCREW HEX I/O #4-40*H5*L7.5 Ni NYLOK			4
123	M-SCW-0824-0651	85.1F123.060	SCREW PAN MECH W/SF M3*6 Ni			19
124	M-SCW-0824-6753	85.4A323.040	SCREW FLATE MECH M3*4 BLACK			2
125	M-SCW-0824-6756	85.TA123.080	SCREW CAP TAP M3*8 Ni			4
126	M-SCW-0824-6755	85.UA123.080	DOUBLE THREADS SCREW PAN TAP M3*8 Ni			3
127	M-CV-0830-2480	51.62706.001	BASE COVER ABS HB-VS06 VG710s	BASE COVER		1
128	M-MS-0808-8970	51.62707.001	FRONT ARM ABS HB-VS06 VG710s	FRONT ARM		1
129	M-MS-0808-8971	51.62708.001	REAR ARM ABS HB-VS06 VG710s	REAR ARM		1
130	M-MS-0808-9645	52.62703.001	RUBBER FOOT 35*10*1.2t VG710	RUBBER FOOT		5
131	M-MS-0808-8960	61.62703.001	BASE PLATE SPCC-Zn 2.5t VG710s	BASE PLATE		1
132	M-MS-0808-8961	61.62704.001	HINGE SPCC-Zn 2.0t VG710s	HINGE		1
133	M-SCW-0824-6757	85.1F124.120	SCREW PAN MECH W/SF M4*12 Ni			4
134	M-SCW-0824-6754	85.4A524.080	SCREW FLAT MECH W/O M4*8 NYLOK			4
135	M-SCW-0824-6755	85.UA123.080	DOUBLE THREADS SCREW PAN TAP M3*8 Ni			1
136	M-SCW-0824-6872	85.YA123.070	SCREW FLAT TAP M3*7 Ni			4
137	M-LB-0813-1017	35.59906.001	LABEL 210*65mm BLANK FOR PALLET			0.063
138	#N/A	51.00069.001	PACKING STRAP 12MM*2000M*0.6MM			0.023
139	#N/A	51.00070.001	PE STRETCH FILM 500MM*1500M*0.02MM			3E-04
140	#N/A	51.00080.001	3 INCH TRANSPARENT ADHESIVE TAPE (600M)			0.002
141	#N/A	55.55103.001	CORNER BOARD 40*40*5*1050mm			0.063
142	#N/A	55.57202.001	CORNER BOARD 40*40*5*960mm			0.063
143	#N/A	55.58303.002	CORNER BOARD 40*40*5*2120mm VG700-1			0.125
144	#N/A	55.62702.001	COVER PALLET AB FLUTE 112.5*95*0.7cm FOR VG			0.031
145	#N/A	58.62701.001	WOOD PALLET 1125*950*130 VG710s			0.031
146	M-LB-0813-0706	35.58203.001	LABEL CARTON 76*76mm			1
147	A-CD-VG712S	36.62701.007	USER GUIDE+CD VG712s TCO'03	USER GUIDE		1
148	A-VC-0101-0261	42.59901.003	CABLE VGA 15P 1800mm 2*25mm CORE	VGA CABLE		1
149	A-AU-0120-0032	42.59903.001	CABLE AUDIO 1.8M LM/BK/LM VX2000	AUDIO CABLE		1
150	M-MS-0808-9642	51.62710.001	PE BAG LDPE 450*700*0.07t W/HOLE VG710	PE BAG		1
151	P-BX-0601-0991	55.62701.003	CARTON AB-18 455*205*480(h) VG712s	CARTON		1
152	P-FM-0602-0818	56.62701.001	CUSHION R EPS VG710s	CUSHION		1
153	P-FM-0602-0819	56.62702.001	CUSHION L EPS VG710s	CUSHION		1

8. Exploded Diagram And Spare Parts List

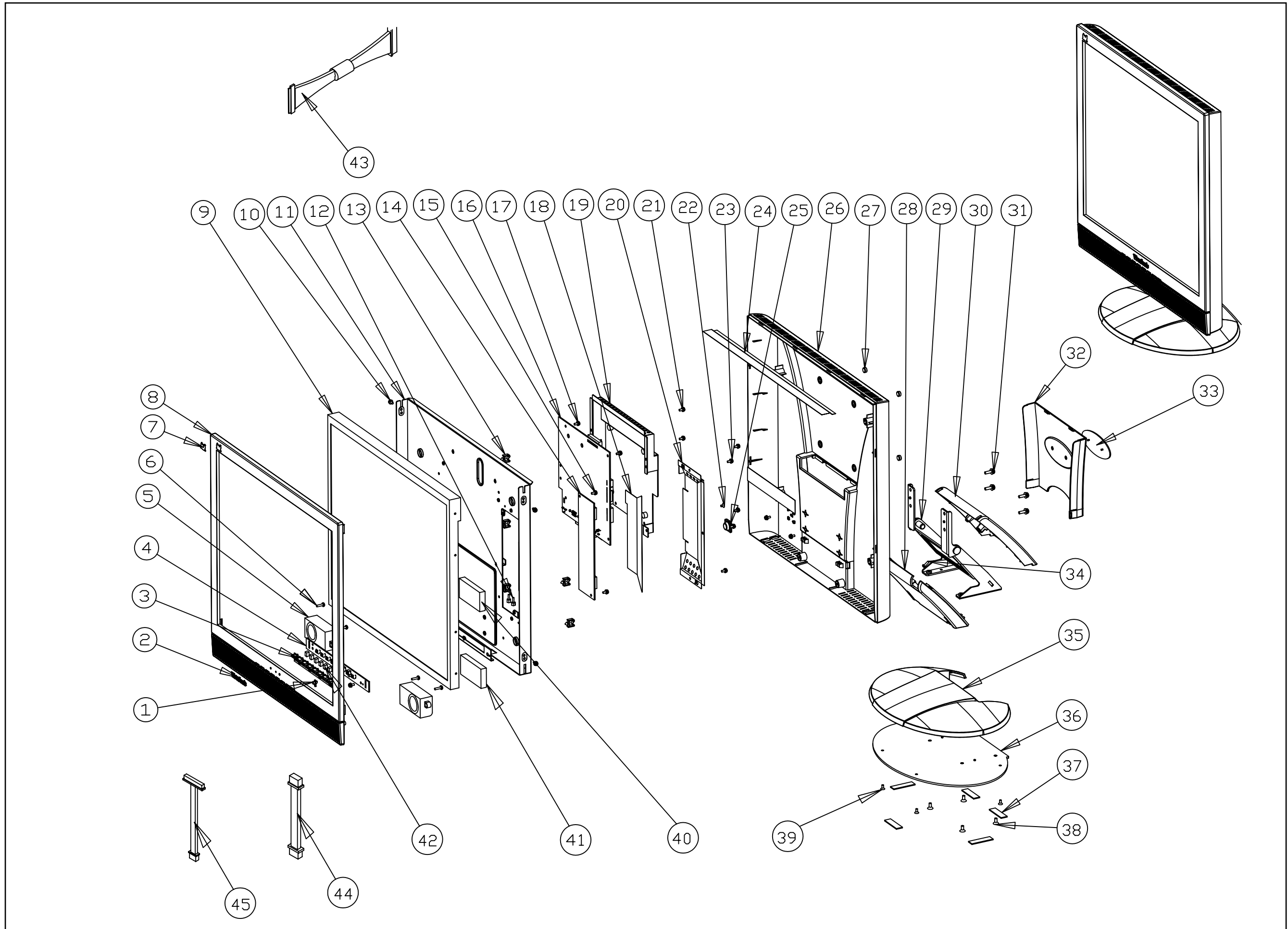

EXPLODED PARTS LIST (VG712b-1)

ViewSonic Model Number: VLCD523719

Rev: 1a

Item	ViewSonic P/N	Ref. P/N	Description	Q'ty
1	M-MS-0808-8973	51.62705.001	LED LENS PMMA VG710s	1
2	M-MS-0808-8948	35.62704.001	ViewSonic AL-LOGO E015-016-1 ViewSonic	1
3	PL-BT-0706-0149	51.62704.001	SELECT BUTTON ABS HB-Cr VG710s	1
4	B-CB-0206-0165	80.62702.001	PCBA CTRL BD VG710	1
5	E-SK-0412-0080	49.62701.001	SPEAKER 3W FOR VG710	1
6	M-SCW-0824-6756	85.TA123.080	SCREW CAP TAP M3*8 Ni	4
7	M-MS-0808-8946	35.62702.001	BIRD LOGO AL E015-006 VG710s	1
8	C-00000212	51.62701.004	FRONT COVER ABS HB-CR VG712b	1
9	M-LCD-0826-0256	48.62701.004	TFT LCD 17" AUO M170EG01 V.0	1
10	M-SCW-0824-0651	85.1F123.060	SCREW PAN MECH W/SF M3*6 Ni	4
11	M-BK-0805-0021	61.62701.001	LCD BRKT SECC 1.0t VG710s	1
12	M-MS-0808-6287	85.005AG.075	SCREW HEX I/O #4-40*H5*L7.5 Ni NYLOK	4
13	M-MS-0808-8953	51.59907.001	WIRE MOUNT MC-03A "G&A" VX930	5
14	B-SB-0221-0700	44.58402.002	PCBA INVERTER;EMAX FOR 17" AUO M170EG01 V0	1
15	M-SCW-0824-0651	85.1F123.060	SCREW PAN MECH W/SF M3*6 Ni	2
16	B-MB-0201-2734	80.62701.005	PCBA MAIN BD VG710 "GM5120 AU-EG01V0"	1
17	M-SCW-0824-0651	85.1F123.060	SCREW PAN MECH W/SF M3*6 Ni	3
18	M-MS-0808-8750	51.61103.001	MYLAR ADHESIVEt=0.3mm VP171	1
19	M-BK-0805-0022	61.62702.001	SHIELDING BRKT-MB SECC 1.0t VG710s	1
20	M-BK-0805-0020	61.61102.002	SHIELDING BRKT-INV TINEPLATE 0.3t VG710s	1
21	M-SCW-0824-0651	85.1F123.060	SCREW PAN MECH W/SF M3*6 Ni	5
22	M-SCW-0824-6753	85.4A323.040	SCREW FLATE MECH M3*4 BLACK	2
23	M-SCW-0824-0651	85.1F123.060	SCREW PAN MECH W/SF M3*6 Ni	3
24	M-MS-0808-8949	41.58301.001	EMI TAPE 80773 25*75mm	1
25	M-BK-0805-0023	61.00042.001	LOCK BRKT+CAP SECC 0.8t	1
26	M-CV-0830-2630	51.62702.002	REAR COVER ABS HB-VS08 VG710b	1
27	M-MS-0808-8959	52.62701.002	VESA RUBBER PAD D7.0*H4.5 VG710b	4
28	M-MS-0808-8955	51.62707.002	FRONT ARM ABS HB-VS08 VG710b	1
29	M-MS-0808-8961	61.62704.001	HINGE SPCC-Zn 2.0t VG710s	1
30	M-MS-0808-8956	51.62708.002	REAR ARM ABS HB-VS08 VG710b	1
31	M-SCW-0824-6757	85.1F124.120	SCREW PAN MECH W/SF M4*12 Ni	4
32	M-MS-0808-8954	51.62703.002	HINGE CAP ABS HB-VS08 VG710b	1
33	M-MS-0808-8299	51.58711.002	NAMEPLATE ELLIPSE CS-VS08 ViewSonic	1
34	M-SCW-0824-6755	85.UA123.080	DOUBLE THREADS SCREW PAN TAP M3*8 Ni	1
35	M-CV-0830-2479	51.62706.002	BASE COVER ABS HB-VS08 VG710b	1
36	M-MS-0808-8960	61.62703.001	BASE PLATE SPCC-Zn 2.5t VG710s	1
37	M-MS-0808-9645	52.62703.001	RUBBER FOOT 35*10*1.2t VG710	5
38	M-SCW-0824-6754	85.4A524.080	SCREW FLAT MECH W/O M4*8 NYLOK	4
39	M-SCW-0824-6872	85.YA123.070	SCREW FLAT TAP M3*7 Ni	4
40	M-MS-0808-9646	52.62703.002	RUBBER 30*15*4 BLACK VG710	1
41	M-MS-0808-9644	52.62702.001	RUBBER SPACER 20*10*5.5mm	4
42	M-MS-0808-7882	52.62707.001	SPONGE 8.0L*6.0W*8.0H VG712s	6
43	CB-00000213	42.62701.A01	W.A. 30P UL1007 #24 225mm VG710(COST)-CMO	1
44	M-WR-0828-6010	42.58303.001	W.A. 12P UL1571 #28 260mm W/O CORE SHARE(MB	1
45	M-WR-0828-0636	42.58301.001	W.A. 10/6P UL1007 #24 100mm VG700(INV)	1

EXPLODED PARTS LIST (VG712s-1)

ViewSonic Model Number: VLCD823719

Rev 1b

Item	ViewSonic P/N	Ref. P/N	Description	Q'ty
1	M-MS-0808-8973	51.62705.001	LED LENS PMMA VG710s	1
2	M-MS-0808-8948	35.62704.001	ViewSonic AL-LOGO E015-016-1 ViewSonic	1
3	PL-BT-0706-0149	51.62704.001	SELECT BUTTON ABS HB-Cr VG710s	1
4	B-CB-0206-0165	80.62702.001	PCBA CTRL BD VG710	1
5	E-SK-0412-0080	49.62701.001	SPEAKER 3W FOR VG710	1
6	M-SCW-0824-6756	85.TA123.080	SCREW CAP TAP M3*8 Ni	4
7	M-MS-0808-8946	35.62702.001	BIRD LOGO AL E015-006 VG710s	1
8	C-FP-0301-1037	51.62701.003	FRONT COVER ABS HB-CR VG712s	1
9	M-LCD-0826-0256	48.62701.004	TFT LCD 17" AUO M170EG01 V.0	1
10	M-SCW-0824-0651	85.1F123.060	SCREW PAN MECH W/SF M3*6 Ni	4
11	M-BK-0805-0021	61.62701.001	LCD BRKT SECC 1.0t VG710s	1
12	M-MS-0808-6287	85.005AG.075	SCREW HEX I/O #4-40*H5*L7.5 Ni NYLOK	4
13	M-MS-0808-8953	51.59907.001	WIRE MOUNT MC-03A "G&A" VX930	5
14	B-SB-0221-0700	44.58402.002	PCBA INVERTER;EMAX FOR 17" AUO M170EG01 V0	1
15	M-SCW-0824-0651	85.1F123.060	SCREW PAN MECH W/SF M3*6 Ni	2
16	B-MB-0201-2734	80.62701.005	PCBA MAIN BD VG710 "GM5120 AU-EG01V0"	1
17	M-SCW-0824-0651	85.1F123.060	SCREW PAN MECH W/SF M3*6 Ni	3
18	M-MS-0808-8750	51.61103.001	MYLAR ADHESIVEt=0.3mm VP171	1
19	M-BK-0805-0022	61.62702.001	SHIELDING BRKT-MB SECC 1.0t VG710s	1
20	M-BK-0805-0020	61.61102.002	SHIELDING BRKT-INV TINEPLATE 0.3t VG710s	1
21	M-SCW-0824-0651	85.1F123.060	SCREW PAN MECH W/SF M3*6 Ni	5
22	M-SCW-0824-6753	85.4A323.040	SCREW FLATE MECH M3*4 BLACK	2
23	M-SCW-0824-0651	85.1F123.060	SCREW PAN MECH W/SF M3*6 Ni	3
24	M-MS-0808-8949	41.58301.001	EMI TAPE 80773 25*75mm	1
25	M-BK-0805-0023	61.00042.001	LOCK BRKT+CAP SECC 0.8t	1
26	C-BC-0302-0541	51.62702.001	REAR COVER ABS HB-VS06 VG710s	1
27	M-MS-0808-8972	52.62701.001	VESA RUBBER PAD D7.0*H4.5 VG710s	4
28	M-MS-0808-8970	51.62707.001	FRONT ARM ABS HB-VS06 VG710s	1
29	M-MS-0808-8961	61.62704.001	HINGE SPCC-Zn 2.0t VG710s	1
30	M-MS-0808-8971	51.62708.001	REAR ARM ABS HB-VS06 VG710s	1
31	M-SCW-0824-6757	85.1F124.120	SCREW PAN MECH W/SF M4*12 Ni	4
32	M-MS-0808-8969	51.62703.001	HINGE CAP ABS HB-VS06 VG710s	1
33	M-MS-0808-8116	51.58711.001	NAMEPLATE ELLIPSE ViewSonic	1
34	M-SCW-0824-6755	85.UA123.080	DOUBLE THREADS SCREW PAN TAP M3*8 Ni	1
35	M-CV-0830-2480	51.62706.001	BASE COVER ABS HB-VS06 VG710s	1
36	M-MS-0808-8960	61.62703.001	BASE PLATE SPCC-Zn 2.5t VG710s	1
37	M-MS-0808-9645	52.62703.001	RUBBER FOOT 35*10*1.2t VG710	5
38	M-SCW-0824-6754	85.4A524.080	SCREW FLAT MECH W/O M4*8 NYLOK	4
39	M-SCW-0824-6872	85.YA123.070	SCREW FLAT TAP M3*7 Ni	4
40	M-MS-0808-9646	52.62703.002	RUBBER 30*15*4 BLACK VG710	1
41	M-MS-0808-9644	52.62702.001	RUBBER SPACER 20*10*5.5mm	4
42	M-MS-0808-7882	52.62707.001	SPONGE 8.0L*6.0W*8.0H VG712s	6
43	CB-00000213	42.62701.A01	W.A. 30P UL1007 #24 225mm VG710(COST)-CMO	1
44	M-WR-0828-6010	42.58303.001	W.A. 12P UL1571 #28 260mm W/O CORE SHARE(MB)	1
45	M-WR-0828-0636	42.58301.001	W.A. 10/6P UL1007 #24 100mm VG700(INV)	1

Packing for shipping

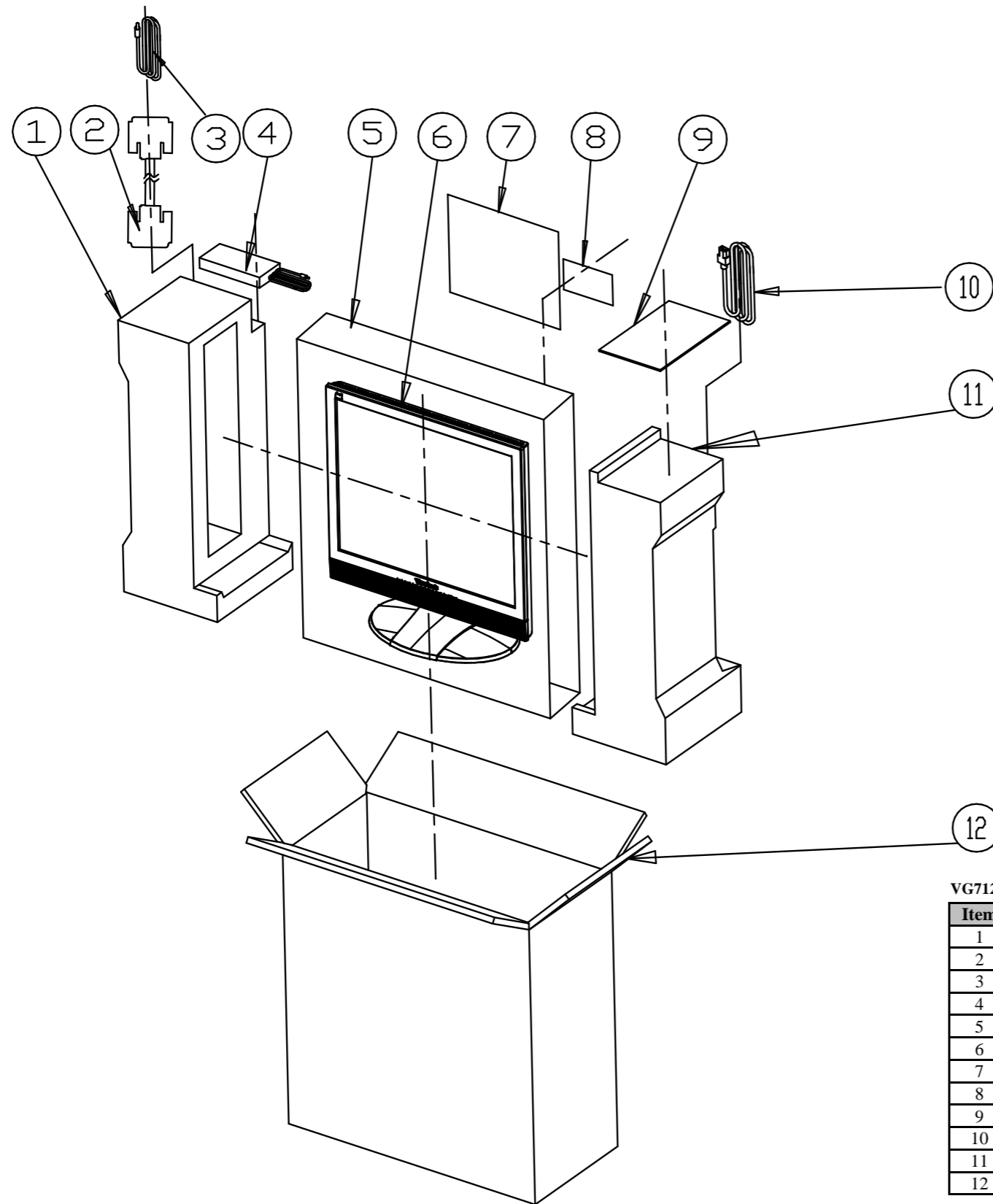

VG712s-1 PPL

Item	ViewSonic P/N	Ref. P/N	Description	Q'ty
1	P-FM-0602-0819	56.62702.001	CUSHION L EPS VG710s	1
2	A-VC-0101-0261	42.59901.003	CABLE VGA 15P 1800mm 2*25mm CORE	1
3	A-AU-0120-0032	42.59903.001	CABLE AUDIO 1.8M LM/BK/LM VX2000	1
4	A-AD-0114-0204	47.62701.001	ADAPTER IN100-240V 12V/3.33A;"LSE"	1
5	M-MS-0808-9642	51.62710.001	PE BAG LDPE 450*700*0.07t W/HOLE VG710	1
6	E-00000214	DC.62701.013	D.C. VG712b;AUO TWO-TONE TCO99	1
7	M-LB-0830-0733	35.62701.005	LABEL SPEC 120*50mm VG712b TCO99	1
8	M-LB-0813-0736	35.58304.001	LABEL BARCODE 40*14 ViewSonic	1
9	A-CD-VG712B	36.62701.008	USER GUIDE+CD VG712b TCO'99	1
10	A-PC-0106-0270	42.57207.001	CABLE POWER CORD 1.8M±0.1M UNSHIELD (NA)	1
11	P-FM-0602-0818	56.62701.001	CUSHION R EPS VG710s	1
12	P-BX-0601-1087	55.62701.005	CARTON AB-18 455*205*480(h) VG712b TCO99	1

9. Block Diagram

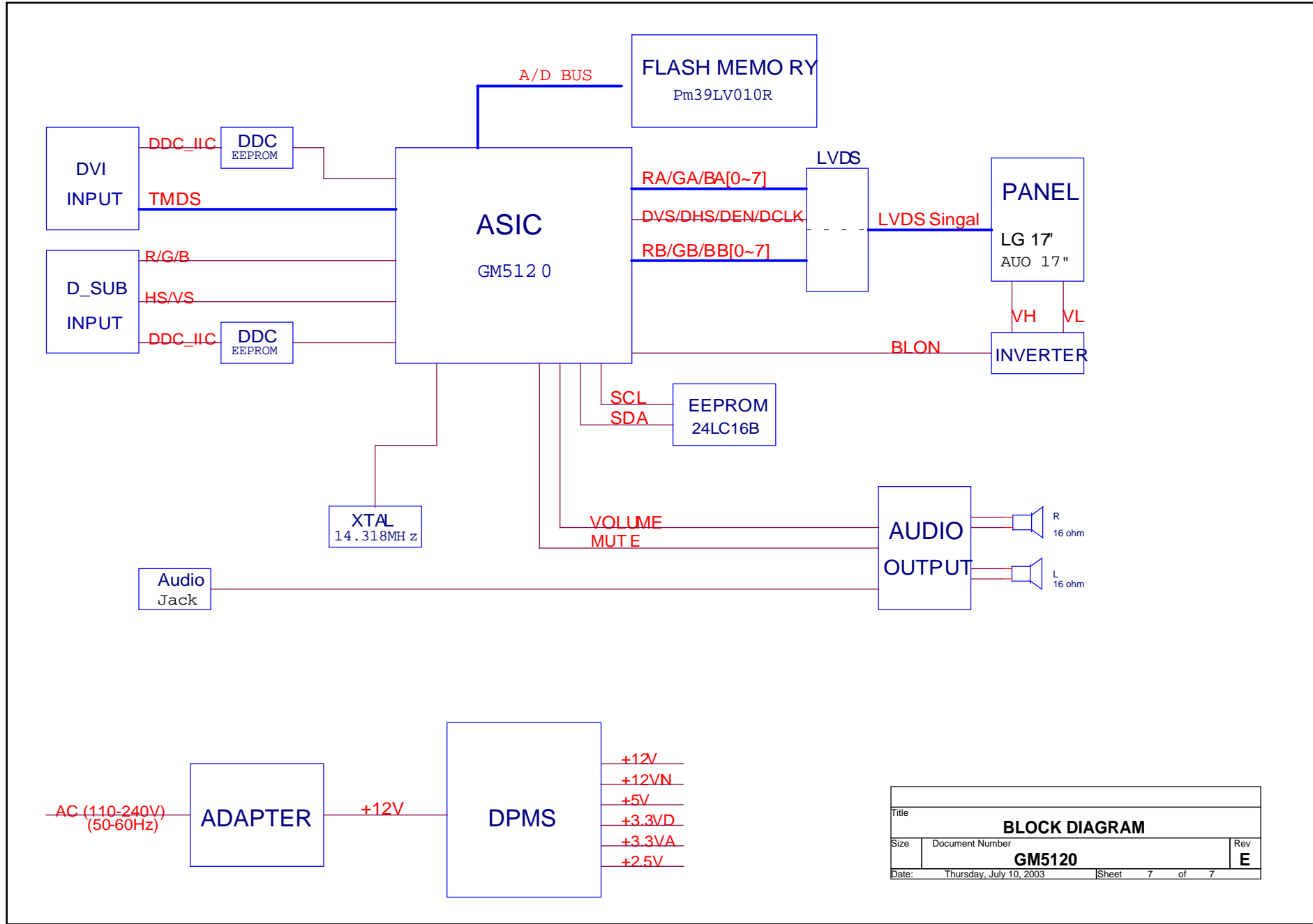

Title		
BLOCK DIAGRAM		
Size	Document Number	Rev
	GM5120	E
Date:	Thursday, July 10, 2003	Sheet 7 of 7

10. Schematic Diagrams

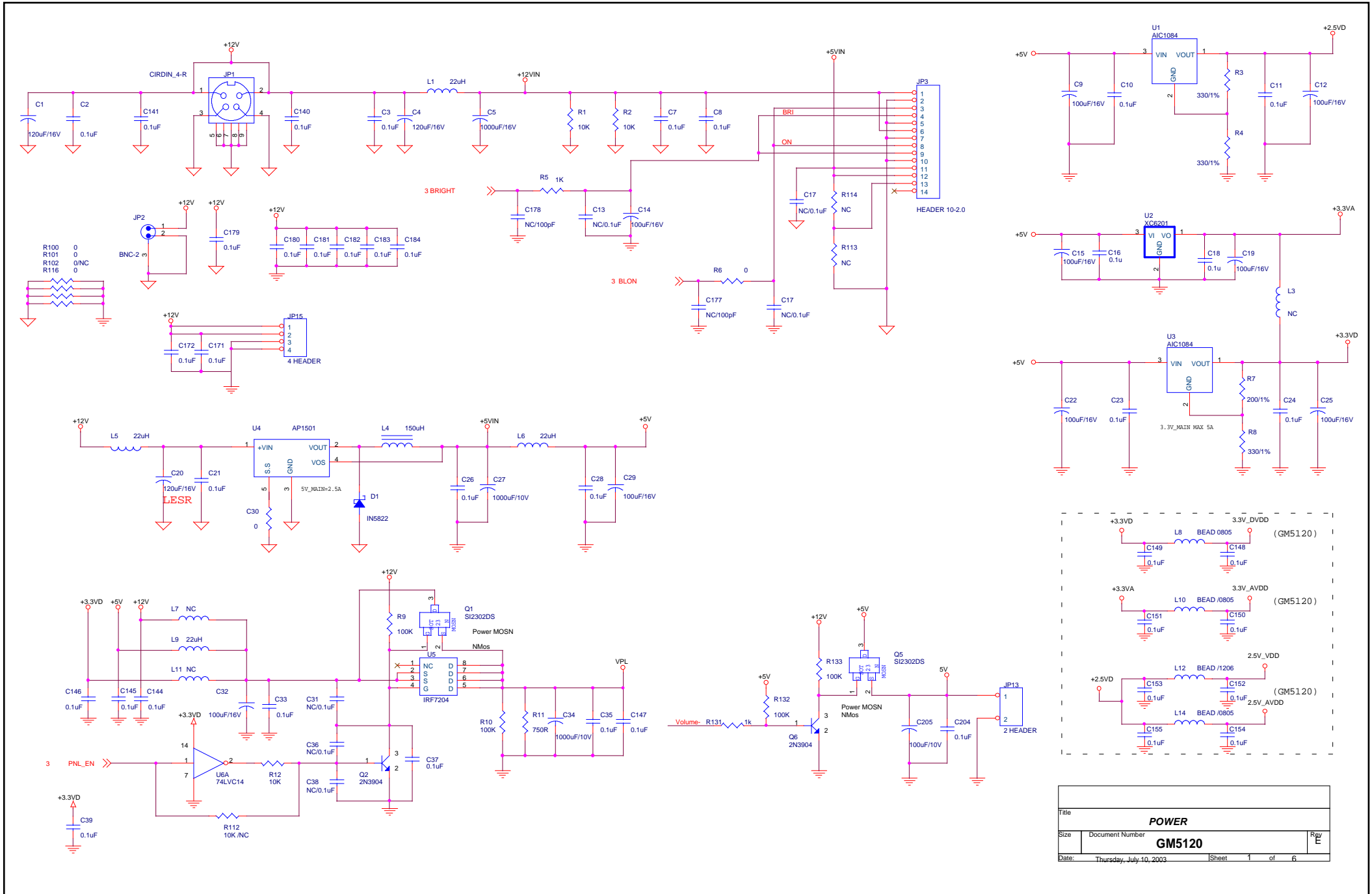

DVI Connector

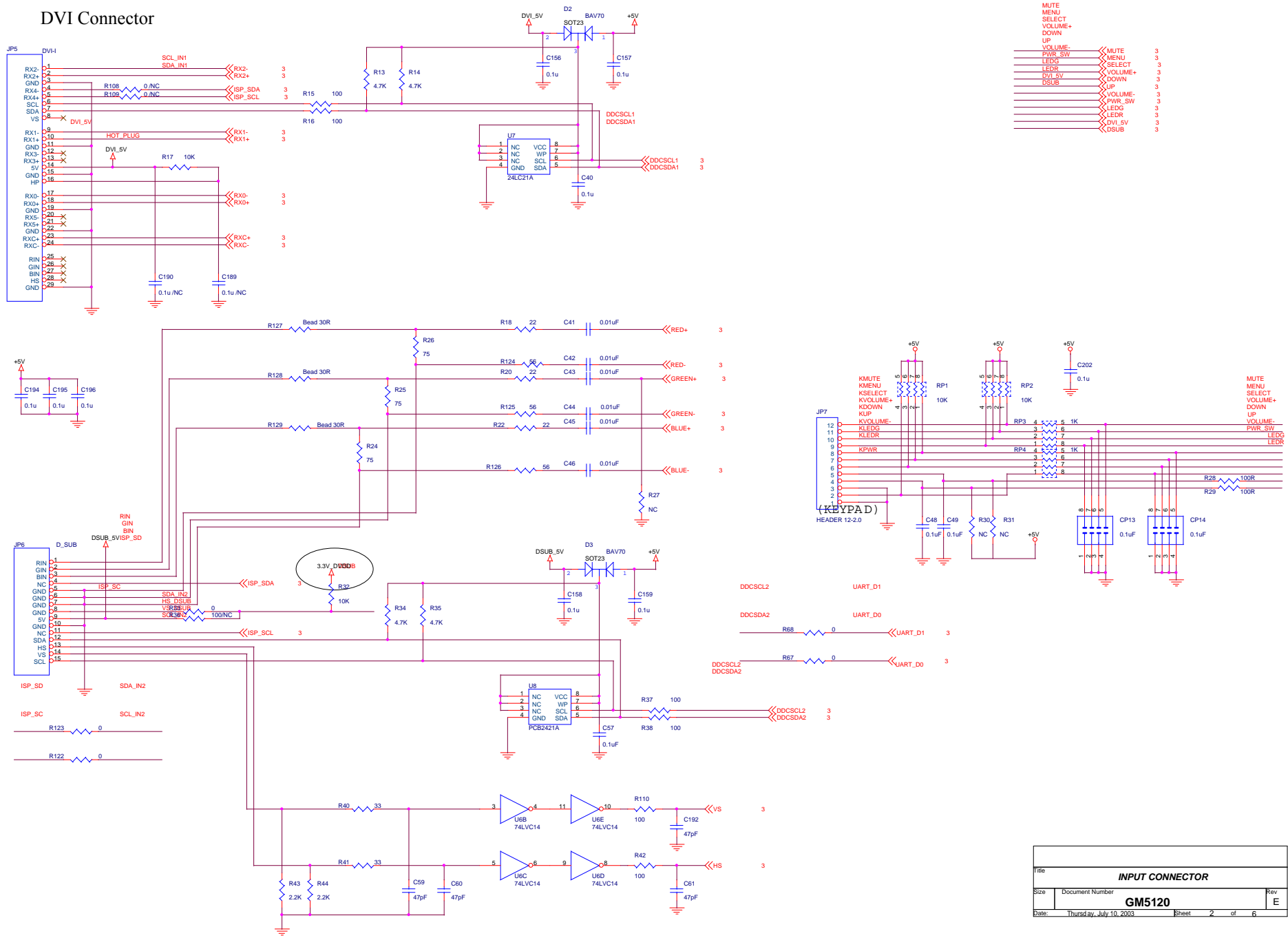

INPUT CONNECTOR		
File		
Size	Document Number	Rev
	GM5120	E
Date	Thursday, July 10, 2003	Sheet 2 of 6

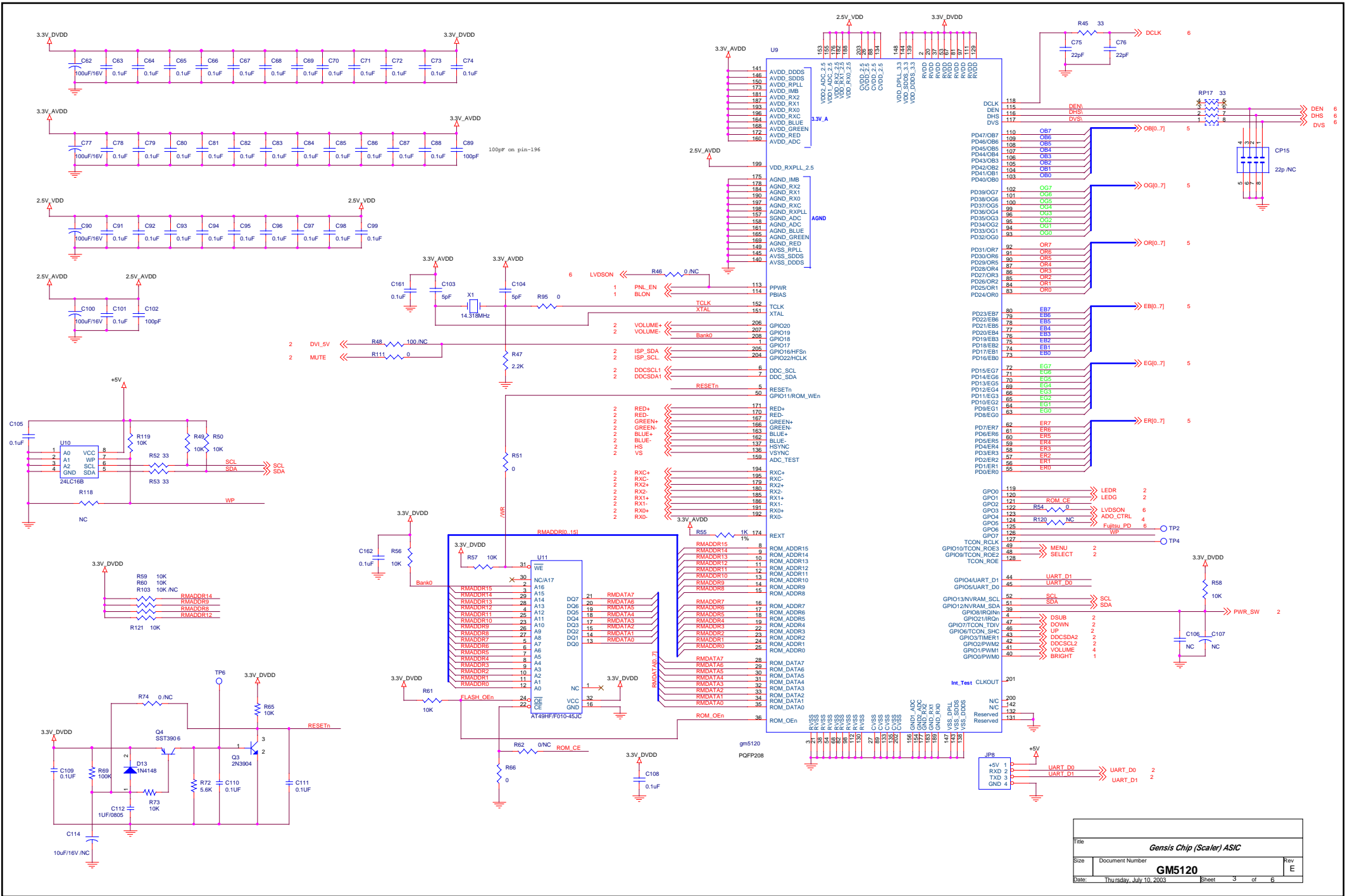

Title	Genisic Chip (Scaler) ASIC	
Size	Document Number	Rev
	GM5120	E
Date:	Thu, July 10, 2003	Sheet 3 of 6

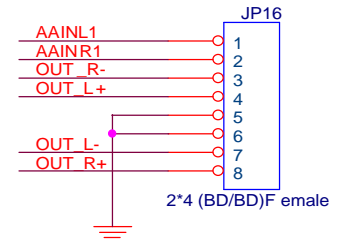
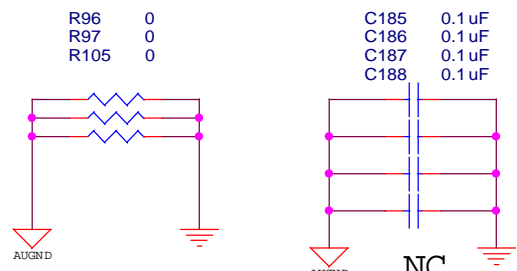
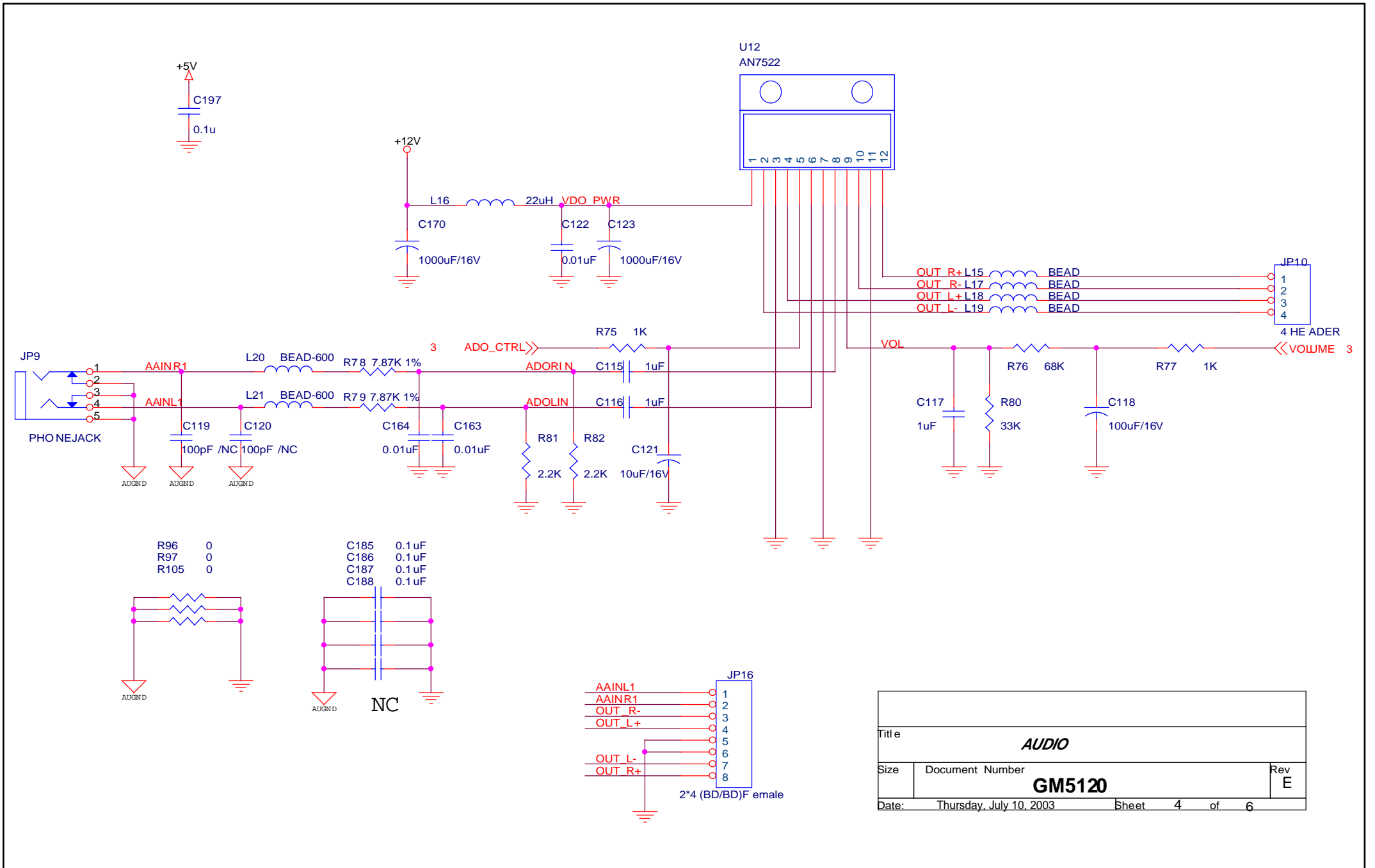

Title			AUDIO		
Size	Document Number				Rev
	GM5120				E
Date:	Thursday, July 10, 2003	Sheet	4	of	6

- 3 OB[0..7] << OB[0..7]
- 3 OG[0..7] << OG[0..7]
- 3 OR[0..7] << OR[0..7]
- 3 EB[0..7] << EB[0..7]
- 3 EG[0..7] << EG[0..7]
- 3 ER[0..7] << ER[0..7]

- DRO[0..7] >> DRO[0..7] 6
- DGO[0..7] >> DGO[0..7] 6
- DBO[0..7] >> DBO[0..7] 6
- DRE[0..7] >> DRE[0..7] 6
- DGE[0..7] >> DGE[0..7] 6
- DBE[0..7] >> DBE[0..7] 6

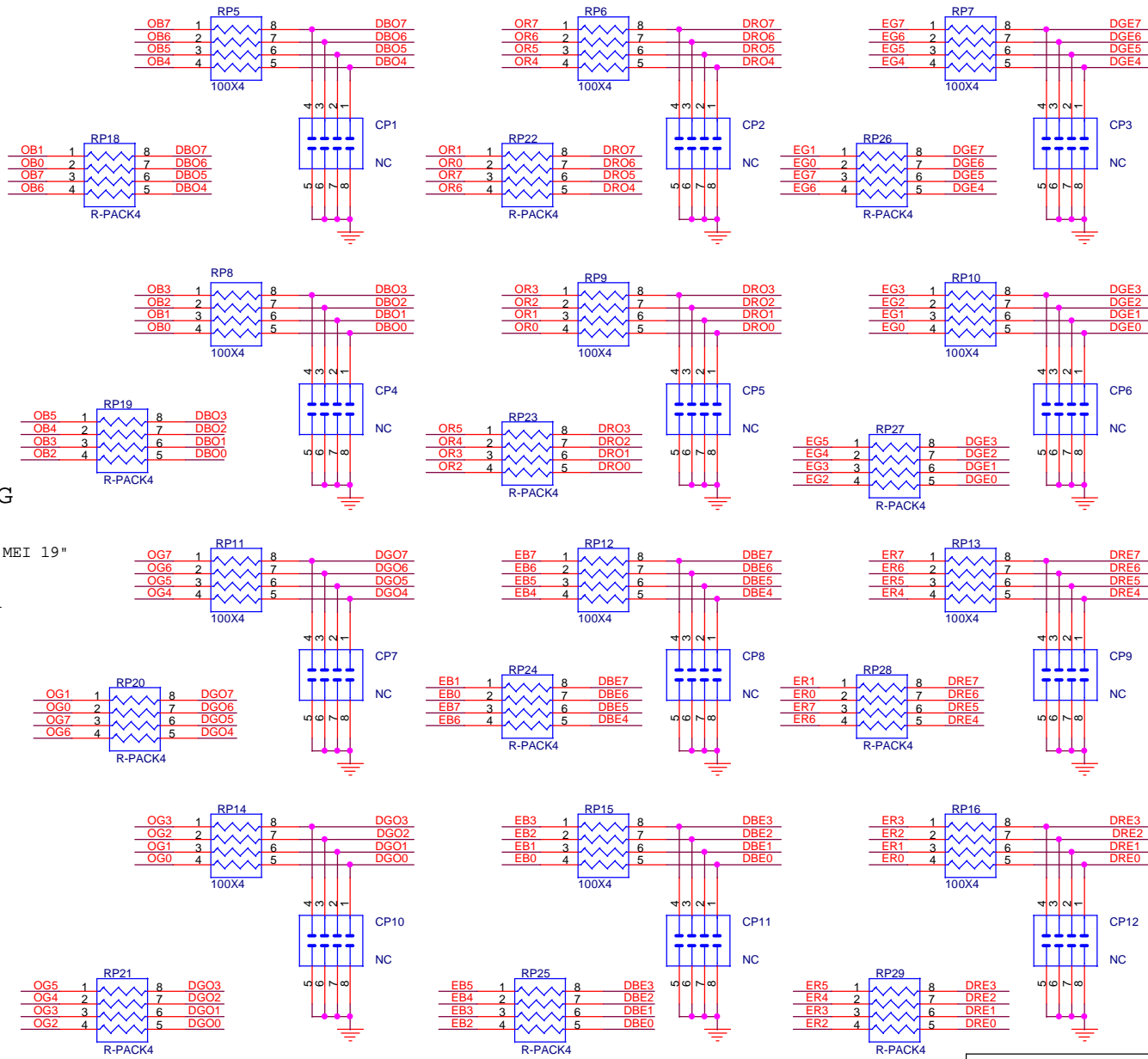

Select LVDS MAPPING

EX:RP5~RP16 for 0,1,2,3,4,5,6,7
 AUO 17",19" Samsung 17",19" CHI MEI 19"
 Fujitsu 19"-10
 EX:RP18~RP29 for 2,3,4,5,6,7,0,1
 Fujitsu 19" FLC48SXC8V-05/-10

Title		
OUTPUT INTERFACE		
Size	Document Number	Rev
	GM5120	E
Date:	Thursday, July 10, 2003	Sheet 5 of 6

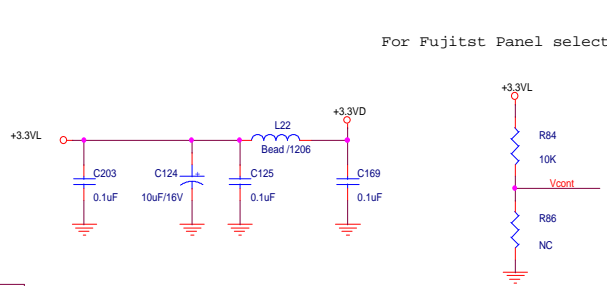
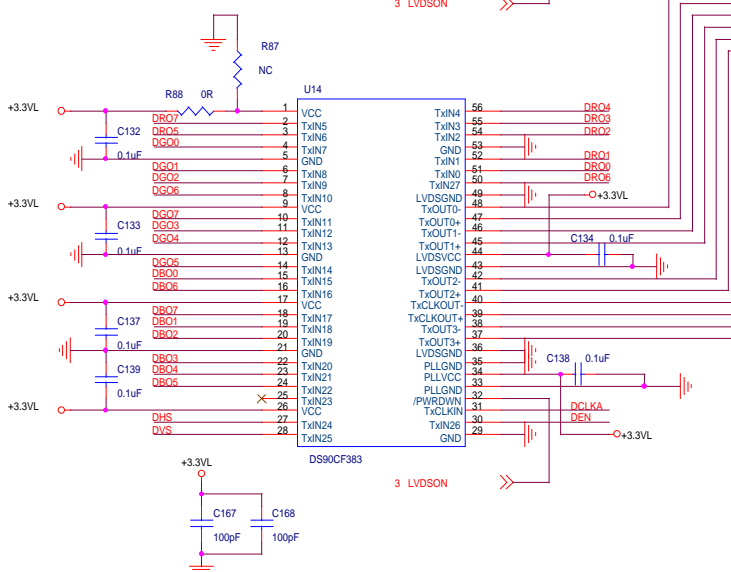
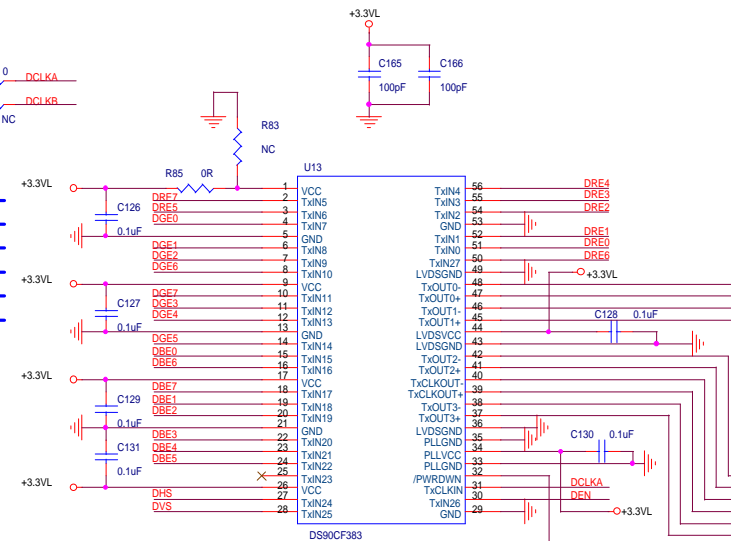
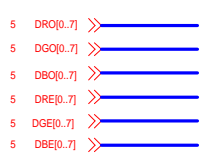
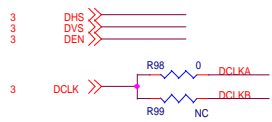

For Fujitst Panel select Lvds mapping

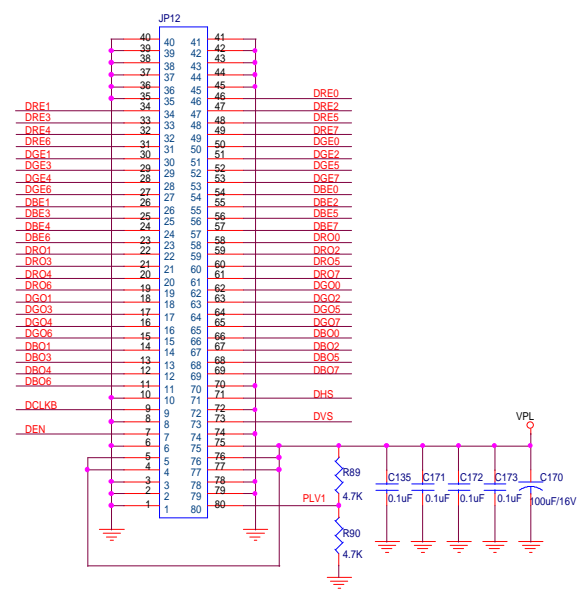
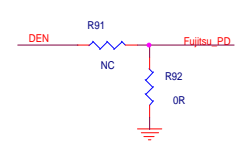
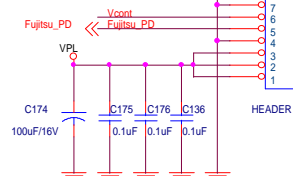
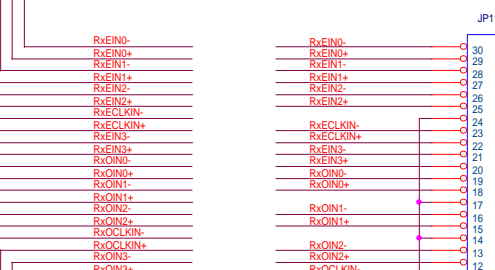
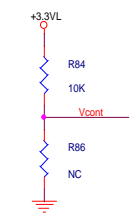

Title		
LVDS & OUTPUT CONNECTOR		
Size	Document Number	Rev
	GM5120	E
Date:	Thursday, July 10, 2003	Sheet 6 of 6

11. PCB Layout Diagrams

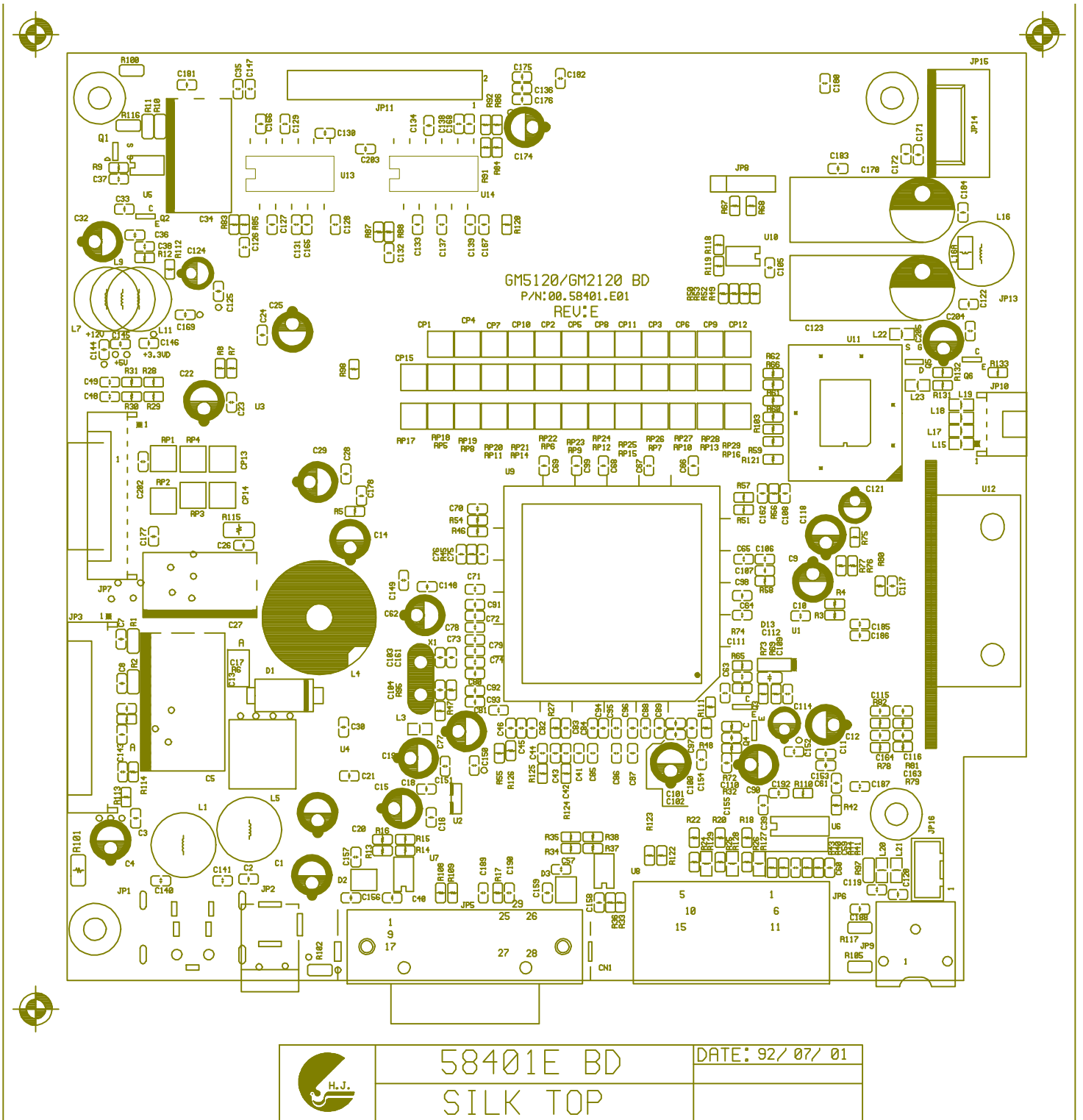

Reader's Response

Dear Readers:

Thank you in advance for your feedback on our Service Manual, which allows continuous improvement of our products. We would appreciate your completion of the Assessment Matrix below, for return to ViewSonic Corporation.

Assessment

A. What do you think about the content after reading **VG712s/b** Service Manual?

<i>Unit</i>	<i>Excellent</i>	<i>Good</i>	<i>Fair</i>	<i>Bad</i>
1. Precautions And Safety Notices				
2. Specification				
3. Front Panel Function Control Description				
4. Circuit Description				
5. Adjusting Procedure				
6. Trouble Shooting Flow Chart				
7. Recommended Spare Parts List				
8. Exploded Diagram and Spare Parts List				
9. Block Diagram				
10. Schematic Diagrams				
11. PCB Layout Diagrams				

B. Are you satisfied with the **VG712s/b** service manual?

<i>Item</i>	<i>Excellent</i>	<i>Good</i>	<i>Fair</i>	<i>Bad</i>
1. Service Manual Content				
2. Service Manual Layout				
3. The form and listing				

C. Do you have any other opinion or suggestion about this service manual?

Reader's basic data:

Name:		Title:	
Company:			
Add.:			
Tel:		Fax:	
E-mail:			

After completing this form, please return it to ViewSonic Quality Assurance in the USA at facsimile 1-909-839-7943. You may also e-mail any suggestions to the Director, Quality Systems & Processes (marc.maupin@viewsonic.com)