

Power SMD LED PLCC-4

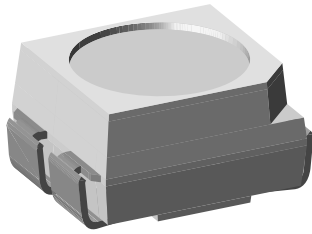

19210

DESCRIPTION

The VLM.32.. series is an advanced development in terms of heat dissipation.

The leadframe profile of this PLCC-4 SMD package is optimized to reduce the thermal resistance.

This allows higher drive current and doubles the light output compared to Vishay's high intensity SMD LED in PLCC-2 package.

PRODUCT GROUP AND PACKAGE DATA

- Product group: LED
- Package: SMD PLCC-4
- Product series: power
- Angle of half intensity: $\pm 60^\circ$

FEATURES

- Available in 8 mm tape
- High brightness SMD LED
- Luminous intensity and color categorized per packing unit
- Luminous intensity ratio per packing unit $I_{Vmax}/I_{Vmin} \leq 1.6$
- ESD-withstand voltage: Up to 2 kV according to JESD22-A114-B
- Suitable for all soldering methods according to CECC 00802 and J-STD-020
- Preconditioning according to JEDEC level 2a
- Qualified according to JEDEC moisture sensitivity level 2a
- AEC-Q101 qualified
- Compatible with IR reflow solder processes according to CECC 00802 and J-STD-020C
- Material categorization: For definitions of compliance please see www.vishay.com/doc?99912

 AUTOMOTIVE
GRADE

RoHS
COMPLIANT
HALOGEN
FREE
GREEN
(5-2008)

APPLICATIONS

- Interior and exterior lighting
- Indicator and backlighting purposes for audio, video, LCDs, switches, symbols, illuminated advertising etc.
- Illumination purpose, alternative to incandescent lamps
- General use

PARTS TABLE

PART	COLOR	LUMINOUS INTENSITY (mcd)			at I _F (mA)	WAVELENGTH (nm)			at I _F (mA)	FORWARD VOLTAGE (V)			at I _F (mA)	TECHNOLOGY
		MIN.	TYP.	MAX.		MIN.	TYP.	MAX.		MIN.	TYP.	MAX.		
VLMR32ABBB-GS08	Red	1400	-	2800	50	620	-	630	50	2.0	2.2	2.8	50	AllnGaP on Si
VLMK32ABBB-GS08	Amber	1400	-	2850	50	610	-	621	50	1.85	-	3.03	50	AllnGaP on Si
VLMY32ABBB-GS08	Yellow	1400	-	2850	50	585	588	594	50	1.85	-	3.03	50	AllnGaP on Si

ABSOLUTE MAXIMUM RATINGS (T_{amb} = 25 °C, unless otherwise specified) VLMR32.., VLMK32.., VLMY32..

PARAMETER	TEST CONDITION	SYMBOL	VALUE	UNIT
Reverse voltage ⁽¹⁾		V _R	5	V
Forward current		I _F	70	mA
Power dissipation		P _V	200	mW
Junction temperature		T _j	125	°C
Operating temperature range		T _{amb}	- 40 to + 100	°C
Storage temperature range		T _{stg}	- 40 to + 100	°C
Thermal resistance junction/ambient	Mounted on PC board FR4	R _{thJA}	290	K/W

Note

⁽¹⁾ Driving the LED in reverse direction is suitable for short term application



OPTICAL AND ELECTRICAL CHARACTERISTICS (T_amb = 25 °C, unless otherwise specified)
VLMR32.., RED

Table with 7 columns: PARAMETER, TEST CONDITION, SYMBOL, MIN., TYP., MAX., UNIT. Rows include Luminous intensity, Dominant wavelength, Angle of half intensity, Spectral bandwidth at 50 % I_rel max., Forward voltage, and Reverse current.

Notes

- (1) In one package unit I_Vmax./I_Vmin. ≤ 1.6
(2) Forward voltages are tested at a current pulse duration of 1 ms and a tolerance of ± 0.1 V

OPTICAL AND ELECTRICAL CHARACTERISTICS (T_amb = 25 °C, unless otherwise specified)
VLMK32.., AMBER

Table with 7 columns: PARAMETER, TEST CONDITION, SYMBOL, MIN., TYP., MAX., UNIT. Rows include Luminous intensity, Dominant wavelength, Angle of half intensity, Spectral bandwidth at 50 % I_rel max., Forward voltage, and Reverse current.

Notes

- (1) In one package unit I_Vmax./I_Vmin. ≤ 1.6
(2) Forward voltages are tested at a current pulse duration of 1 ms and a tolerance of ± 0.1 V

OPTICAL AND ELECTRICAL CHARACTERISTICS (T_amb = 25 °C, unless otherwise specified)
VLMY32.., YELLOW

Table with 7 columns: PARAMETER, TEST CONDITION, SYMBOL, MIN., TYP., MAX., UNIT. Rows include Luminous intensity, Dominant wavelength, Angle of half intensity, Spectral bandwidth at 50 % I_rel max., Forward voltage, and Reverse current.

Notes

- (1) In one package unit I_Vmax./I_Vmin. ≤ 1.6
(2) Forward voltages are tested at a current pulse duration of 1 ms and a tolerance of ± 0.1 V

LUMINOUS INTENSITY CLASSIFICATION

Table with 3 columns: GROUP, LUMINOUS INTENSITY (mcd) MIN., LUMINOUS INTENSITY (mcd) MAX. Rows include AB, BA, BB.

Note

- Luminous intensity is tested at a current pulse duration of 25 ms and an accuracy of ± 11 %. The above type numbers represent the order groups which include only a few brightness groups. Only one group will be shipped on each reel (there will be no mixing of two groups on each reel). In order to ensure availability, single brightness groups will not be orderable. In a similar manner for colors where wavelength groups are measured and binned, single wavelength groups will be shipped in any one reel. In order to ensure availability, single wavelength groups will not be orderable.

COLOR CLASSIFICATION

Table with 5 columns: GROUP, YELLOW MIN., YELLOW MAX., AMBER MIN., AMBER MAX. Rows include W, X, Y, Z.

Note

- Wavelengths are tested at a current pulse duration of 25 ms and an accuracy of ± 1 nm.

CROSSING TABLE

Table with 2 columns: VISHAY, OSRAM. Rows include VLMK32ABBB-GS08, VLMY32ABBB-GS08, LAE6SF-AABB, LYE6SF-AABB.

TYPICAL CHARACTERISTICS ($T_{amb} = 25\text{ }^{\circ}\text{C}$, unless otherwise specified)

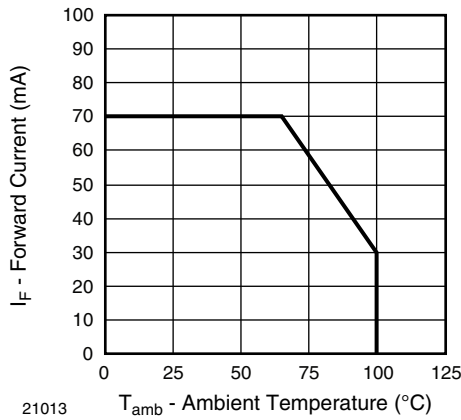

Fig. 1 - Forward Current vs. Ambient Temperature

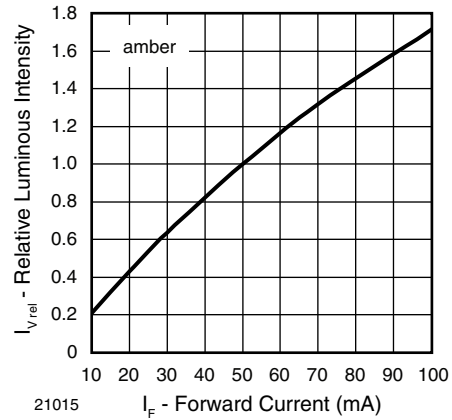

Fig. 4 - Relative Luminous Intensity vs. Forward Current

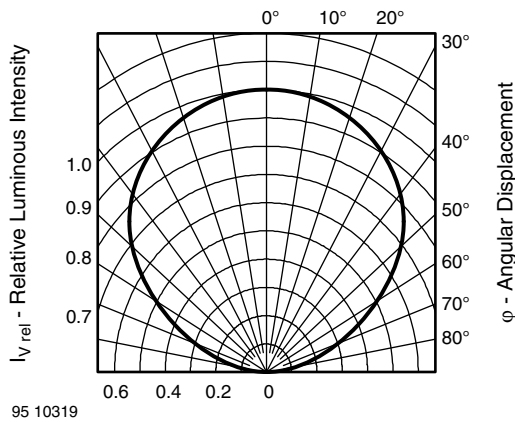

Fig. 2 - Relative Luminous Intensity vs. Angular Displacement

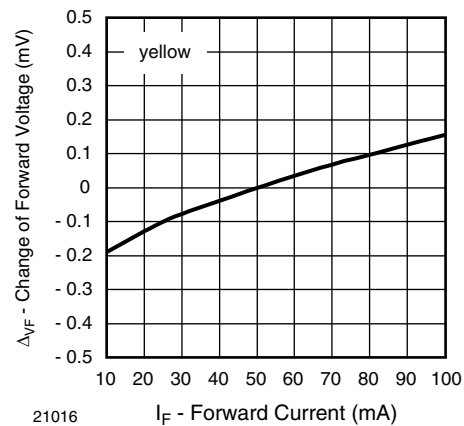

Fig. 5 - Change of Forward Voltage vs. Forward Current

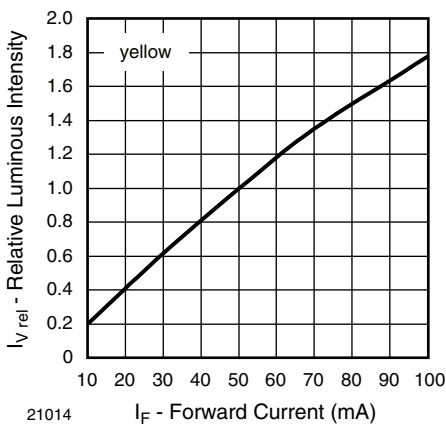

Fig. 3 - Relative Luminous Intensity vs. Forward Current

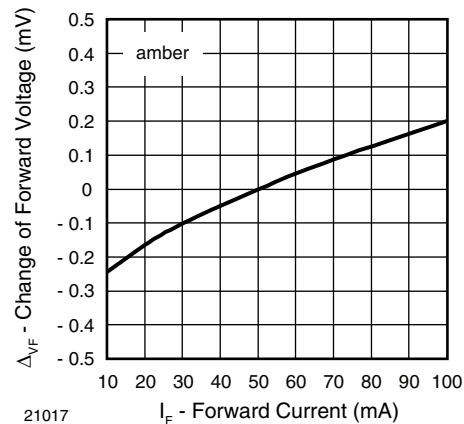

Fig. 6 - Change of Forward Voltage vs. Forward Current

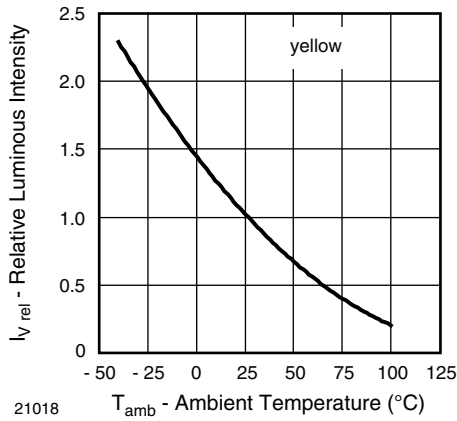

Fig. 7 - Relative Luminous Intensity vs. Ambient Temperature

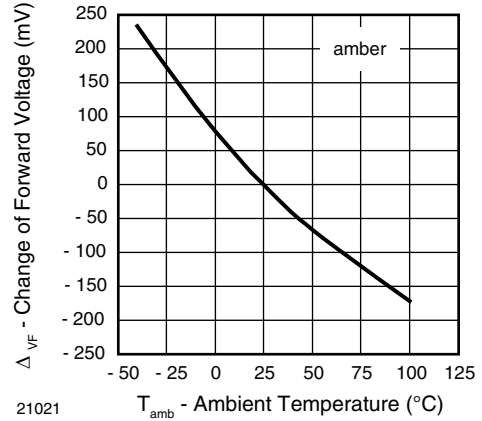

Fig. 10 - Change of Forward Voltage vs. Ambient Temperature

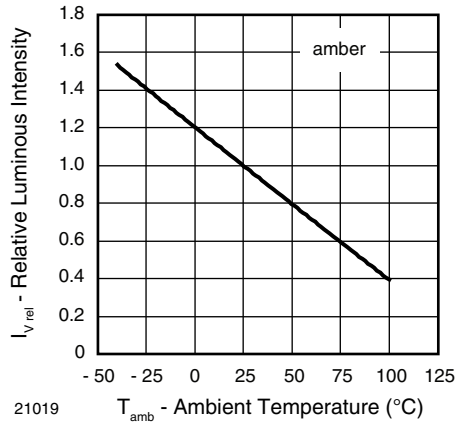

Fig. 8 - Relative Luminous Intensity vs. Ambient Temperature

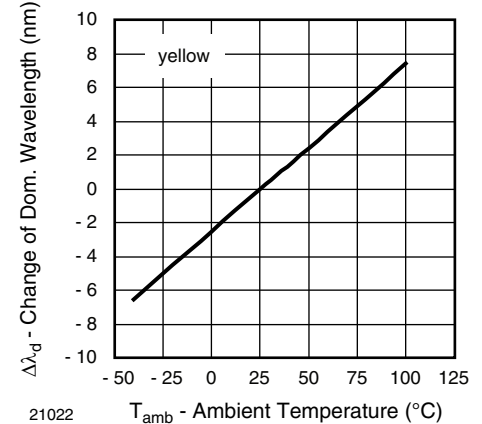

Fig. 11 - Change of Dominant Wavelength vs. Ambient Temperature

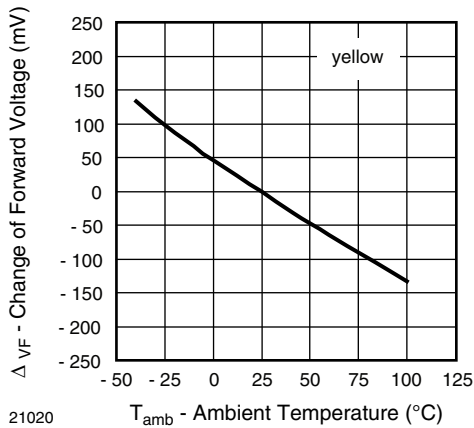

Fig. 9 - Change of Forward Voltage vs. Ambient Temperature

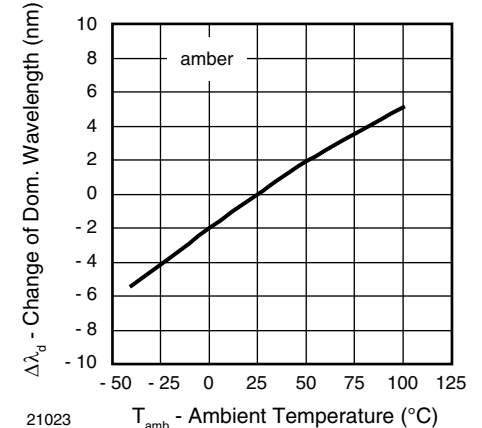

Fig. 12 - Change of Dominant Wavelength vs. Ambient Temperature

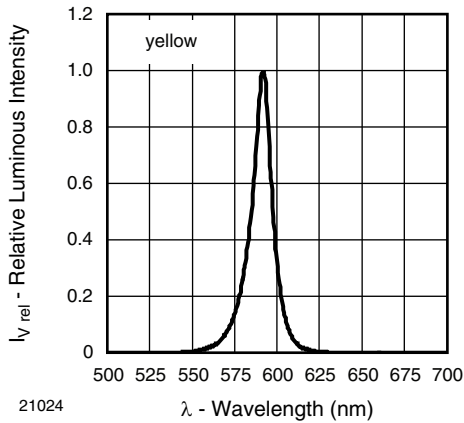

Fig. 13 - Relative Intensity vs. Wavelength

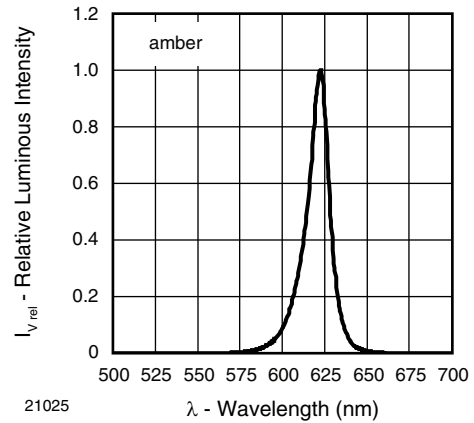
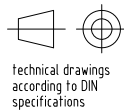
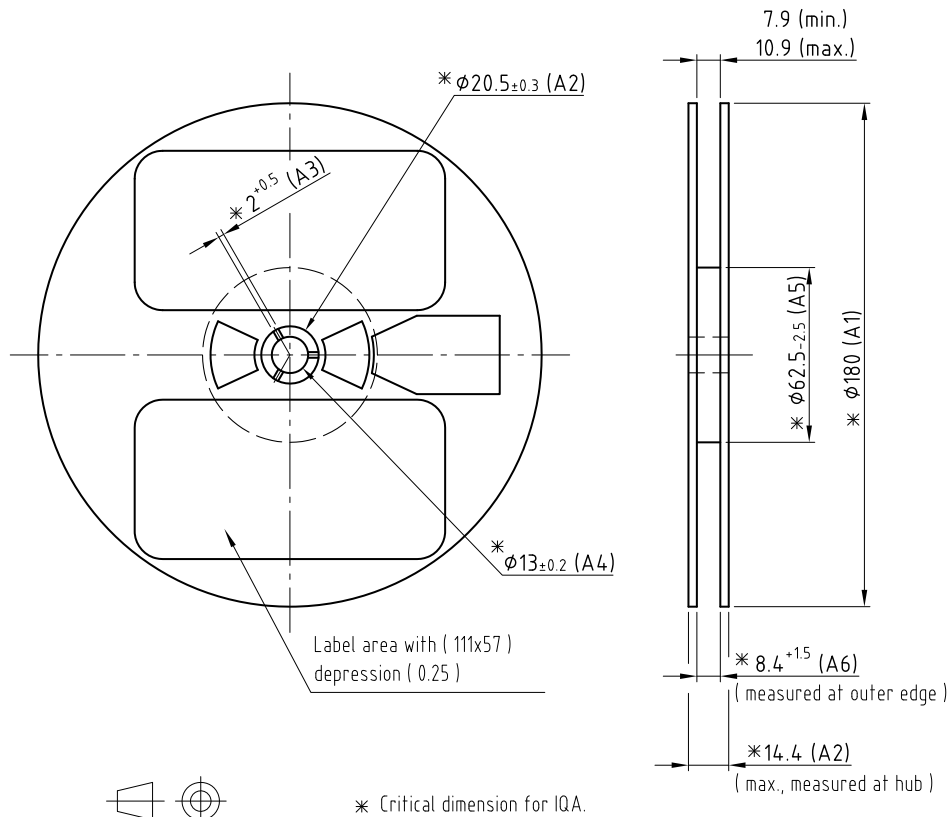

Fig. 14 - Relative Intensity vs. Wavelength

REEL DIMENSIONS in millimeters



Technical drawings according to DIN specifications

* Critical dimension for IQA.

GS08 = 2000 pcs

Not indicated tolerances ±0.05
Material: black static dissipative

Drawing refers to following types: φ180 mm Plastic reel

Drawing-No.: 9.800-5086.01-4
Issue: 2; 05.05.08

20983



TAPE DIMENSIONS in millimeters

Taping and orientation

180 reel come in quantity of 2000 units

330 reel come in quantity of 8000 units

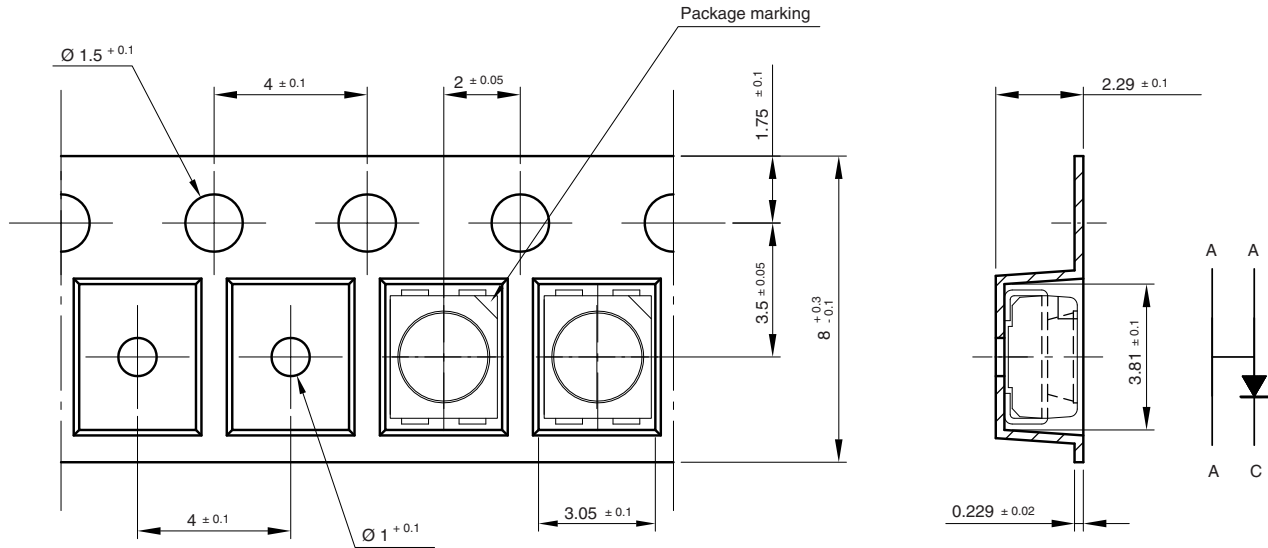

200 mm min. for 180 reel
200 mm min. for 330 reel

480 mm min. for 180 reel
960 mm min. for 330 reel

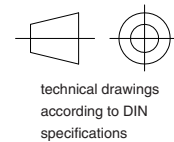
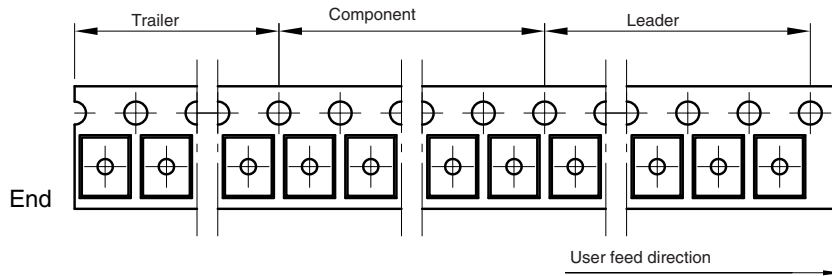

Drawing-No.: 9.700-5334.01-4

Issue: 3; 27.11.08

21066



PACKAGE/SOLDERING PADS DIMENSIONS in millimeters

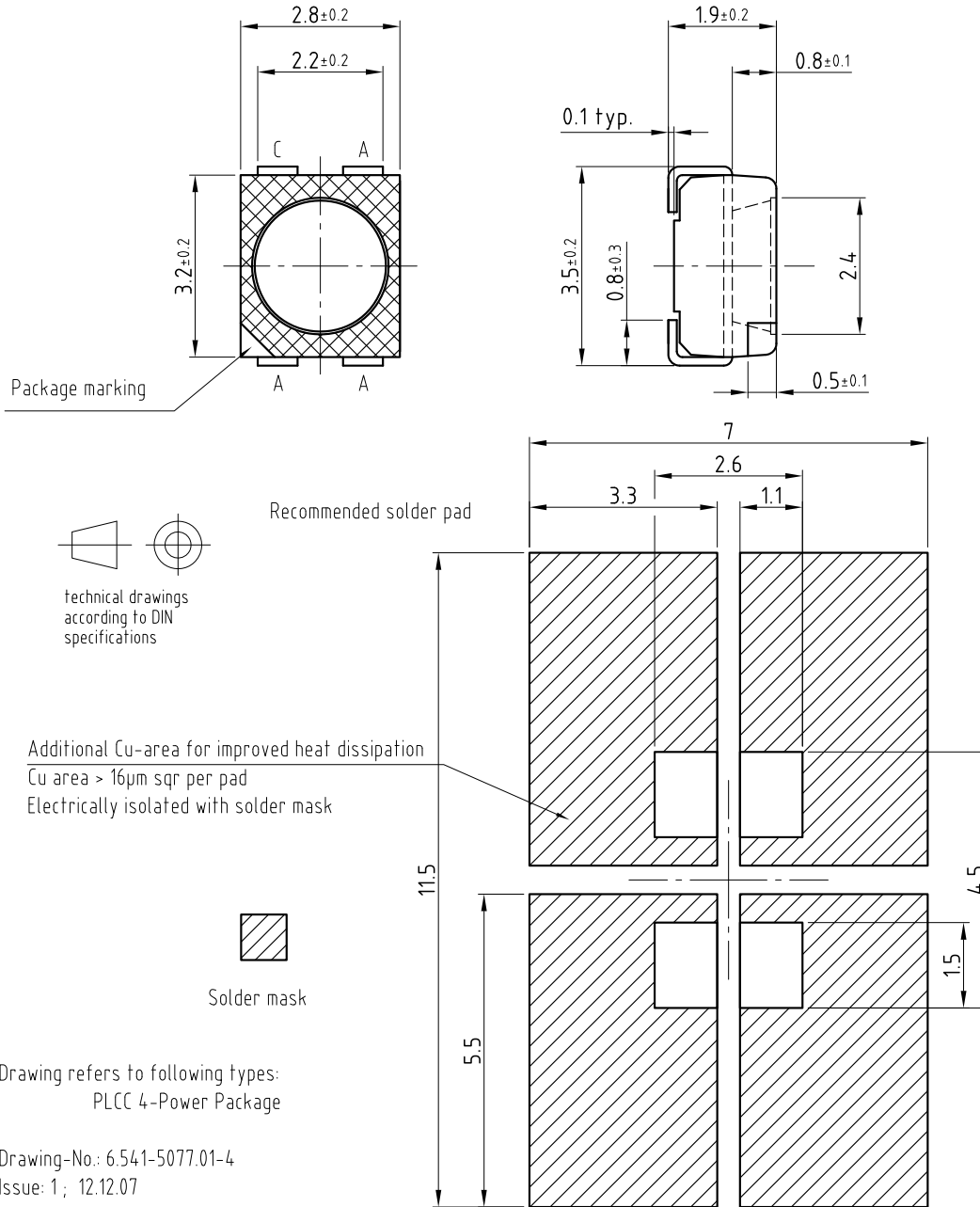

SOLDERING PROFILE

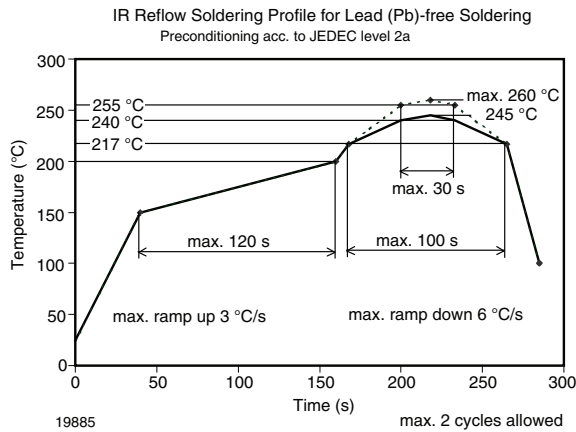

Fig. 15 - Vishay Lead (Pb)-free Reflow Soldering Profile (according to J-STD-020B)

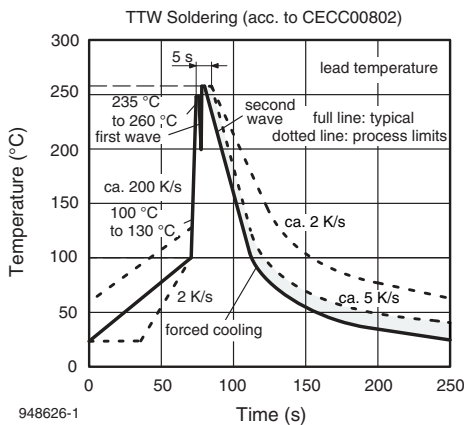
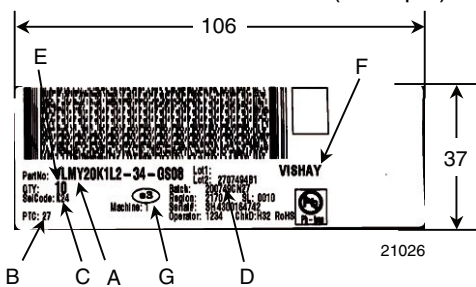

Fig. 16 - Double Wave Soldering of Opto Devices (all Packages)

BAR CODE PRODUCT LABEL (example)



- A. Type of component
- B. PTC = manufacturing plant
- C. SEL - selection code (bin)
e.g.:K2= code for luminous intensity group
4= code for color group
- D. Batch/date code
- E. Total quantity
- F. Company code
- G. Code for lead (Pb)-free classification (e3)

DRY PACKING

The reel is packed in an anti-humidity bag to protect the devices from absorbing moisture during transportation and storage.

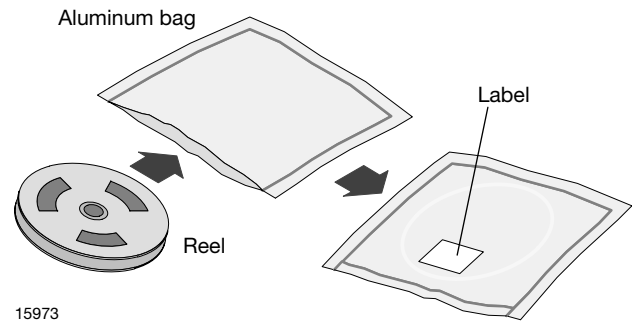

15973

FINAL PACKING

The sealed reel is packed into a cardboard box. A secondary cardboard box is used for shipping purposes.

RECOMMENDED METHOD OF STORAGE

Dry box storage is recommended as soon as the aluminum bag has been opened to prevent moisture absorption. The following conditions should be observed, if dry boxes are not available:

- Storage temperature 10 °C to 30 °C
- Storage humidity ≤ 60 % RH max.

After more than 672 h under these conditions moisture content will be too high for reflow soldering.

In case of moisture absorption, the devices will recover to the former condition by drying under the following condition:

- 192 h at 40 °C + 5 °C/- 0 °C and < 5 % RH (dry air/nitrogen) or
- 96 h at 60 °C + 5 °C and < 5 % RH for all device containers or
- 24 h at 100 °C + 5 °C not suitable for reel or tubes.

An EIA JEDEC standard JESD22-A112 level 2a label is included on all dry bags.

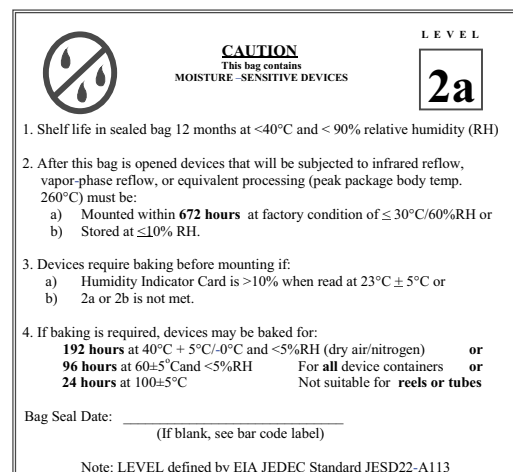

Example of JESD22-A112 level 2a label



ESD PRECAUTION

Proper storage and handling procedures should be followed to prevent ESD damage to the devices especially when they are removed from the antistatic shielding bag. Electro-static sensitive devices warning labels are on the packaging.

**VISHAY SEMICONDUCTORS STANDARD
BAR CODE LABEL**

The Vishay Semiconductors standard bar code labels are printed at final packing areas. The labels are on each packing unit and contain Vishay Semiconductors specific data.



Disclaimer

ALL PRODUCT, PRODUCT SPECIFICATIONS AND DATA ARE SUBJECT TO CHANGE WITHOUT NOTICE TO IMPROVE RELIABILITY, FUNCTION OR DESIGN OR OTHERWISE.

Vishay Intertechnology, Inc., its affiliates, agents, and employees, and all persons acting on its or their behalf (collectively, "Vishay"), disclaim any and all liability for any errors, inaccuracies or incompleteness contained in any datasheet or in any other disclosure relating to any product.

Vishay makes no warranty, representation or guarantee regarding the suitability of the products for any particular purpose or the continuing production of any product. To the maximum extent permitted by applicable law, Vishay disclaims (i) any and all liability arising out of the application or use of any product, (ii) any and all liability, including without limitation special, consequential or incidental damages, and (iii) any and all implied warranties, including warranties of fitness for particular purpose, non-infringement and merchantability.

Statements regarding the suitability of products for certain types of applications are based on Vishay's knowledge of typical requirements that are often placed on Vishay products in generic applications. Such statements are not binding statements about the suitability of products for a particular application. It is the customer's responsibility to validate that a particular product with the properties described in the product specification is suitable for use in a particular application. Parameters provided in datasheets and / or specifications may vary in different applications and performance may vary over time. All operating parameters, including typical parameters, must be validated for each customer application by the customer's technical experts. Product specifications do not expand or otherwise modify Vishay's terms and conditions of purchase, including but not limited to the warranty expressed therein.

Except as expressly indicated in writing, Vishay products are not designed for use in medical, life-saving, or life-sustaining applications or for any other application in which the failure of the Vishay product could result in personal injury or death. Customers using or selling Vishay products not expressly indicated for use in such applications do so at their own risk. Please contact authorized Vishay personnel to obtain written terms and conditions regarding products designed for such applications.

No license, express or implied, by estoppel or otherwise, to any intellectual property rights is granted by this document or by any conduct of Vishay. Product names and markings noted herein may be trademarks of their respective owners.