



N-Channel Enhancement-Mode Vertical DMOS Power FETs

Ordering Information

BV _{DSS} / BV _{DGS}	R _{DS(ON)} (max)	I _{D(OH)} (min)	Order Number / Package			
			TO-3	TO-39	TO-220	Dice
60V	0.7Ω	8.0A	VN1106N1	VN1106N2	VN1106N5	VN1106ND
100V	0.7Ω	8.0A	VN1110N1	VN1110N2	VN1110N5	VN1110ND

Features

- Freedom from secondary breakdown
- Low power drive requirement
- Ease of paralleling
- Low C_{ISS} and fast switching speeds
- Excellent thermal stability
- Integral Source-Drain diode
- High input impedance and high gain
- Complementary N- and P-Channel devices

Advanced DMOS Technology

These enhancement-mode (normally-off) power transistors utilize a vertical DMOS structure and Supertex's well-proven silicon-gate manufacturing process. This combination produces devices with the power handling capabilities of bipolar transistors and with the high input impedance and negative temperature coefficient inherent in MOS devices. Characteristic of all MOS structures, these devices are free from thermal runaway and thermally-induced secondary breakdown.

Supertex Vertical DMOS Power FETs are ideally suited to a wide range of switching and amplifying applications where high breakdown voltage, high input impedance, low input capacitance, and fast switching speeds are desired.

Applications

- Motor control
- Converters
- Amplifiers
- Switches
- Power supply circuits
- Drivers (Relays, Hammers, Solenoids, Lamps, Memories, Displays, Bipolar Transistors, etc.)

Package Options

(Note 1)

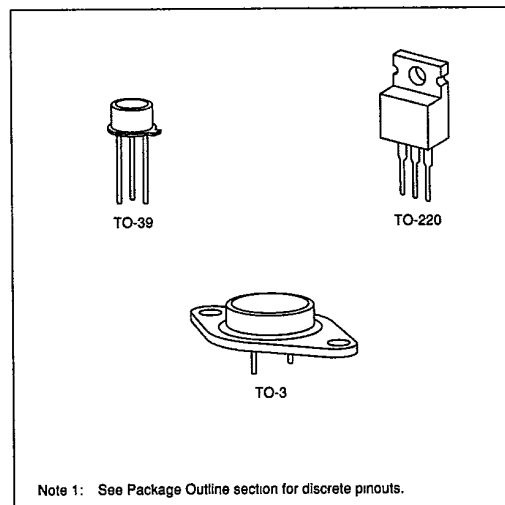

Note 1: See Package Outline section for discrete pinouts.

Absolute Maximum Ratings

Drain-to-Source Voltage	BV _{DSS}
Drain-to-Gate Voltage	BV _{DGS}
Gate-to-Source Voltage	± 20V
Operating and Storage Temperature	-55°C to +150°C
Soldering Temperature*	300°C

*Distance of 1.6 mm from case for 10 seconds.

Thermal Characteristics

T-39-11

Package	I _D (continuous)*	I _D (pulsed)*	Power Dissipation @ T _C = 25°C	θ _{JA} °C/W	θ _{JC} °C/W	I _{DR}	I _{DRM} *
TO - 3	9.0A	20A	75W	41	1.6	9A	20A
TO - 39	2.5A	6A	6W	125	20.8	2.5A	6A
TO - 220	7.0A	18A	45W	70	2.7	7A	18A

*I_D (continuous) is limited by max rated T_J.

Electrical Characteristics (@ 25°C unless otherwise specified)

(Notes 1 and 2)

Symbol	Parameter	Min	Typ	Max	Unit	Conditions
BVDS	Drain-to-Source Breakdown Voltage	VN1110	100			VGS = 0, ID = 5mA
		VN1106	60			
VGS(th)	Gate Threshold Voltage	0.8		2.4	V	VGS = VDS, ID = 5mA
ΔVGS(th)	Change in VGS(th) with Temperature		-4	-6	mV/°C	VGS = VDS, ID = 5mA
IGSS	Gate Body Leakage			100	nA	VGS = ±20V, VDS = 0
IDSS	Zero Gate Voltage Drain Current			50	μA	VGS = 0, VDS = Max Rating
				1	mA	VGS = 0, VDS = 0.8 Max Rating TA = 125°C
ID(ON)	ON-State Drain Current	3	5		A	VGS = 5V, VDS = 25V
		8	15			VGS = 10V, VDS = 25V
RDS(ON)	Static Drain-to-Source ON-State Resistance		0.7	1.0	Ω	VGS = 5V, ID = 3A
			0.4	0.7		VGS = 10V, ID = 5A
ΔRDS(ON)	Change in RDS(ON) with Temperature		0.3	0.8	%/°C	VGS = 10V, ID = 5A
GFS	Forward Transconductance	1	2		∅	VDS = 25V, ID = 3A
Ciss	Input Capacitance		240	350	pF	VGS = 0, VDS = 25V f = 1 MHz
Coss	Common Source Output Capacitance		150	200		
CRSS	Reverse Transfer Capacitance		16	25		
td(ON)	Turn-ON Delay Time		10	45	ns	VDD = 25V ID = 3A RS = 50Ω
tr	Rise Time		5	10		
td(OFF)	Turn-OFF Delay Time		35	45		
tf	Fall Time		20	35		
VSD	Diode Forward Voltage Drop		1.2	1.6		
trr	Reverse Recovery Time		300		ns	VGS = 0, ISD = 1A

Note 1: All D.C. parameters 100% tested at 25°C unless otherwise stated. (Pulse test: 300ms pulse, 2% duty cycle.)

Note 2: All A.C. parameters sample tested.

Switching Waveforms and Test Circuit

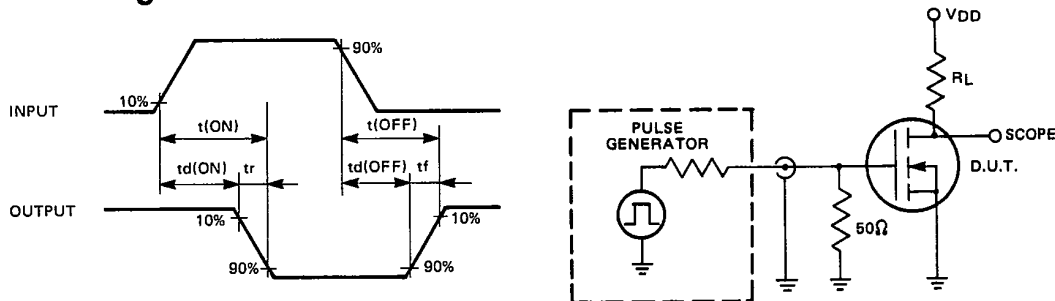

Typical Performance Curves

T-39-11

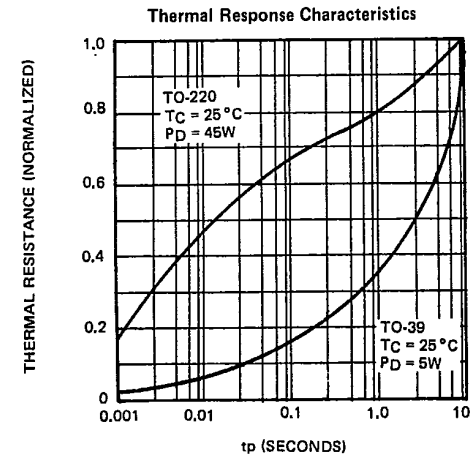
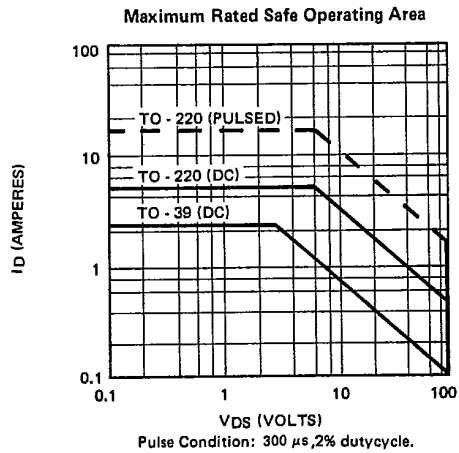
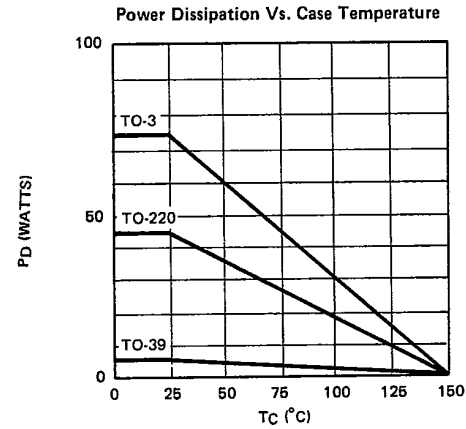
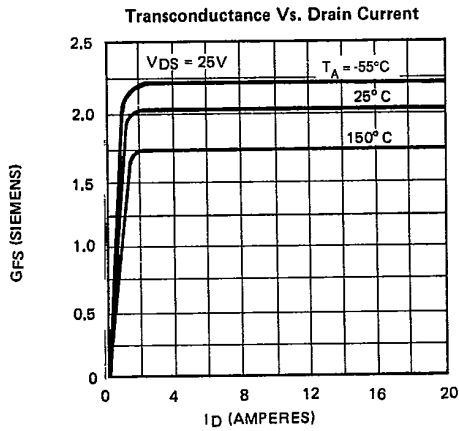
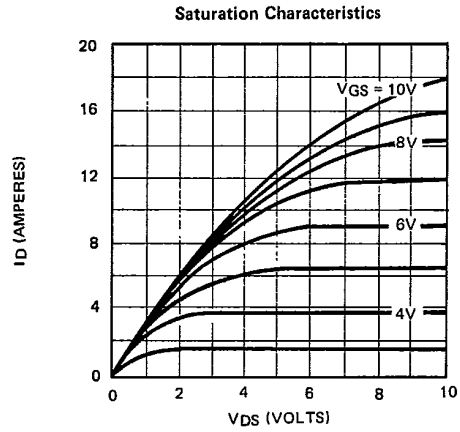
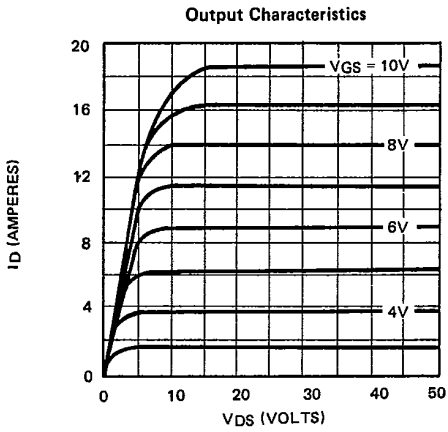

T-39-11

