

Power Phototriac

Pin	Function
2	LED anode
3	LED cathode
4	N/C
5	N/C
6	N/C
7	N/C
9, 13	Triac T2
11	Triac T1
15	Triac gate

21081

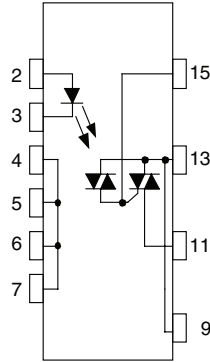

FEATURES

- Maximum trigger current (I_{FT}): 10 mA
- Isolation test voltage 5300 V_{RMS}
- Peak off-state voltage 600 V
- Load current 1 A
- dV/dt of 500 V/μs
- Pure tin leads

RoHS
COMPLIANT

APPLICATIONS

- Triac driver
- Programmable controllers
- AC-output module

AGENCY APPROVALS

- UL - E52744 system code H
- CUL - E52744 system code H
- VDE - DIN EN 60747-5-5 (VDE 0884)

DESCRIPTION

The VO3526 is an optically couple phototriac driving a power triac in a DIP-10 (16) package. It provides a 5300 V of input to output isolation.

ORDER INFORMATION

PART	REMARKS
VO3526	Tubes, DIP-10 (16)

Note

For additional information on the possible lead bend and VDE options refer to option information.

ABSOLUTE MAXIMUM RATINGS (1)

PARAMETER	TEST CONDITION	SYMBOL	VALUE	UNIT
INPUT				
LED continuous forward current		I_F	50	mA
LED reverse voltage		V_R	5.0	V
OUTPUT				
Repetitive peak off-state voltage	Sine wave, 50 to 60 Hz, gate open	V_{DRM}	600	V
On-state RMS current		$I_{T(RMS)}$	1.0	A
Peak nonrepetitive surge current (50 Hz, peak)		I_{TSM}	10	A
COUPLER				
Total power dissipation		P_{diss}	1.2	W
Ambient temperature range		T_{amb}	- 40 to + 85	°C
Storage temperature range		T_{stg}	- 40 to + 125	°C
Soldering temperature (2)	$t \leq 10$ s max.	T_{sld}	260	°C
Isolation test voltage	for 1.0 s	V_{ISO}	5300	V _{RMS}

Notes

(1) $T_{amb} = 25$ °C, unless otherwise specified.

Stresses in excess of the absolute maximum ratings can cause permanent damage to the device. Functional operation of the device is not implied at these or any other conditions in excess of those given in the operational sections of this document. Exposure to absolute maximum ratings for extended periods of the time can adversely affect reliability.

(2) Refer to wave profile for soldering conditions for through hole devices.

(3) Total power dissipation value is based on 2S2P PCB. Refer to power phototriac application note for PCB design tips.

ABSOLUTE MAXIMUM RATING CURVES

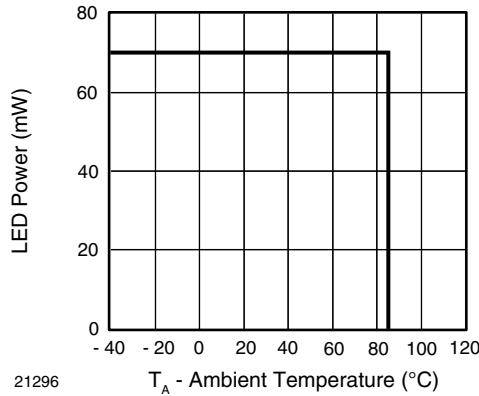

Fig. 1 - Power Dissipation vs. Temperature

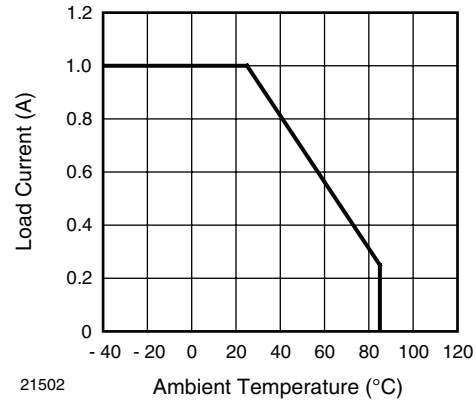

Fig. 2 - Allowable Load Current vs. Ambient Temperature

Note

The allowable load current was calculated out under a given operating conditions and only for reference:
 LED power: $Q_E = 0.015 \text{ W}$, $\theta_{BA} \text{ (4-layer)} = 30 \text{ }^\circ\text{C/W}$

THERMAL CHARACTERISTICS			
PARAMETER	SYMBOL	VALUE	UNIT
Maximum LED junction temperature	$T_{jmax.}$	105	$^\circ\text{C}$
Maximum NOT junction temperature	$T_{jmax.}$	105	$^\circ\text{C}$
Thermal resistance, junction NOT to bord	θ_{NOT-B}	75	$^\circ\text{C/W}$
Thermal resistance, junction NOT to case	θ_{NOT-C}	150	$^\circ\text{C/W}$
Thermal resistance, junction OT to board	θ_{OT-B}	158	$^\circ\text{C/W}$
Thermal resistance, junction OT to case	θ_{OT-C}	157	$^\circ\text{C/W}$
Thermal resistance, junction emitter to board	θ_{E-B}	149	$^\circ\text{C/W}$
Thermal resistance, junction emitter to case	θ_{E-C}	161	$^\circ\text{C/W}$
Thermal resistance, junction NOT to junction OT	θ_{NOT-OT}	243	$^\circ\text{C/W}$
Thermal resistance, junction emitter to junction NOT	θ_{E-NOT}	420	$^\circ\text{C/W}$
Thermal resistance, junction emitter to junction OT	θ_{E-OT}	235	$^\circ\text{C/W}$
Thermal resistance, case to ambient	θ_{CA}	130	$^\circ\text{C/W}$

Note

The thermal model is represented in the thermal network below. Each resistance value given in this model can be used to calculate the temperatures at each node for a given operating condition. The thermal resistance from board to ambient will be dependent on the type of PCB, layout and thickness of copper traces. For a detailed explanation of the thermal model, please reference Vishay's Thermal Characteristics of Power Phototriac application note.

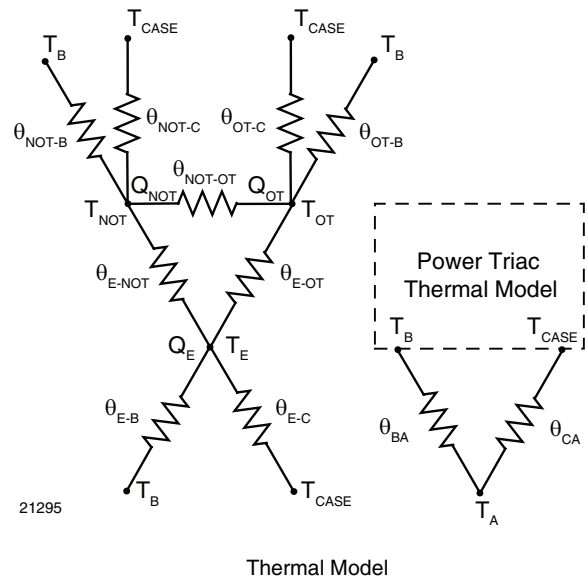

- NOT: Non-opto-triac
- OT: Opto-triac
- T_B : Board temperature
- T_{CASE} : Case temperature
- T_A : Ambient temperature
- θ_{BA} : Thermal resistance, board to ambient
- Q_E : LED power dissipation
- Q_{OT} : OT power dissipation
- Q_{NOT} : NOT power dissipation

ELECTRICAL CHARACTERISTICS						
PARAMETER	TEST CONDITION	SYMBOL	MIN.	TYP.	MAX.	UNIT
INPUT						
LED trigger current	$V_T = 6\text{ V}$	I_{FT}			10	mA
Input reverse current	$V_R = 5\text{ V}$	I_R			10	μA
LED forward voltage	$I_F = 10\text{ mA}$	V_F	0.9		1.4	V
OUTPUT						
Peak on-state voltage	$I_{TM} = 1.5\text{ A}$	V_{TM}			1.7	V
Repetitive peak off-state current	$V_{DRM} = 600\text{ V}$, $T_A = 110\text{ }^\circ\text{C}$, 60 Hz	I_{DRM}			100	μA
Holding current	$R_L = 100\ \Omega$	I_H			25	mA
Critical rate of rise of off-state voltage	$V_{IN} = 400\text{ V}$ (fig. 3)	dV/dt		210		V/ μs
Critical rate of rise of commutating voltage	$V_{IN} = 240\text{ V}_{RMS}$, $I_T = 1\text{ A}_{RMS}$ (fig. 3)	dV/dt (c)		0.9		V/ μs

Note

$T_{amb} = 25\text{ }^\circ\text{C}$, unless otherwise specified.

Minimum and maximum values are testing requirements. Typical values are characteristics of the device and are the result of engineering evaluations. Typical values are for information only and are not part of the testing requirements.

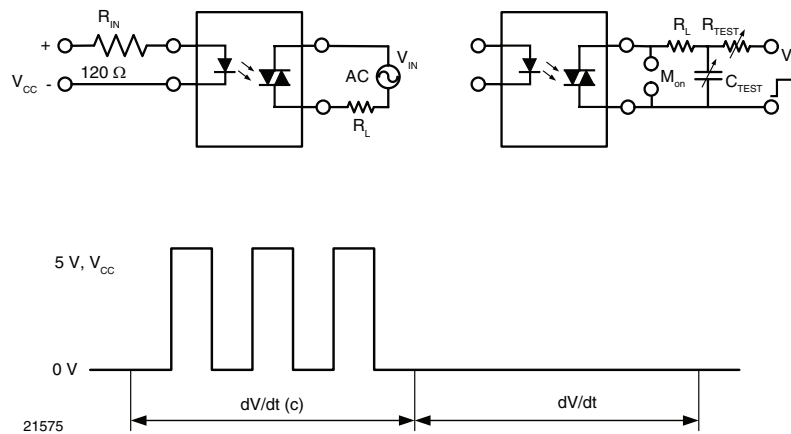

Fig. 3 - dV/dt Test Circuit

RECOMMENDED OPERATING CONDITIONS							
PARAMETER		TEST CONDITION	SYMBOL	MIN.	MAX.	UNIT	
Forward current at on-state	Input		$I_{F(ON)}$	10	20	mA	
Forward current at off-state			$I_{F(OFF)}$	0	0.1	mA	
Load supply voltage	Output	With snubber (0.022 μF , 47 Ω)	$V_{OUT(RMS)}$		240	V	
On-state RMS current		$T_A = 40\text{ }^\circ\text{C}$	On 4-layer PCB ($R_{BA} = 30\text{ }^\circ\text{C/W}$)	$I_{OUT(RMS)}$		0.8	A
		$T_A = 60\text{ }^\circ\text{C}$				0.6	A
Frequency			f	50	60	Hz	
Operating temperature				- 40	85	$^\circ\text{C}$	

SAFETY AND INSULATION RATINGS						
PARAMETER	TEST CONDITION	SYMBOL	MIN.	TYP.	MAX.	UNIT
Climatic classification	IEC 68 part 1			40/85/21		
Pollution degree	DIN VDE 0109			2		
Tracking resistance (comparative tracking index)	Insulation group IIIa	CTI	175			
Highest allowable overvoltage	Transient overvoltage	V_{IOTM}	8000			V_{peak}
Maximum working insulation voltage	Recurring peak voltage	V_{IORM}	890			V_{peak}
Insulation resistance at 25 °C	$V_{IO} = 500\text{ V}$	R_{IS}			$\geq 10^{12}$	Ω
Insulation resistance at T_S	$V_{IO} = 500\text{ V}$	R_{IS}			$\geq 10^9$	Ω
Insulation resistance at 100 °C	$V_{IO} = 500\text{ V}$	R_{IS}			$\geq 10^{11}$	Ω
Partial discharge test voltage	Method b, $V_{pd} = V_{IORM} \times 1.6$	V_{pd}			1424	V_{peak}
Safety limiting values - maximum values allowed in the event of a failure	Output power	P_{SO}			2	W
	Input current	I_{SI}			150	mA
	Case temperature	T_{SI}			165	°C
Minimum external air gap (clearance)	Measured from input terminals to output terminals, shortest distance through air		≥ 7			mm
Minimum external tracking (creepage)	Measured from input terminals to output terminals, shortest distance path along body		≥ 7			mm

Note

This phototriac coupler is suitable for 'safe electrical insulation' only within the safety ratings. Compliance with safety ratings shall be ensured by means of protective circuits.

TYPICAL CHARACTERISTICS

$T_{amb} = 25\text{ °C}$, unless otherwise specified

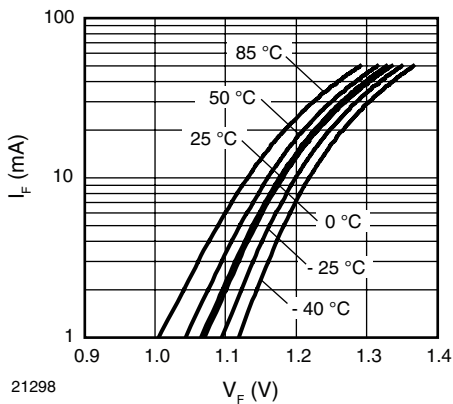

Fig. 4 - Forward Current vs. Forward Voltage

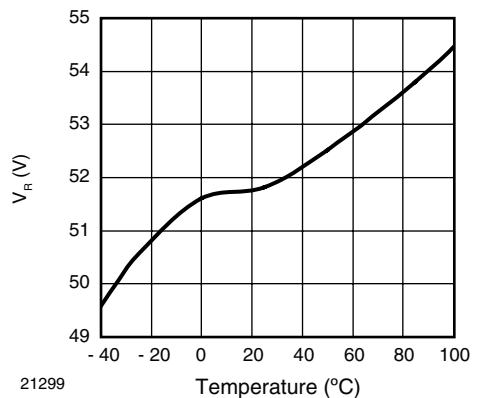

Fig. 5 - Diode Reverse Voltage vs. Temperature

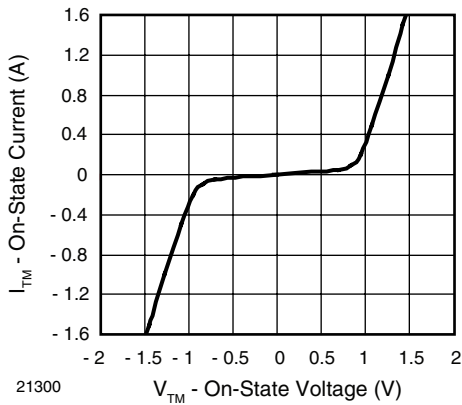

Fig. 6 - On-State Current vs. On State Voltage

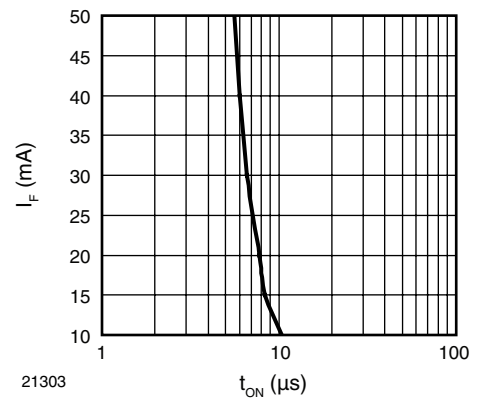

Fig. 9 - Trigger Input Current vs. Turn-on Time

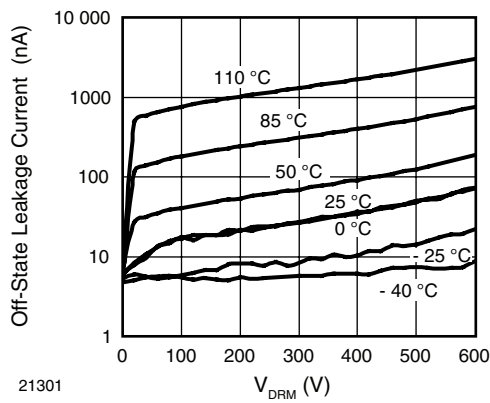

Fig. 7 - Off-State Leakage Current vs. Voltage

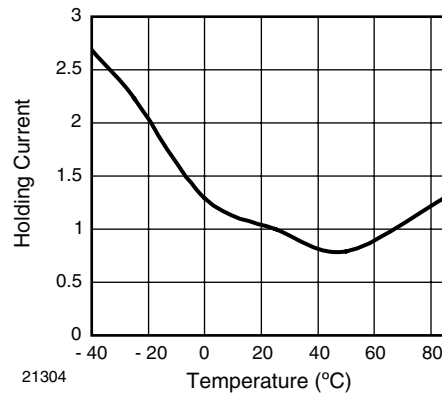

Fig. 10 - Normalized Holding Current vs. Temperature

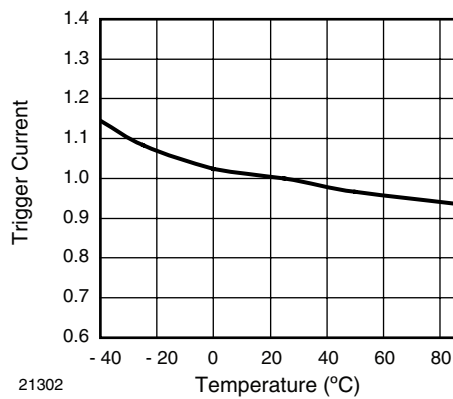

Fig. 8 - Normalized Trigger Input Current vs. Temperature

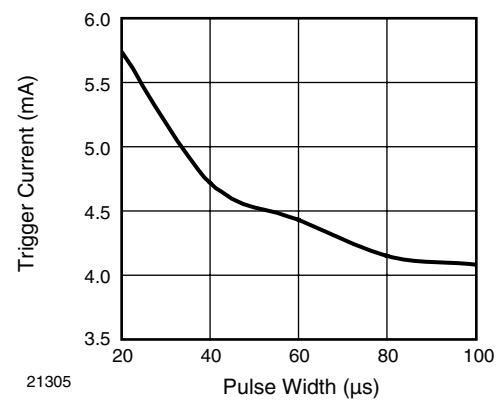

Fig. 11 - Trigger Current vs. Trigger Pulse Width

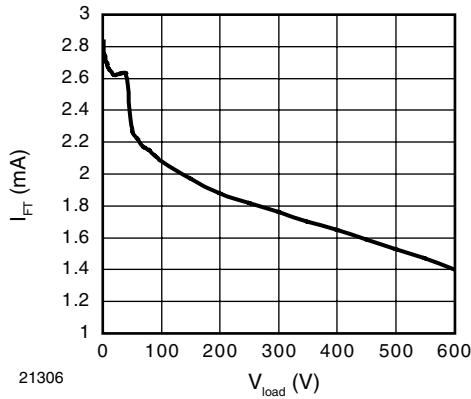
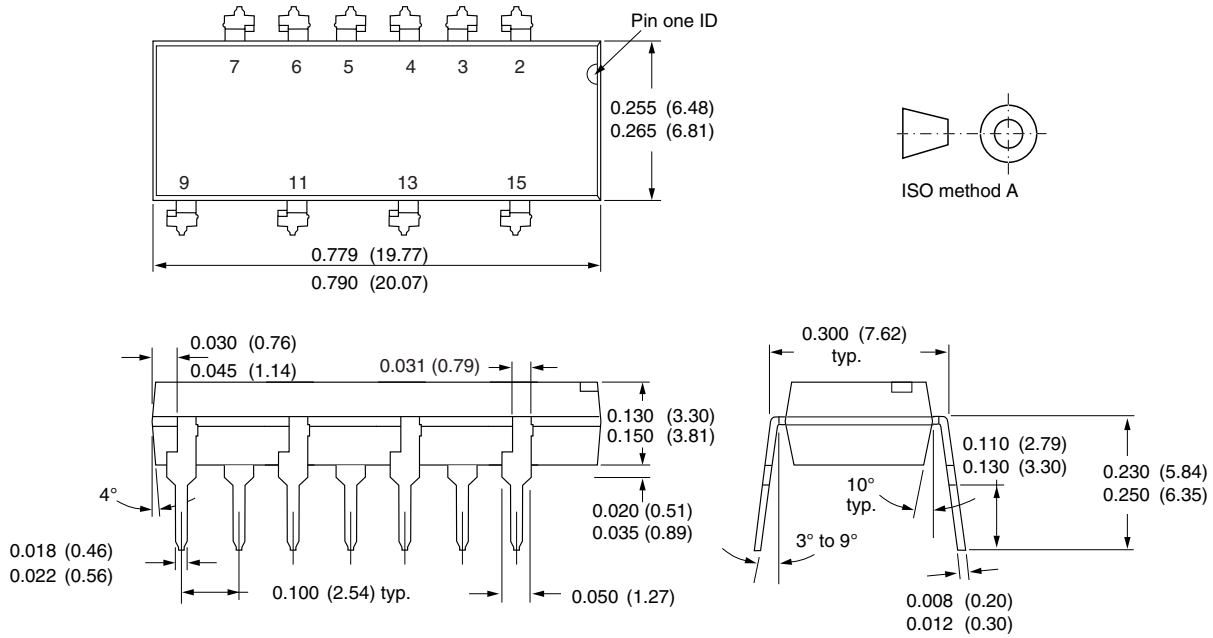

Fig. 12 - Trigger Current vs. V_{load}

PACKAGE DIMENSIONS in inches (millimeters)



21083

**OZONE DEPLETING SUBSTANCES POLICY STATEMENT**

It is the policy of Vishay Semiconductor GmbH to

1. Meet all present and future national and international statutory requirements.
2. Regularly and continuously improve the performance of our products, processes, distribution and operating systems with respect to their impact on the health and safety of our employees and the public, as well as their impact on the environment.

It is particular concern to control or eliminate releases of those substances into the atmosphere which are known as ozone depleting substances (ODSs).

The Montreal Protocol (1987) and its London Amendments (1990) intend to severely restrict the use of ODSs and forbid their use within the next ten years. Various national and international initiatives are pressing for an earlier ban on these substances.

Vishay Semiconductor GmbH has been able to use its policy of continuous improvements to eliminate the use of ODSs listed in the following documents.

1. Annex A, B and list of transitional substances of the Montreal Protocol and the London Amendments respectively.
2. Class I and II ozone depleting substances in the Clean Air Act Amendments of 1990 by the Environmental Protection Agency (EPA) in the USA.
3. Council Decision 88/540/EEC and 91/690/EEC Annex A, B and C (transitional substances) respectively.

Vishay Semiconductor GmbH can certify that our semiconductors are not manufactured with ozone depleting substances and do not contain such substances.

We reserve the right to make changes to improve technical design
and may do so without further notice.

Parameters can vary in different applications. All operating parameters must be validated for each customer application by the customer. Should the buyer use Vishay Semiconductors products for any unintended or unauthorized application, the buyer shall indemnify Vishay Semiconductors against all claims, costs, damages, and expenses, arising out of, directly or indirectly, any claim of personal damage, injury or death associated with such unintended or unauthorized use.

Vishay Semiconductor GmbH, P.O.B. 3535, D-74025 Heilbronn, Germany



Disclaimer

All product specifications and data are subject to change without notice.

Vishay Intertechnology, Inc., its affiliates, agents, and employees, and all persons acting on its or their behalf (collectively, "Vishay"), disclaim any and all liability for any errors, inaccuracies or incompleteness contained herein or in any other disclosure relating to any product.

Vishay disclaims any and all liability arising out of the use or application of any product described herein or of any information provided herein to the maximum extent permitted by law. The product specifications do not expand or otherwise modify Vishay's terms and conditions of purchase, including but not limited to the warranty expressed therein, which apply to these products.

No license, express or implied, by estoppel or otherwise, to any intellectual property rights is granted by this document or by any conduct of Vishay.

The products shown herein are not designed for use in medical, life-saving, or life-sustaining applications unless otherwise expressly indicated. Customers using or selling Vishay products not expressly indicated for use in such applications do so entirely at their own risk and agree to fully indemnify Vishay for any damages arising or resulting from such use or sale. Please contact authorized Vishay personnel to obtain written terms and conditions regarding products designed for such applications.

Product names and markings noted herein may be trademarks of their respective owners.