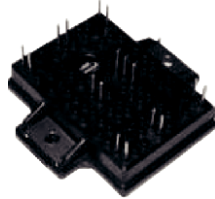

Dual Mode PFC, 60 A

EMIPAK2
FEATURES

- NPT Warp2 PFC IGBT with low $V_{CE(ON)}$
- Silicon carbide PFC diode
- Antiparallel FRED Pt® fast recovery
- Integrated thermistor
- Square RBSOA
- Operating frequency 60 kHz to 150 kHz
- Low internal inductances
- Low switching loss
- UL approved file E78996
- Material categorization: For definitions of compliance please see www.vishay.com/doc?99912

RoHS
COMPLIANT

PRODUCT SUMMARY	
V_{CES}	600 V
$V_{CE(ON)}$ typical at $I_C = 50$ A	1.8 V
I_C at $T_C = 98$ °C	50 A
Package	EMIPAK2
Circuit	Dual Mode PFC

DESCRIPTION

VS-EMG050J60N is an integrated solution for dual stage PFC converter in a single package. The EMIPAK2 package is easy to use thanks to the solderable terminals and provides improved thermal performance thanks to the exposed substrate. The optimized layout also helps to minimize stray parameters, allowing for better EMI performance.

ABSOLUTE MAXIMUM RATINGS				
PARAMETER	SYMBOL	TEST CONDITIONS	MAX.	UNITS
Maximum operating junction temperature	T_J		150	°C
Storage temperature range	T_{Stg}		- 40 to 125	
RMS isolation voltage	V_{ISOL}	$T_J = 25$ °C, all terminals shorted, $f = 50$ Hz, $t = 1$ s	3500	V
PFC IGBT Q1 - Q2				
Collector to emitter voltage	V_{CES}		600	V
Gate to emitter voltage	V_{GES}		20	
Pulsed collector current	I_{CM}		150	A
Clamped inductive load current	$I_{LM}^{(1)}$		150	
Continuous collector current	I_C	$T_C = 25$ °C	88	
		$T_C = 80$ °C	60	
Power dissipation	P_D	$T_C = 25$ °C	338	W
		$T_C = 80$ °C	189	
ANTIPARALLEL DIODE D1 - D2				
Diode continuous forward current	I_F	$T_C = 25$ °C	16	A
		$T_C = 80$ °C	11	
Single pulse forward current	I_{FSM}	10 ms sine or 6 ms rectangular pulse, $T_J = 25$ °C	59	
Power dissipation	P_D	$T_C = 25$ °C	29	W
		$T_C = 80$ °C	16	
PFC DIODE D3 - D4				
Repetitive peak reverse voltage	V_{RRM}		600	V
Diode continuous forward current	I_F	$T_C = 25$ °C	25	A
		$T_C = 80$ °C	17	
Single pulse forward current	I_{FSM}	10 ms sine or 6 ms rectangular pulse, $T_J = 25$ °C	140	
Power dissipation	P_D	$T_C = 25$ °C	74	W
		$T_C = 80$ °C	41	

Notes

- Absolute Maximum Ratings indicate sustained limits beyond which damage to the device may occur.

⁽¹⁾ $V_{CC} = 400$ V, $V_{GE} = 15$ V, $L = 500$ μ H, $R_g = 22$ Ω , $T_J = 150$ °C



ELECTRICAL SPECIFICATIONS ($T_J = 25\text{ }^\circ\text{C}$ unless otherwise noted)						
PARAMETER	SYMBOL	TEST CONDITIONS	MIN.	TYP.	MAX.	UNITS
PFC IGBT Q1 - Q2						
Collector to emitter breakdown voltage	BV_{CES}	$V_{GE} = 0\text{ V}, I_C = 500\text{ }\mu\text{A}$	600	-	-	V
Temperature coefficient of breakdown voltage	$\Delta BV_{CES}/\Delta T_J$	$V_{GE} = 0\text{ V}, I_C = 500\text{ }\mu\text{A}$ ($25\text{ }^\circ\text{C}$ to $125\text{ }^\circ\text{C}$)	-	0.1	-	V/ $^\circ\text{C}$
Collector to emitter voltage	$V_{CE(ON)}$	$V_{GE} = 15\text{ V}, I_C = 27\text{ A}$	-	1.44	1.75	V
		$V_{GE} = 15\text{ V}, I_C = 50\text{ A}$	-	1.8	2.1	
		$V_{GE} = 15\text{ V}, I_C = 27\text{ A}, T_J = 125\text{ }^\circ\text{C}$	-	1.7	2.05	
		$V_{GE} = 15\text{ V}, I_C = 50\text{ A}, T_J = 125\text{ }^\circ\text{C}$	-	2.2	2.5	
Gate threshold voltage	$V_{GE(th)}$	$V_{CE} = V_{GE}, I_C = 250\text{ }\mu\text{A}$	2.9	3.9	5.3	
Temperature coefficient of threshold voltage	$\Delta V_{GE(th)}/\Delta T_J$	$V_{CE} = V_{GE}, I_C = 1\text{ mA}$ ($25\text{ }^\circ\text{C}$ to $125\text{ }^\circ\text{C}$)	-	- 10	-	mV/ $^\circ\text{C}$
Forward transconductance	g_{fe}	$V_{CE} = 20\text{ V}, I_C = 50\text{ A}$	-	95	-	s
Transfer characteristics	V_{GE}	$V_{CE} = 20\text{ V}, I_C = 50\text{ A}$	-	5.9	-	V
Zero gate voltage collector current	I_{CES}	$V_{GE} = 0\text{ V}, V_{CE} = 600\text{ V}$	-	3	100	μA
		$V_{GE} = 0\text{ V}, V_{CE} = 600\text{ V}, T_J = 125\text{ }^\circ\text{C}$	-	0.170	3	mA
Gate to emitter leakage current	I_{GES}	$V_{GE} = \pm 20\text{ V}, V_{CE} = 0\text{ V}$	-		± 200	nA
ANTIPARALLEL DIODE D1 - D2						
Forward voltage drop	V_F	$I_F = 20\text{ A}$	-	2.19	2.4	V
		$I_F = 20\text{ A}, T_J = 125\text{ }^\circ\text{C}$	-	1.93	2.15	
PFC DIODE D3 - D4						
Cathode to anode breakdown voltage	V_{BR}	$I_R = 500\text{ }\mu\text{A}$	600	-	-	V
Reverse leakage current	I_{RM}	$V_R = 600\text{ V}$	-	27	250	μA
		$V_R = 600\text{ V}, T_J = 125\text{ }^\circ\text{C}$	-	0.1	1	mA
Forward voltage drop	V_F	$I_F = 10\text{ A}$	-	1.34	1.63	V
		$I_F = 10\text{ A}, T_J = 125\text{ }^\circ\text{C}$	-	1.36	1.65	

SWITCHING CHARACTERISTICS ($T_J = 25\text{ }^\circ\text{C}$ unless otherwise noted)						
PARAMETER	SYMBOL	TEST CONDITIONS	MIN.	TYP.	MAX.	UNITS
PFC IGBT Q1 - Q2 (WITH FREEWHEELING D3 - D4 PFC DIODE)						
Total gate charge (turn-on)	Q_g	$I_C = 70\text{ A}$ $V_{CC} = 400\text{ V}$ $V_{GE} = 15\text{ V}$	-	480	720	nC
Gate to emitter charge (turn-on)	Q_{ge}		-	82	164	
Gate to collector charge (turn-on)	Q_{gc}		-	160	260	
Turn-on switching loss	E_{ON}	$I_C = 50\text{ A}$ $V_{CC} = 400\text{ V}$ $V_{GE} = 15\text{ V}$ $R_g = 4.7\text{ }\Omega$ $L = 500\text{ }\mu\text{H}$ $T_J = 25\text{ }^\circ\text{C}^{(1)}$	-	0.155	-	mJ
Turn-off switching loss	E_{OFF}		-	0.471	-	
Total switching loss	E_{TOT}		-	0.626	-	
Turn-on delay time	$t_{d(on)}$			-	196	-
Rise time	t_r	-		29	-	
Turn-off delay time	$t_{d(off)}$	-		220	-	
Fall time	t_f	-		67	-	



SWITCHING CHARACTERISTICS ($T_J = 25\text{ }^\circ\text{C}$ unless otherwise noted)						
PARAMETER	SYMBOL	TEST CONDITIONS	MIN.	TYP.	MAX.	UNITS
Turn-on switching loss	E_{ON}	$I_C = 50\text{ A}$ $V_{CC} = 400\text{ V}$ $V_{GE} = 15\text{ V}$	-	0.182	-	mJ
Turn-off switching loss	E_{OFF}		-	0.615	-	
Total switching loss	E_{TOT}		-	0.797	-	
Turn-on delay time	$t_{d(on)}$	$R_g = 4.7\text{ }\Omega$ $L = 500\text{ }\mu\text{H}$ $T_J = 125\text{ }^\circ\text{C}^{(1)}$	-	198	-	ns
Rise time	t_r		-	29	-	
Turn-off delay time	$t_{d(off)}$		-	227	-	
Fall time	t_f		-	75	-	
Input capacitance	C_{ies}	$V_{GE} = 0\text{ V}$ $V_{CC} = 30\text{ V}$ $f = 1\text{ MHz}$	-	9500	-	pF
Output capacitance	C_{oes}		-	780	-	
Reverse transfer capacitance	C_{res}		-	116	-	
Reverse bias safe operating area	RBSOA	$T_J = 150\text{ }^\circ\text{C}$, $I_C = 150\text{ A}$ $V_{CC} = 400\text{ V}$, $V_P = 600\text{ V}$ $R_g = 22\text{ }\Omega$, $V_{GE} = 15\text{ V to } 0\text{ V}$	Fullsquare			

ANTIPARALLEL DIODE D1 - D2						
Diode reverse recovery time	t_{rr}	$V_R = 200\text{ V}$ $I_F = 20\text{ A}$ $di/dt = 500\text{ A}/\mu\text{s}$, $T_J = 25\text{ }^\circ\text{C}$	-	65	110	ns
Diode peak reverse current	I_{rr}		-	11	15	A
Diode reverse charge	Q_{rr}		-	350	825	nC
Diode reverse recovery time	t_{rr}	$V_R = 200\text{ V}$ $I_F = 20\text{ A}$ $di/dt = 500\text{ A}/\mu\text{s}$, $T_J = 125\text{ }^\circ\text{C}$	-	83	130	ns
Diode peak reverse current	I_{rr}		-	15	20	A
Diode reverse charge	Q_{rr}		-	587	1300	nC

PFC DIODE D3 - D4						
Diode reverse recovery time	t_{rr}	$V_R = 200\text{ V}$ $I_F = 10\text{ A}$ $di/dt = 200\text{ A}/\mu\text{s}$, $T_J = 25\text{ }^\circ\text{C}$	-	43	-	ns
Diode peak reverse current	I_{rr}		-	2.13	-	A
Diode reverse charge	Q_{rr}		-	45.5	-	nC
Diode reverse recovery time	t_{rr}	$V_R = 200\text{ V}$ $I_F = 10\text{ A}$ $di/dt = 200\text{ A}/\mu\text{s}$, $T_J = 125\text{ }^\circ\text{C}$	-	44	-	ns
Diode peak reverse current	I_{rr}		-	2.14	-	A
Diode reverse charge	Q_{rr}		-	46.5	-	nC

Note

(1) Energy losses include “tail” and diode reverse recovery.

THERMISTOR ELECTRICAL CHARACTERISTICS ($T_J = 25\text{ }^\circ\text{C}$ unless otherwise noted)						
PARAMETER	SYMBOL	TEST CONDITIONS	MIN.	TYP.	MAX.	UNITS
Resistance	R_{25}		4500	5000	5500	Ω
	R_{100}	$T_J = 100\text{ }^\circ\text{C}$	468	493	518	
B value	B	$T_J = 25\text{ }^\circ\text{C}/T_J = 50\text{ }^\circ\text{C}$	3206	3375	3544	K



THERMAL AND MECHANICAL SPECIFICATIONS					
PARAMETER	SYMBOL	MIN.	TYP.	MAX.	UNITS
Q1 - Q2 PFC IGBT - Junction to case thermal resistance (per switch)	R_{thJC}	-	-	0.37	°C/W
D1 - D2 AP diode - Junction to case thermal resistance (per diode)		-	-	4.29	
D3 - D4 PFC diode - Junction to case thermal resistance (per diode)		-	-	1.69	
Q1 - Q2 PFC IGBT - Case to sink thermal resistance (per switch)	$R_{thCS}^{(1)}$	-	0.31	-	
D1 - D2 AP diode - Case to sink thermal resistance (per diode)		-	3.66	-	
D3 - D4 PFC diode - Case to sink thermal resistance (per diode)		-	1.1	-	
Mounting torque (M4)		2	-	3	Nm
Weight		-	39	-	g

Note

(1) Mounting surface flat, smooth, and greased

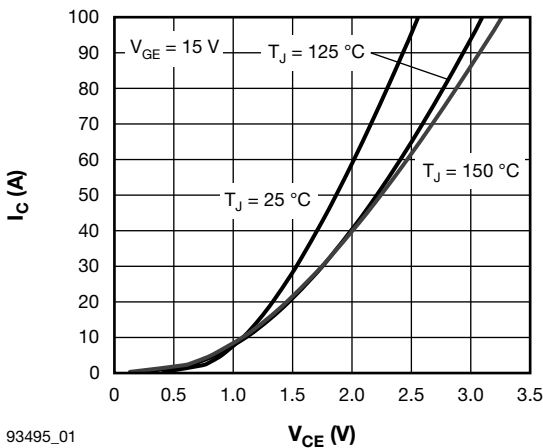

93495_01

Fig. 1 - Typical PFC IGBT Output Characteristics

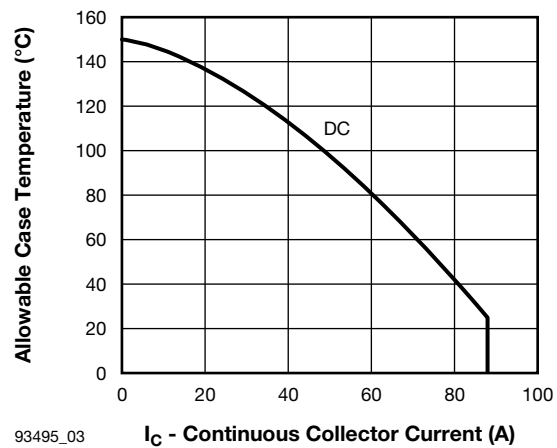

93495_03

I_c - Continuous Collector Current (A)

Fig. 3 - Maximum DC PFC IGBT Collector Current vs. Case Temperature per Junction

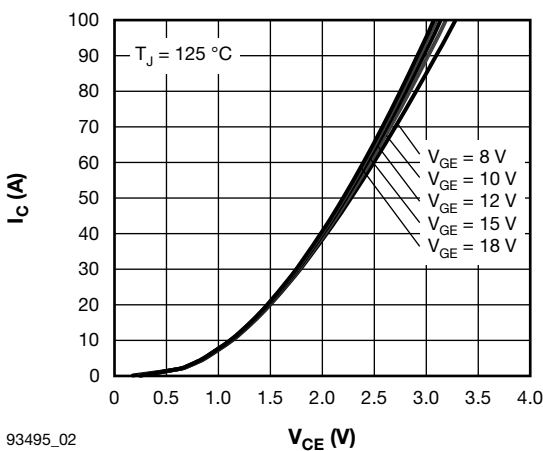

93495_02

Fig. 2 - Typical PFC IGBT Output Characteristics

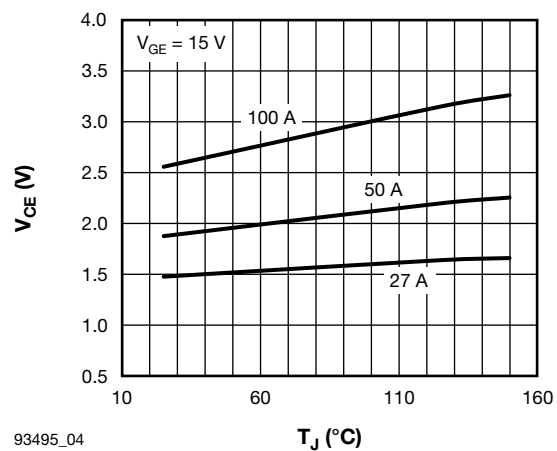

93495_04

Fig. 4 - Typical PFC IGBT Collector to Emitter Voltage vs. Junction Temperature

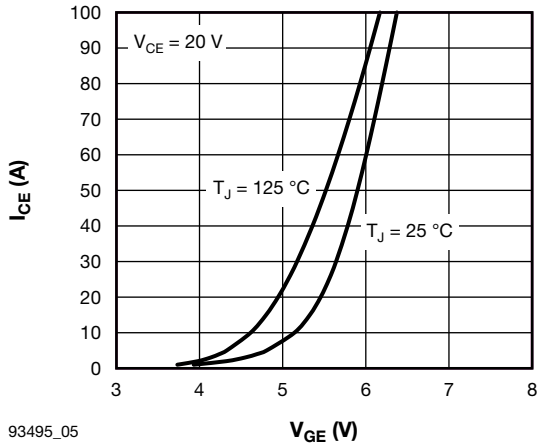

93495_05

Fig. 5 - Typical PFC IGBT Transfer Characteristics

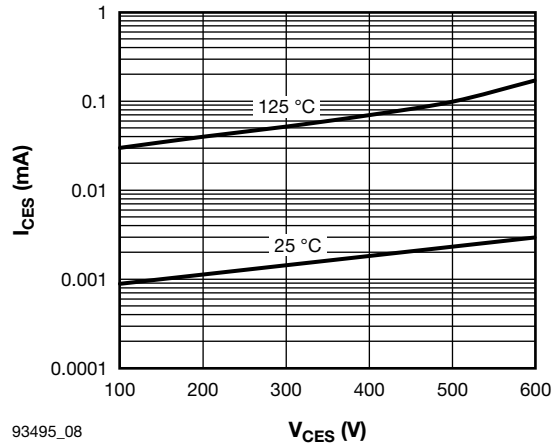

93495_08

Fig. 8 - Typical PFC IGBT Zero Gate Voltage Collector Current

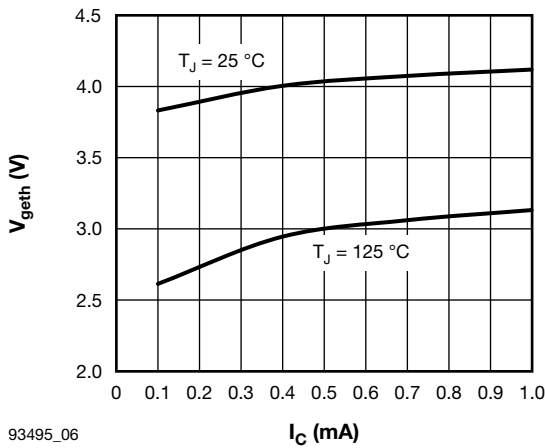

93495_06

Fig. 6 - Typical PFC IGBT Gate Threshold Voltage

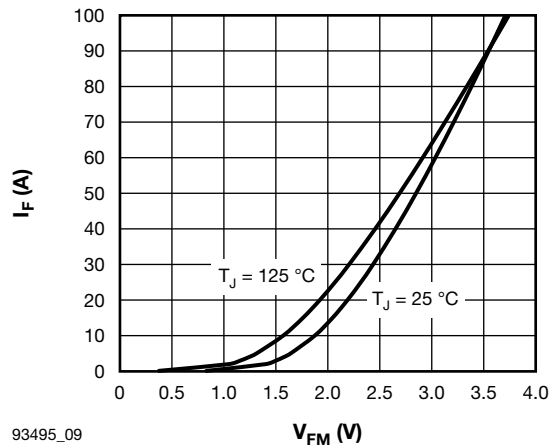

93495_09

Fig. 9 - Typical Antiparallel Diode Forward Characteristics

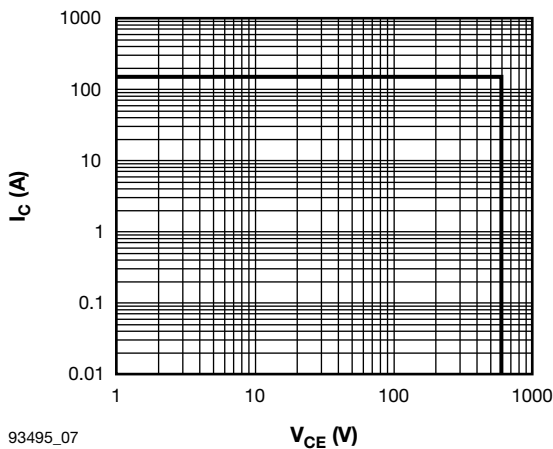

93495_07

Fig. 7 - IGBT Reverse Bias SOA
 $T_J = 150\text{ °C}$, $V_{GE} = 15\text{ V}$, $R_g = 22\ \Omega$

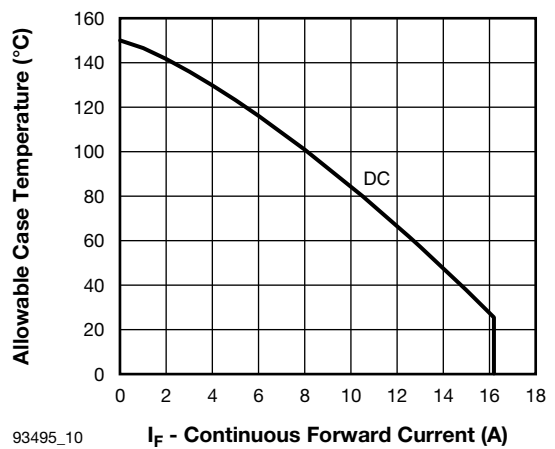

93495_10

Fig. 10 - Maximum DC Antiparallel Diode Forward Current vs. Case Temperature per Junction

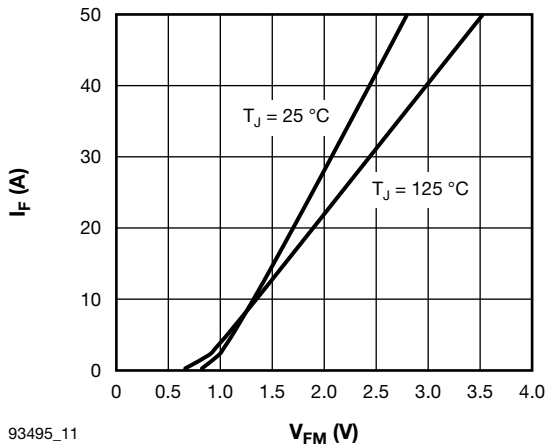

93495_11

Fig. 11 - Typical PFC Diode Forward Characteristics

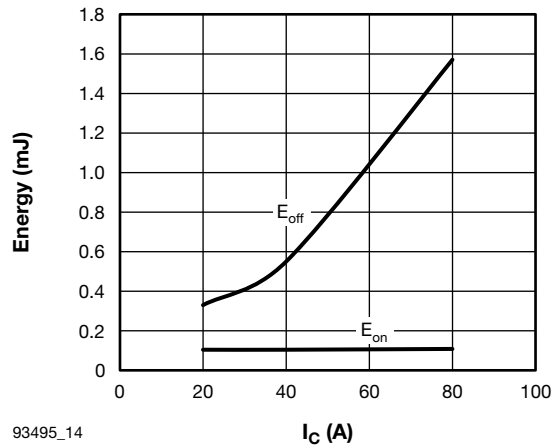

93495_14

Fig. 14 - Typical PFC IGBT Energy Loss vs. I_C
(with Freewheeling D3 - D4 PFC Diode)
 $T_J = 125\text{ }^\circ\text{C}$, $V_{CC} = 400\text{ V}$, $R_g = 4.7\text{ }\Omega$, $V_{GE} = 15\text{ V}$, $L = 500\text{ }\mu\text{H}$

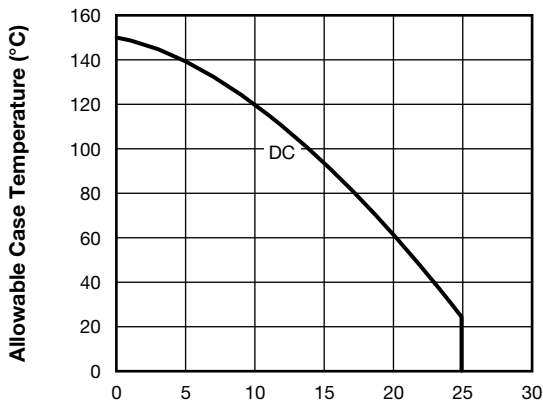

93495_12

Fig. 12 - Maximum DC PFC Diode Forward Current vs. Case Temperature per Junction

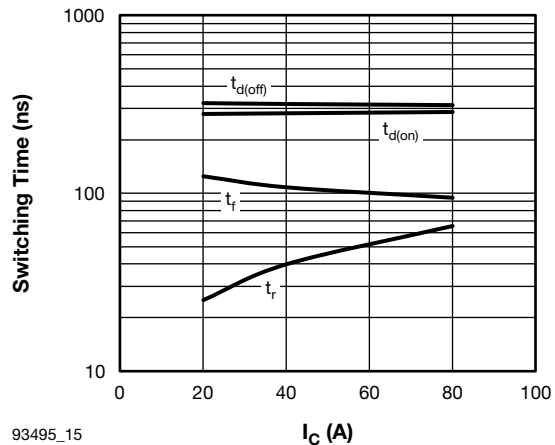

93495_15

Fig. 15 - Typical PFC IGBT Switching Time vs. I_C
(with Freewheeling D3 - D4 PFC Diode)
 $T_J = 125\text{ }^\circ\text{C}$, $V_{CC} = 400\text{ V}$, $R_g = 4.7\text{ }\Omega$, $V_{GE} = 15\text{ V}$, $L = 500\text{ }\mu\text{H}$

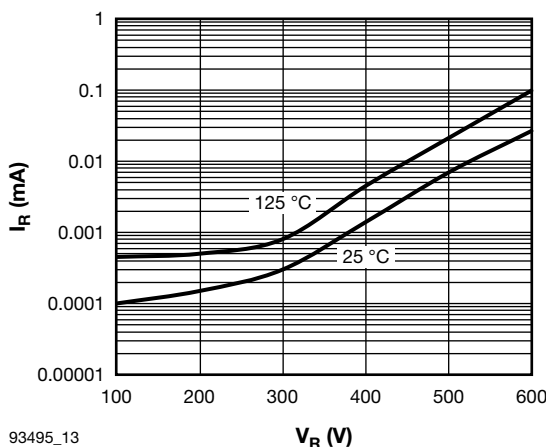

93495_13

Fig. 13 - Typical PFC Diode Reverse Leakage Current

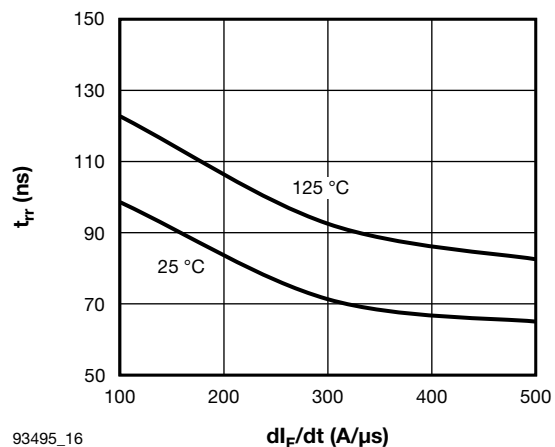

93495_16

Fig. 16 - Typical Antiparallel Reverse Recovery Time vs. di_F/dt
 $V_R = 200\text{ V}$, $I_F = 20\text{ A}$

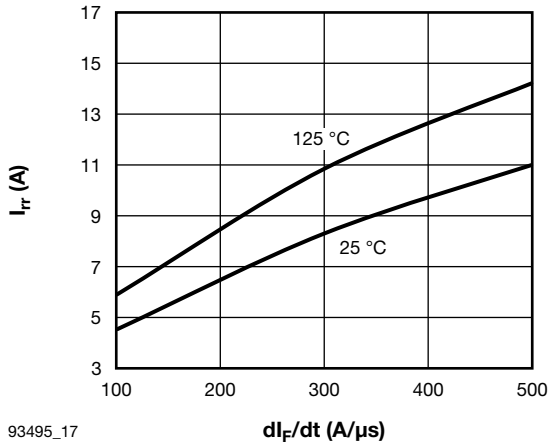

93495_17

Fig. 17 - Typical Antiparallel Reverse Recovery Current vs. di/dt
V_R = 200 V, I_F = 20 A

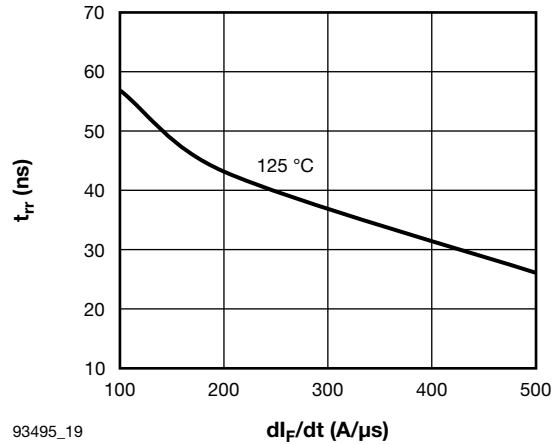

93495_19

Fig. 19 - Typical PFC Diode Reverse Recovery Time vs. di/dt
V_R = 200 V, I_F = 10 A

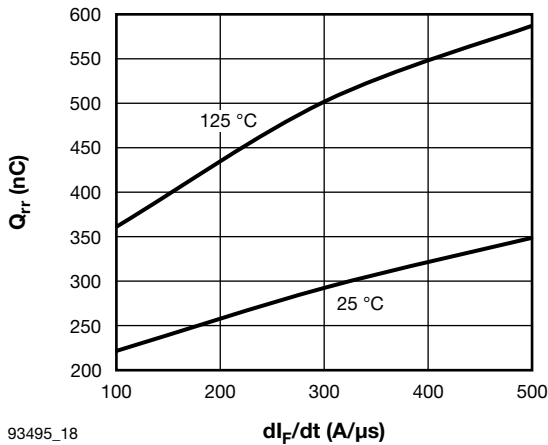

93495_18

Fig. 18 - Typical Antiparallel Reverse Recovery Charge vs. di/dt
V_R = 200 V, I_F = 20 A

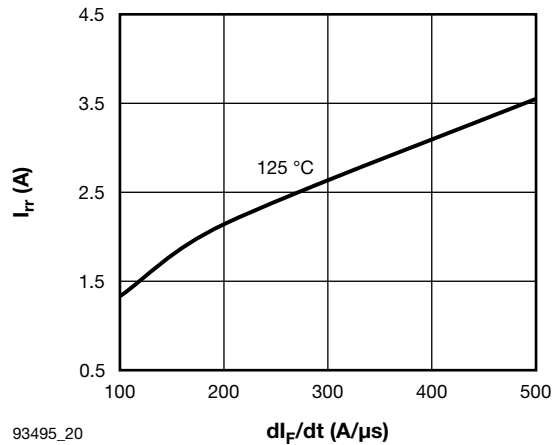

93495_20

Fig. 20 - Typical PFC Diode Reverse Recovery Current vs. di/dt
V_R = 200 V, I_F = 10 A

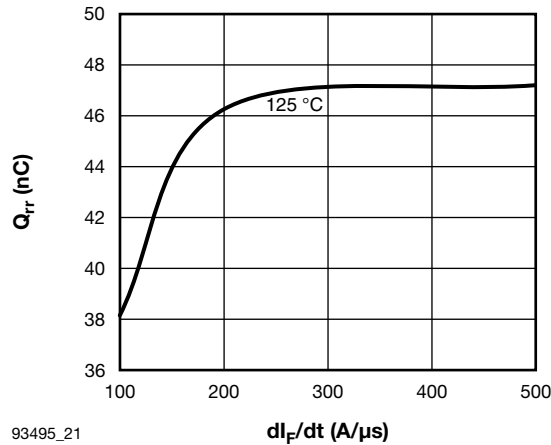

93495_21

Fig. 21 - Typical PFC Diode Reverse Recovery Charge vs. di/dt
V_R = 200 V, I_F = 10 A

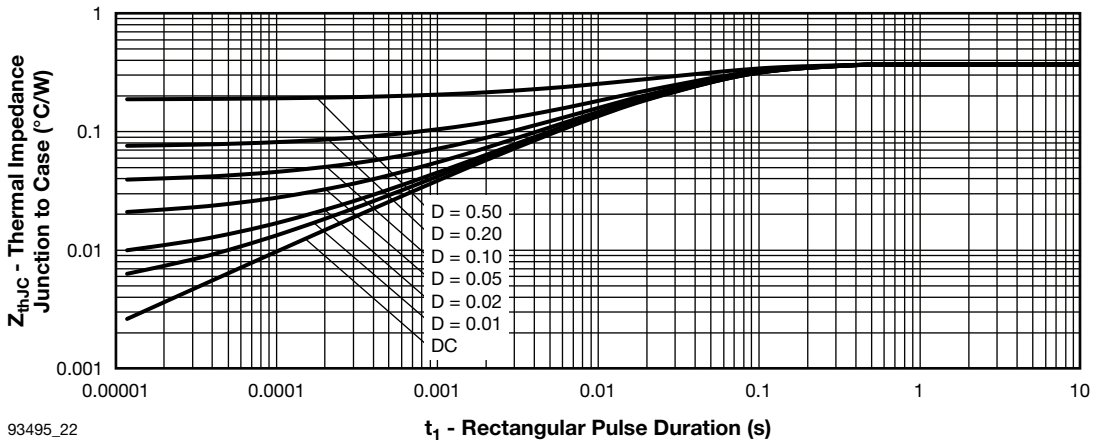

93495_22

Fig. 22 - Maximum Thermal Impedance Z_{thJC} Characteristics (IGBT)

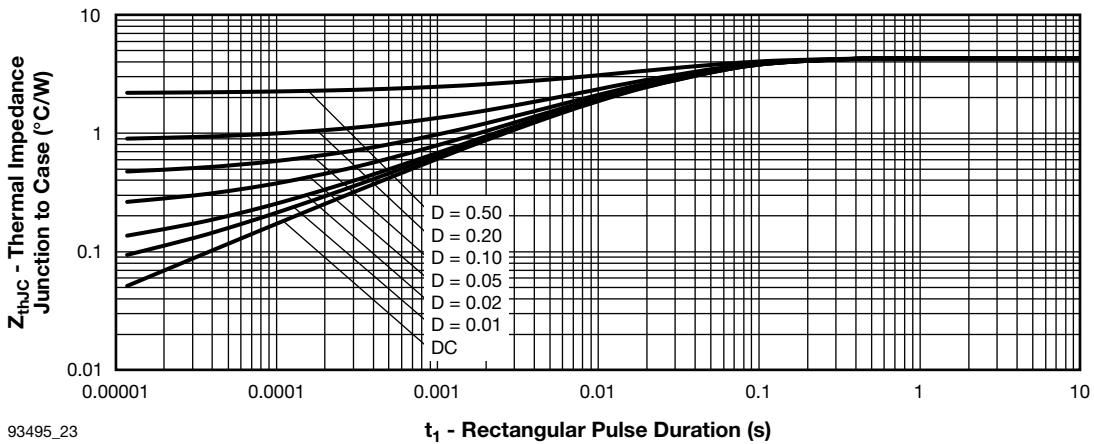

93495_23

Fig. 23 - Maximum Thermal Impedance Z_{thJC} Characteristics (Antiparallel Diode)

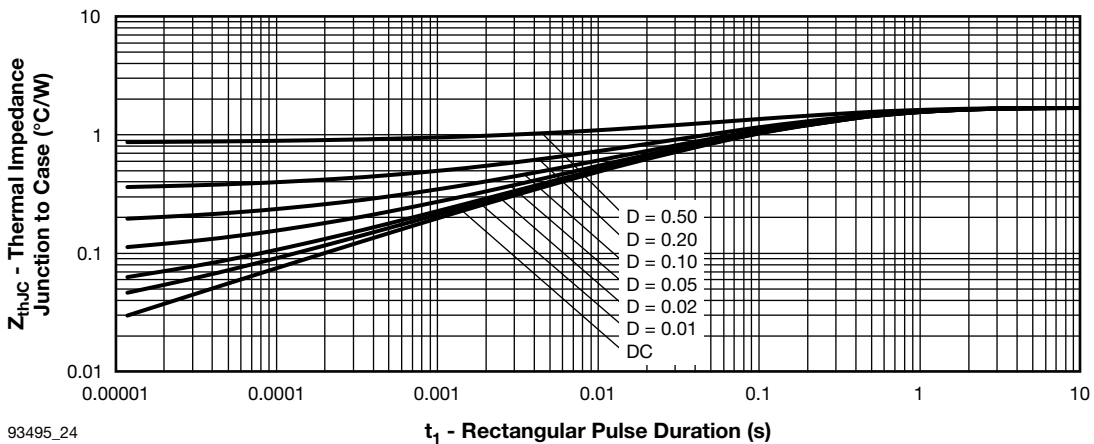

93495_24

Fig. 24 - Maximum Thermal Impedance Z_{thJC} Characteristics (PFC Diode)

ORDERING INFORMATION TABLE

Device code	VS-	EM	G	050	J	60	N
	①	②	③	④	⑤	⑥	⑦

- 1** - Vishay Semiconductors product
- 2** - Package indicator (EM = EMIPAK2)
- 3** - Circuit configuration (G = Dual mode PFC)
- 4** - Current rating (050 = 50 A)
- 5** - Die technology (J = Warp2 IGBT)
- 6** - Voltage rating (60 = 600 V)
- 7** - N = Ultrafast

TYPICAL CONNECTION

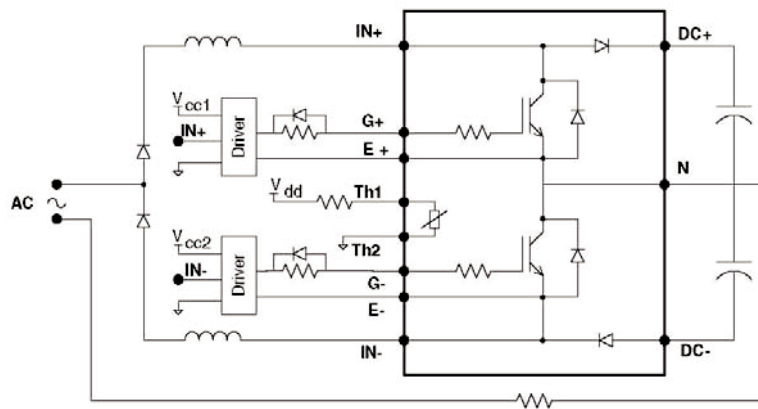

Note

- Please refer to lead assignment for correct pin configuration. This diagram shows electrical connections only.

CIRCUIT CONFIGURATION

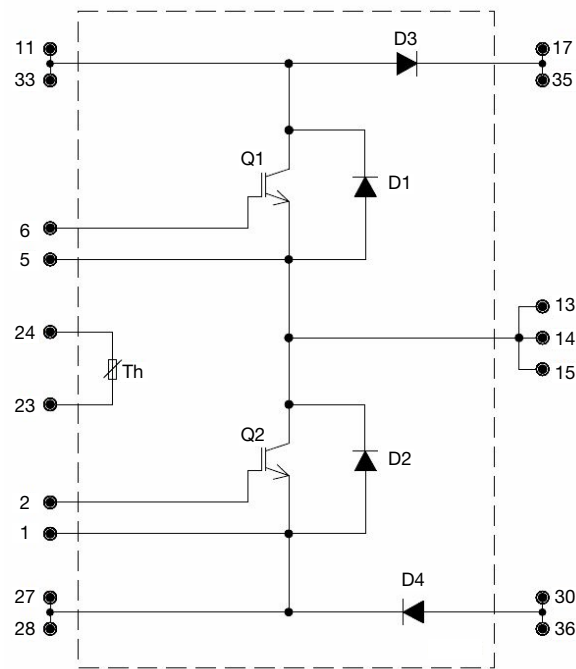

PACKAGE

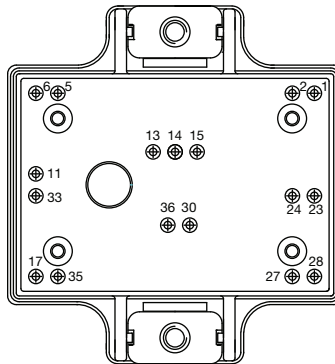

LINKS TO RELATED DOCUMENTS

Dimensions

www.vishay.com/doc?95436



Disclaimer

ALL PRODUCT, PRODUCT SPECIFICATIONS AND DATA ARE SUBJECT TO CHANGE WITHOUT NOTICE TO IMPROVE RELIABILITY, FUNCTION OR DESIGN OR OTHERWISE.

Vishay Intertechnology, Inc., its affiliates, agents, and employees, and all persons acting on its or their behalf (collectively, "Vishay"), disclaim any and all liability for any errors, inaccuracies or incompleteness contained in any datasheet or in any other disclosure relating to any product.

Vishay makes no warranty, representation or guarantee regarding the suitability of the products for any particular purpose or the continuing production of any product. To the maximum extent permitted by applicable law, Vishay disclaims (i) any and all liability arising out of the application or use of any product, (ii) any and all liability, including without limitation special, consequential or incidental damages, and (iii) any and all implied warranties, including warranties of fitness for particular purpose, non-infringement and merchantability.

Statements regarding the suitability of products for certain types of applications are based on Vishay's knowledge of typical requirements that are often placed on Vishay products in generic applications. Such statements are not binding statements about the suitability of products for a particular application. It is the customer's responsibility to validate that a particular product with the properties described in the product specification is suitable for use in a particular application. Parameters provided in datasheets and/or specifications may vary in different applications and performance may vary over time. All operating parameters, including typical parameters, must be validated for each customer application by the customer's technical experts. Product specifications do not expand or otherwise modify Vishay's terms and conditions of purchase, including but not limited to the warranty expressed therein.

Except as expressly indicated in writing, Vishay products are not designed for use in medical, life-saving, or life-sustaining applications or for any other application in which the failure of the Vishay product could result in personal injury or death. Customers using or selling Vishay products not expressly indicated for use in such applications do so at their own risk. Please contact authorized Vishay personnel to obtain written terms and conditions regarding products designed for such applications.

No license, express or implied, by estoppel or otherwise, to any intellectual property rights is granted by this document or by any conduct of Vishay. Product names and markings noted herein may be trademarks of their respective owners.

Material Category Policy

Vishay Intertechnology, Inc. hereby certifies that all its products that are identified as RoHS-Compliant fulfill the definitions and restrictions defined under Directive 2011/65/EU of The European Parliament and of the Council of June 8, 2011 on the restriction of the use of certain hazardous substances in electrical and electronic equipment (EEE) - recast, unless otherwise specified as non-compliant.

Please note that some Vishay documentation may still make reference to RoHS Directive 2002/95/EC. We confirm that all the products identified as being compliant to Directive 2002/95/EC conform to Directive 2011/65/EU.

Vishay Intertechnology, Inc. hereby certifies that all its products that are identified as Halogen-Free follow Halogen-Free requirements as per JEDEC JS709A standards. Please note that some Vishay documentation may still make reference to the IEC 61249-2-21 definition. We confirm that all the products identified as being compliant to IEC 61249-2-21 conform to JEDEC JS709A standards.