

“Low Side Chopper” IGBT SOT-227 (Warp 2 Speed IGBT), 70 A



SOT-227

PRIMARY CHARACTERISTICS	
V_{CES}	600 V
I_C DC	70 A at 87 °C
$V_{CE(on)}$ typical at 70 A, 25 °C	2.31 V
I_F DC	70 A at 86 °C
Package	SOT-227
Circuit configuration	Low side chopper

FEATURES

- NPT warp 2 speed IGBT technology with positive temperature coefficient
- Higher switching frequency up to 150 kHz
- Square RBSOA
- Low $V_{CE(on)}$
- FRED Pt[®] hyperfast rectifier
- Fully isolated package
- Very low internal inductance (≤ 5 nH typical)
- Industry standard outline
- UL approved file E78996 
- Material categorization: for definitions of compliance please see www.vishay.com/doc?99912

**RoHS
COMPLIANT**

BENEFITS

- Designed for increased operating efficiency in power conversion: UPS, SMPS, welding, induction heating
- Easy to assemble and parallel
- Direct mounting to heatsink
- Plug-in compatible with other SOT-227 packages
- Lower conduction losses and switching losses
- Low EMI, requires less snubbing

ABSOLUTE MAXIMUM RATINGS				
PARAMETER	SYMBOL	TEST CONDITIONS	MAX.	UNITS
Collector to emitter voltage	V_{CES}		600	V
Continuous collector current	I_C	$T_C = 25\text{ °C}$	109	A
		$T_C = 80\text{ °C}$	75	
Pulsed collector current	I_{CM}		120	
Clamped inductive load current	I_{LM}		120	
Diode continuous forward current	I_F	$T_C = 25\text{ °C}$	113	
		$T_C = 80\text{ °C}$	75	
Single pulse forward current	I_{FSM}	10 ms sine or 6 ms rectangular pulse, $T_J = 25\text{ °C}$	390	
Gate to emitter voltage	V_{GE}		± 20	
Power dissipation, IGBT	P_D	$T_C = 25\text{ °C}$	447	W
		$T_C = 80\text{ °C}$	250	
Power dissipation, diode	P_D	$T_C = 25\text{ °C}$	236	
		$T_C = 80\text{ °C}$	132	
RMS isolation voltage	V_{ISOL}	Any terminal to case, $t = 1$ min	2500	V



ELECTRICAL SPECIFICATIONS ($T_J = 25\text{ }^\circ\text{C}$ unless otherwise specified)						
PARAMETER	SYMBOL	TEST CONDITIONS	MIN.	TYP.	MAX.	UNITS
Collector to emitter breakdown voltage	$V_{BR(CES)}$	$V_{GE} = 0\text{ V}, I_C = 1\text{ mA}$	600	-	-	V
Collector to emitter voltage	$V_{CE(on)}$	$V_{GE} = 15\text{ V}, I_C = 35\text{ A}$	-	1.73	2.0	
		$V_{GE} = 15\text{ V}, I_C = 70\text{ A}$	-	2.31	-	
		$V_{GE} = 15\text{ V}, I_C = 35\text{ A}, T_J = 125\text{ }^\circ\text{C}$	-	2.14	-	
		$V_{GE} = 15\text{ V}, I_C = 70\text{ A}, T_J = 125\text{ }^\circ\text{C}$	-	3.0	-	
Gate threshold voltage	$V_{GE(th)}$	$V_{CE} = V_{GE}, I_C = 500\text{ }\mu\text{A}$	2.7	4.5	5.4	
Temperature coefficient of threshold voltage	$\Delta V_{GE(th)}/\Delta T_J$	$V_{CE} = V_{GE}, I_C = 1\text{ mA}$ ($25\text{ }^\circ\text{C}$ to $125\text{ }^\circ\text{C}$)	-	-10.8	-	mV/ $^\circ\text{C}$
Collector to emitter leakage current	I_{CES}	$V_{GE} = 0\text{ V}, V_{CE} = 600\text{ V}$	-	5	50	μA
		$V_{GE} = 0\text{ V}, V_{CE} = 600\text{ V}, T_J = 125\text{ }^\circ\text{C}$	-	0.17	-	mA
Diode reverse breakdown voltage	V_{BR}	$I_R = 1\text{ mA}$	600	-	-	V
Diode forward voltage drop	V_{FM}	$I_F = 35\text{ A}, V_{GE} = 0\text{ V}$	-	1.67	2.33	V
		$I_F = 70\text{ A}, V_{GE} = 0\text{ V}$	-	1.96	-	
		$I_F = 35\text{ A}, V_{GE} = 0\text{ V}, T_J = 125\text{ }^\circ\text{C}$	-	1.23	-	
		$I_F = 70\text{ A}, V_{GE} = 0\text{ V}, T_J = 125\text{ }^\circ\text{C}$	-	1.55	-	
Diode reverse leakage current	I_{RM}	$V_R = 600\text{ V}$	-	0.1	50	μA
		$T_J = 125\text{ }^\circ\text{C}, V_R = 600\text{ V}$	-	0.04	-	mA
Gate to emitter leakage current	I_{GES}	$V_{GE} = \pm 20\text{ V}$	-	-	± 200	nA

SWITCHING CHARACTERISTICS ($T_J = 25\text{ }^\circ\text{C}$ unless otherwise specified)							
PARAMETER	SYMBOL	TEST CONDITIONS	MIN.	TYP.	MAX.	UNITS	
Total gate charge (turn-on)	Q_g	$I_C = 50\text{ A}, V_{CC} = 400\text{ V}, V_{GE} = 15\text{ V}$	-	320	-	nC	
Gate to emitter charge (turn-on)	Q_{ge}		-	42	-		
Gate to collector charge (turn-on)	Q_{gc}		-	110	-		
Turn-on switching loss	E_{on}	$I_C = 70\text{ A}, V_{CC} = 300\text{ V}, V_{GE} = 15\text{ V}, R_g = 4.7\text{ }\Omega, L = 500\text{ }\mu\text{H}, T_J = 25\text{ }^\circ\text{C}$ Energy losses include tail and diode recovery	-	0.33	-	mJ	
Turn-off switching loss	E_{off}		-	0.46	-		
Total switching loss	E_{tot}		-	0.79	-		
Turn-on switching loss	E_{on}		-	0.51	-		
Turn-off switching loss	E_{off}		-	0.56	-		
Total switching loss	E_{tot}		-	1.07	-		
Turn-on delay time	$t_{d(on)}$		$I_C = 70\text{ A}, V_{CC} = 300\text{ V}, V_{GE} = 15\text{ V}, R_g = 4.7\text{ }\Omega, L = 500\text{ }\mu\text{H}, T_J = 125\text{ }^\circ\text{C}$	-	166	-	ns
Rise time	t_r			-	44	-	
Turn-off delay time	$t_{d(off)}$			-	188	-	
Fall time	t_f			-	53	-	
Reverse bias safe operating area	RBSOA	$T_J = 150\text{ }^\circ\text{C}, I_C = 120\text{ A}, R_g = 22\text{ }\Omega, V_{GE} = 15\text{ V to } 0\text{ V}, V_{CC} = 400\text{ V}, V_P = 600\text{ V}$	Fullsquare				
Diode reverse recovery time	t_{rr}	$I_F = 50\text{ A}, di/dt = 200\text{ A}/\mu\text{s}, V_R = 200\text{ V}$	-	64	-	ns	
Diode peak reverse current	I_{rr}		-	4.5	-	A	
Diode recovery charge	Q_{rr}		-	144	-	nC	
Diode reverse recovery time	t_{rr}	$I_F = 50\text{ A}, di/dt = 200\text{ A}/\mu\text{s}, V_R = 200\text{ V}, T_J = 125\text{ }^\circ\text{C}$	-	136	-	ns	
Diode peak reverse current	I_{rr}		-	12	-	A	
Diode recovery charge	Q_{rr}		-	807	-	nC	



THERMAL AND MECHANICAL SPECIFICATIONS						
PARAMETER	SYMBOL	TEST CONDITIONS	MIN.	TYP.	MAX.	UNITS
Junction and storage temperature range	T_J, T_{Stg}		-40	-	150	°C
Junction to case	IGBT		-	-	0.28	°C/W
	Diode		-	-	0.53	
Case to heatsink	R_{thCS}	Flat, greased surface	-	0.05	-	
Weight			-	30	-	g
Mounting torque		Torque to terminal	-	-	1.1 (9.7)	Nm (lbf.in)
		Torque to heatsink	-	-	1.8 (15.9)	Nm (lbf.in)
Case style		SOT-227				

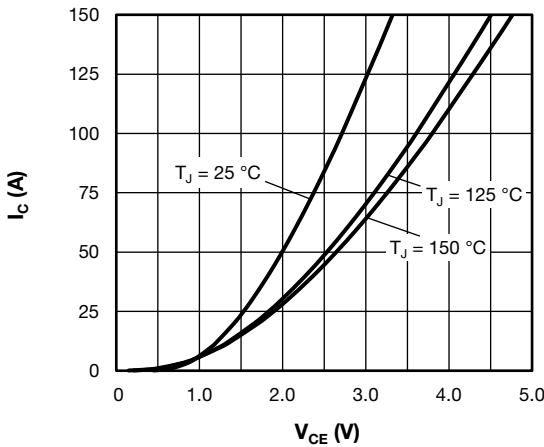

Fig. 1 - Typical IGBT Output Characteristics, $V_{GE} = 15\text{ V}$

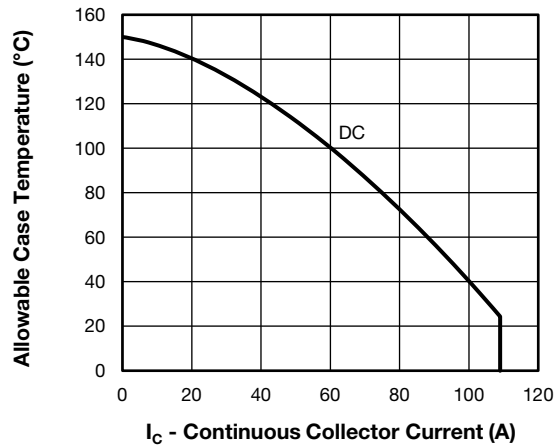

Fig. 3 - Maximum IGBT Continuous Collector Current vs. Case Temperature

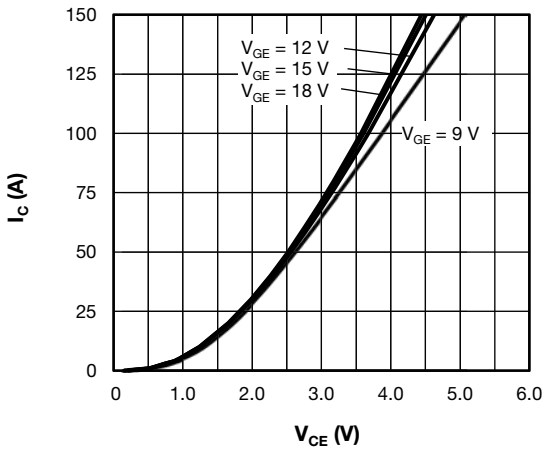

Fig. 2 - Typical IGBT Output Characteristics, $T_J = 125\text{ °C}$

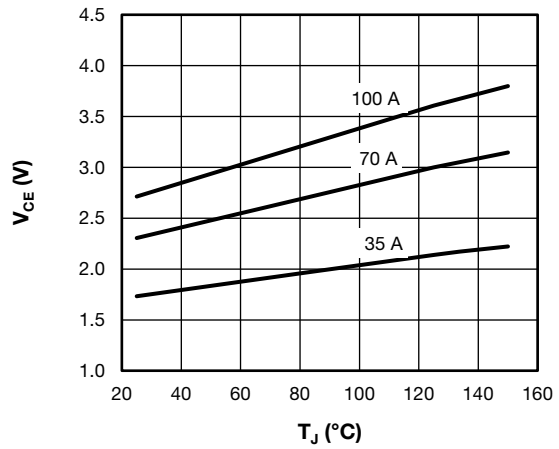

Fig. 4 - Collector to Emitter Voltage vs. Junction Temperature

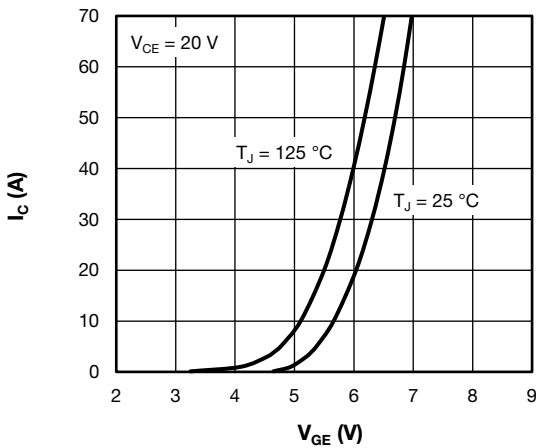

Fig. 5 - Typical IGBT Transfer Characteristics

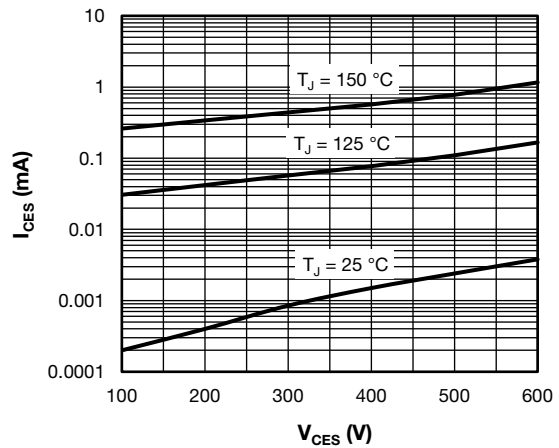

Fig. 8 - Typical IGBT Zero Gate Voltage Collector Current

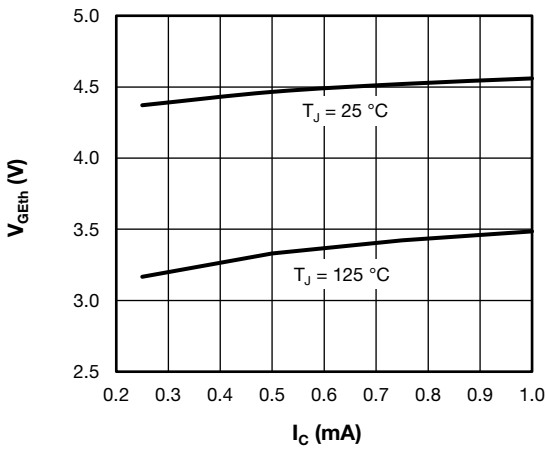

Fig. 6 - Typical IGBT Gate Threshold Voltage

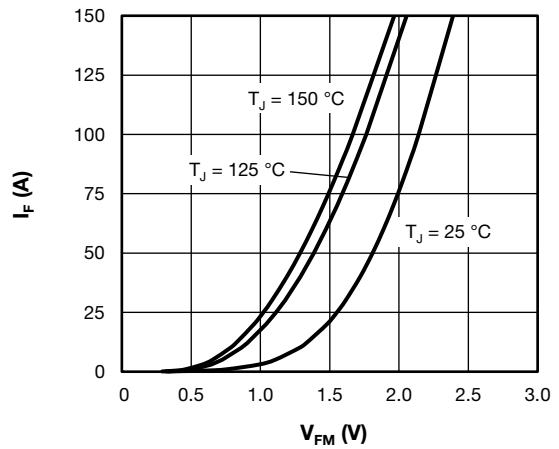

Fig. 9 - Typical Diode Forward Characteristics

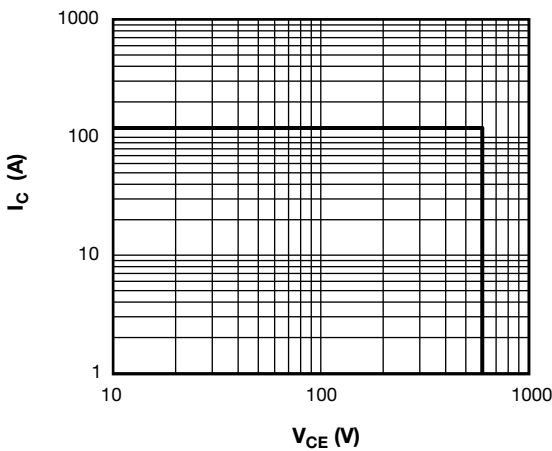

Fig. 7 - IGBT Reverse BIAS SOA,
 $T_J = 150\text{ }^\circ\text{C}$, $V_{GE} = 15\text{ V}$

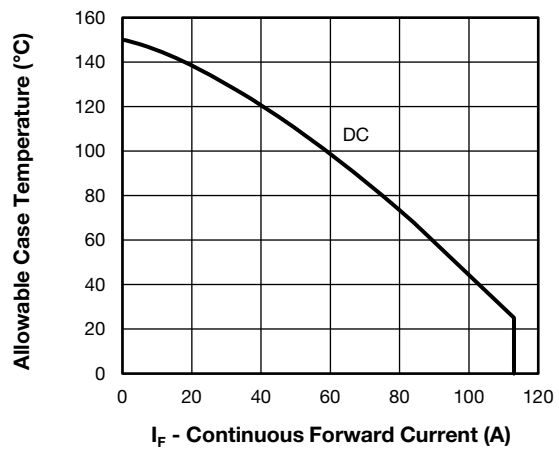

Fig. 10 - Maximum Diode Continuous Forward Current vs. Case Temperature

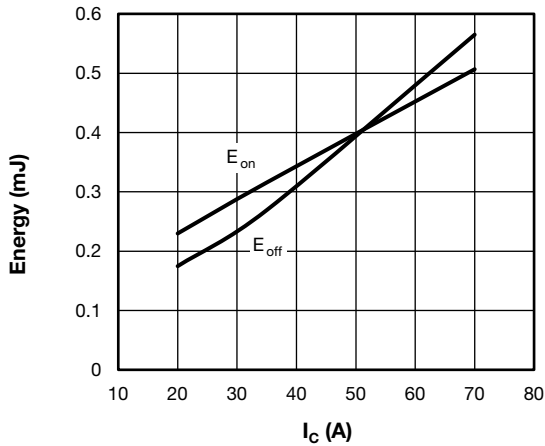

Fig. 11 - Typical IGBT Energy Loss vs. I_C
 $T_J = 125\text{ }^\circ\text{C}$, $V_{CC} = 300\text{ V}$, $R_g = 4.7\ \Omega$, $V_{GE} = 15\text{ V}$, $L = 500\ \mu\text{H}$

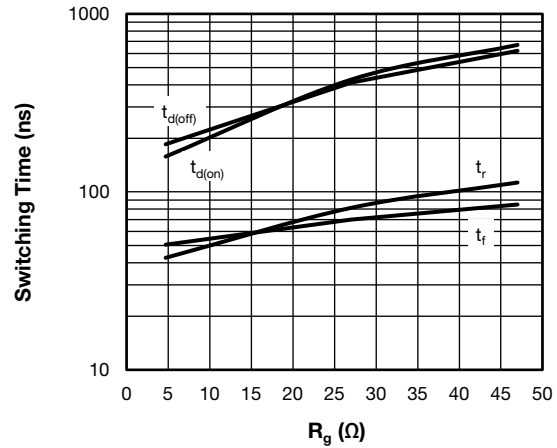

Fig. 14 - Typical IGBT Switching Time vs. R_g
 $T_J = 125\text{ }^\circ\text{C}$, $V_{CC} = 300\text{ V}$, $I_C = 70\text{ A}$, $V_{GE} = 15\text{ V}$, $L = 500\ \mu\text{H}$

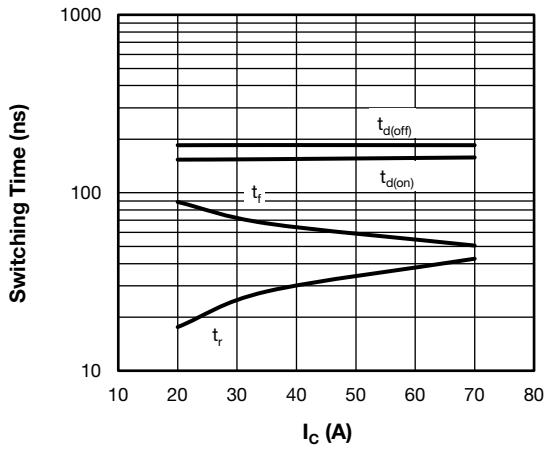

Fig. 12 - Typical IGBT Switching Time vs. I_C
 $T_J = 125\text{ }^\circ\text{C}$, $V_{CC} = 300\text{ V}$, $R_g = 4.7\ \Omega$, $V_{GE} = 15\text{ V}$, $L = 500\ \mu\text{H}$

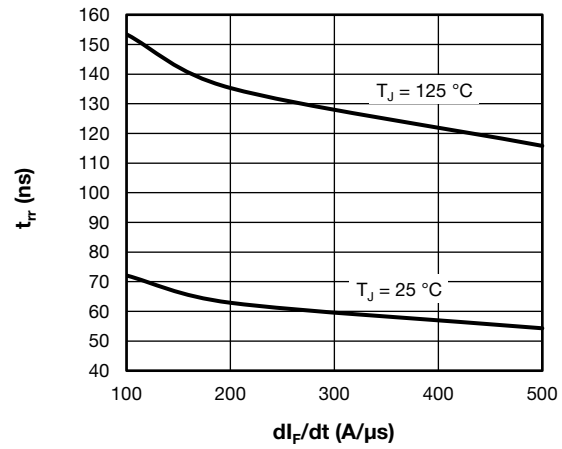

Fig. 15 - Typical Diode Reverse Recovery Time vs. di_F/dt
 $V_{rr} = 200\text{ V}$, $I_F = 50\text{ A}$

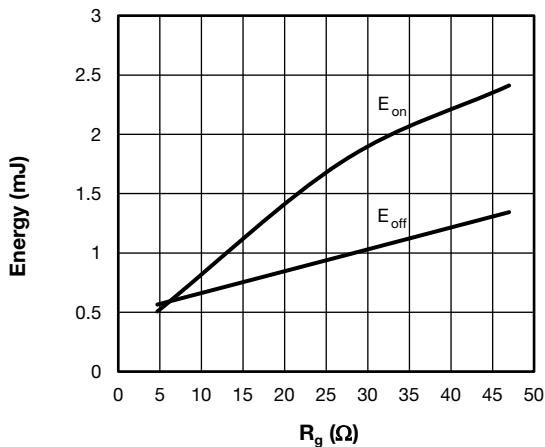

Fig. 13 - Typical IGBT Energy Loss vs. R_g
 $T_J = 125\text{ }^\circ\text{C}$, $V_{CC} = 300\text{ V}$, $I_C = 70\text{ A}$, $V_{GE} = 15\text{ V}$, $L = 500\ \mu\text{H}$

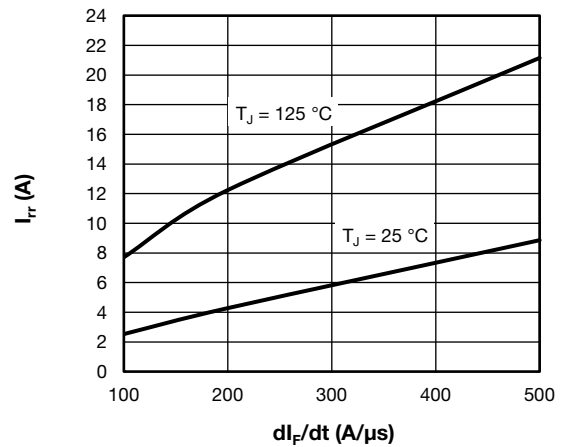

Fig. 16 - Typical Diode Reverse Recovery Current vs. di_F/dt
 $V_{rr} = 200\text{ V}$, $I_F = 50\text{ A}$

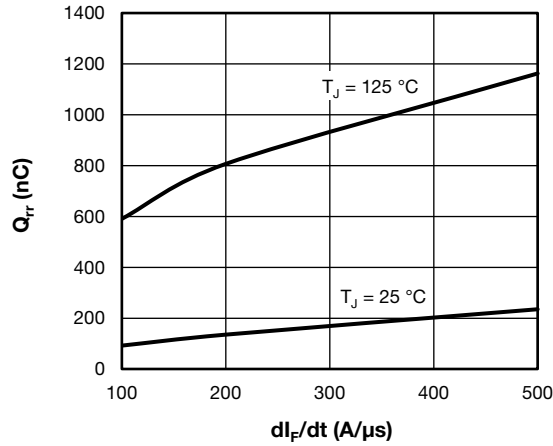

Fig. 17 - Typical Diode Reverse Recovery Charge vs. di_F/dt
 $V_{rr} = 200\text{ V}$, $I_F = 50\text{ A}$

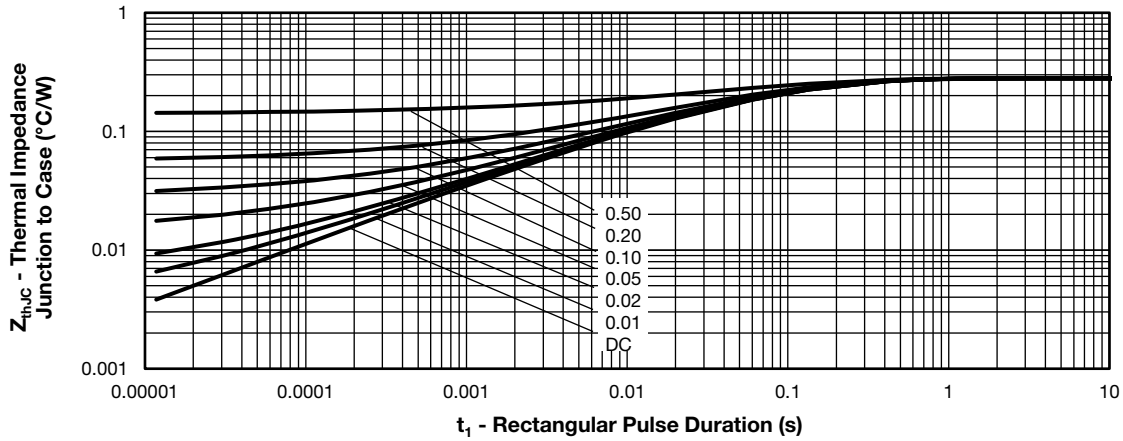

Fig. 18 - Maximum Thermal Impedance Z_{thJC} Characteristics (IGBT)

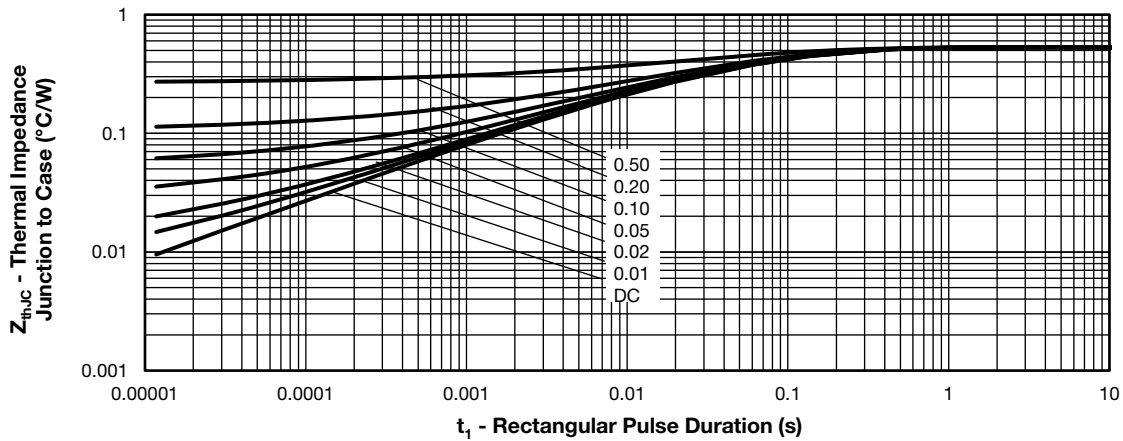

Fig. 19 - Maximum Thermal Impedance Z_{thJC} Characteristics (Diode)

ORDERING INFORMATION TABLE

Device code	VS-	G	B	75	L	A	60	U	F
	1	2	3	4	5	6	7	8	9

- 1** - Vishay Semiconductors product
- 2** - Insulated gate bipolar transistor (IGBT)
- 3** - B = IGBT Gen 5
- 4** - Current rating (75 = 70 A)
- 5** - Circuit configuration (L = low side chopper)
- 6** - Package indicator (A = SOT-227)
- 7** - Voltage rating (60 = 600 V)
- 8** - Speed/type (U = ultrafast IGBT)
- 9** - Diode (F = FRED Pt[®] diode)

CIRCUIT CONFIGURATION		
CIRCUIT	CIRCUIT CONFIGURATION CODE	CIRCUIT DRAWING
Low side chopper	L	<p>Lead Assignment</p>

LINKS TO RELATED DOCUMENTS	
Dimensions	www.vishay.com/doc?95423
Packaging information	www.vishay.com/doc?95425



DIMENSIONS in millimeters (inches)

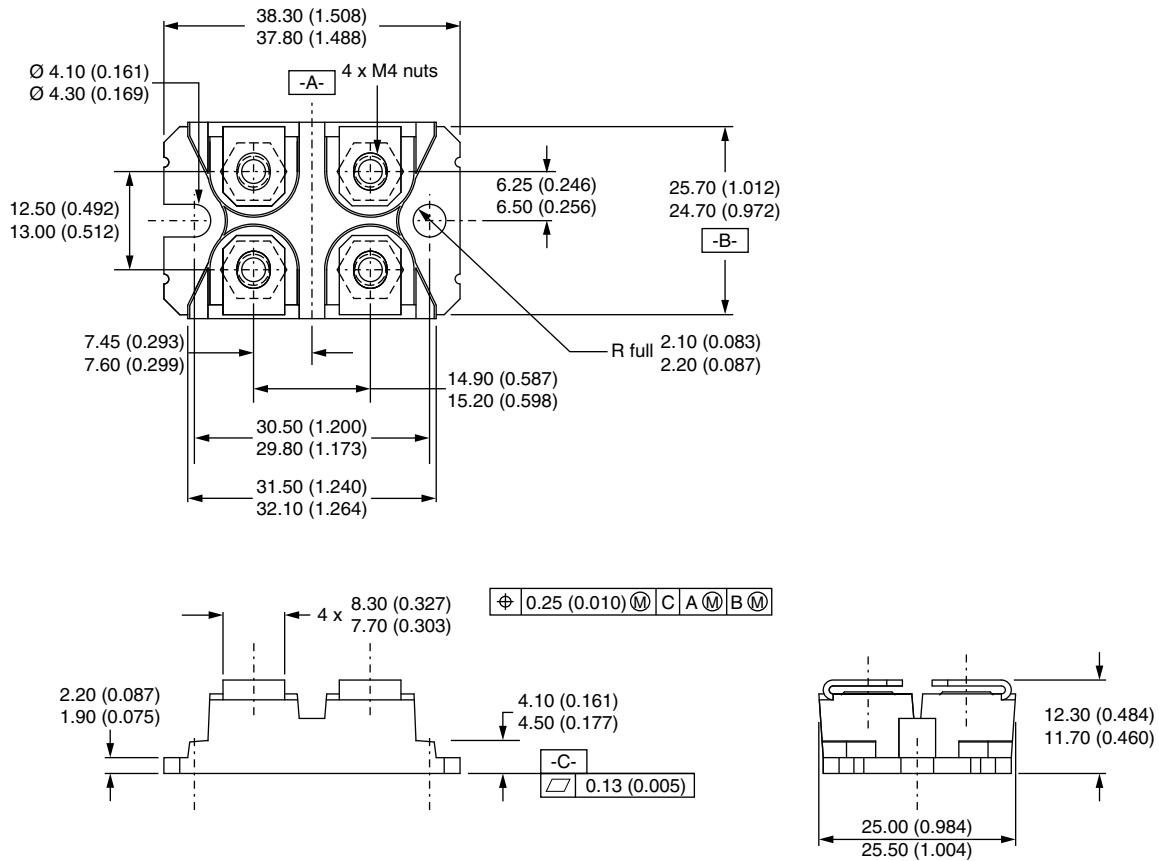

Note

- Controlling dimension: millimeter

PACKAGING INFORMATION

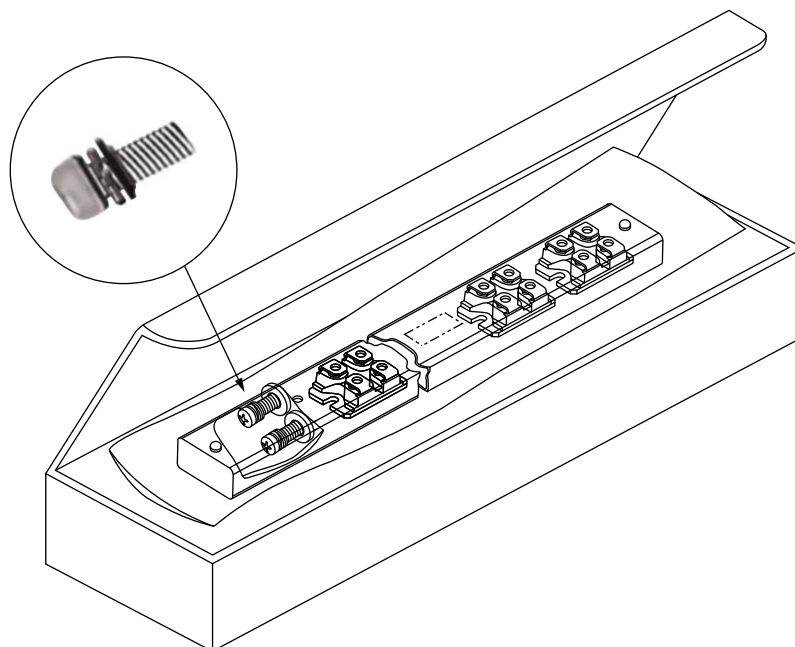



Disclaimer

ALL PRODUCT, PRODUCT SPECIFICATIONS AND DATA ARE SUBJECT TO CHANGE WITHOUT NOTICE TO IMPROVE RELIABILITY, FUNCTION OR DESIGN OR OTHERWISE.

Vishay Intertechnology, Inc., its affiliates, agents, and employees, and all persons acting on its or their behalf (collectively, "Vishay"), disclaim any and all liability for any errors, inaccuracies or incompleteness contained in any datasheet or in any other disclosure relating to any product.

Vishay makes no warranty, representation or guarantee regarding the suitability of the products for any particular purpose or the continuing production of any product. To the maximum extent permitted by applicable law, Vishay disclaims (i) any and all liability arising out of the application or use of any product, (ii) any and all liability, including without limitation special, consequential or incidental damages, and (iii) any and all implied warranties, including warranties of fitness for particular purpose, non-infringement and merchantability.

Statements regarding the suitability of products for certain types of applications are based on Vishay's knowledge of typical requirements that are often placed on Vishay products in generic applications. Such statements are not binding statements about the suitability of products for a particular application. It is the customer's responsibility to validate that a particular product with the properties described in the product specification is suitable for use in a particular application. Parameters provided in datasheets and / or specifications may vary in different applications and performance may vary over time. All operating parameters, including typical parameters, must be validated for each customer application by the customer's technical experts. Product specifications do not expand or otherwise modify Vishay's terms and conditions of purchase, including but not limited to the warranty expressed therein.

Except as expressly indicated in writing, Vishay products are not designed for use in medical, life-saving, or life-sustaining applications or for any other application in which the failure of the Vishay product could result in personal injury or death. Customers using or selling Vishay products not expressly indicated for use in such applications do so at their own risk. Please contact authorized Vishay personnel to obtain written terms and conditions regarding products designed for such applications.

No license, express or implied, by estoppel or otherwise, to any intellectual property rights is granted by this document or by any conduct of Vishay. Product names and markings noted herein may be trademarks of their respective owners.