

## Features

- P-Channel, -5V Logic Level Control
- Low on-resistance  $R_{DS(on)}$  @  $V_{GS}=-4.5V$
- Fast Switching
- Enhancement mode
- 100% Avalanche Tested
- Pb-free lead plating; RoHS compliant



Part ID	Package Type	Marking	Tape and reel information
VS3510AP	PDFN5x6	3510AP	3000pcs/reel

$V_{DS}$	-30	V
$R_{DS(on),TYP} @ V_{GS}=-10V$	10	m $\Omega$
$R_{DS(on),TYP} @ V_{GS}=-4.5V$	17	m $\Omega$
$I_D$	-45	A

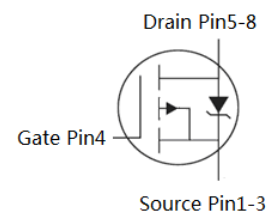
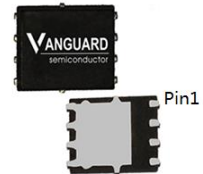
**PDFN5x6**

**Maximum ratings, at  $T_j=25^\circ\text{C}$ , unless otherwise specified**

Symbol	Parameter	Rating	Unit
$V_{(BR)DSS}$	Drain-Source breakdown voltage	-30	V
$I_S$	Diode continuous forward current	$T_C=25^\circ\text{C}$	A
$I_D$	Continuous drain current @ $V_{GS}=-10V$	$T_C=25^\circ\text{C}$	A
		$T_C=100^\circ\text{C}$	A
$I_{DM}$	Pulse drain current tested ①	$T_C=25^\circ\text{C}$	A
EAS	Avalanche energy, single pulsed ②	56	mJ
$P_D$	Maximum power dissipation	$T_C=25^\circ\text{C}$	W
$V_{GS}$	Gate-Source voltage	$\pm 20$	V
$T_{STG} T_J$	Storage and operating temperature range	-55 to 150	$^\circ\text{C}$

## Thermal Characteristics

Symbol	Parameter	Typical	Unit
$R_{\theta JC}$	Thermal Resistance-Junction to Case	3.4	$^\circ\text{C/W}$
$R_{\theta JA}$	Thermal Resistance-Junction to Ambient	30	$^\circ\text{C/W}$

Symbol	Parameter	Condition	Min.	Typ.	Max.	Unit
<b>Static Electrical Characteristics @ T<sub>J</sub> = 25°C (unless otherwise stated)</b>						
V <sub>(BR)DSS</sub>	Drain-Source Breakdown Voltage	V <sub>GS</sub> =0V, I <sub>D</sub> =-250μA	-30	--	--	V
I <sub>DSS</sub>	Zero Gate Voltage Drain Current(Tc=25°C)	V <sub>DS</sub> =-30V, V <sub>GS</sub> =0V	--	--	-1	μA
	Zero Gate Voltage Drain Current(Tc=125°C)	V <sub>DS</sub> =-30V, V <sub>GS</sub> =0V	--	--	-100	μA
I <sub>GSS</sub>	Gate-Body Leakage Current	V <sub>GS</sub> =±20V, V <sub>DS</sub> =0V	--	--	±100	nA
V <sub>GS(TH)</sub>	Gate Threshold Voltage	V <sub>DS</sub> =V <sub>GS</sub> , I <sub>D</sub> =-250μA	-1.3	-1.8	-2.4	V
R <sub>DS(ON)</sub>	Drain-Source On-State Resistance ③	V <sub>GS</sub> =-10V, I <sub>D</sub> =-20A	--	10	13	mΩ
R <sub>DS(ON)</sub>	Drain-Source On-State Resistance ③	V <sub>GS</sub> =-4.5V, I <sub>D</sub> =-15A	--	17	22	mΩ
<b>Dynamic Electrical Characteristics @ T<sub>J</sub> = 25°C (unless otherwise stated)</b>						
C <sub>iss</sub>	Input Capacitance	V <sub>DS</sub> =-15V, V <sub>GS</sub> =0V, f=1MHz	1700	1870	2000	pF
C <sub>oss</sub>	Output Capacitance		200	300	380	pF
C <sub>rss</sub>	Reverse Transfer Capacitance		100	200	260	pF
R <sub>g</sub>	Gate Resistance	f=1MHz	--	4.5	--	Ω
Q <sub>g</sub>	Total Gate Charge	V <sub>DS</sub> =-15V, I <sub>D</sub> =-20A, V <sub>GS</sub> =-10V	--	39	--	nC
Q <sub>gs</sub>	Gate-Source Charge		--	7	--	nC
Q <sub>gd</sub>	Gate-Drain Charge		--	13	--	nC
<b>Switching Characteristics</b>						
t <sub>d(on)</sub>	Turn-on Delay Time	V <sub>DD</sub> =-15V, I <sub>D</sub> =-20A, R <sub>G</sub> =3Ω, V <sub>GS</sub> =-10V	--	10.1	--	nS
t <sub>r</sub>	Turn-on Rise Time		--	10.6	--	nS
t <sub>d(off)</sub>	Turn-Off Delay Time		--	31	--	nS
t <sub>f</sub>	Turn-Off Fall Time		--	10	--	nS
<b>Source- Drain Diode Characteristics @ T<sub>J</sub> = 25°C (unless otherwise stated)</b>						
V <sub>SD</sub>	Forward on voltage	I <sub>SD</sub> =-20A, V <sub>GS</sub> =0V	--	-0.9	-1.2	V
t <sub>rr</sub>	Reverse Recovery Time	T <sub>J</sub> =25°C, I <sub>sd</sub> =-20A, V <sub>GS</sub> =0V	--	16	--	nS
Q <sub>rr</sub>	Reverse Recovery Charge	di/dt=-500A/μs		42		nC

NOTE:

- ① Repetitive rating; pulse width limited by max. junction temperature.
- ② Limited by T<sub>Jmax</sub>, starting T<sub>J</sub> = 25°C, L = 0.5mH, R<sub>G</sub> = 25Ω, I<sub>AS</sub> = -15A, V<sub>GS</sub> = -10V. Part not recommended for use above this value
- ③ Pulse width ≤ 300μs; duty cycle ≤ 2%.



Typical Characteristics

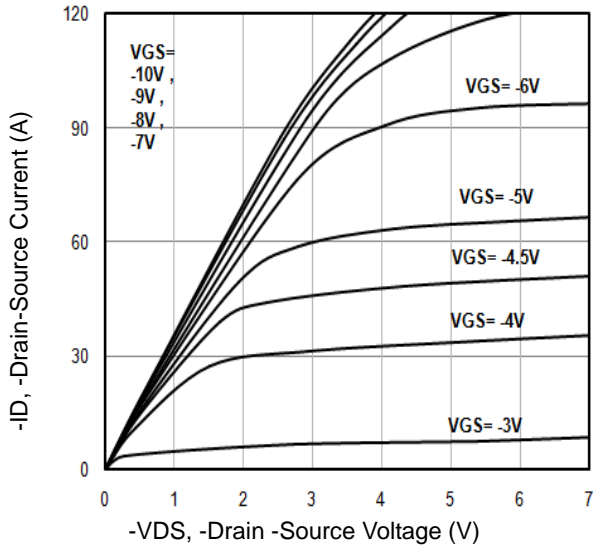

Fig1. Typical Output Characteristics

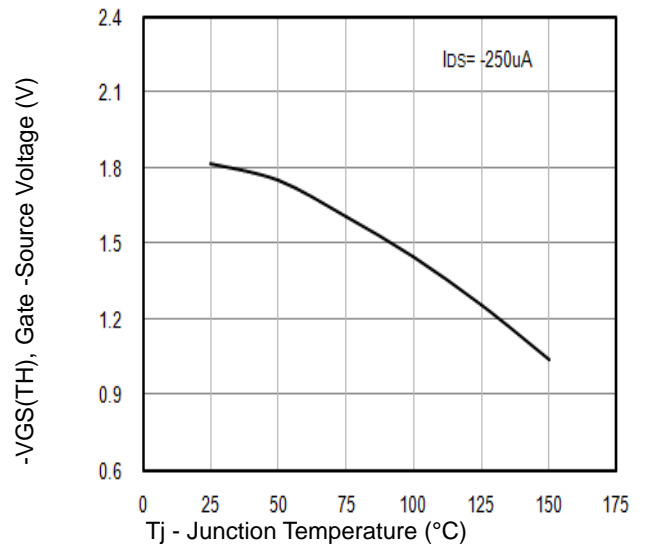

Fig2.  $-V_{GS(TH)}$  Gate -Source Voltage Vs.  $T_j$

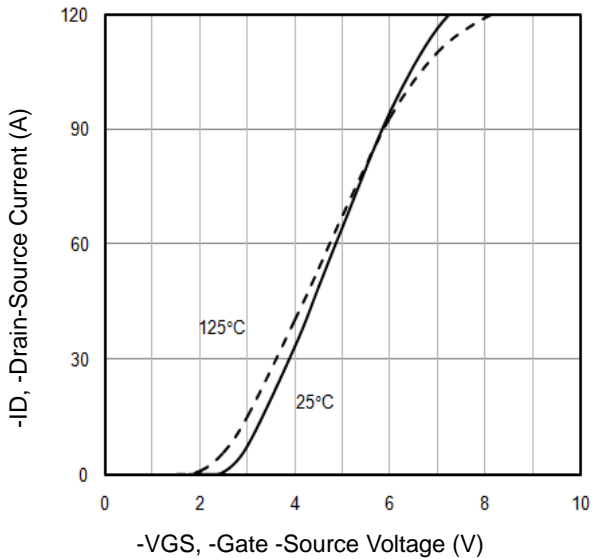

Fig3. Typical Transfer Characteristics

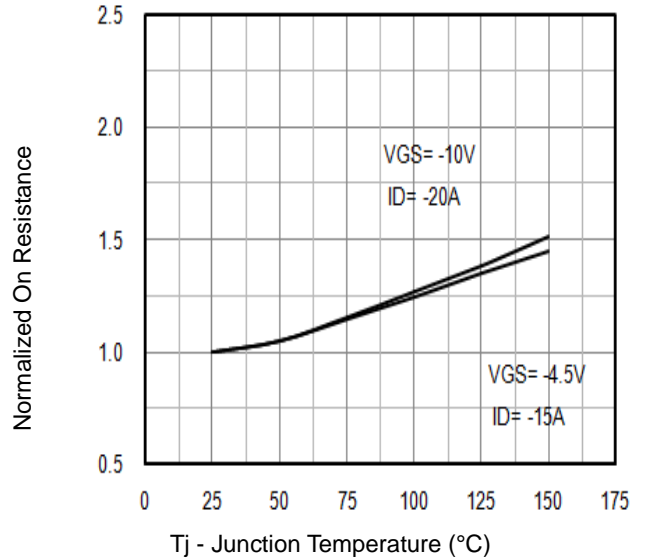

Fig4. Normalized On-Resistance Vs.  $T_j$

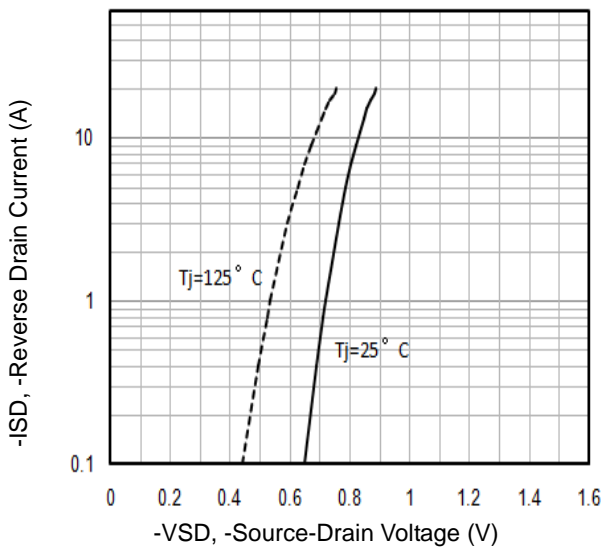

Fig5. Typical Source-Drain Diode Forward Voltage

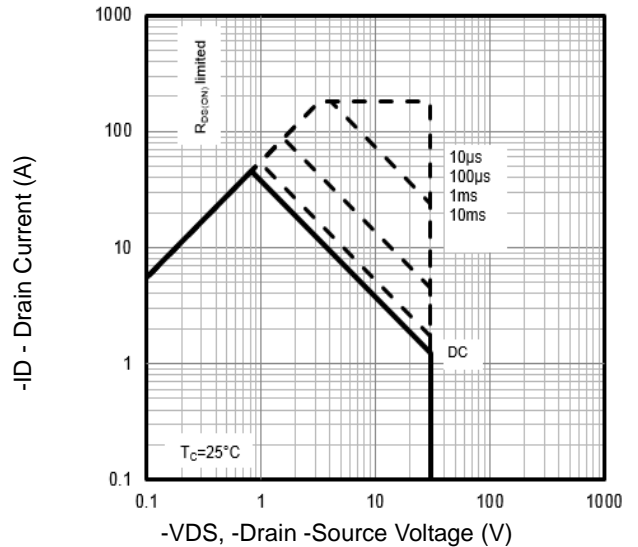

Fig6. Maximum Safe Operating Area

Typical Characteristics

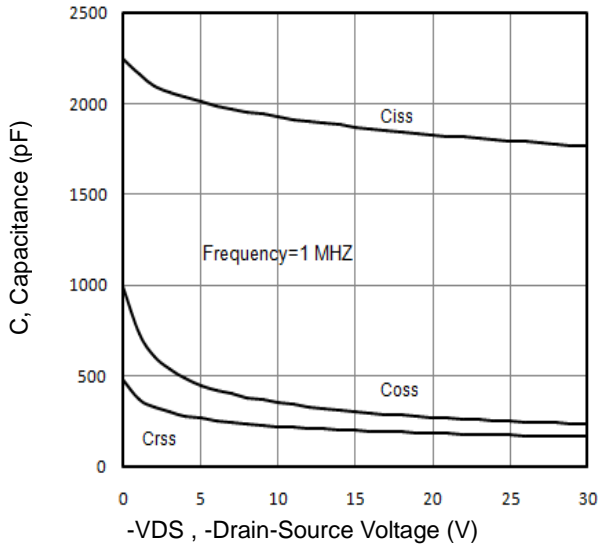

Fig7. Typical Capacitance Vs.Drain-Source Voltage

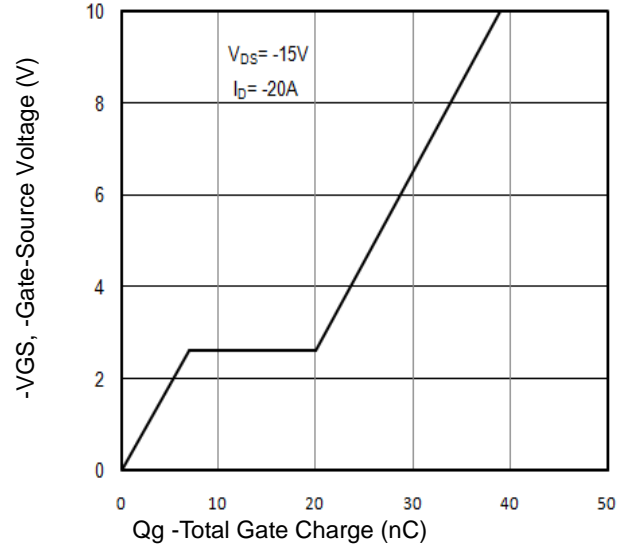

Fig8. Typical Gate Charge Vs.Gate-Source Voltage

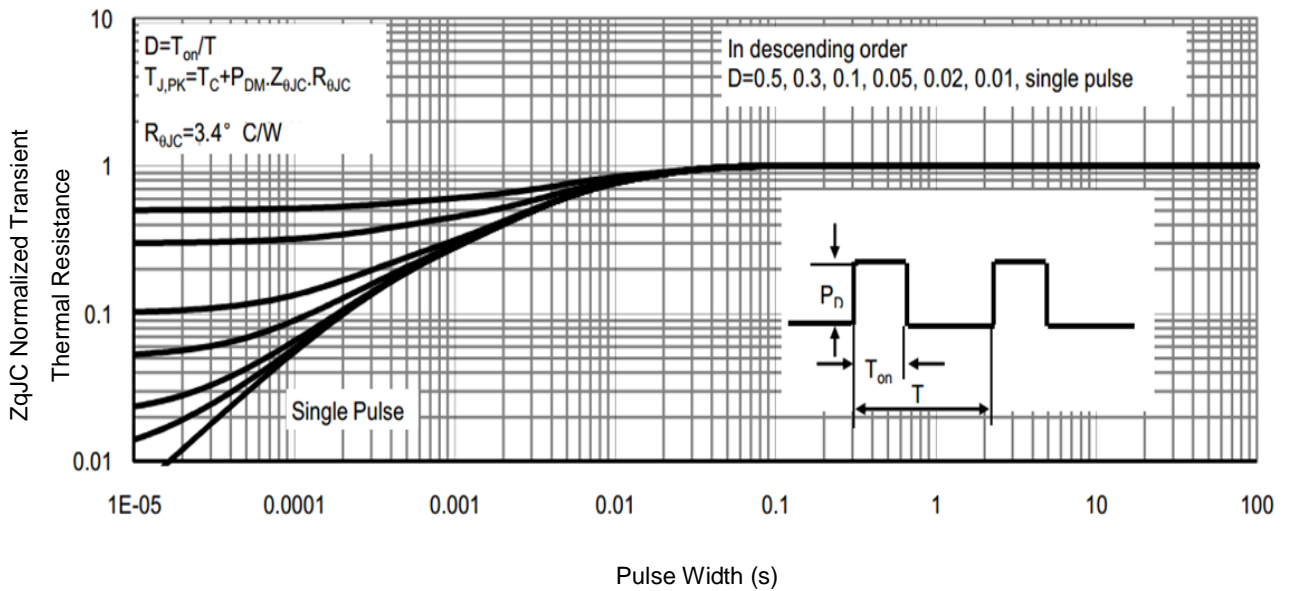

Fig9. Normalized Maximum Transient Thermal Impedance

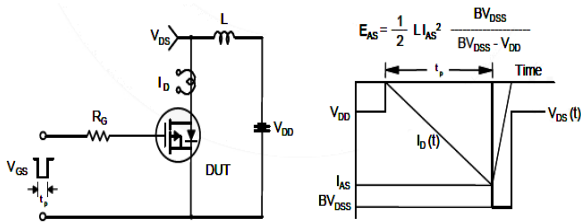

Fig10. Unclamped Inductive Test Circuit and Waveforms

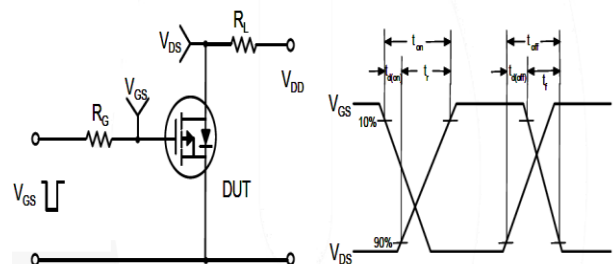
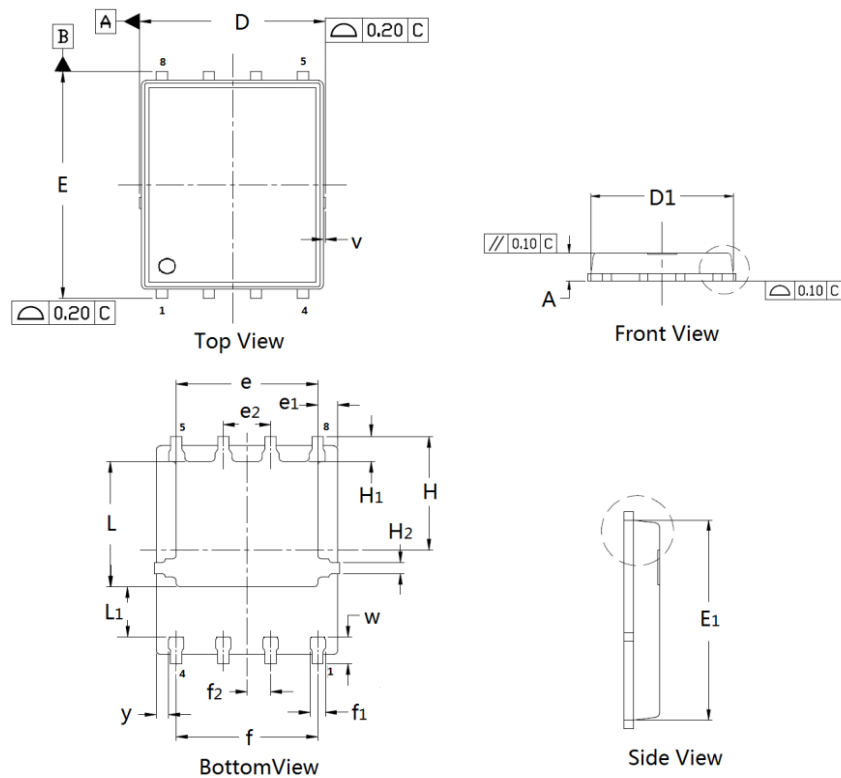

Fig11. Switching Time Test Circuit and waveforms

**PDFN5×6 Package Outline Data**



**DIMENSIONS** ( unit : mm )

Symbol	Min	Typ	Max	Symbol	Min	Typ	Max
A	0.90	1.02	1.10	D	4.90	4.98	5.10
D <sub>1</sub>	4.80	4.89	5.00	E	6.00	6.11	6.20
E <sub>1</sub>	5.65	5.74	5.85	e	3.72	3.80	3.92
e <sub>1</sub>	--	0.54	--	e <sub>2</sub>	--	1.27	--
f	--	3.82	--	f <sub>1</sub>	0.31	0.37	0.51
f <sub>2</sub>	--	0.64	--	H	--	3.15	--
H <sub>1</sub>	0.59	0.63	0.79	H <sub>2</sub>	0.26	0.28	0.32
L	3.38	3.45	3.58	L <sub>1</sub>	--	1.39	--
v	--	0.13	--	w	0.64	0.68	0.84
y	--	0.34	--		--		--

**Customer Service**

**Sales and Service:**

[sales@vgsemi.com](mailto:sales@vgsemi.com)

**Vanguard Semiconductor CO., LTD**

**TEL:** (86-755) -26902410

**FAX:** (86-755) -26907027

**WEB:** [www.vgsemi.com](http://www.vgsemi.com)