

Features

- N-Channel, 5V Logic Level Control
- Enhancement mode
- Very low on-resistance $R_{DS(on)}$ @ $V_{GS}=4.5V$
- 100% Avalanche test
- Pb-free lead plating; RoHS compliant



Part ID	Package Type	Marking	Tape and reel information
VS40200AT	TO-220AB	40200AT	50pcs/Tube

V_{DS}	40	V
$R_{DS(on),TYP} @ V_{GS}=10V$	2.5	m Ω
$R_{DS(on),TYP} @ V_{GS}=4.5V$	3.5	m Ω
I_D	200	A

TO-220AB

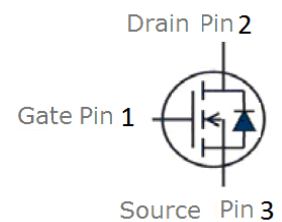
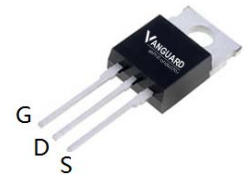

Maximum ratings, at $T_j=25^{\circ}C$, unless otherwise specified

Symbol	Parameter	Rating	Unit
$V_{(BR)DSS}$	Drain-Source breakdown voltage	40	V
I_S	Diode continuous forward current	$T_C=25^{\circ}C$ 200	A
I_D	Continuous drain current @ $V_{GS}=-10V$	$T_C=25^{\circ}C$ 200	A
		$T_C=100^{\circ}C$ 142	A
I_{DM}	Pulse drain current tested ①	$T_C=25^{\circ}C$ 800	A
EAS	Avalanche energy, single pulsed ②	390	mJ
P_D	Maximum power dissipation	$T_C=25^{\circ}C$ 150	W
V_{GS}	Gate-Source voltage	± 20	V
$T_{STG} T_J$	Storage and operating temperature range	-55 to 175	$^{\circ}C$
Thermal Characteristics			
$R_{\theta JC}$	Thermal Resistance-Junction to Case	1.0	$^{\circ}C/W$
$R_{\theta JA}$	Thermal Resistance-Junction to Ambient	62.5	$^{\circ}C/W$

Symbol	Parameter	Condition	Min.	Typ.	Max.	Unit
Static Electrical Characteristics @ $T_j = 25^\circ\text{C}$ (unless otherwise stated)						
$V_{(BR)DSS}$	Drain-Source Breakdown Voltage	$V_{GS}=0V, I_D=250\mu A$	40	--	--	V
I_{DSS}	Zero Gate Voltage Drain Current	$V_{DS}=40V, V_{GS}=0V$	--	--	1	μA
	Zero Gate Voltage Drain Current($T_j=125^\circ\text{C}$)	$V_{DS}=40V, V_{GS}=0V$	--	--	100	μA
I_{GSS}	Gate-Body Leakage Current	$V_{GS}=\pm 20V, V_{DS}=0V$	--	--	± 100	nA
$V_{GS(TH)}$	Gate Threshold Voltage	$V_{DS}=V_{GS}, I_D=250\mu A$	1.2	1.8	2.4	V
$R_{DS(ON)}$	Drain-Source On-State Resistance ^③	$V_{GS}=10V, I_D=60A$	--	2.5	4	m Ω
$R_{DS(ON)}$	Drain-Source On-State Resistance ^③	$V_{GS}=4.5V, I_D=30A$	--	3.5	6	m Ω
Dynamic Electrical Characteristics @ $T_j = 25^\circ\text{C}$ (unless otherwise stated)						
C_{iss}	Input Capacitance	$V_{DS}=20V, V_{GS}=0V,$ $f=1\text{MHz}$	5600	6605	7600	pF
C_{oss}	Output Capacitance		400	550	700	pF
C_{rss}	Reverse Transfer Capacitance		320	440	560	pF
R_g	Gate Resistance	$f=1\text{MHz}$	--	1.9	--	Ω
Q_g	Total Gate Charge	$V_{DS}=20V, I_D=30A,$ $V_{GS}=10V$	--	109	--	nC
Q_{gs}	Gate-Source Charge		--	30.5	--	nC
Q_{gd}	Gate-Drain Charge		--	42	--	nC
Switching Characteristics						
$t_{d(on)}$	Turn-on Delay Time	$V_{DD}=20V,$ $I_D=30A,$ $R_G=3\Omega,$ $V_{GS}=10V$	--	30	--	nS
t_r	Turn-on Rise Time		--	24	--	nS
$t_{d(off)}$	Turn-Off Delay Time		--	45.5	--	nS
t_f	Turn-Off Fall Time		--	16.5	--	nS
Source- Drain Diode Characteristics @ $T_j = 25^\circ\text{C}$ (unless otherwise stated)						
V_{SD}	Forward on voltage	$I_{SD}=30A, V_{GS}=0V$	--	0.9	1.2	V
t_{rr}	Reverse Recovery Time	$T_j=25^\circ\text{C}, I_{sd}=30A,$ $V_{GS}=0V$ $di/dt=500A/\mu s$	--	29	--	nS
Q_{rr}	Reverse Recovery Charge		--	179	--	nC

NOTE:

- ① Repetitive rating; pulse width limited by max. junction temperature.
- ② Limited by T_{jmax} , starting $T_j = 25^\circ\text{C}$, $L = 0.5\text{mH}, R_G = 25\Omega, I_{AS} = 29A, V_{GS} = 10V$. Part not recommended for use above this value
- ③ Pulse width $\leq 300\mu s$; duty cycle $\leq 2\%$.

Typical Characteristics

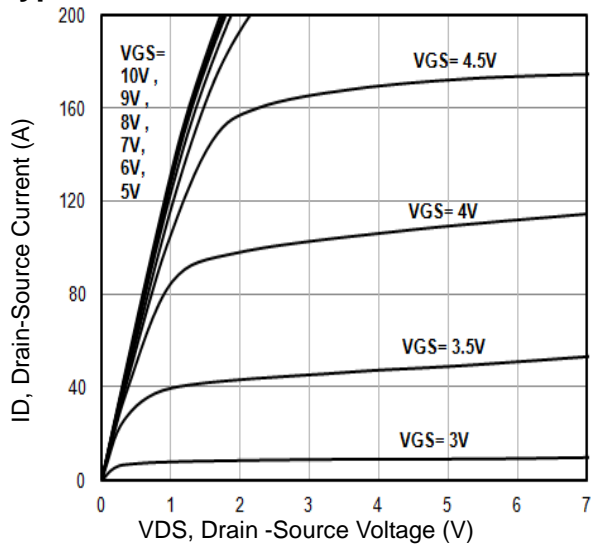

Fig1. Typical Output Characteristics

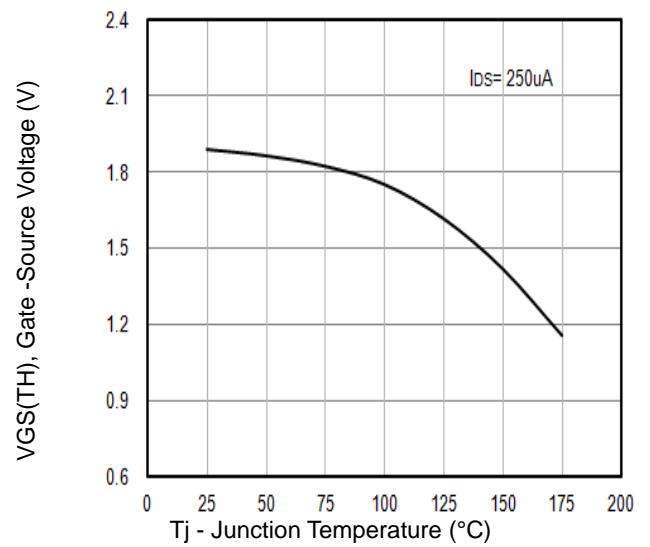

Fig2. $V_{GS(TH)}$ Gate-Source Voltage Vs. T_j

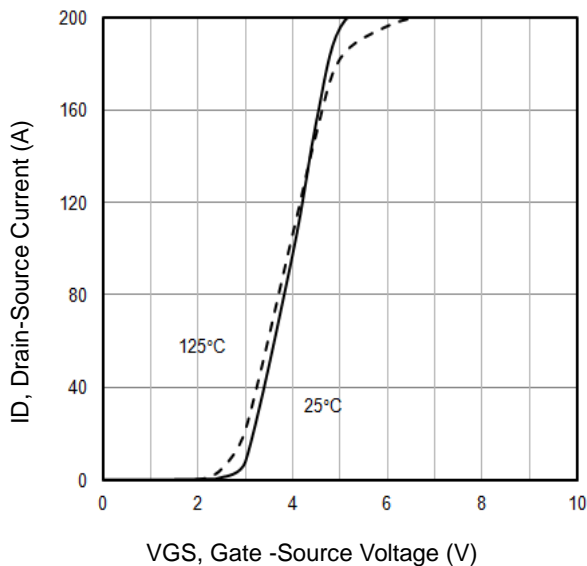

Fig3. Typical Transfer Characteristics

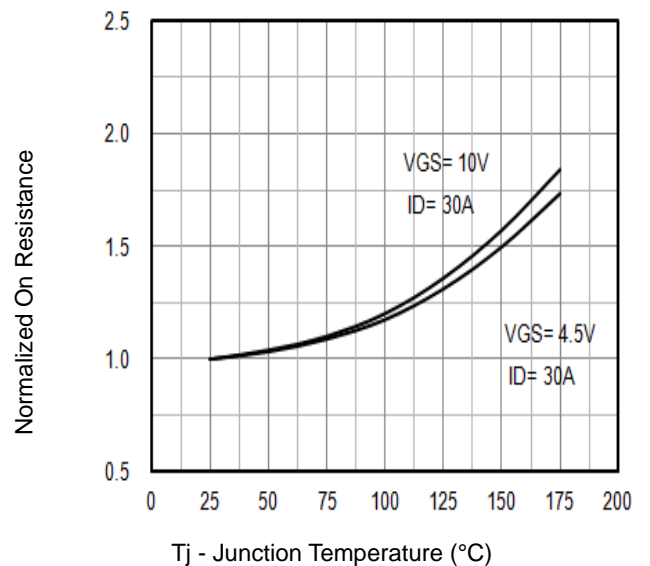

Fig4. Normalized On-Resistance Vs. T_j

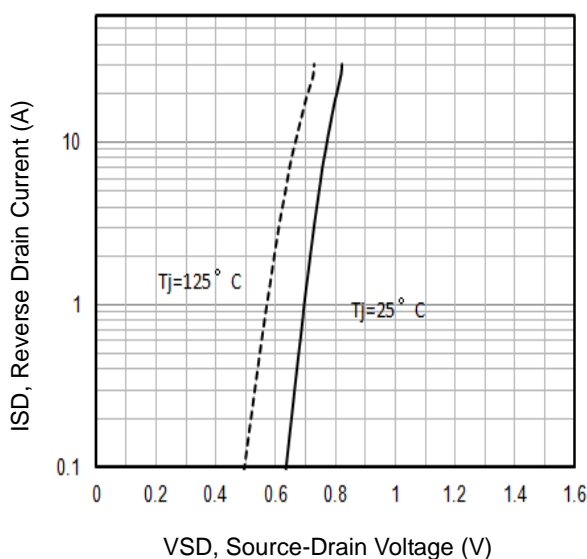

Fig5. Typical Source-Drain Diode Forward Voltage

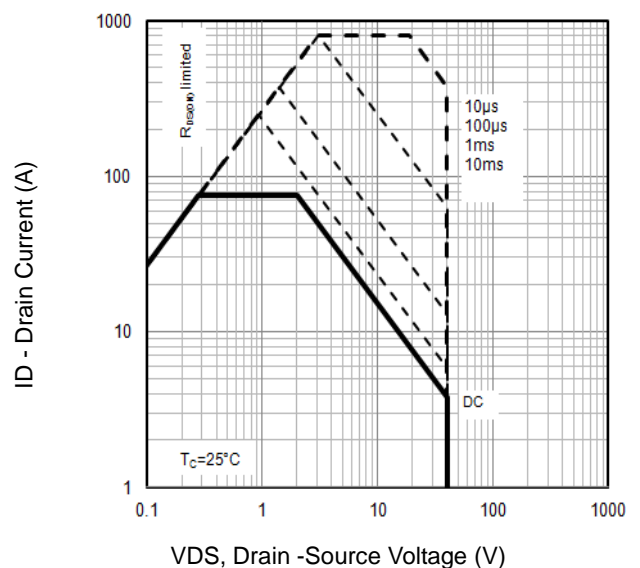

Fig6. Maximum Safe Operating Area

Typical Characteristics

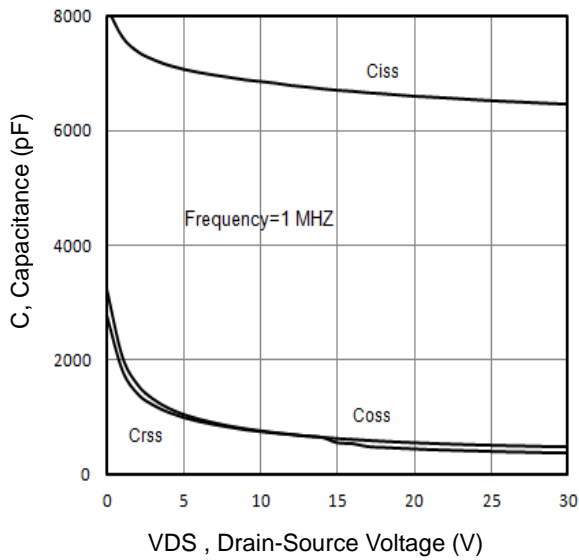

Fig7. Typical Capacitance Vs. Drain-Source Voltage

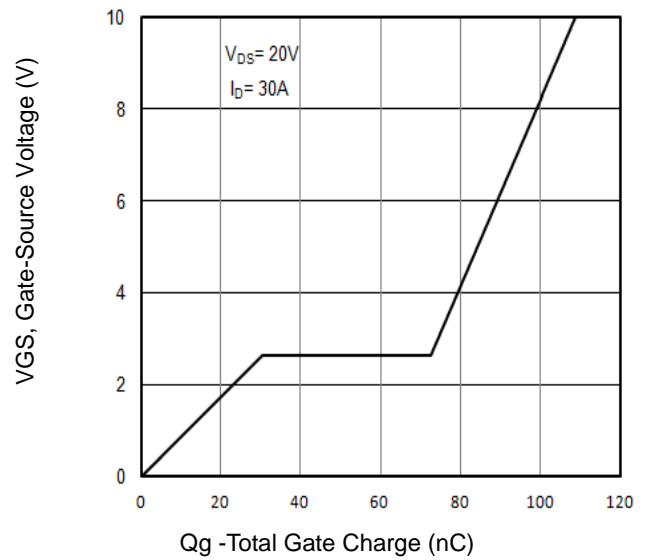

Fig8. Typical Gate Charge Vs. Gate-Source Voltage

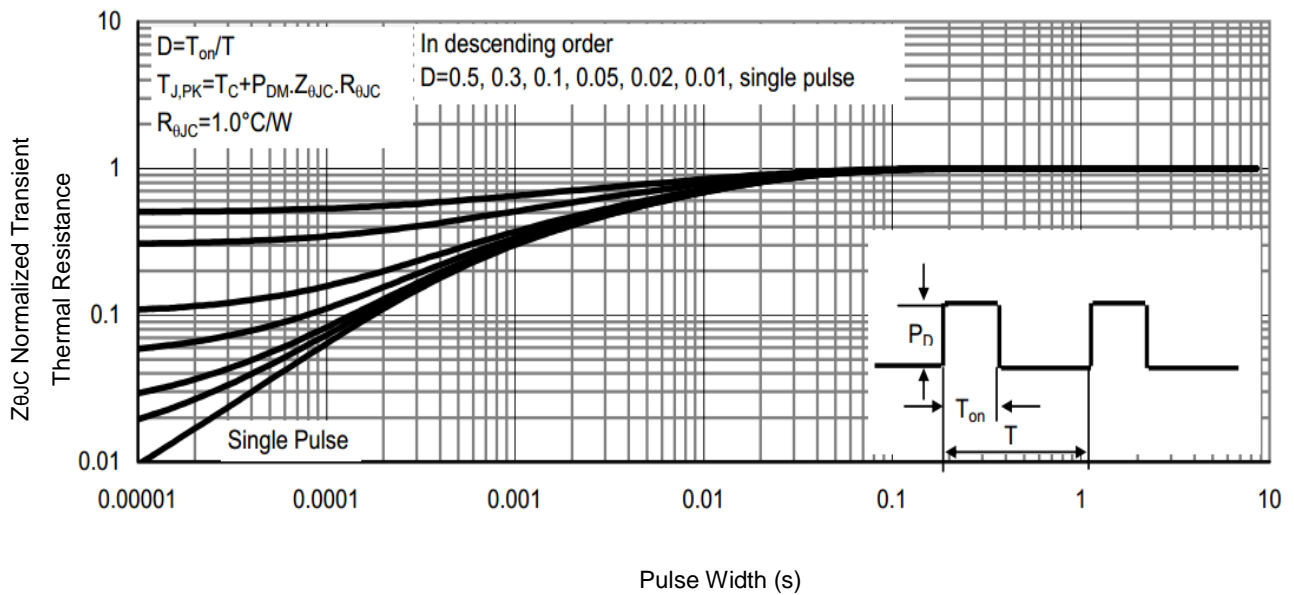

Fig9. Normalized Maximum Transient Thermal Impedance

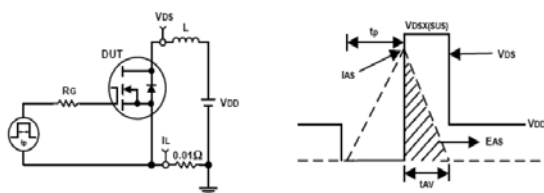

Fig10. Unclamped Inductive Test Circuit and waveforms

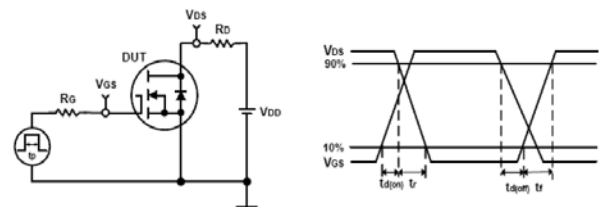
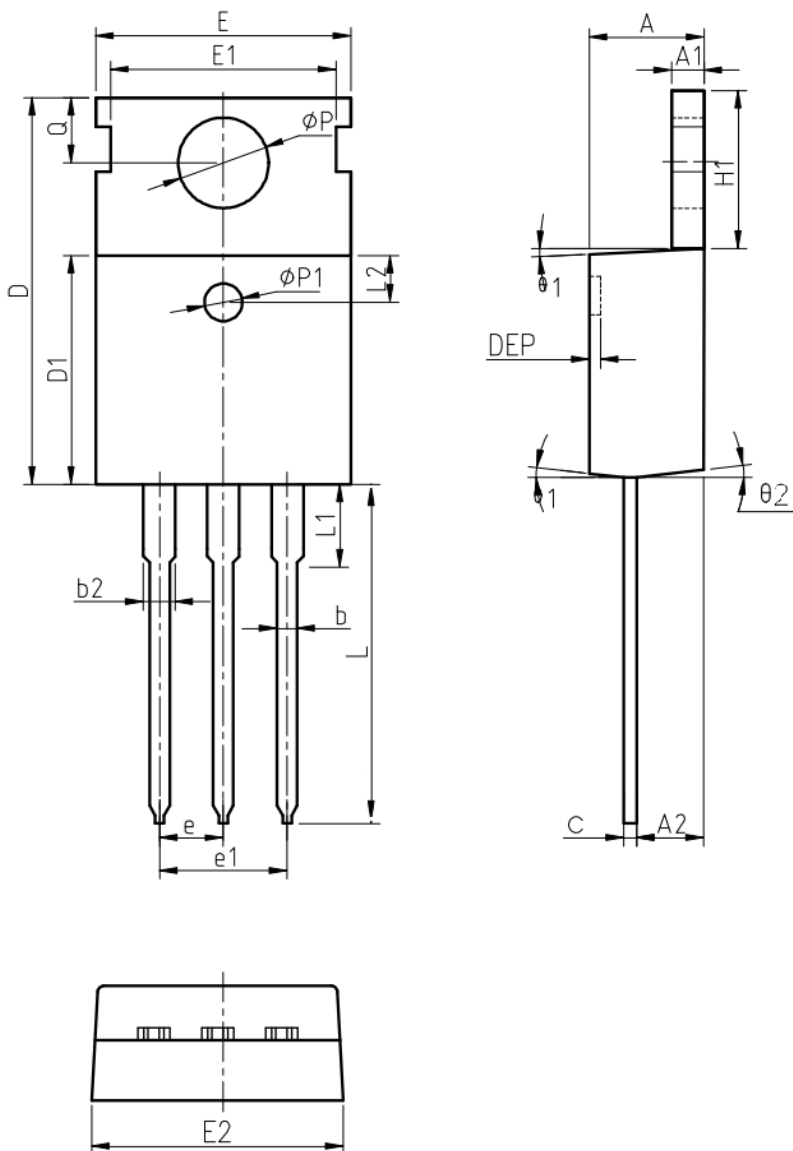

Fig11. Switching Time Test Circuit and waveforms

TO-220AB Package Outline Data



Symbol	Dimensions (unit: mm)		
	Min	Typ	Max
A	4.30	4.52	4.70
A1	1.15	1.30	1.40
A2	2.20	2.40	2.60
b	0.70	0.80	1.00
b2	1.17	1.32	1.50
c	0.45	0.50	0.61
D	15.30	15.65	15.90
D1	9.00	9.20	9.40
DEP	0.05	0.10	0.25
E	9.66	9.90	10.28
E1	-	8.70	-
E2	9.80	10.00	10.20
$\phi P1$	1.40	1.50	1.60
e	2.54 BSC		
e1	5.08 BSC		
H1	6.40	6.50	6.80
L	12.70	-	14.27
L1	-	-	3.95
L2	2.40	2.50	2.60
ϕP	3.53	3.60	3.70
Q	2.70	2.80	2.90
$\theta1$	5 °	7 °	9 °
$\theta2$	1 °	3 °	5 °

Notes:

1. Refer to JEDEC TO-220 variation AB
2. Dimension "D" and "E" do NOT include mold flash. Mold flash shall not exceed 0.127mm per side.

Customer Service

Sales and Service:

sales@vgsemi.com

Vanguard Semiconductor CO., LTD

TEL: (86-755) -26902410

FAX: (86-755) -26907027

WEB: www.vgsemi.com