

## Features

- N-Channel, 5V Logic Level Control
- Enhancement mode
- Low on-resistance  $R_{DS(on)}$  @  $V_{GS}=4.5\text{ V}$
- VitoMOS<sup>®</sup> Technology
- 100% Avalanche test
- Pb-free lead plating; RoHS compliant

**Halogen-Free**

Part ID	Package Type	Marking	Tape and reel information
VS6408AS	SOP8	6408AS	3000PCS/Reel

$V_{DS}$	60	V
$R_{DS(on),TYP} @ V_{GS}=10\text{ V}$	7.8	m $\Omega$
$R_{DS(on),TYP} @ V_{GS}=4.5\text{ V}$	9.3	m $\Omega$
$I_D$	15	A

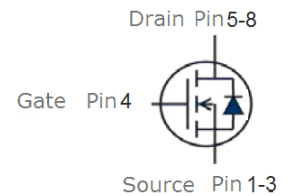

## Maximum ratings, at $T_A = 25^\circ\text{C}$ , unless otherwise specified

Symbol	Parameter	Rating	Unit
$V_{(BR)DSS}$	Drain-Source breakdown voltage	60	V
$I_S$	Diode continuous forward current	$T_A = 25^\circ\text{C}$ 2.6	A
$I_D$	Continuous drain current @ $V_{GS}=10\text{V}$	$T_A = 25^\circ\text{C}$ 15	A
		$T_A = 100^\circ\text{C}$ 10	A
$I_{DM}$	Pulse drain current tested ①	$T_A = 25^\circ\text{C}$ 60	A
EAS	Avalanche energy, single pulsed ②	64	mJ
$P_D$	Maximum power dissipation	$T_A = 25^\circ\text{C}$ 3.1	W
$V_{GS}$	Gate-Source voltage	$\pm 20$	V
MSL		Level 3	
$T_{STG} T_J$	Storage and operating temperature range	-55 to 150	$^\circ\text{C}$

## Thermal Characteristics

Symbol	Parameter	Typical	Unit
$R_{\theta JL}$	Thermal Resistance-Junction to Lead	24	$^\circ\text{C/W}$
$R_{\theta JA}$	Thermal Resistance-Junction to Ambient	40	$^\circ\text{C/W}$

Symbol	Parameter	Condition	Min.	Typ.	Max.	Unit
<b>Static Electrical Characteristics @ T<sub>j</sub>=25°C (unless otherwise stated)</b>						
V <sub>(BR)DSS</sub>	Drain-Source Breakdown Voltage	V <sub>GS</sub> =0V, I <sub>D</sub> =250μA	60	--	--	V
I <sub>DSS</sub>	Zero Gate Voltage Drain Current	V <sub>DS</sub> =60V, V <sub>GS</sub> =0V	--	--	1	μA
	Zero Gate Voltage Drain Current(T <sub>j</sub> =125°C)	V <sub>DS</sub> =60V, V <sub>GS</sub> =0V	--	--	100	μA
I <sub>GSS</sub>	Gate-Body Leakage Current	V <sub>GS</sub> =±20V, V <sub>DS</sub> =0V	--	--	±100	nA
V <sub>GS(TH)</sub>	Gate Threshold Voltage	V <sub>DS</sub> =V <sub>GS</sub> , I <sub>D</sub> =250μA	1.3	1.9	2.4	V
R <sub>DS(ON)</sub>	Drain-Source On-State Resistance <sup>③</sup>	V <sub>GS</sub> =10V, I <sub>D</sub> =10A	--	7.8	10	mΩ
R <sub>DS(ON)</sub>	Drain-Source On-State Resistance <sup>③</sup>	V <sub>GS</sub> =4.5V, I <sub>D</sub> =6A	--	9.3	12	mΩ
<b>Dynamic Electrical Characteristics @ T<sub>j</sub> = 25°C (unless otherwise stated)</b>						
C <sub>iss</sub>	Input Capacitance	V <sub>DS</sub> =30V, V <sub>GS</sub> =0V, f=1MHz	2550	2820	3100	pF
C <sub>oss</sub>	Output Capacitance		145	195	245	pF
C <sub>rss</sub>	Reverse Transfer Capacitance		105	155	205	pF
R <sub>g</sub>	Gate Resistance	f=1MHz	--	3.8	--	Ω
Q <sub>g</sub>	Total Gate Charge	V <sub>DS</sub> =30V, I <sub>D</sub> =10A, V <sub>GS</sub> =10V	--	47	--	nC
Q <sub>gs</sub>	Gate-Source Charge		--	19	--	nC
Q <sub>gd</sub>	Gate-Drain Charge		--	17	--	nC
<b>Switching Characteristics</b>						
t <sub>d(on)</sub>	Turn-on Delay Time	V <sub>DD</sub> =30V, I <sub>D</sub> =10A, R <sub>G</sub> =3.0Ω, V <sub>GS</sub> =10V	--	21	--	nS
t <sub>r</sub>	Turn-on Rise Time		--	18	--	nS
t <sub>d(off)</sub>	Turn-Off Delay Time		--	29	--	nS
t <sub>f</sub>	Turn-Off Fall Time		--	12	--	nS
<b>Source- Drain Diode Characteristics @ T<sub>j</sub> = 25°C (unless otherwise stated)</b>						
V <sub>SD</sub>	Forward on voltage	I <sub>SD</sub> =10A, V <sub>GS</sub> =0V	--	0.8	1.2	V
t <sub>rr</sub>	Reverse Recovery Time	T <sub>j</sub> =25°C, I <sub>sd</sub> =10A, V <sub>GS</sub> =0V di/dt=500A/μs	--	24	--	nS
Q <sub>rr</sub>	Reverse Recovery Charge		98	--	--	nC

**NOTE:**

- ① Repetitive rating; pulse width limited by max. junction temperature.
- ② Limited by T<sub>jmax</sub>, starting T<sub>j</sub> = 25°C, L = 0.5mH, R<sub>G</sub> = 25Ω, I<sub>AS</sub> = 16A, V<sub>GS</sub> = 10V. Part not recommended for use above this value
- ③ Pulse width ≤ 300μs; duty cycle ≤ 2%.

### Typical Characteristics

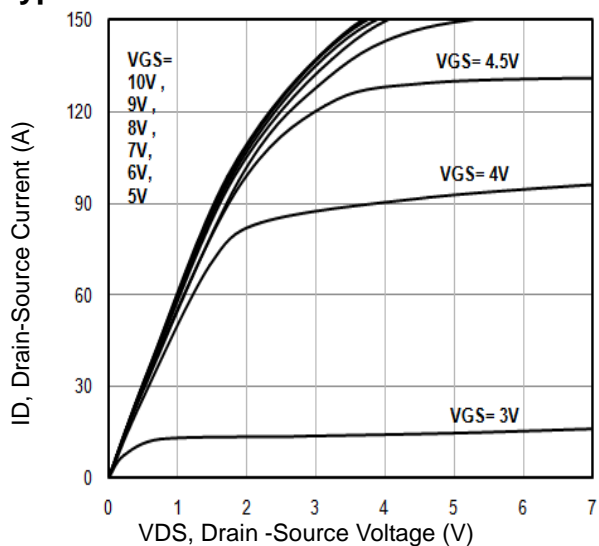

Fig1. Typical Output Characteristics

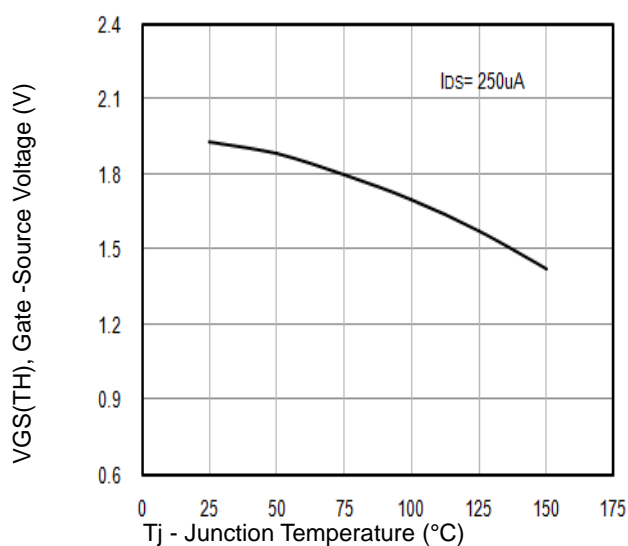

Fig2.  $V_{GS(TH)}$  Gate-Source Voltage Vs.  $T_j$

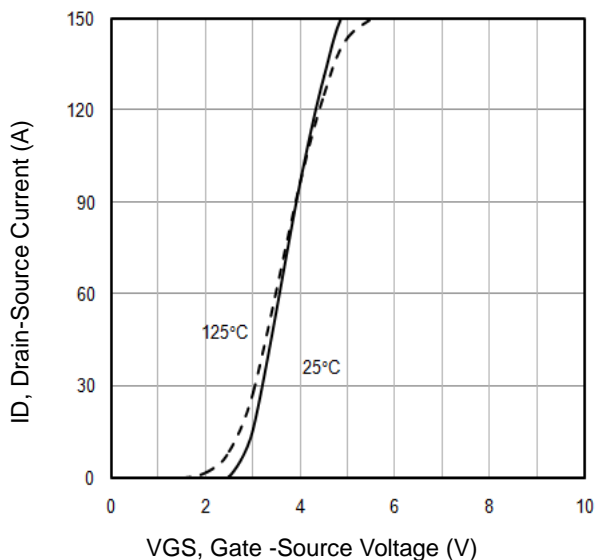

Fig3. Typical Transfer Characteristics

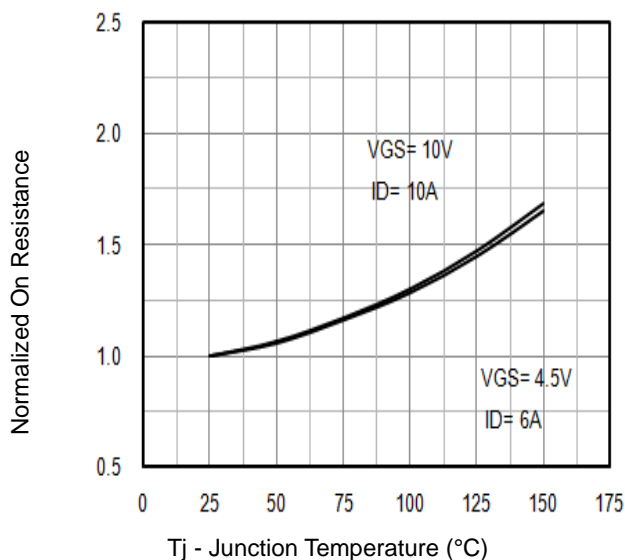

Fig4. Normalized On-Resistance Vs.  $T_j$

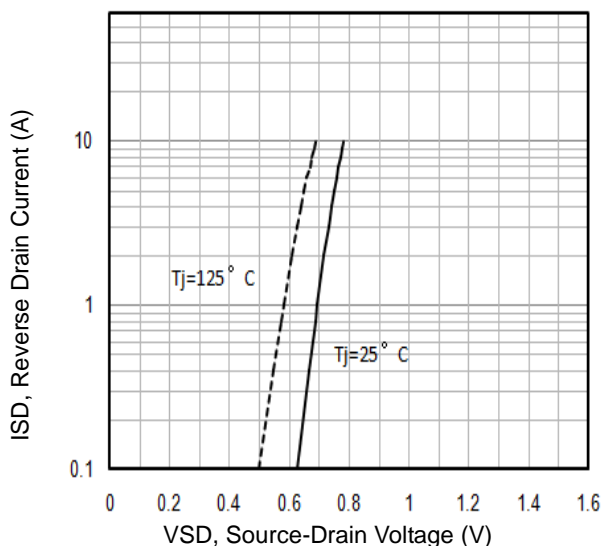

Fig5. Typical Source-Drain Diode Forward Voltage

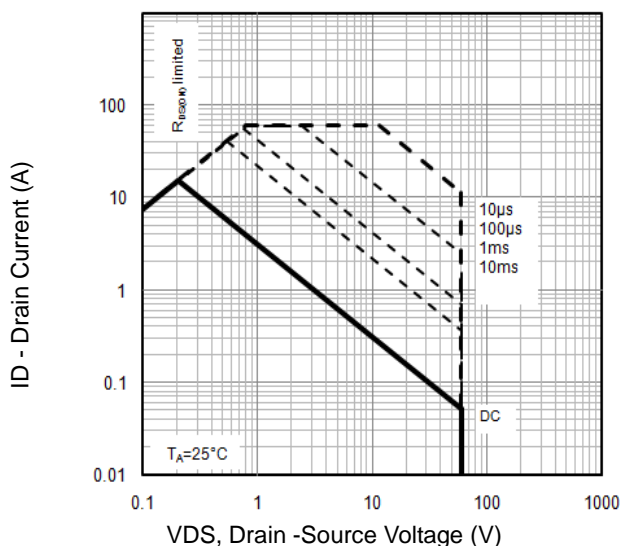

Fig6. Maximum Safe Operating Area

Typical Characteristics

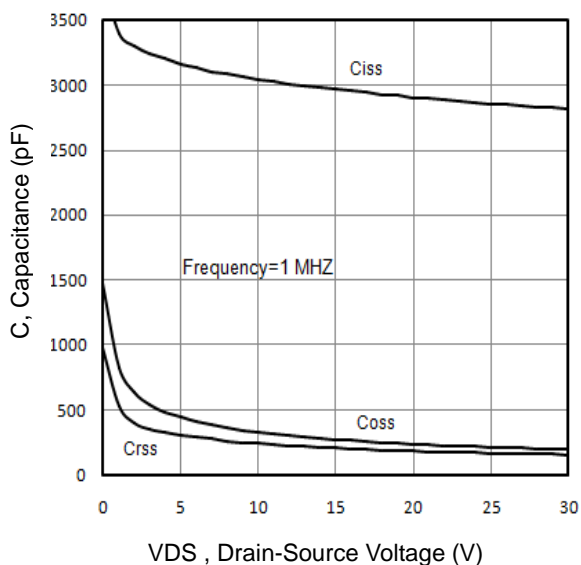

Fig7. Typical Capacitance Vs.Drain-Source Voltage

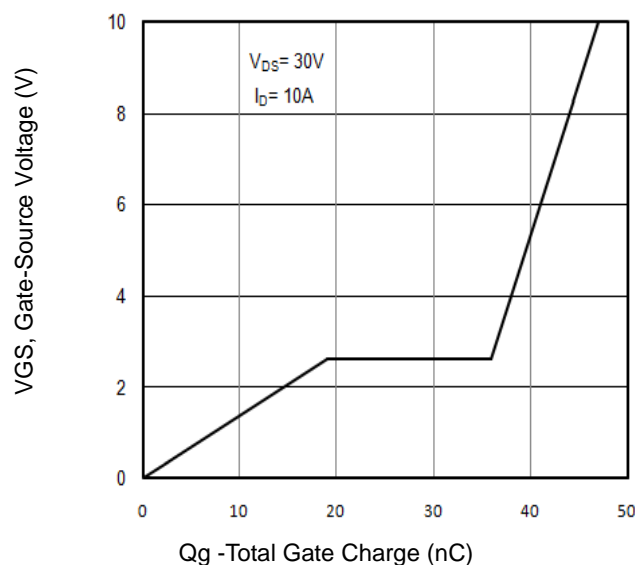

Fig8. Typical Gate Charge Vs.Gate-Source Voltage

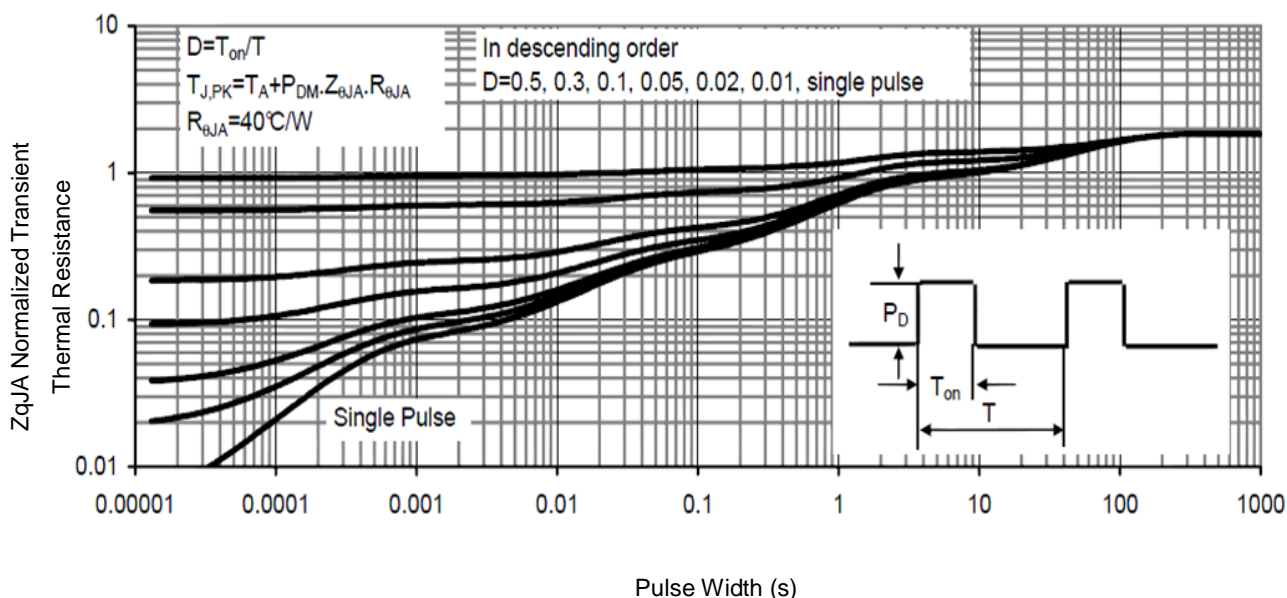

Fig9. Normalized Maximum Transient Thermal Impedance

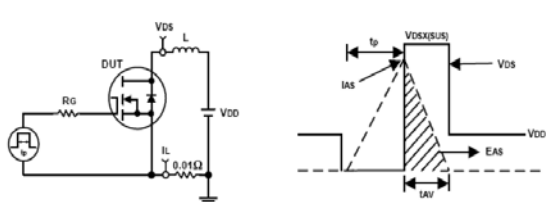

Fig10. Unclamped Inductive Test Circuit and waveforms

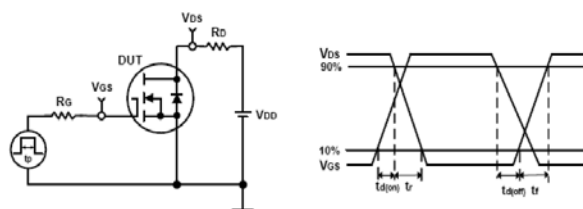
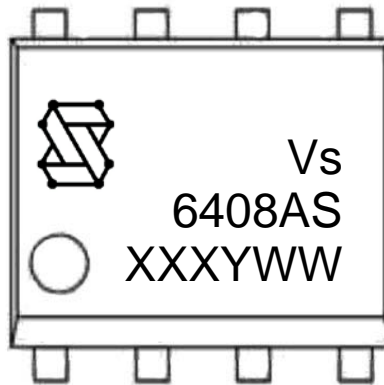

Fig11. Switching Time Test Circuit and waveforms

## Marking Information



1<sup>st</sup> line: Company Code (Vs), Company Logo

2<sup>nd</sup> line: Part Number (6408AS)

3<sup>rd</sup> line: Date code (XXXYWW)

XXX: Wafer Lot Number

Y: Year Code, e.g. E means 2017

WW: Week Code

## SOP8 Package Outline Data

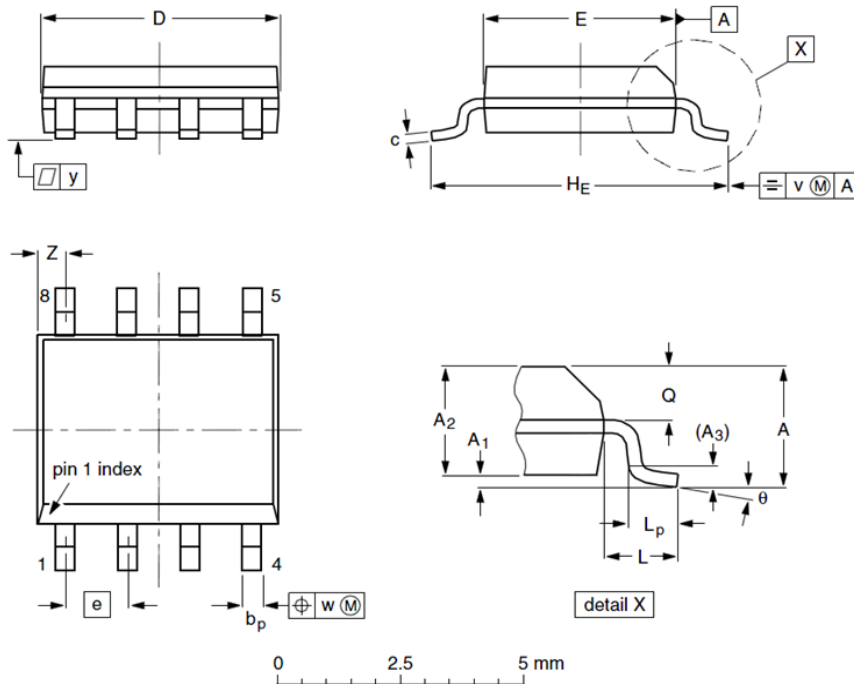

Label	Dimensions (unit: mm)		
	Min	Typ	Max
A	--	--	1.75
A <sub>1</sub>	0.10	0.18	0.25
A <sub>2</sub>	1.25	1.35	1.50
A <sub>3</sub>	--	0.25	--
b <sub>p</sub>	0.36	0.42	0.51
c	0.19	0.22	0.25
D	4.80	4.92	5.00
E	3.80	3.90	4.00
e	--	1.27	--
H <sub>E</sub>	5.80	6.00	6.20
L	--	1.05	--
L <sub>p</sub>	0.40	0.68	1.00
Q	0.60	0.65	0.725
v	--	0.25	--
w	--	0.25	--
y	--	0.10	--
Z	0.30	0.50	0.70
θ	0°		8°

### Notes:

1. Follow JEDEC MS-012.
2. Dimension "D" does NOT include mold flash, protrusions or gate burrs. Mold flash, protrusions or gate burrs shall not exceed 0.15mm per side.
3. Dimension "E" does NOT include interlead flash or protrusion. Interlead flash or protrusion shall not exceed 0.25mm per side.
4. Dimension "bp" does NOT include dambar protrusion. Allowable dambar protrusion shall be 0.1mm total in excess of "bp" dimension at maximum material condition. The dambar cannot be located on the lower radius of the foot.

## Customer Service

### Sales and Service:

[sales@vgsemi.com](mailto:sales@vgsemi.com)

Vanguard Semiconductor CO., LTD

TEL: (86-755) -26902410

FAX: (86-755) -26907027

WEB: [www.vgsemi.com](http://www.vgsemi.com)