

Features

- N-Channel
- Enhancement mode
- Very low on-resistance $R_{DS(on)}$ @ $V_{GS}=4.5V$
- Fast Switching
- 100% Avalanche Tested
- Pb-free lead plating; RoHS compliant



Part ID	Package Type	Marking	Tape and reel information
VSB012N03MS	TDFN3.3x3.3	012N03M	5000pcs/Reel

V_{DS}	30	V
$R_{DS(on),TYP} @ V_{GS}=10V$	9	m Ω
$R_{DS(on),TYP} @ V_{GS}=4.5V$	12	m Ω
I_D	38	A

TDFN3.3x3.3

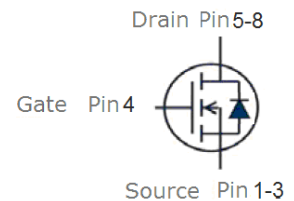
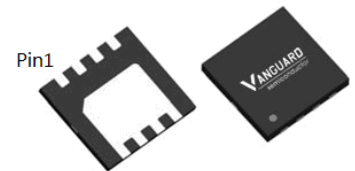

Maximum ratings, at $T_j=25^\circ\text{C}$, unless otherwise specified

Symbol	Parameter	Rating	Unit
$V_{(BR)DSS}$	Drain-Source breakdown voltage	30	V
I_S	Diode continuous forward current	$T_C=25^\circ\text{C}$ 38	A
I_D	Continuous drain current @ $V_{GS}=10V$	$T_C=25^\circ\text{C}$ 38	A
		$T_A=100^\circ\text{C}$ 24	A
I_{DM}	Pulse drain current tested ①	$T_C=25^\circ\text{C}$ 150	A
EAS	Avalanche energy, single pulsed ②	$I_D=20A$ 48	mJ
IAS	Avalanche energy, single pulsed ②	30	A
P_D	Maximum power dissipation	$T_A=25^\circ\text{C}$ 41	W
V_{GS}	Gate-Source voltage	± 20	V
$T_{STG} T_J$	Storage and operating temperature range	-55 to 150	$^\circ\text{C}$

Thermal Characteristics

Symbol	Parameter	Typical	Unit
$R_{\theta JC}$	Thermal Resistance-Junction to Case	3	$^\circ\text{C/W}$
$R_{\theta JA}$	Thermal Resistance Junction-Ambient	45	$^\circ\text{C/W}$

Typical Characteristics

Symbol	Parameter	Condition	Min.	Typ.	Max.	Unit
Static Electrical Characteristics @ T_c = 25°C (unless otherwise stated)						
V _{(BR)DSS}	Drain-Source Breakdown Voltage	V _{GS} =0V, I _D =250μA	30	--	--	V
I _{DSS}	Zero Gate Voltage Drain Current(T _c =25°C)	V _{DS} =24V, V _{GS} =0V	--	--	1	μA
	Zero Gate Voltage Drain Current(T _c =125°C)	V _{DS} =24V, V _{GS} =0V	--	--	100	μA
I _{GSS}	Gate-Body Leakage Current	V _{GS} =±20V, V _{DS} =0V	--	--	±100	nA
V _{GS(TH)}	Gate Threshold Voltage	V _{DS} =V _{GS} , I _D =250μA	0.8	1.5	2.2	V
R _{DS(ON)}	Drain-Source On-State Resistance ^③	V _{GS} =10V, I _D =25A	--	9	12	mΩ
R _{DS(ON)}	Drain-Source On-State Resistance ^③	V _{GS} =4.5V, I _D =10A	--	12	16	mΩ
Dynamic Electrical Characteristics @ T_c = 25°C (unless otherwise stated)						
C _{iss}	Input Capacitance	V _{DS} =15V, V _{GS} =0V, f=1MHz	--	980	--	pF
C _{oss}	Output Capacitance		--	160	--	pF
C _{rss}	Reverse Transfer Capacitance		--	115	--	pF
Q _g	Total Gate Charge	V _{DS} =15V, I _D =20A, V _{GS} =10V	--	18	--	nC
Q _{gs}	Gate-Source Charge		--	4.5	--	nC
Q _{gd}	Gate-Drain Charge		--	5.5	--	nC
Switching Characteristics						
t _{d(on)}	Turn-on Delay Time	V _{DD} =15V, I _D =10A, R _G =6.8Ω, V _{GS} =10V	--	7	--	nS
t _r	Turn-on Rise Time		--	14	--	nS
t _{d(off)}	Turn-Off Delay Time		--	22	--	nS
t _f	Turn-Off Fall Time		--	8	--	nS
Source- Drain Diode Characteristics @ T_c = 25°C (unless otherwise stated)						
V _{SD}	Forward on voltage	I _{SD} =2A, V _{GS} =0V	--	0.74	1.2	V
t _{rr}	Reverse Recovery Time	T _j =25°C, I _{sd} =10A, V _{GS} =0V	--	21	--	nS
Q _{rr}	Reverse Recovery Charge		di/dt=100A/μs		11	

NOTE:

- ① Repetitive rating; pulse width limited by max. junction temperature.
- ② Limited by T_{Jmax}, starting T_J = 25°C, L = 0.3mH, R_G = 25Ω, I_{AS} = 18A, V_{GS} = 10V. Part not recommended for use above this value
- ③ Pulse width ≤ 300μs; duty cycle ≤ 2%.

Typical Characteristics

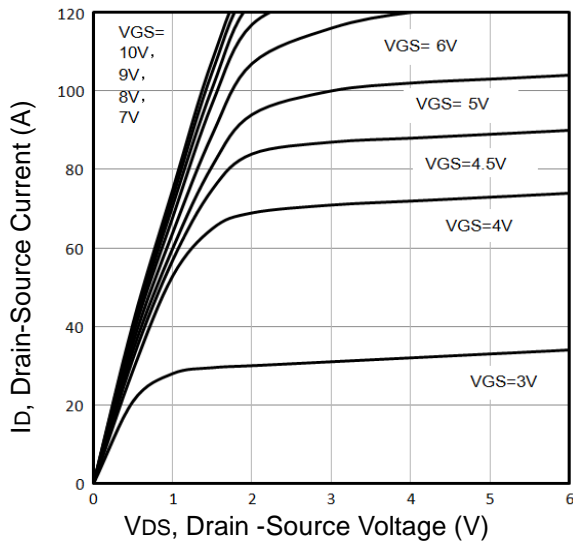

Fig1. Typical Output Characteristics

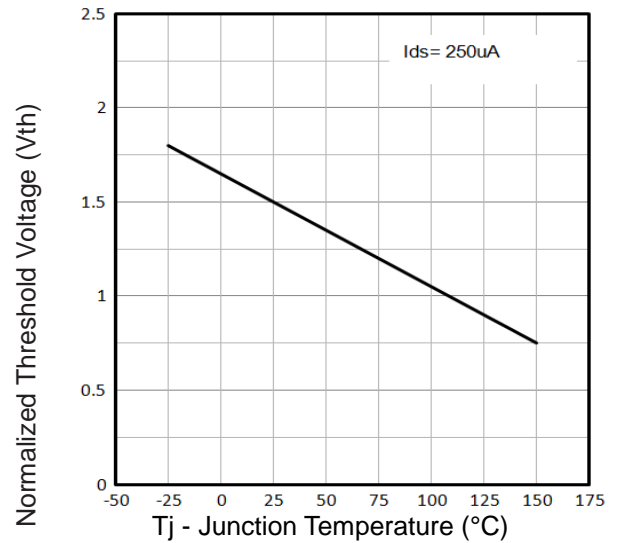

Fig2. Normalized Threshold Voltage Vs. Temperature

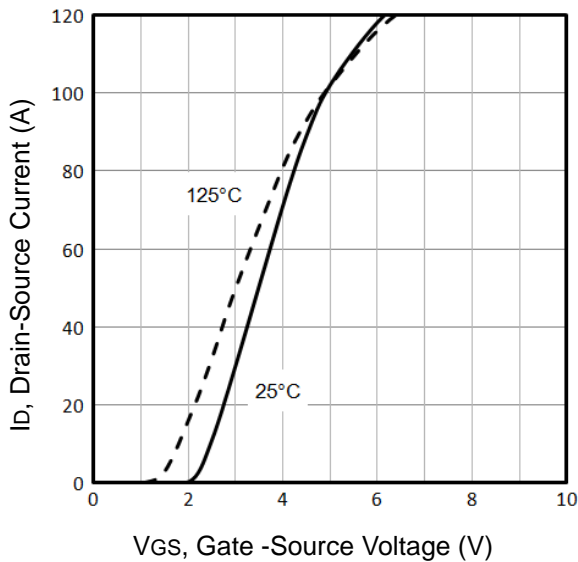

Fig3. Typical Transfer Characteristics

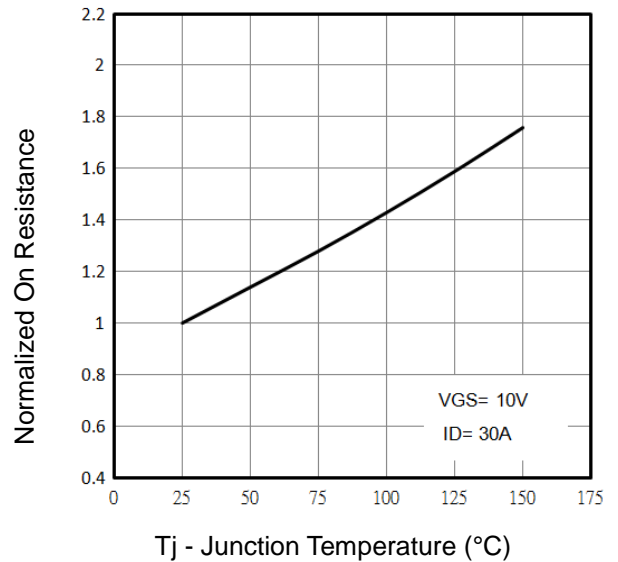

Fig4. Normalized On-Resistance Vs. Temperature

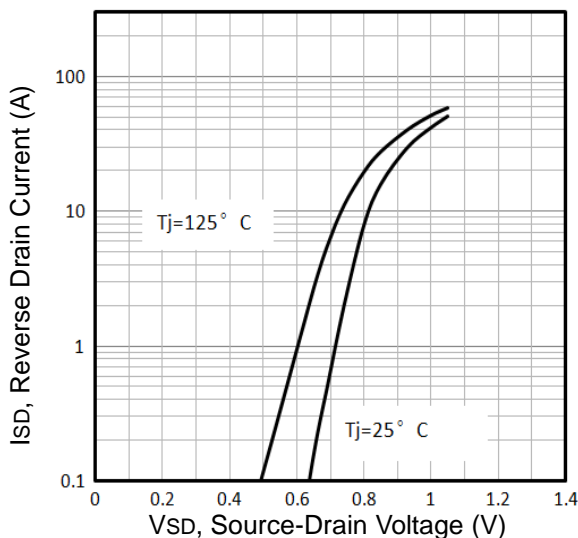

Fig5. Typical Source-Drain Diode Forward Voltage

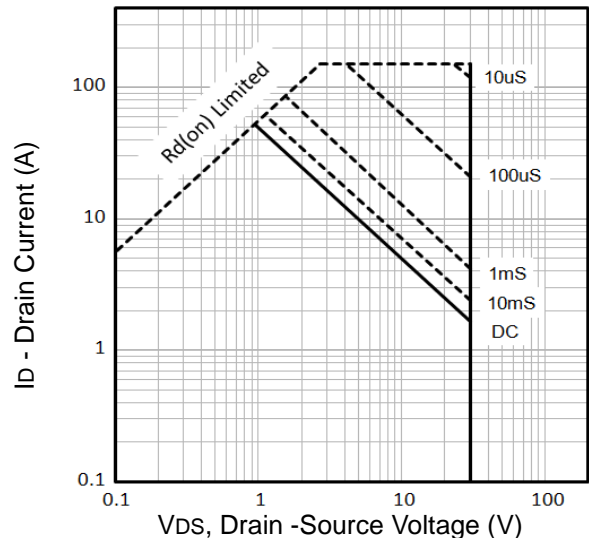

Fig6. Maximum Safe Operating Area

Typical Characteristics

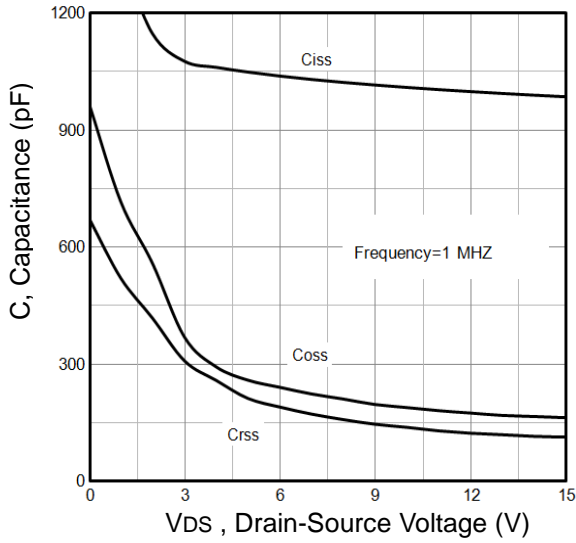

Fig7. Typical Capacitance Vs.Drain-Source Voltage

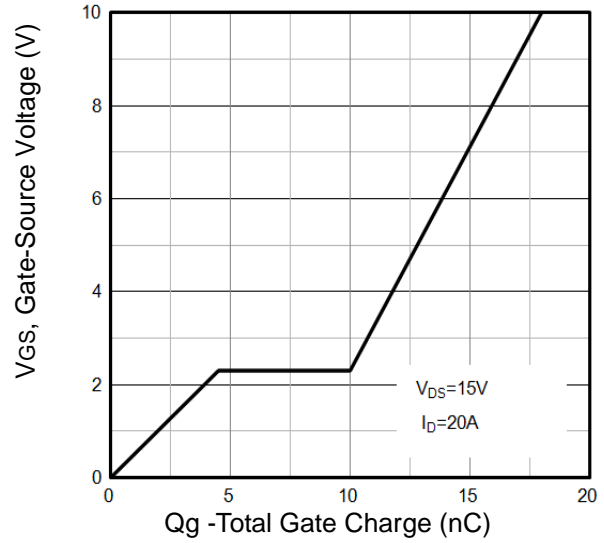

Fig8. Typical Gate Charge Vs.Gate-Source

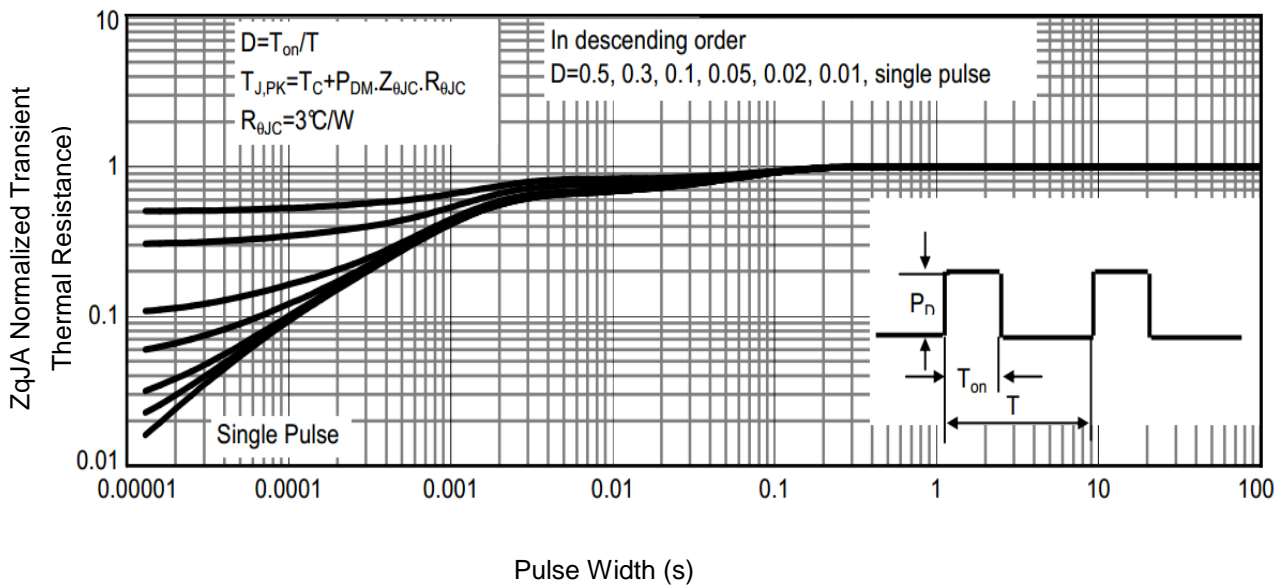

Fig 9 . Normalized Maximum Transient Thermal Impedance

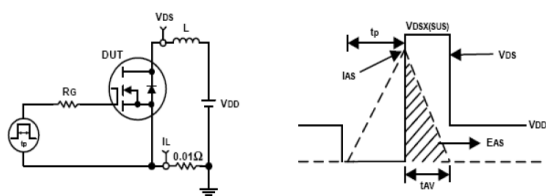

Fig10. Unclamped Inductive Test Circuit and waveforms

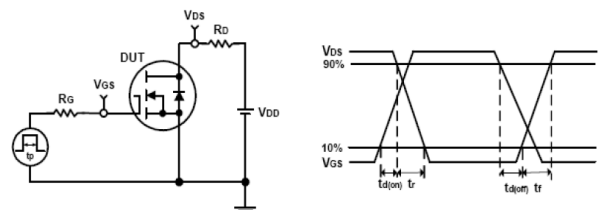
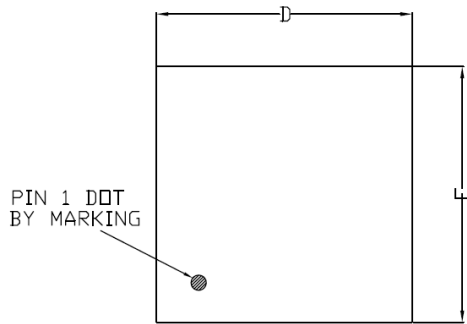
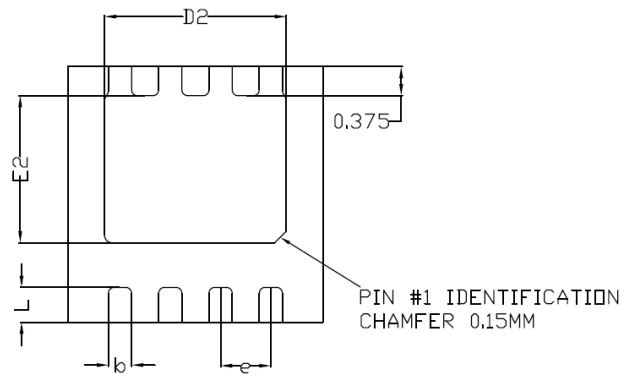

Fig11. Switching Time Test Circuit and waveforms

TDFN3.3x3.3 Package Outline Data



TOP VIEW



BOTTOM VIEW

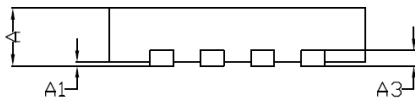

SIDE VIEW

Lead finish : NiPdAu

DIMENSIONS (unit : mm)

Symbol	Min	Typ	Max	Symbol	Min	Typ	Max
A	0.70	0.75	0.80	A1	0.00	--	0.05
A3	0.20 REF			D	3.25	3.30	3.35
E	3.25	3.30	3.35	D2	2.30	2.35	2.40
E2	1.85	1.90	1.95	b	0.25	0.30	0.35
L	0.35	0.45	0.55	e	0.65 BSC		

Customer Service

Sales and Service:

Sales@vgsemi.com

Vanguard Semiconductor CO., LTD

TEL: (86-755) -26902410

FAX: (86-755) -26907027

WEB: www.vgsemi.com