

Features

- N-Channel
- Enhancement mode
- Very low on-resistance $R_{DS(on)}$ @ $V_{GS}=4.5\text{ V}$
- Fast Switching
- 100% Avalanche test
- Pb-free lead plating; RoHS compliant



Part ID	Package Type	Marking	Tape and reel information
VSD013N10MS	TO-252	013N10M	3000PCS/Reel

V_{DS}	100	V
$R_{DS(on),TYP}@ V_{GS}=10\text{ V}$	11	m Ω
$R_{DS(on),TYP}@ V_{GS}=4.5\text{ V}$	12	m Ω
I_D	52	A

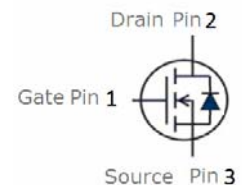
TO-252

Maximum ratings, at $T_j=25^\circ\text{C}$, unless otherwise specified

Symbol	Parameter	Rating	Unit
$V_{(BR)DSS}$	Drain-Source breakdown voltage	100	V
I_S	Diode continuous forward current	$T_C=25^\circ\text{C}$	52 A
I_D	Continuous drain current @ $V_{GS}=10\text{V}$	$T_C=25^\circ\text{C}$	52 A
		$T_A=100^\circ\text{C}$	33 A
I_{DM}	Pulse drain current tested ①	$T_C=25^\circ\text{C}$	150 A
EAS	Avalanche energy, single pulsed ②	$I_D=18\text{A}$	60 mJ
IAS	Avalanche energy, single pulsed ②		20 A
P_D	Maximum power dissipation	$T_A=25^\circ\text{C}$	78 W
V_{GS}	Gate-Source voltage	± 20	V
$T_{STG} T_J$	Storage and operating temperature range	-55 to 175	$^\circ\text{C}$

Thermal Characteristics

Symbol	Parameter	Typical	Unit
$R_{\theta JC}$	Thermal Resistance-Junction to Case	1.9	$^\circ\text{C/W}$
$R_{\theta JA}$	Thermal Resistance Junction-Ambient	60	$^\circ\text{C/W}$

Symbol	Parameter	Condition	Min.	Typ.	Max.	Unit
Static Electrical Characteristics @ T_c = 25°C (unless otherwise stated)						
V _{(BR)DSS}	Drain-Source Breakdown Voltage	V _{GS} =0V I _D =250μA	100	--	--	V
I _{DSS}	Zero Gate Voltage Drain Current(T _c =25°C)	V _{DS} =100V, V _{GS} =0V	--	--	1	μA
	Zero Gate Voltage Drain Current(T _c =125°C)	V _{DS} =100V, V _{GS} =0V	--	--	100	μA
I _{GSS}	Gate-Body Leakage Current	V _{GS} =±20V, V _{DS} =0V	--	--	±100	nA
V _{GS(TH)}	Gate Threshold Voltage	V _{DS} =V _{GS} , I _D =250μA	1.0	2.0	3.0	V
R _{DS(ON)}	Drain-Source On-State Resistance ^③	V _{GS} =10V, I _D =25A	--	11	13	mΩ
R _{DS(ON)}	Drain-Source On-State Resistance ^③	V _{GS} =4.5V, I _D =5A	--	12	15	mΩ
Dynamic Electrical Characteristics @ T_c = 25°C (unless otherwise stated)						
C _{iss}	Input Capacitance	V _{DS} =20V, V _{GS} =0V, f=1MHz	--	3625	--	pF
C _{oss}	Output Capacitance		--	225	--	pF
C _{rss}	Reverse Transfer Capacitance		--	140	--	pF
Q _g	Total Gate Charge	V _{DS} =50V, I _D =4A, V _{GS} =10V	--	83	--	nC
Q _{gs}	Gate-Source Charge		--	12	--	nC
Q _{gd}	Gate-Drain Charge		--	16.5	--	nC
Switching Characteristics						
t _{d(on)}	Turn-on Delay Time	V _{DD} =50V, I _D =4A, R _G =6.8Ω, V _{GS} =10V	--	23	--	nS
t _r	Turn-on Rise Time		--	112	--	nS
t _{d(off)}	Turn-Off Delay Time		--	50	--	nS
t _f	Turn-Off Fall Time		--	100	--	nS
Source- Drain Diode Characteristics @ T_c = 25°C (unless otherwise stated)						
V _{SD}	Forward on voltage	I _{SD} =25A, V _{GS} =0V	--	0.83	1.20	V
t _{rr}	Reverse Recovery Time	T _j =25°C, I _{sd} =4A, V _{GS} =0V di/dt=100A/μs	--	33	--	nS
Q _{rr}	Reverse Recovery Charge		42			nC

NOTE:

- ① Repetitive rating; pulse width limited by max. junction temperature.
- ② Limited by T_{jmax}, starting T_J = 25°C, L = 0.3mH, R_G = 25Ω, I_{AS} = 20A, V_{GS} = 10V. Part not recommended for use above this value
- ③ Pulse width ≤ 300μs; duty cycle ≤ 2%.

Typical Characteristics

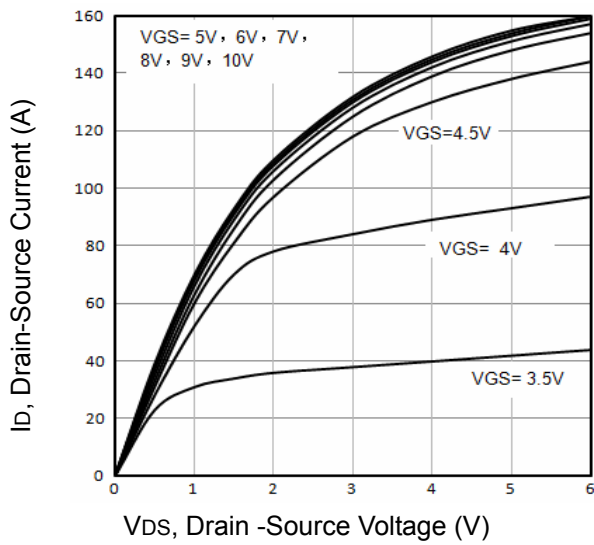

Fig1. Typical Output Characteristics

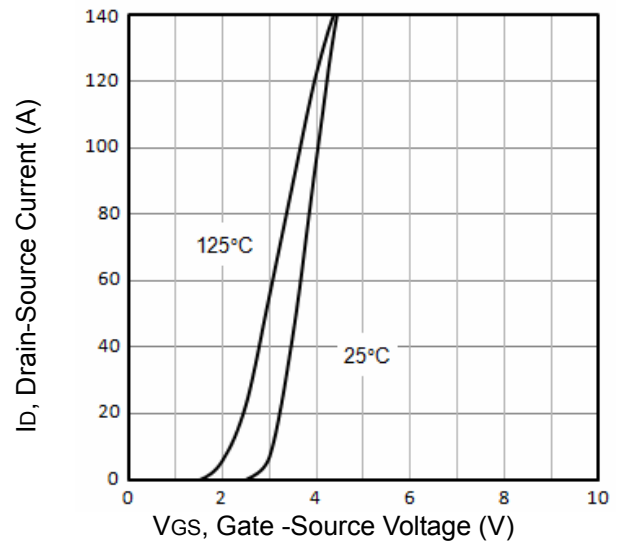

Fig2. Typical Transfer Characteristics

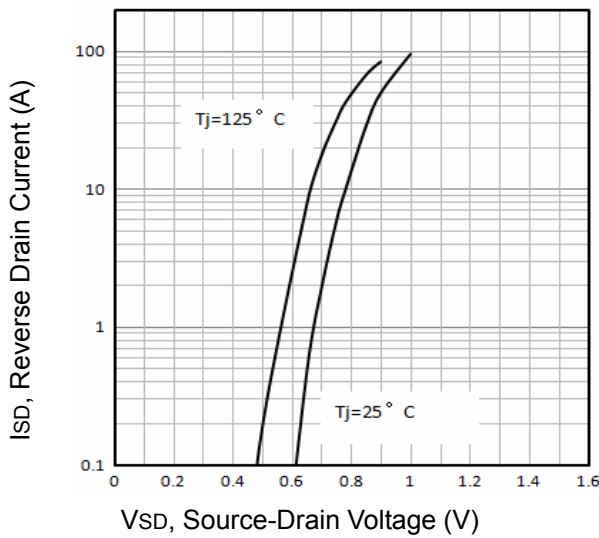

Fig3. Typical Source-Drain Diode Forward

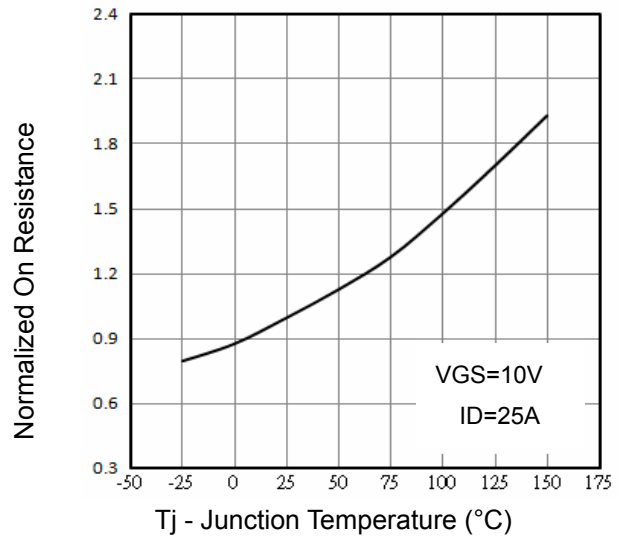

Fig4. Normalized On-Resistance Vs. Temperature

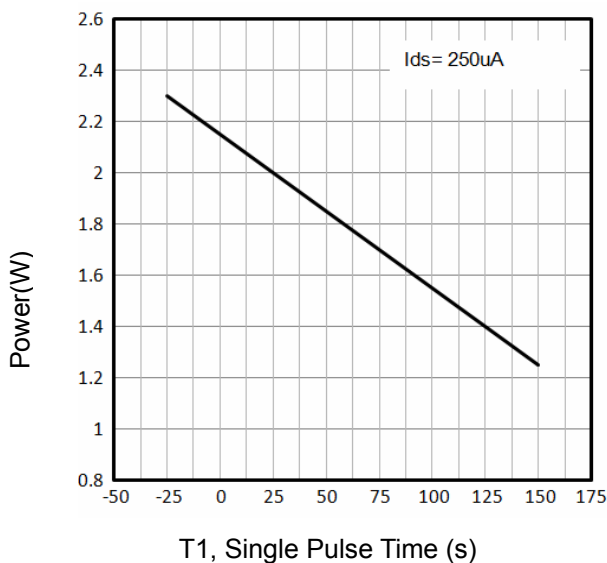

Fig5. Single Pulse Maximum Power Dissipation

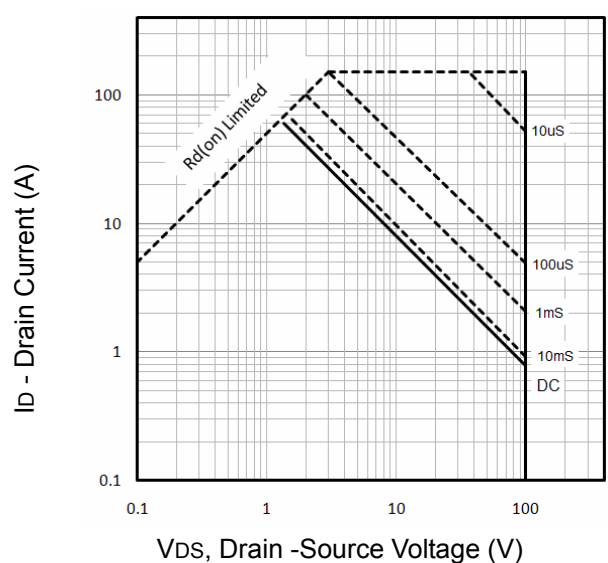

Fig6. Maximum Safe Operating Area

Typical Characteristics

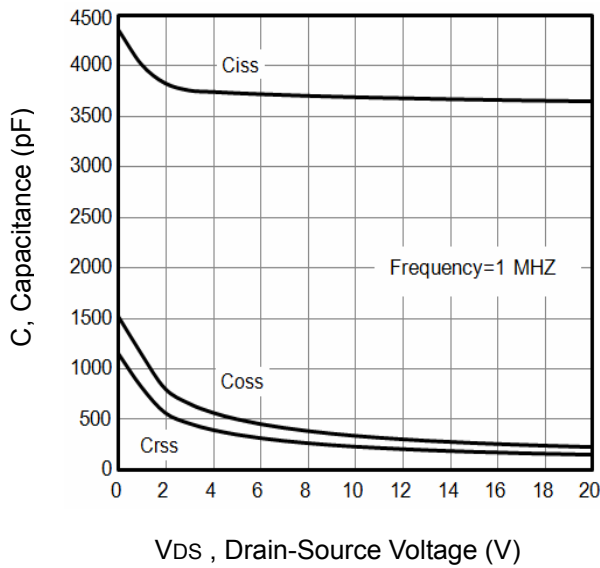

Fig7. Typical Capacitance Vs.Drain-Source Voltage

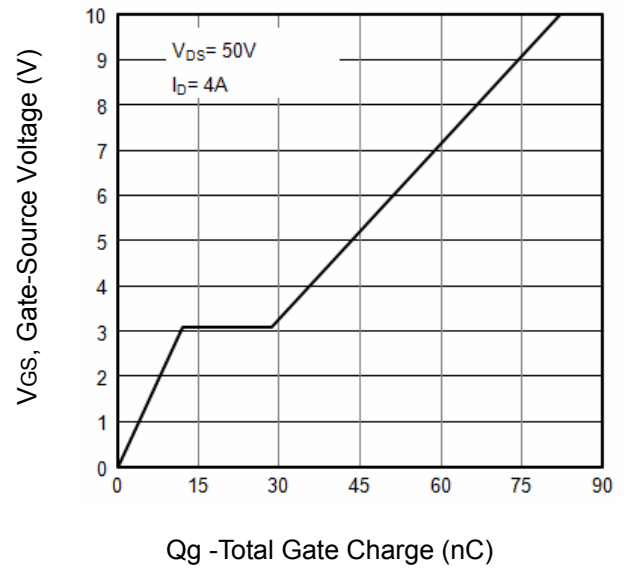

Fig8. Typical Gate Charge Vs.Gate-Source Voltage

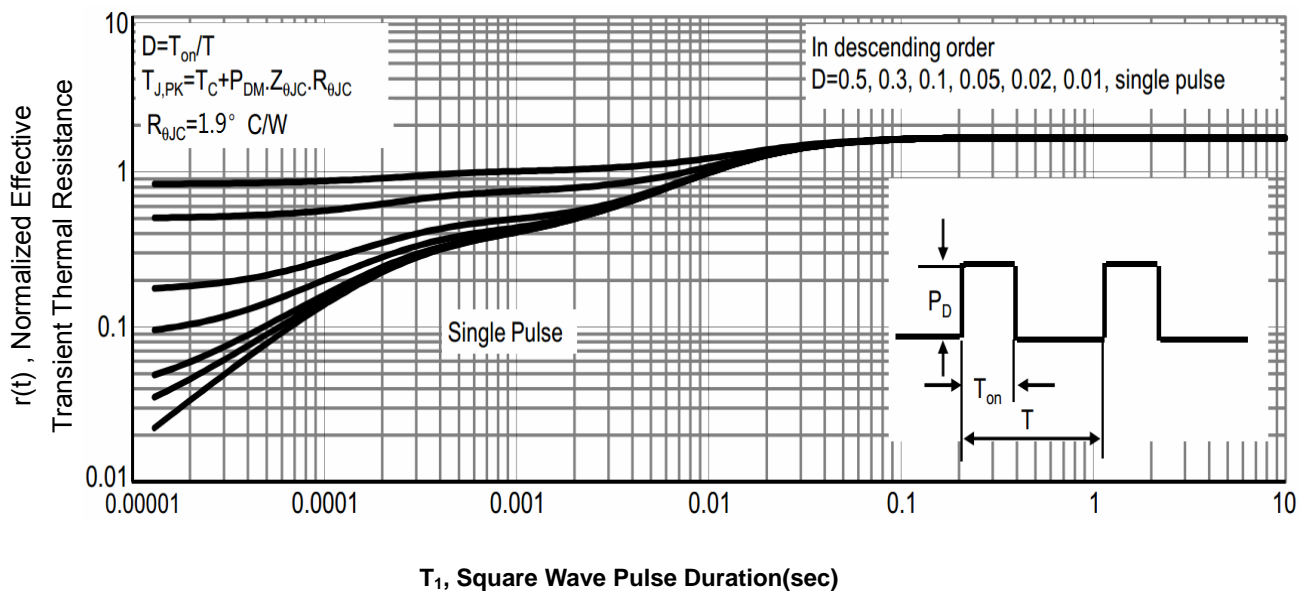

Fig9. T1, Transient Thermal Response Curve

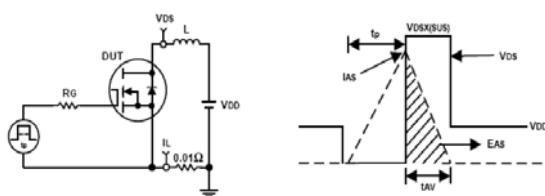

Fig10. Unclamped Inductive Test Circuit and waveforms

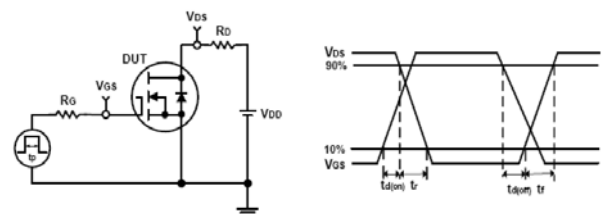
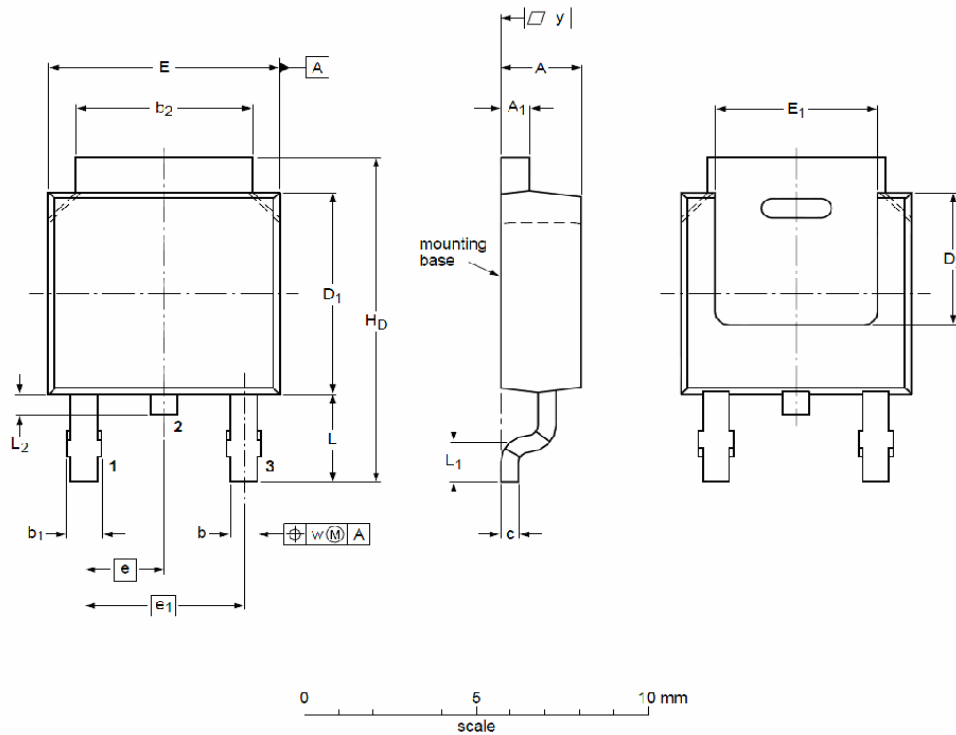

Fig11. Switching Time Test Circuit and waveforms

TO-252 Package Outline



DIMENSIONS (unit : mm)

Symbol	Min	Typ	Max	Symbol	Min	Typ	Max
A	2.22	2.30	2.38	A ₁	0.46	0.58	0.93
b	0.71	0.79	0.89	b ₁	0.90	0.98	1.10
b ₂	5.00	5.30	5.46	c	0.20	0.40	0.56
D ₁	5.98	6.05	6.22	D ₂	--	4.00	--
E	6.47	6.60	6.73	E ₁	5.10	5.28	5.45
e	--	2.28	--	e ₁	--	4.57	--
H _D	9.60	10.08	10.40	L	2.75	2.95	3.05
L ₁	--	0.50	--	L ₂	0.80	0.90	1.10
w	--	0.20	--	y	0.20	--	--

Customer Service

Sales and Service:

sales@vgsemi.com

Vanguard Semiconductor CO., LTD

TEL: (86-755) -26902410

FAX: (86-755) -26907027

WEB: www.vgsemi.com