

Features

- P-Channel, -5V Logic Level Control
- Very low on-resistance $R_{DS(on)}$ @ $V_{GS}=-4.5\text{ V}$
- Fast Switching
- Enhancement mode
- 100% Avalanche Tested
- Pb-free lead plating; RoHS compliant



Part ID	Package Type	Marking	Tape and reel information
VSD025P04MS	TO-252	025P04M	2500pcs/Reel

V_{DS}	-40	V
$R_{DS(on),TYP}@ V_{GS}=-10\text{ V}$	25	m Ω
$R_{DS(on),TYP}@ V_{GS}=-4.5\text{ V}$	31	m Ω
I_D	-30	A

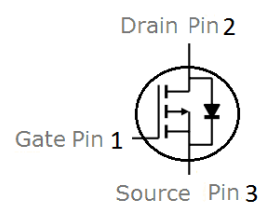
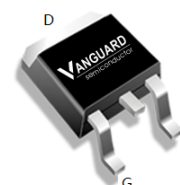
TO-252

Maximum ratings, at $T_j=25\text{ }^\circ\text{C}$, unless otherwise specified

Symbol	Parameter	Rating	Unit	
Common Ratings ($T_c=25\text{ }^\circ\text{C}$ Unless Otherwise Noted)				
V_{GS}	Gate-Source Voltage	± 20	V	
$V_{(BR)DSS}$	Drain-Source Breakdown Voltage	-40	V	
$T_{STG} T_J$	Storage and operating temperature range ①	-55 to 175	$^\circ\text{C}$	
I_S	Diode Continuous Forward Current	$T_c=25\text{ }^\circ\text{C}$ -30	A	
Mounted on Large Heat Sink				
I_D	Continuous Drain current @ $V_{GS}=-10\text{ V}$	$T_c=25\text{ }^\circ\text{C}$	-30	A
		$T_c=100\text{ }^\circ\text{C}$	-19	A
I_{DM}	Pulse Drain Current Tested ②	$T_c=25\text{ }^\circ\text{C}$	-100	A
P_D	Maximum Power Dissipation	$T_c=25\text{ }^\circ\text{C}$	50	W
$R_{\theta JC}$	Thermal Resistance-Junction to Case		3	$^\circ\text{C/W}$
$R_{\theta JA}$	Thermal Resistance Junction-Ambient		42	$^\circ\text{C/W}$
Drain-Source Avalanche Ratings				
EAS	Avalanche Energy, Single Pulsed ③		289	mJ

Symbol	Parameter	Condition	Min.	Typ.	Max.	Unit
Static Electrical Characteristics @ T_j = 25°C (unless otherwise stated)						
V _{(BR)DSS}	Drain-Source Breakdown Voltage	V _{GS} =0V I _D =-250μA	-40	--	--	V
I _{DSS}	Zero Gate Voltage Drain Current	V _{DS} =-40V, V _{GS} =0V	--	--	-1	μA
	Zero Gate Voltage Drain Current(T _j =125°C)	V _{DS} =-40V, V _{GS} =0V	--	--	-100	μA
I _{GSS}	Gate-Body Leakage Current	V _{GS} =±20V, V _{DS} =0V	--	--	±100	nA
V _{GS(TH)}	Gate Threshold Voltage	V _{DS} =V _{GS} , I _D =-250μA	-1.0	-1.8	-2.5	V
R _{DS(ON)}	Drain-Source On-State Resistance ②	V _{GS} =-10V, I _D =-15A	--	25	30	mΩ
R _{DS(ON)}	Drain-Source On-State Resistance ②	V _{GS} =-4.5V, I _D =-5A	--	31	38	mΩ
Dynamic Electrical Characteristics @ T_j = 25°C (unless otherwise stated)						
C _{iss}	Input Capacitance	V _{DS} =-30V, V _{GS} =0V, f=1MHz	--	1675	--	pF
C _{oss}	Output Capacitance		--	155	--	pF
C _{rss}	Reverse Transfer Capacitance		--	105	--	pF
Q _g	Total Gate Charge	V _{DS} =-20V, I _D =-10A, V _{GS} =-10V	--	27	--	nC
Q _{gs}	Gate-Source Charge		--	7.2	--	nC
Q _{gd}	Gate-Drain Charge		--	5.5	--	nC
Switching Characteristics						
t _{d(on)}	Turn-on Delay Time	V _{DD} =-20V, I _D =-10A, R _G =6.8Ω, V _{GS} =-10V	--	14	--	nS
t _r	Turn-on Rise Time		--	18	--	nS
t _{d(off)}	Turn-Off Delay Time		--	36	--	nS
t _f	Turn-Off Fall Time		--	25	--	nS
Source- Drain Diode Characteristics @ T_j = 25°C (unless otherwise stated)						
V _{SD}	Forward on voltage	I _{SD} =-15A, V _{GS} =0V	--	-0.89	-1.2	V
t _{rr}	Reverse Recovery Time	T _j =25°C, I _{sd} =-10A, V _{GS} =0V	--	35	--	nS
Q _{rr}	Reverse Recovery Charge	di/dt=-100A/μs		32		nC

NOTE:

- ① Repetitive rating; pulse width limited by max. junction temperature.
- ② Pulse width ≤ 300μs; duty cycle ≤ 2%.
- ③ Limited by T_{Jmax}, starting T_J = 25°C, L = 0.5mH, R_G = 25Ω, I_{AS} = -34A, V_{GS} = -10V. Part not recommended for use above this value

Typical Characteristics

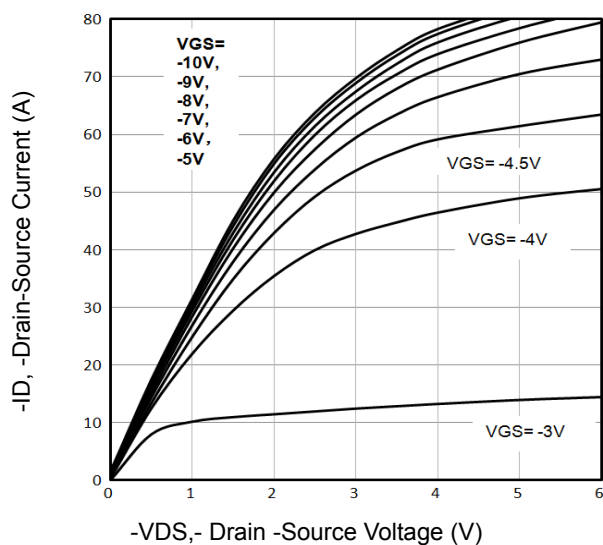

Fig1. Typical Output Characteristics

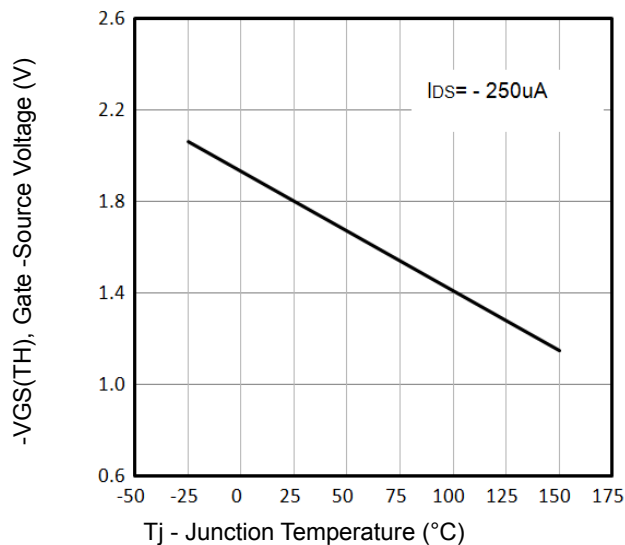

Fig2. $-V_{GS(TH)}$ Gate -Source Voltage Vs. T_j

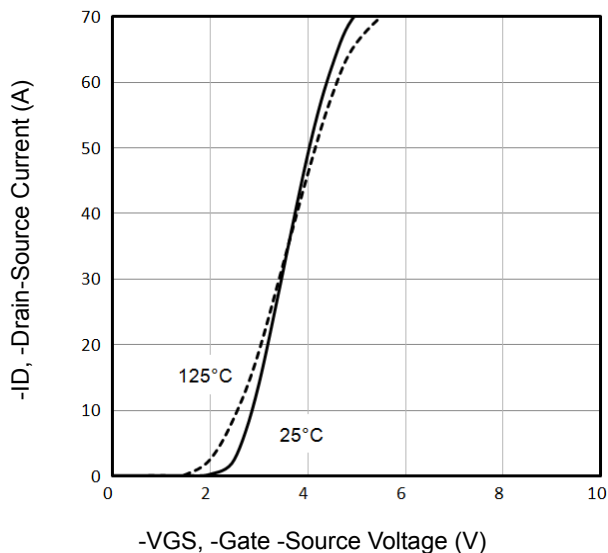

Fig3. Typical Transfer Characteristics

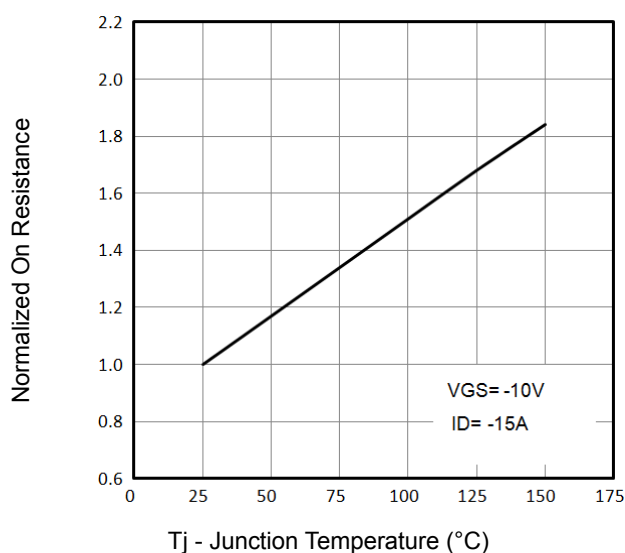

Fig4. Normalized On-Resistance Vs. T_j

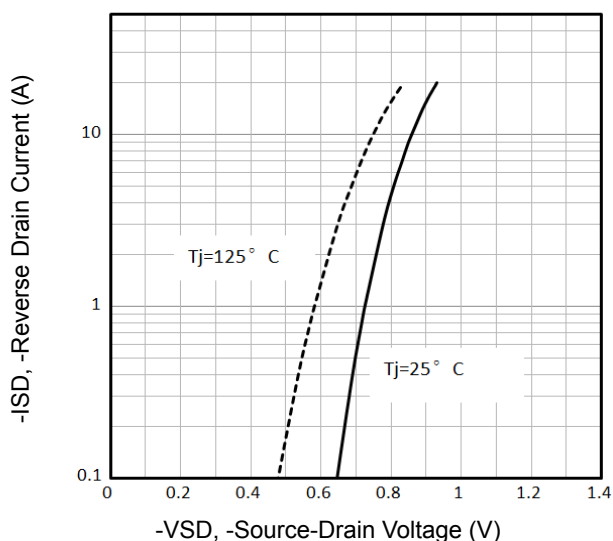

Fig5. Typical Source-Drain Diode Forward Voltage

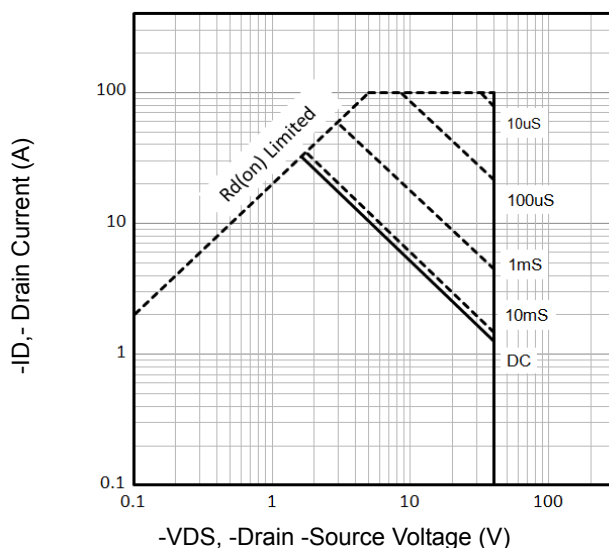

Fig6. Maximum Safe Operating Area

Typical Characteristics

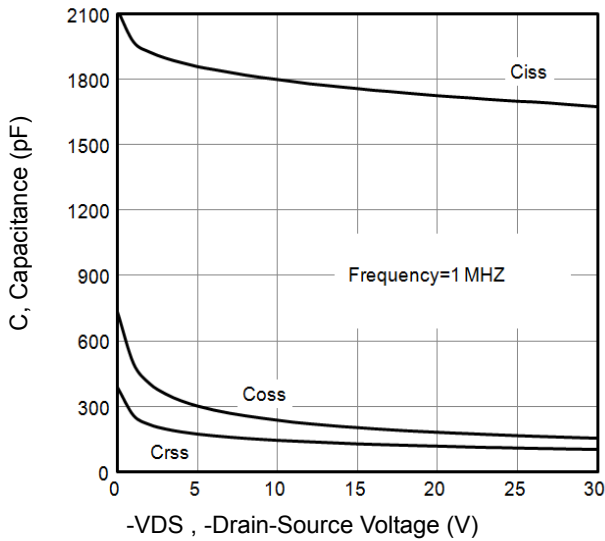

Fig7. Typical Capacitance Vs.Drain-Source Voltage

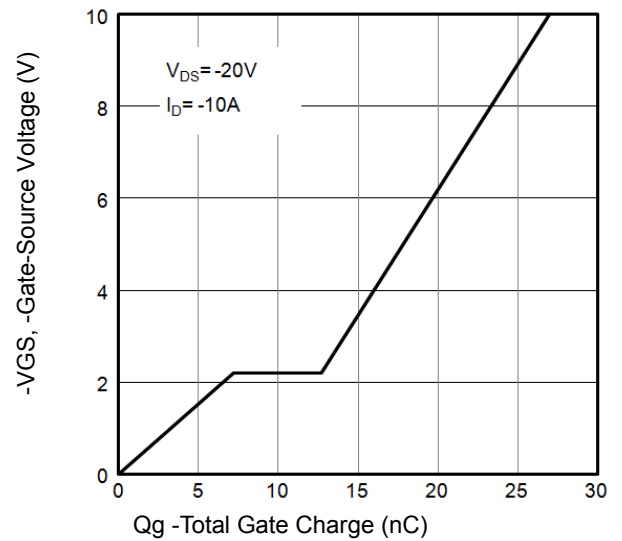

Fig8. Typical Gate Charge Vs.Gate-Source Voltage

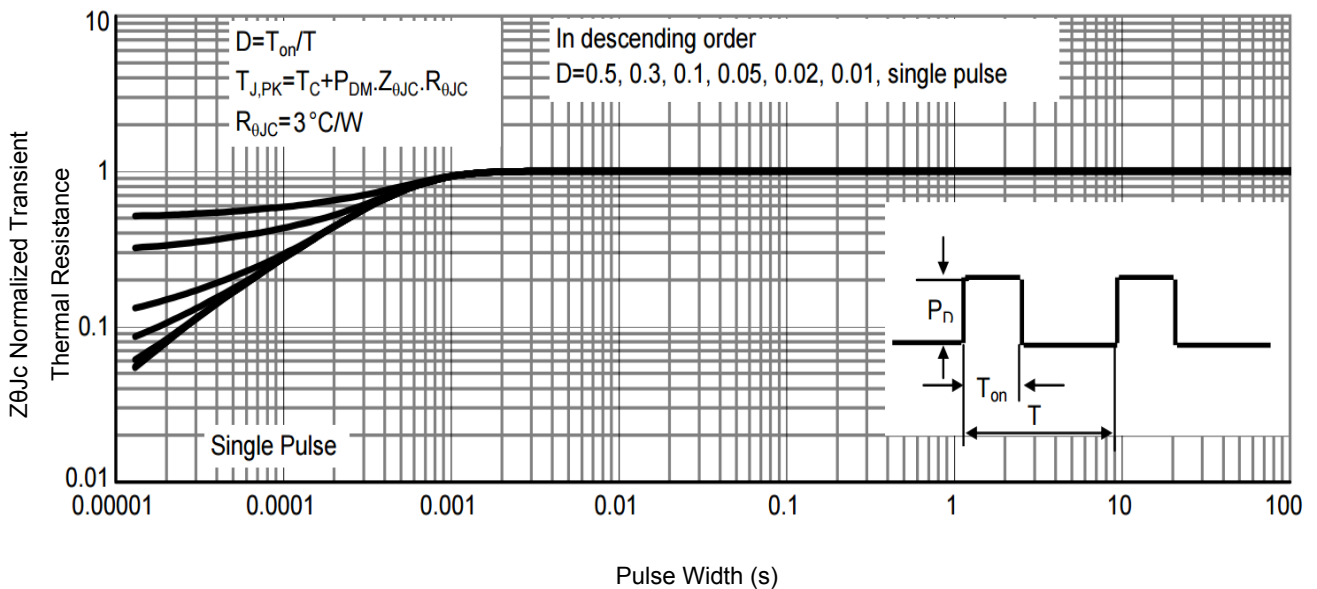

Fig9. Normalized Maximum Transient Thermal Impedance

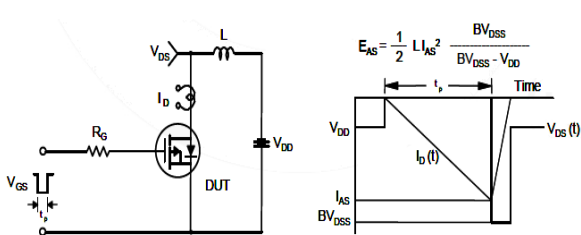

Fig10. Unclamped Inductive Test Circuit and Waveforms

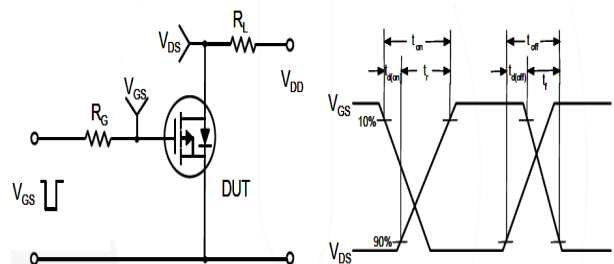
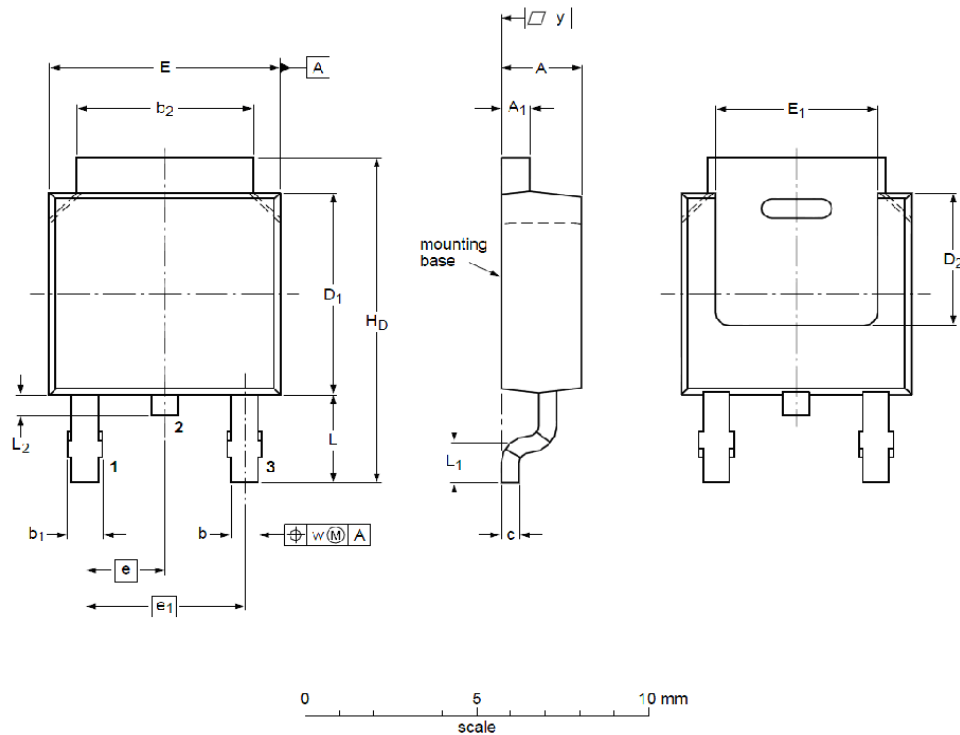

Fig11. Switching Time Test Circuit and waveforms

TO-252 Package Outline Data



DIMENSIONS (unit : mm)

Symbol	Min	Typ	Max	Symbol	Min	Typ	Max
A	2.22	2.30	2.38	A ₁	0.46	0.58	0.93
b	0.71	0.79	0.89	b ₁	0.90	0.98	1.10
b ₂	5.00	5.30	5.46	c	0.20	0.40	0.56
D ₁	5.98	6.05	6.22	D ₂	--	4.00	--
E	6.47	6.60	6.73	E ₁	5.10	5.28	5.45
e	--	2.28	--	e ₁	--	4.57	--
H _D	9.60	10.08	10.40	L	2.75	2.95	3.05
L ₁	--	0.50	--	L ₂	0.80	0.90	1.10
w	--	0.20	--	y	0.20	--	--

Customer Service

Sales and Service:

sales@vgsemi.com

Vanguard Semiconductor CO., LTD

TEL: (86-755) -26902410

FAX: (86-755) -26907027

WEB: www.vgsemi.com