



<p>Description</p> <p>These N-Channel enhancement mode power field effect transistors are using trench DMOS technology. This advanced technology has been especially tailored to minimize on-state resistance, provide superior switching performance, and with stand high energy pulse in the avalanche and commutation mode. These devices are well suited for high efficiency fast switching applications.</p> <p>Features</p> <ul style="list-style-type: none"> ◆ 40V, 120A, $R_{DS(on).max}=3.5m\Omega@V_{GS} = 10V$ ◆ Improved dv/dt capability ◆ Fast switching ◆ 100% EAS Guaranteed ◆ Green device available <p>Applications</p> <ul style="list-style-type: none"> ◆ Motor Drives ◆ UPS ◆ DC-DC Converter 	<p>Product Summary</p> <table> <tr> <td>V_{DSS}</td> <td>40V</td> </tr> <tr> <td>$R_{DS(on).max}@V_{GS}=10V$</td> <td>3.5m$\Omega$</td> </tr> <tr> <td>$I_D$</td> <td>120A</td> </tr> </table> <p>Pin Configuration</p> <div style="display: flex; justify-content: space-around; align-items: center;"> <div style="text-align: center;">  <p>TO-252</p> </div> <div style="text-align: center;">  <p>TO-251</p> </div> </div> <div style="text-align: center; margin-top: 20px;">  <p>Schematic</p> </div>	V_{DSS}	40V	$R_{DS(on).max}@V_{GS}=10V$	3.5m Ω	I_D	120A
V_{DSS}	40V						
$R_{DS(on).max}@V_{GS}=10V$	3.5m Ω						
I_D	120A						

Absolute Maximum Ratings $T_C = 25^\circ C$ unless otherwise noted

Parameter	Symbol	Value	Unit
Drain-Source Voltage	V_{DSS}	40	V
Continuous drain current ($T_C = 25^\circ C$) ¹⁾	I_D	120	A
Continuous drain current ($T_C = 100^\circ C$) ¹⁾		82	A
Pulsed drain current ²⁾	I_{DM}	480	A
Gate-Source voltage	V_{GSS}	± 20	V
Avalanche energy ³⁾	E_{AS}	544	mJ
Power Dissipation ($T_C = 25^\circ C$)	P_D	130	W
Storage Temperature Range	T_{STG}	-55 to +150	$^\circ C$
Operating Junction Temperature Range	T_J	-55 to +150	$^\circ C$

Thermal Characteristics

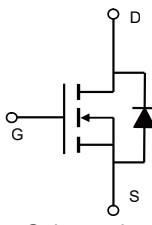
Parameter	Symbol	Value	Unit
Thermal Resistance, Junction-to-Case	$R_{\theta JC}$	0.96	$^\circ C/W$
Thermal Resistance, Junction-to-Ambient	$R_{\theta JA}$	68	$^\circ C/W$

Package Marking and Ordering Information

Device	Device Package	Marking
VSM120N04-T2	TO-252	VSM120N04-T2
VSM120N04-T1	TO-251	VSM120N04-T1

Electrical Characteristics

 $T_J = 25^\circ\text{C}$ unless otherwise noted

Parameter	Symbol	Test Condition	Min.	Typ.	Max.	Unit
Static characteristics						
Drain-source breakdown voltage	BV_{DSS}	$V_{GS}=0\text{ V}, I_D=250\mu\text{A}$	40	---	---	V
Gate threshold voltage	$V_{GS(th)}$	$V_{DS}=V_{GS}, I_D=250\mu\text{A}$	1.3	---	2.5	V
Drain-source leakage current	I_{DSS}	$V_{DS}=40\text{ V}, V_{GS}=0\text{ V}, T_J = 25^\circ\text{C}$	---	---	1	μA
		$V_{DS}=40\text{ V}, V_{GS}=0\text{ V}, T_J = 125^\circ\text{C}$	---	---	10	μA
Gate leakage current, Forward	I_{GSSF}	$V_{GS}=20\text{ V}, V_{DS}=0\text{ V}$	---	---	100	nA
Gate leakage current, Reverse	I_{GSSR}	$V_{GS}=-20\text{ V}, V_{DS}=0\text{ V}$	---	---	-100	nA
Drain-source on-state resistance	$R_{DS(on)}$	$V_{GS}=10\text{ V}, I_D=20\text{ A}$	---	2.7	3.5	m Ω
		$V_{GS}=4.5\text{ V}, I_D=10\text{ A}$	---	3.8	6.0	m Ω
Forward transconductance	g_{fs}	$V_{DS}=5\text{ V}, I_D=50\text{A}$	26	---	---	S
Dynamic characteristics						
Input capacitance	C_{iss}	$V_{DS} = 20\text{ V}, V_{GS} = 0\text{ V},$ $F = 1\text{MHz}$	---	7810	---	pF
Output capacitance	C_{oss}		---	677	---	
Reverse transfer capacitance	C_{rss}		---	370	---	
Turn-on delay time	$t_{d(on)}$	$V_{DD} = 20\text{V}, V_{GS}=10\text{V}, I_D = 20\text{ A}$	---	15	---	ns
Rise time	t_r		---	17	---	
Turn-off delay time	$t_{d(off)}$		---	52	---	
Fall time	t_f		---	23	---	
Gate resistance	R_g	$V_{GS}=0\text{V}, V_{DS}=0\text{V}, F=1\text{MHz}$	---	2.12	---	Ω
Gate charge characteristics						
Gate to source charge	Q_{gs}	$V_{DS}=20\text{ V}, I_D=100\text{A},$ $V_{GS}= 10\text{ V}$	---	36.4	---	nC
Gate to drain charge	Q_{gd}		---	37.3	---	
Gate charge total	Q_g		---	139	---	
Drain-Source diode characteristics and Maximum Ratings						
Continuous Source Current	I_S		---	---	120	A
Pulsed Source Current ⁴⁾	I_{SM}		---	---	480	A
Diode Forward Voltage	V_{SD}	$V_{GS}=0\text{V}, I_S=50\text{A}, T_J=25^\circ\text{C}$	---	---	1.2	V
Reverse Recovery Time	t_{rr}	$I_S=100\text{A}, di/dt=100\text{A}/\mu\text{s},$	---	42	---	ns
Reverse Recovery Charge	Q_{rr}	$T_J=25^\circ\text{C}$	---	120	---	nC

Notes:

- 1: The maximum junction current rating is package limited.
- 2: Repetitive Rating: Pulse width limited by maximum junction temperature.
- 3: $V_{DD}=20\text{V}, V_{GS}=10\text{V}, L=1\text{mH}, I_{AS}=33\text{A}, R_G=25\Omega,$ Starting $T_J=25^\circ\text{C}$.
- 4: Pulse Test: Pulse Width $\leq 300\ \mu\text{s}$, Duty Cycle $\leq 2\%$.

Electrical Characteristics Diagrams

Figure 1. Typ. Output Characteristics

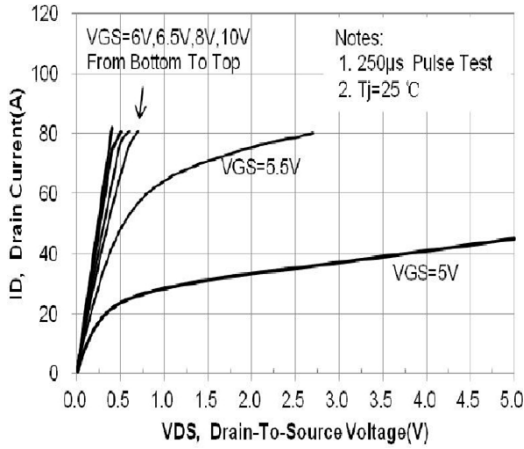

Figure 2. Transfer Characteristics

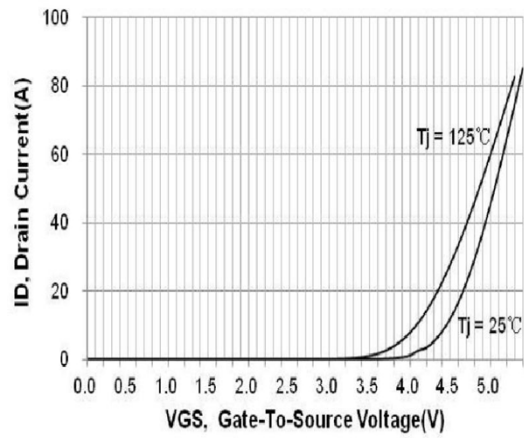

Figure 3. Capacitance Characteristics

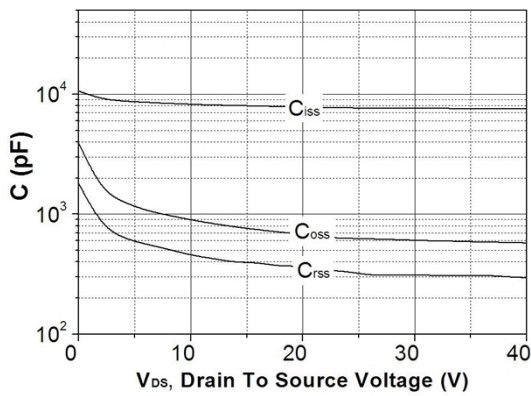

Figure 4. Gate Charge Waveform

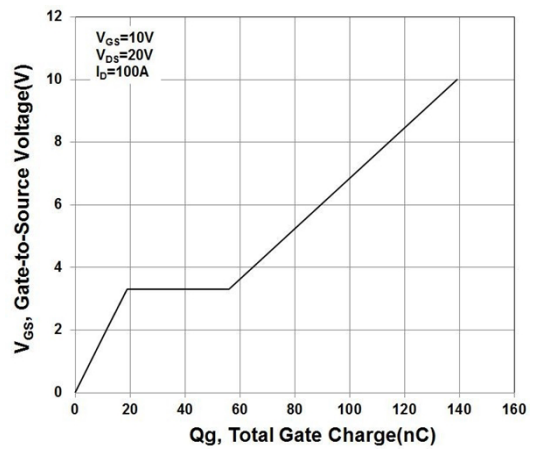

Figure 5. Body-Diode Characteristics

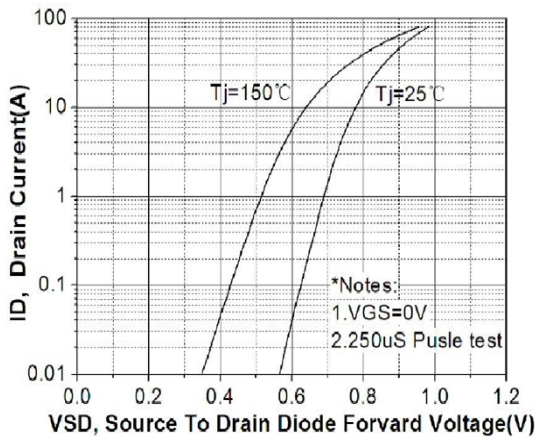

Figure 6. Maximum Safe Operating Area

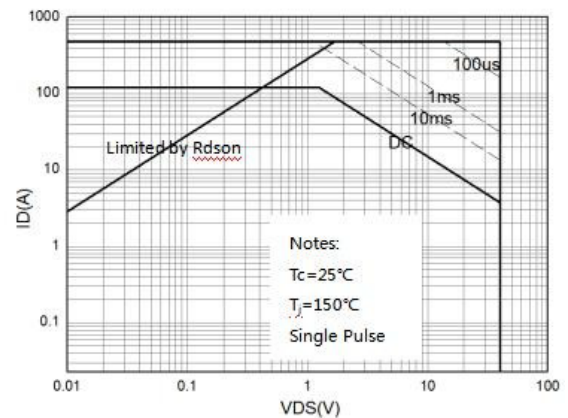

Figure 6. Normalized Maximum Transient Thermal Impedance (RthJC)

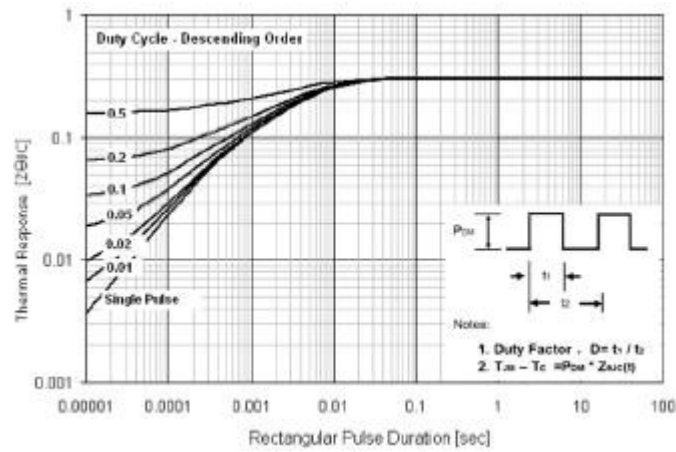
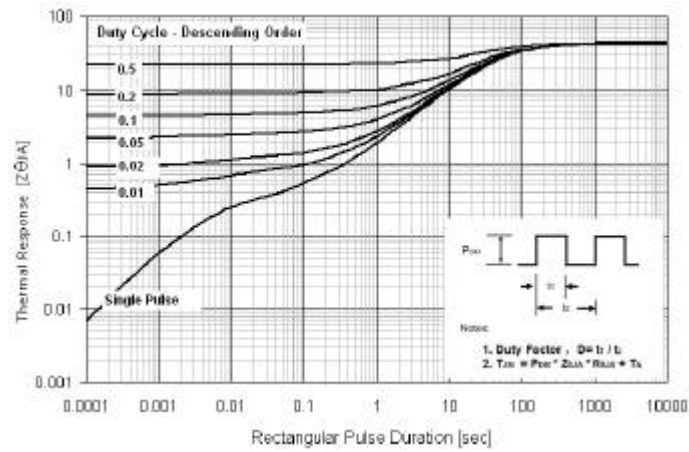

Figure 7. Normalized Maximum Transient Thermal Impedance (RthJA)



Test Circuit & Waveform

Figure 8. Gate Charge Test Circuit & Waveform

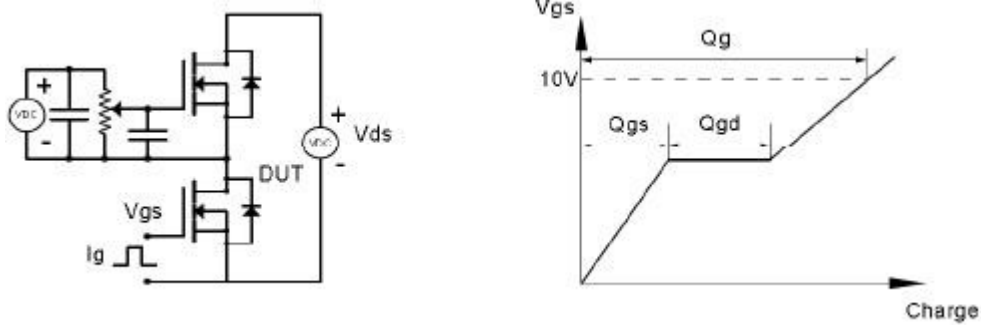

Figure 9. Resistive Switching Test Circuit & Waveforms

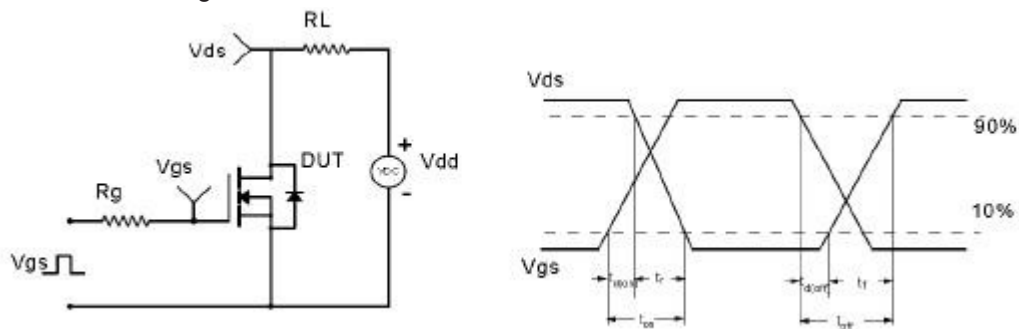

Figure 10. Unclamped Inductive Switching (UIS) Test Circuit & Waveform

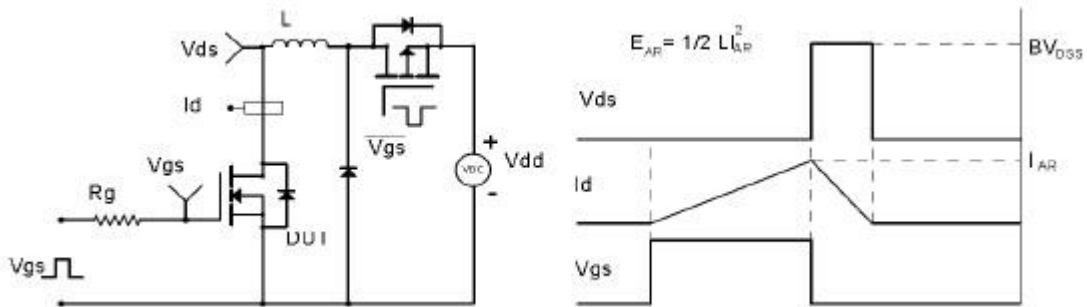

Figure 11. Diode Recovery Circuit & Waveform

