

## Features

- N+P Channel
- Enhancement mode
- Very low on-resistance
- Fast Switching
- Pb-free lead plating; RoHS compliant

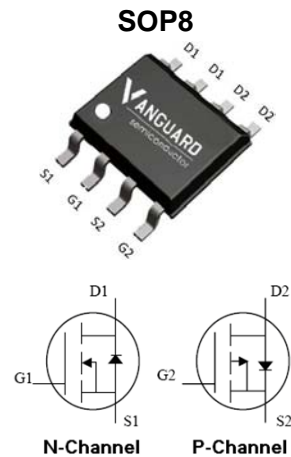

Part ID	Package Type	Marking	Tape and reel information
VSO050M04MD	SOP8	050M04MD	3000pcs/Reel



## Absolute Maximum Ratings

Symbol	Parameter	Rating		Unit
		NMOS	PMOS	
<b>Common Ratings (T<sub>c</sub>=25°C Unless Otherwise Noted)</b>				
V <sub>GS</sub>	Gate-Source Voltage	±16	±16	V
V <sub>(BR)DSS</sub>	Drain-Source Breakdown Voltage	40	-40	V
T <sub>J</sub>	Maximum Junction Temperature <sup>①</sup>	150		°C
T <sub>STG</sub>	Storage Temperature Range	-50 to 150		°C
I <sub>S</sub>	Diode Continuous Forward Current	T <sub>A</sub> =25°C		A
<b>Mounted on Large Heat Sink</b>				
I <sub>DM</sub>	Pulse Drain Current Tested <sup>②</sup>	T <sub>A</sub> =25°C		A
I <sub>D</sub>	Continuous Drain Current	T <sub>A</sub> =25°C		A
		T <sub>A</sub> =100°C		
P <sub>D</sub>	Power dissipation for Dual Operation	T <sub>A</sub> =25°C		W
R <sub>θJC</sub>	Thermal Resistance-Junction to Case			°C/W
R <sub>θJA</sub>	Thermal Resistance Junction-Ambient			°C/W

**N-Channel Electrical Characteristics**

Symbol	Parameter	Condition	Min	Typ	Max	Unit
<b>Static Electrical Characteristics @ T<sub>J</sub> = 25°C (unless otherwise stated)</b>						
V <sub>(BR)DSS</sub>	Drain-Source Breakdown Voltage	V <sub>GS</sub> =0V I <sub>D</sub> =250μA	40	--	--	V
I <sub>DSS</sub>	Zero Gate Voltage Drain Current(T <sub>A</sub> =25°C)	V <sub>DS</sub> =40V,V <sub>GS</sub> =0V	--	--	1	μA
	Zero Gate Voltage Drain Current(T <sub>A</sub> =125°C)	V <sub>DS</sub> =40V,V <sub>GS</sub> =0V	--	--	100	μA
I <sub>GSS</sub>	Gate-Body Leakage Current	V <sub>GS</sub> =±16V,V <sub>DS</sub> =0V	--	--	±100	nA
V <sub>GS(TH)</sub>	Gate Threshold Voltage	V <sub>DS</sub> =V <sub>GS</sub> ,I <sub>D</sub> =250μA	1.0	1.8	2.5	V
R <sub>DS(ON)</sub>	Drain-Source On-State Resistance②	V <sub>GS</sub> =10V, I <sub>D</sub> =6A	--	32	45	mΩ
		V <sub>GS</sub> =4.5V, I <sub>D</sub> =4A	--	40	55	mΩ
		V <sub>GS</sub> =3.3V, I <sub>D</sub> =2A	--	52	65	mΩ
<b>Dynamic Electrical Characteristics @ T<sub>J</sub> = 25°C (unless otherwise stated)</b>						
C <sub>iss</sub>	Input Capacitance	V <sub>DS</sub> =30V,V <sub>GS</sub> =0V, f=1MHz	--	320	--	pF
C <sub>oss</sub>	Output Capacitance		--	45	--	pF
C <sub>rss</sub>	Reverse Transfer Capacitance		--	35	--	pF
Q <sub>g</sub>	Total Gate Charge	V <sub>DS</sub> =20V,I <sub>D</sub> =3A, V <sub>GS</sub> =10V	--	8.8	--	nC
Q <sub>gs</sub>	Gate Source Charge		--	1.9	--	nC
Q <sub>gd</sub>	Gate Drain Charge		--	2.2	--	nC
<b>Switching Characteristics</b>						
t <sub>d(on)</sub>	Turn on Delay Time	V <sub>DD</sub> =20V, I <sub>D</sub> =3A, R <sub>G</sub> =3.3Ω, V <sub>GS</sub> =10V	--	5.8	--	nS
t <sub>r</sub>	Turn on Rise Time		--	2.8	--	nS
t <sub>d(off)</sub>	Turn Off Delay Time		-	16	--	nS
t <sub>f</sub>	Turn Off Fall Time		--	2.2	--	nS
<b>Source Drain Diode Characteristics</b>						
V <sub>SD</sub>	Forward on voltage	I <sub>SD</sub> =6A,V <sub>GS</sub> =0V	--	0.85	1.2	V
t <sub>rr</sub>	Reverse Recovery Time	T <sub>J</sub> =25°C,I <sub>sd</sub> =2A, V <sub>GS</sub> =0V	--	25	--	nS
Q <sub>rr</sub>	Reverse Recovery Charge	di/dt=-100A/μs	--	18	--	nC

**P-Channel Electrical Characteristics**

Symbol	Parameter	Condition	Min	Typ	Max	Unit
<b>Static Electrical Characteristics @ T<sub>J</sub> = 25°C (unless otherwise stated)</b>						
V <sub>(BR)DSS</sub>	Drain-Source Breakdown Voltage	V <sub>GS</sub> =0V, I <sub>D</sub> =-250μA	-40	--	--	V
I <sub>DSS</sub>	Zero Gate Voltage Drain Current(T <sub>A</sub> =25°C)	V <sub>DS</sub> =-40V, V <sub>GS</sub> =0V	--	--	-1	μA
	Zero Gate Voltage Drain Current(T <sub>A</sub> =125°C)	V <sub>DS</sub> =-40V, V <sub>GS</sub> =0V	--	--	-100	μA
I <sub>GSS</sub>	Gate-Body Leakage Current	V <sub>GS</sub> =±16V, V <sub>DS</sub> =0V	--	--	±100	nA
V <sub>GS(TH)</sub>	Gate Threshold Voltage	V <sub>DS</sub> =V <sub>GS</sub> , I <sub>D</sub> =-250μA	-1.0	-1.8	-2.5	V
R <sub>DS(ON)</sub>	Drain-Source On-State Resistance②	V <sub>GS</sub> =-10V, I <sub>D</sub> =-5A	--	50	65	mΩ
		V <sub>GS</sub> =-4.5V, I <sub>D</sub> =-4A	--	60	75	mΩ
		V <sub>GS</sub> =-3.3V, I <sub>D</sub> =-2A	--	80	90	mΩ
<b>Dynamic Electrical Characteristics @ T<sub>J</sub> = 25°C (unless otherwise stated)</b>						
C <sub>iss</sub>	Input Capacitance	V <sub>DS</sub> =-30V, V <sub>GS</sub> =0V, f=1MHz	--	835	--	pF
C <sub>oss</sub>	Output Capacitance		--	85	--	pF
C <sub>rss</sub>	Reverse Transfer Capacitance		--	65	--	pF
Q <sub>g</sub>	Total Gate Charge	V <sub>DS</sub> =-20V, I <sub>D</sub> =-3A, V <sub>GS</sub> =-10V	--	15.8	--	nC
Q <sub>gs</sub>	Gate Source Charge		--	3.5	--	nC
Q <sub>gd</sub>	Gate Drain Charge		--	3.2	--	nC
<b>Switching Characteristics</b>						
t <sub>d(on)</sub>	Turn on Delay Time	V <sub>DD</sub> =-20V, I <sub>D</sub> =-3A, R <sub>G</sub> =3.3Ω, V <sub>GS</sub> =-10V	--	7.3	--	ns
t <sub>r</sub>	Turn on Rise Time		--	8.8	--	ns
t <sub>d(off)</sub>	Turn Off Delay Time		-	46	--	ns
t <sub>f</sub>	Turn Off Fall Time		--	35	--	ns
<b>Source Drain Diode Characteristics</b>						
V <sub>SD</sub>	Forward on voltage	I <sub>SD</sub> =-2A, V <sub>GS</sub> =0V	--	-0.80	-1.2	V
t <sub>rr</sub>	Reverse Recovery Time	T <sub>J</sub> =25°C, I <sub>SD</sub> =-2A, V <sub>GS</sub> =0V	--	23	--	nS
Q <sub>rr</sub>	Reverse Recovery Charge	di/dt=-100A/μs	--	15	--	nC

Notes: ① Repetitive rating; pulse width limited by max. junction temperature.

② Pulse width ≤ 300μs; duty cycles ≤ 2%.

N-Channel Typical Characteristics

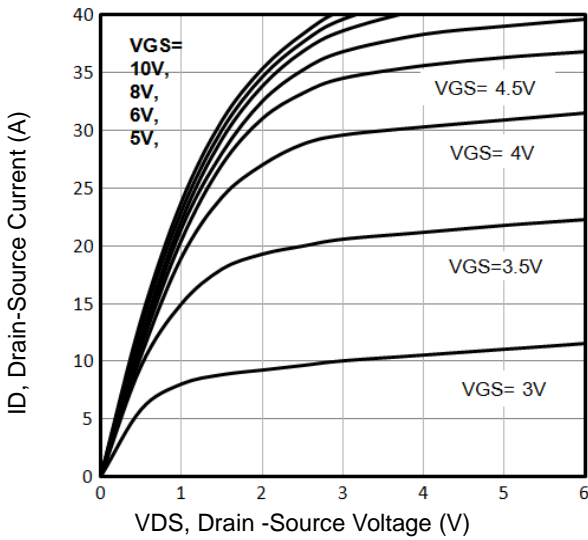

Fig1. Typical Output Characteristics

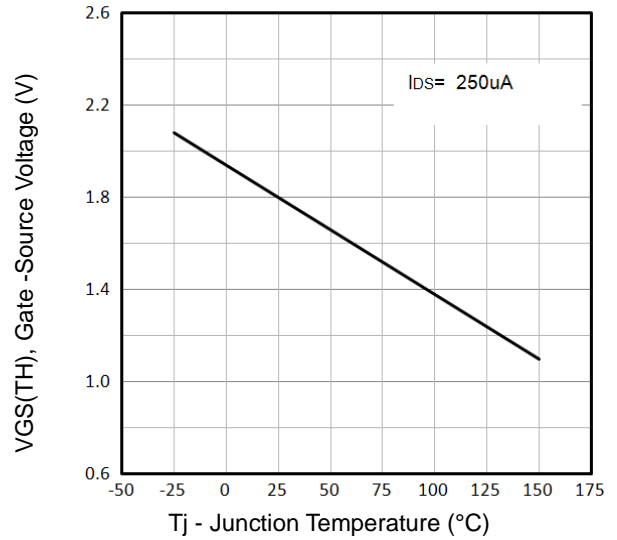

Fig2.  $V_{GS(TH)}$  Gate -Source Voltage Vs.  $T_j$

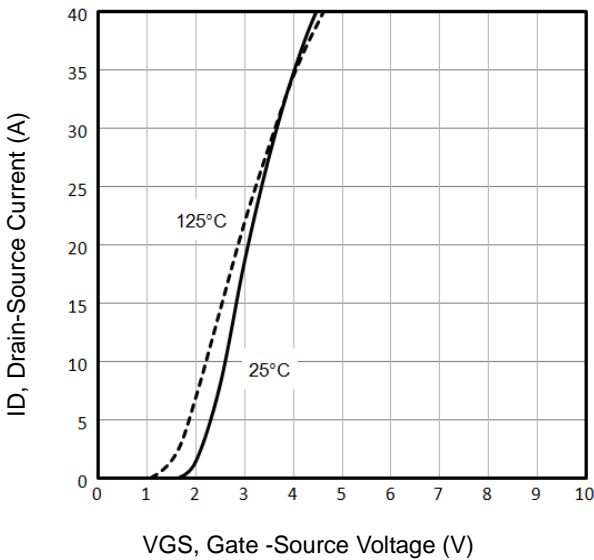

Fig3. Typical Transfer Characteristics

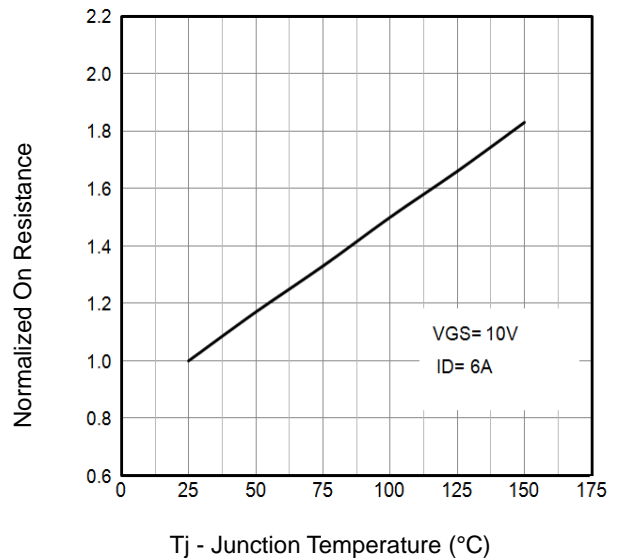

Fig4. Normalized On-Resistance Vs.  $T_j$

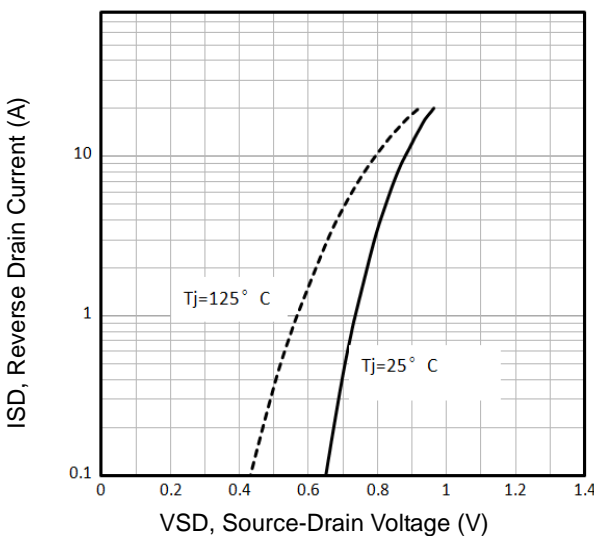

Fig5. Typical Source-Drain Diode Forward Voltage

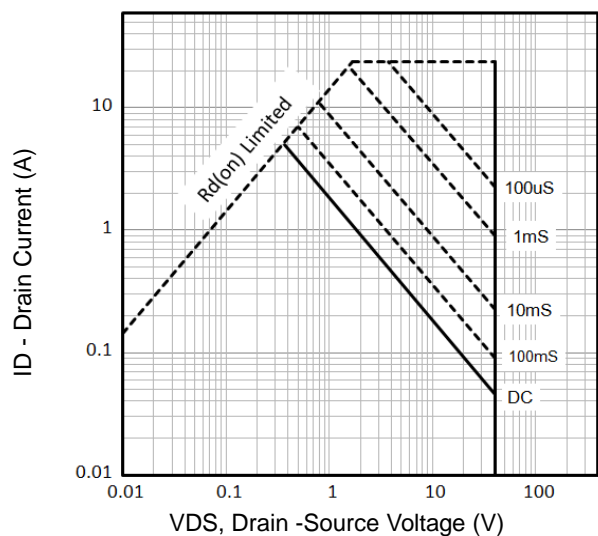

Fig6. Maximum Safe Operating Area

### N-Channel Typical Characteristics

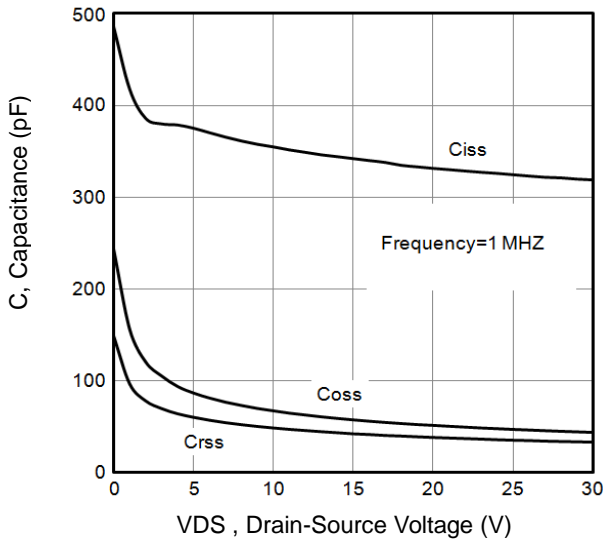

Fig7. Typical Capacitance Vs. Drain-Source Voltage

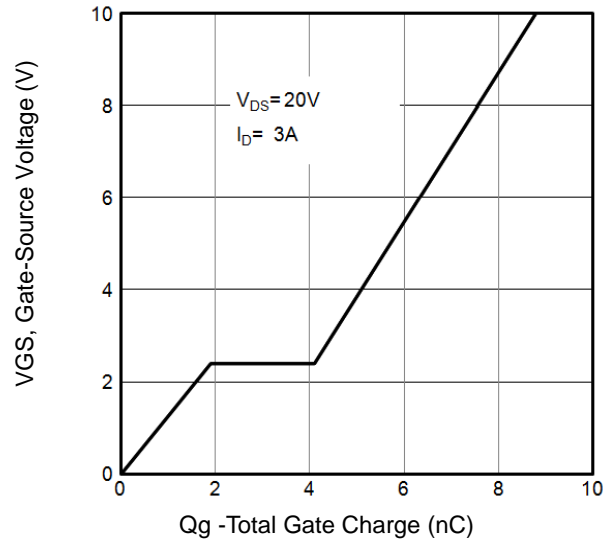

Fig8. Typical Gate Charge Vs. Gate-Source Voltage

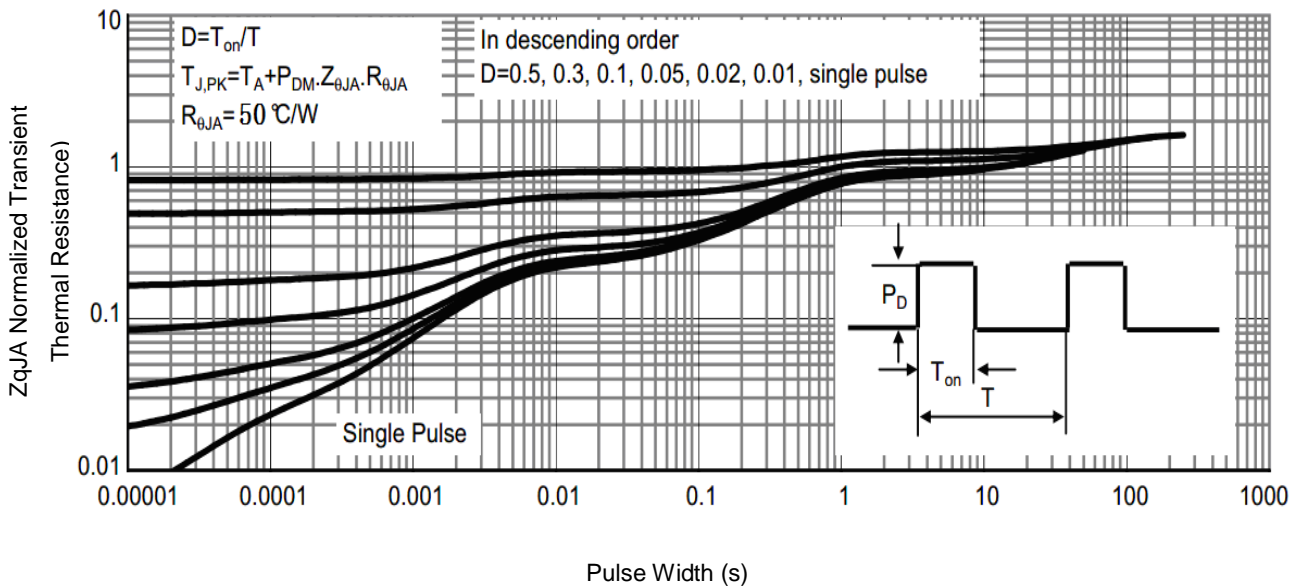

Fig 9 .Normalized Maximum Transient Thermal Impedance

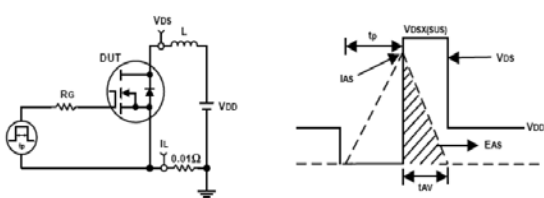

Fig10. Unclamped Inductive Test Circuit and waveforms

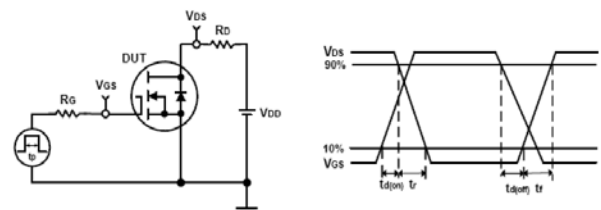

Fig11. Switching Time Test Circuit and waveforms

P-Channel Typical Characteristics

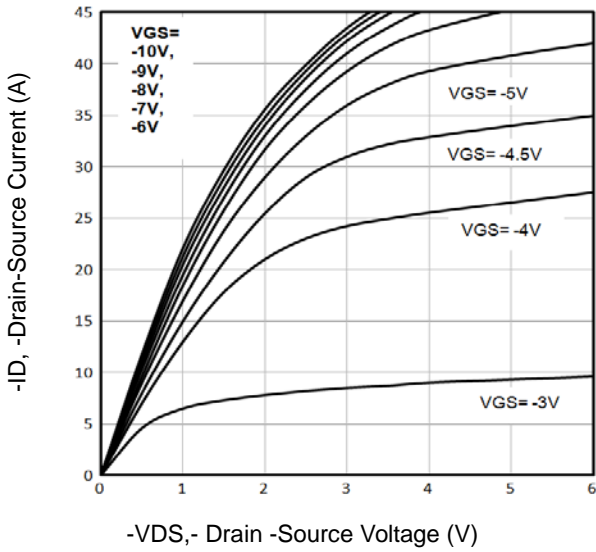

Fig1. Typical Output Characteristics

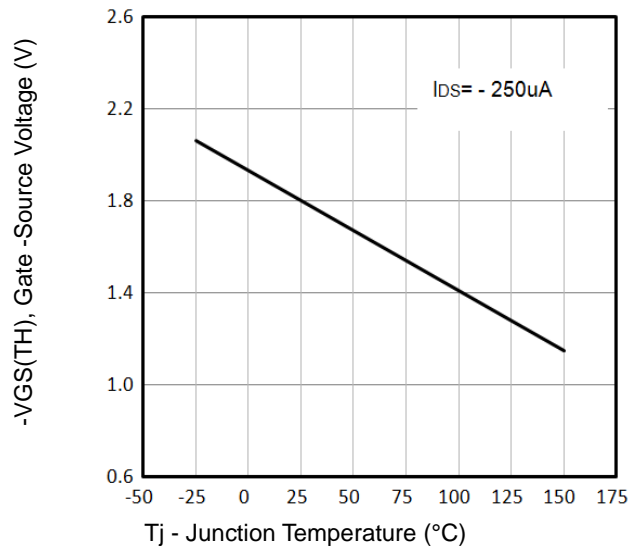

Fig2.  $V_{GS(TH)}$  Gate -Source Voltage Vs.  $T_j$

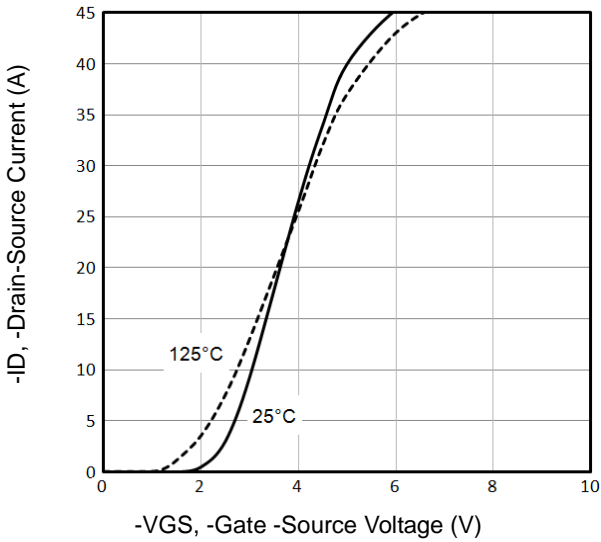

Fig3. Typical Transfer Characteristics

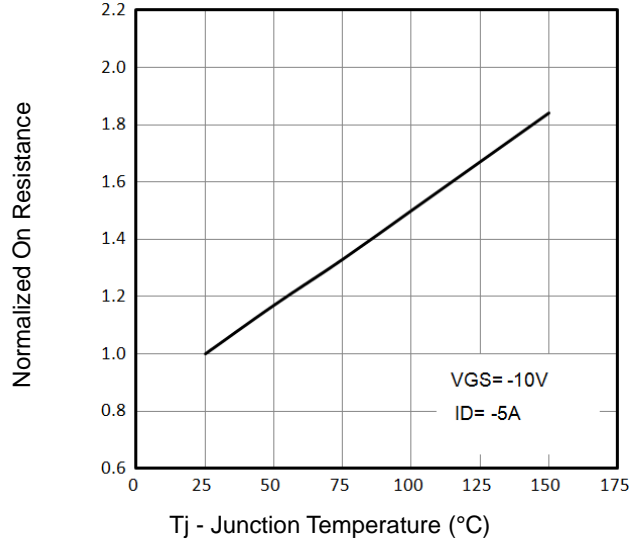

Fig4. Normalized On-Resistance Vs.  $T_j$

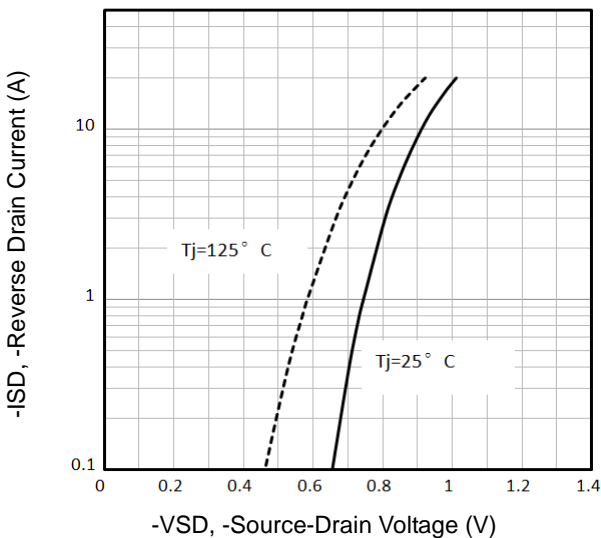

Fig5. Typical Source-Drain Diode Forward Voltage

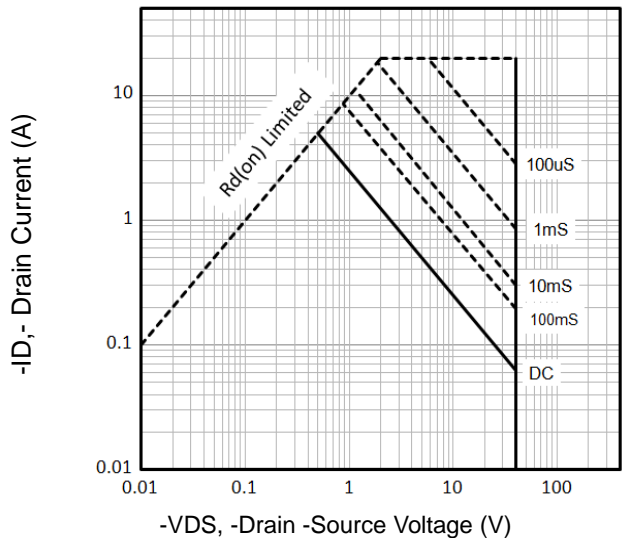

Fig6. Maximum Safe Operating Area

P-Channel Typical Characteristics

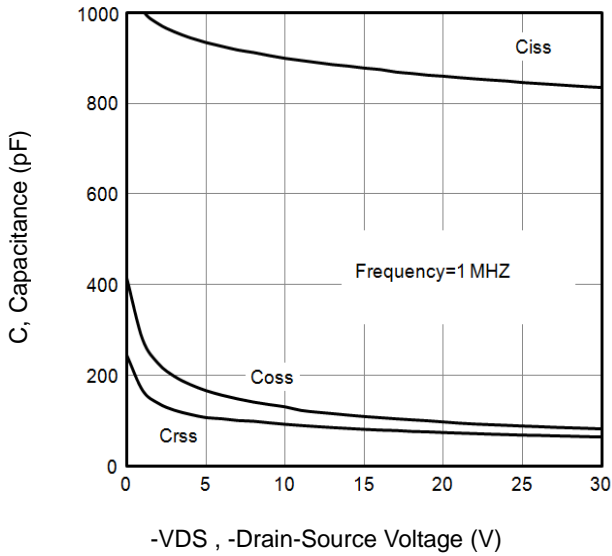

Fig7. Typical Capacitance Vs.Drain-Source Voltage

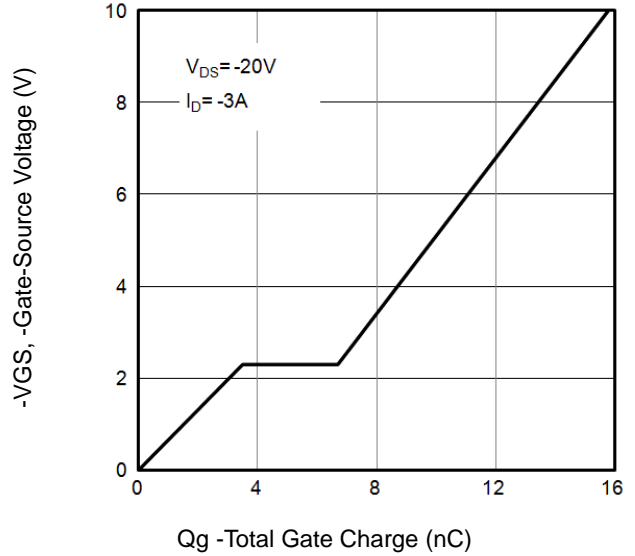

Fig8. Typical Gate Charge Vs.Gate-Source Voltage

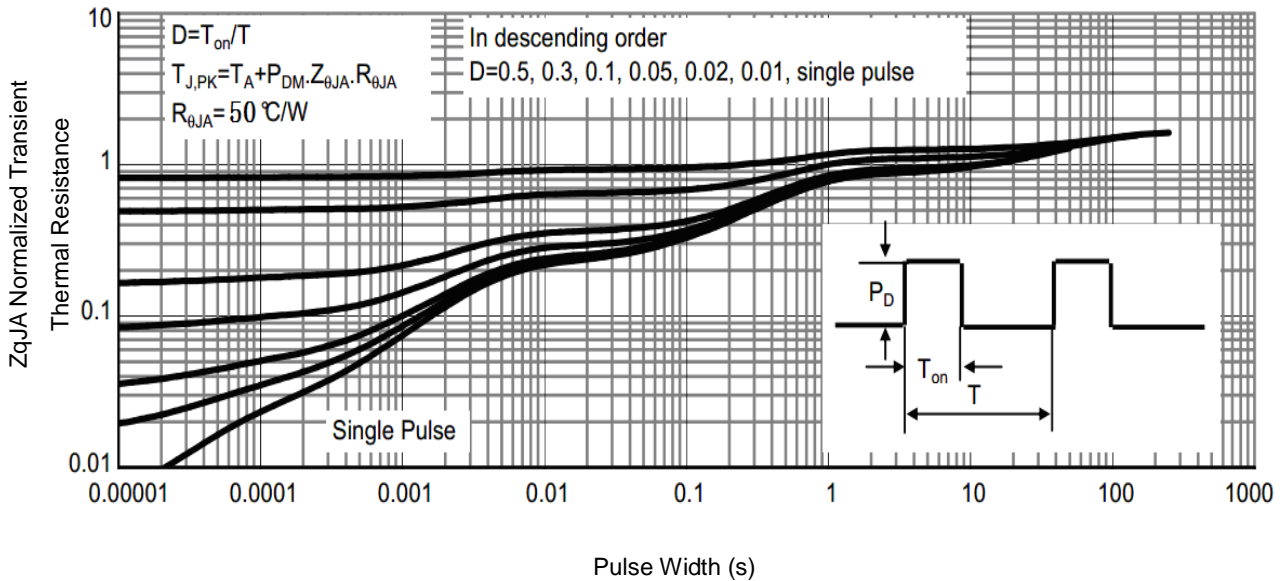

Fig9. Normalized Maximum Transient Thermal Impedance

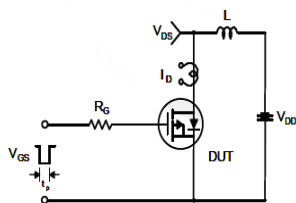

Fig10. Unclamped Inductive Test Circuit and Waveforms

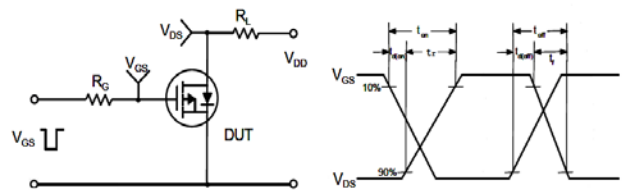
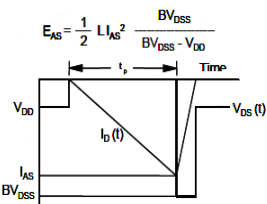
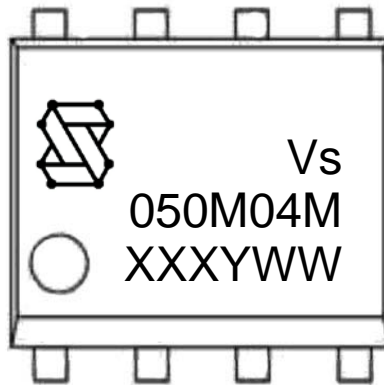

Fig11. Switching Time Test Circuit and waveforms

## Marking Information



1<sup>st</sup> line: Company Code (Vs), Company Logo

2<sup>nd</sup> line: Part Number (050M04M)

3<sup>rd</sup> line: Date code (XXXYWW)

XXX: Wafer Lot Number

Y: Year Code, e.g. E means 2017

WW: Week Code



## SOP8 Package Outline Data

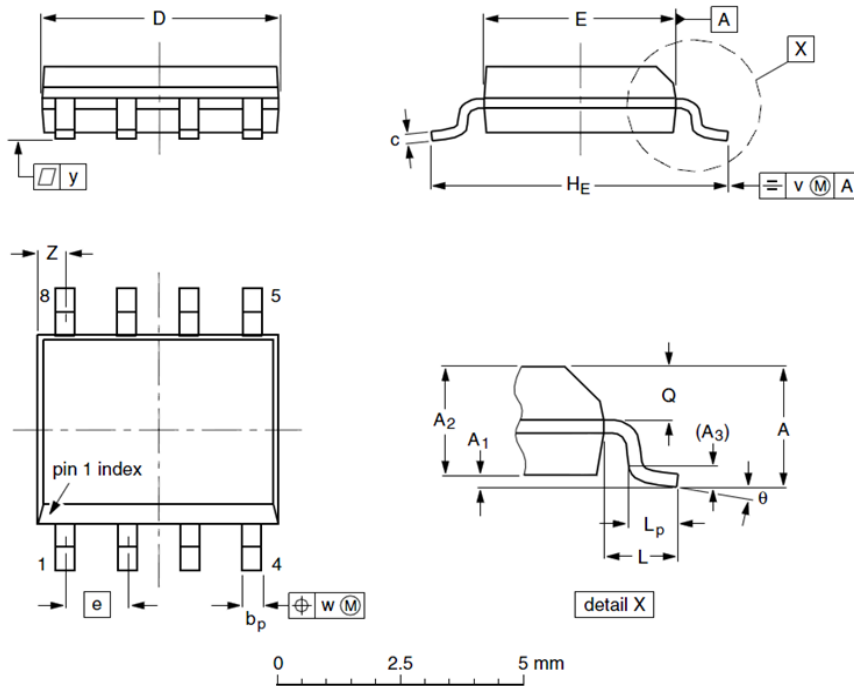

Label	Dimensions (unit: mm)		
	Min	Typ	Max
A	--	--	1.75
A <sub>1</sub>	0.10	0.18	0.25
A <sub>2</sub>	1.25	1.35	1.50
A <sub>3</sub>	--	0.25	--
b <sub>p</sub>	0.36	0.42	0.51
c	0.19	0.22	0.25
D	4.80	4.92	5.00
E	3.80	3.90	4.00
e	--	1.27	--
H <sub>E</sub>	5.80	6.00	6.20
L	--	1.05	--
L <sub>p</sub>	0.40	0.68	1.00
Q	0.60	0.65	0.725
v	--	0.25	--
w	--	0.25	--
y	--	0.10	--
Z	0.30	0.50	0.70
θ	0°		8°

### Notes:

1. Follow JEDEC MS-012.
2. Dimension "D" does NOT include mold flash, protrusions or gate burrs. Mold flash, protrusions or gate burrs shall not exceed 0.15mm per side.
3. Dimension "E" does NOT include interlead flash or protrusion. Interlead flash or protrusion shall not exceed 0.25mm per side.
4. Dimension "b<sub>p</sub>" does NOT include dambar protrusion. Allowable dambar protrusion shall be 0.1mm total in excess of "b<sub>p</sub>" dimension at maximum material condition. The dambar cannot be located on the lower radius of the foot.

## Customer Service

### Sales and Service:

[sales@vgsemi.com](mailto:sales@vgsemi.com)

**Vanguard Semiconductor CO., LTD**

**TEL:** (86-755) -26902410

**FAX:** (86-755) -26907027

**WEB:** [www.vgsemi.com](http://www.vgsemi.com)