

Features

- N-Channel
- Enhancement mode
- Very low on-resistance $R_{DS(on)}$ @ $V_{GS}=4.5\text{ V}$
- Fast Switching
- High conversion efficiency
- Pb-free lead plating; RoHS compliant



V_{DS}	80	V
$R_{DS(on),TYP}@ V_{GS}=10\text{ V}$	9	m Ω
$R_{DS(on),TYP}@ V_{GS}=4.5\text{ V}$	11	m Ω
I_D	66	A

PDFN5X6



Part ID	Package Type	Marking	Tape and reel information
VSP013N08MS	PDFN5X6	013N08M	3000pcs/Reel

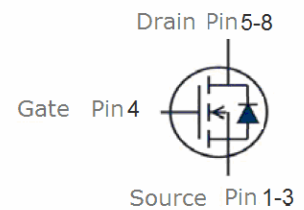

Maximum ratings, at $T_j=25\text{ }^\circ\text{C}$, unless otherwise specified

Symbol	Parameter	Rating	Unit
$V_{(BR)DSS}$	Drain-Source breakdown voltage	80	V
I_S	Diode continuous forward current	$T_C=25\text{ }^\circ\text{C}$	60 A
I_D	Continuous drain current @ $V_{GS}=10\text{ V}$	$T_C=25\text{ }^\circ\text{C}$	66 A
		$T_A=70\text{ }^\circ\text{C}$	43 A
I_{DM}	Pulse drain current tested ①	$T_C=25\text{ }^\circ\text{C}$	180 A
EAS	Avalanche energy, single pulsed ②	$I_D=16\text{ A}$	225 mJ
P_D	Maximum power dissipation	$T_A=25\text{ }^\circ\text{C}$	83 W
V_{GS}	Gate-Source voltage	± 20	V
$T_{STG} T_J$	Storage and operating temperature range	-55 to 175	$^\circ\text{C}$

Thermal Characteristics

Symbol	Parameter	Typical	Unit
$R_{\theta JC}$	Thermal Resistance-Junction to Case	1.8	$^\circ\text{C/W}$
$R_{\theta JA}$	Thermal Resistance Junction-Ambient	50	$^\circ\text{C/W}$

Symbol	Parameter	Condition	Min.	Typ.	Max.	Unit
Static Electrical Characteristics @ T_c = 25°C (unless otherwise stated)						
V _{(BR)DSS}	Drain-Source Breakdown Voltage	V _{GS} =0V, I _D =250μA	80	--	--	V
I _{DSS}	Zero Gate Voltage Drain Current(T _c =25°C)	V _{DS} =80V, V _{GS} =0V	--	--	1	μA
	Zero Gate Voltage Drain Current(T _c =125°C)	V _{DS} =80V, V _{GS} =0V	--	--	100	μA
I _{GSS}	Gate-Body Leakage Current	V _{GS} =±20V, V _{DS} =0V	--	--	±100	nA
V _{GS(TH)}	Gate Threshold Voltage	V _{DS} =V _{GS} , I _D =250μA	1.0	2.0	3.0	V
R _{DS(ON)}	Drain-Source On-State Resistance ^③	V _{GS} =10V, I _D =25A	--	9	13	mΩ
R _{DS(ON)}	Drain-Source On-State Resistance ^③	V _{GS} =4.5V, I _D =10A	--	11	16	mΩ
Dynamic Electrical Characteristics @ T_c = 25°C (unless otherwise stated)						
C _{iss}	Input Capacitance	V _{DS} =20V, V _{GS} =0V, f=1MHz	--	4080	--	pF
C _{oss}	Output Capacitance		--	195	--	pF
C _{rss}	Reverse Transfer Capacitance		--	130	--	pF
Q _g	Total Gate Charge	V _{DS} =50V, I _D =4A, V _{GS} =10V	--	80	--	nC
Q _{gs}	Gate-Source Charge		--	10	--	nC
Q _{gd}	Gate-Drain Charge		--	14	--	nC
Switching Characteristics						
t _{d(on)}	Turn-on Delay Time	V _{DD} =50V, I _D =4A, R _G =6.8Ω, V _{GS} =10V	--	24	--	nS
t _r	Turn-on Rise Time		--	112	--	nS
t _{d(off)}	Turn-Off Delay Time		--	51	--	nS
t _f	Turn-Off Fall Time		--	105	--	nS
Source- Drain Diode Characteristics @ T_c = 25°C (unless otherwise stated)						
V _{SD}	Forward on voltage	I _{SD} =25A, V _{GS} =0V	--	0.85	1.2	V
t _{rr}	Reverse Recovery Time	T _j =25°C, I _{sd} =4A, V _{GS} =0V	--	33	--	nS
Q _{rr}	Reverse Recovery Charge	di/dt=100A/μs		42		nC

NOTE:

- ① Repetitive rating; pulse width limited by max. junction temperature.
- ② Limited by T_{jmax}, starting T_J = 25°C, L = 0.5mH, R_G = 25Ω, I_{AS} = 16A, V_{GS} = 10V. Part not recommended for use above this value
- ③ Pulse width ≤ 300μs; duty cycle ≤ 2%.

Typical Characteristics

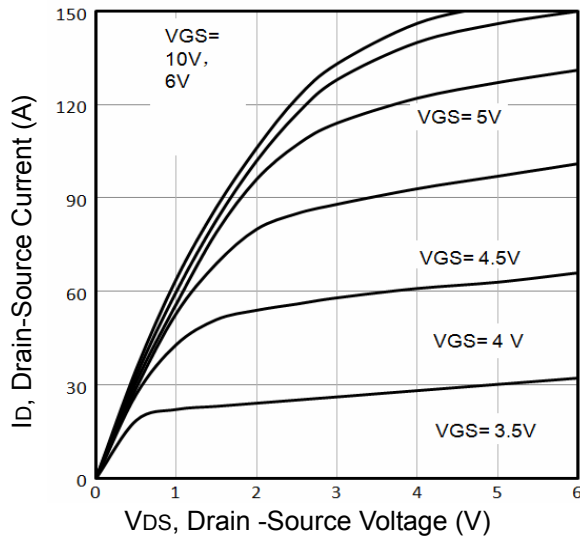

Fig1. Typical Output Characteristics

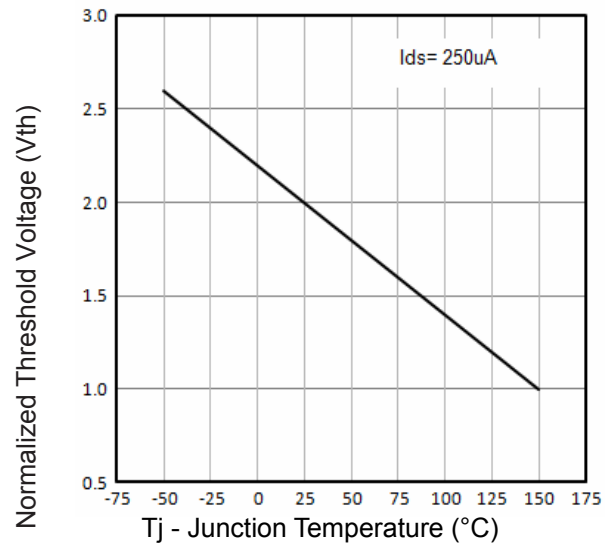

Fig2. Normalized Threshold Voltage Vs.

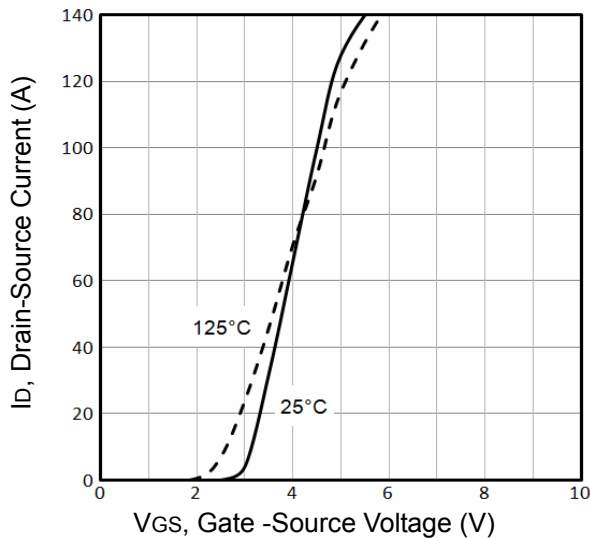

Fig3. Typical Transfer Characteristics

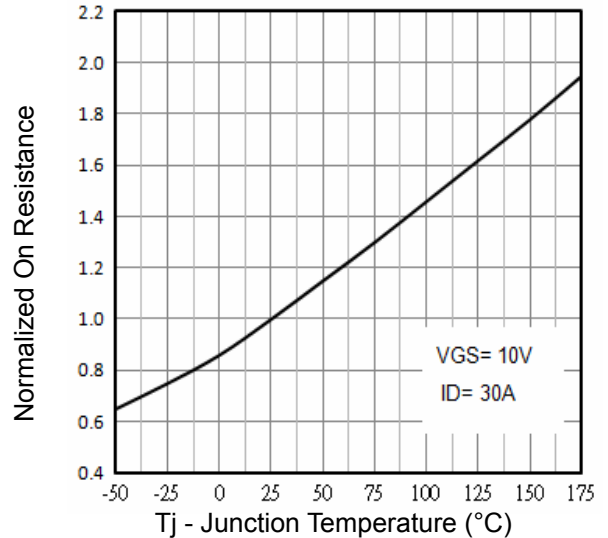

Fig4. Normalized On-Resistance Vs. Temperature

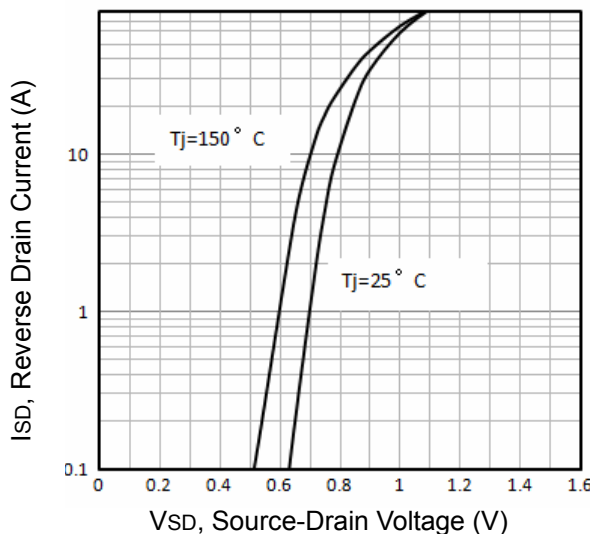

Fig5. Typical Source-Drain Diode Forward Voltage

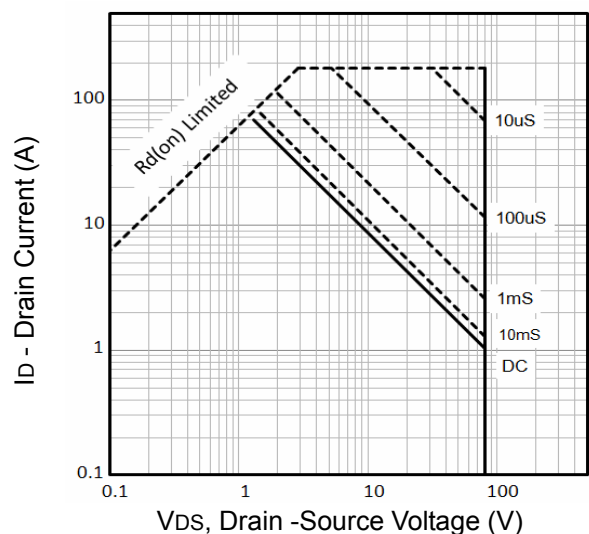

Fig6. Maximum Safe Operating Area

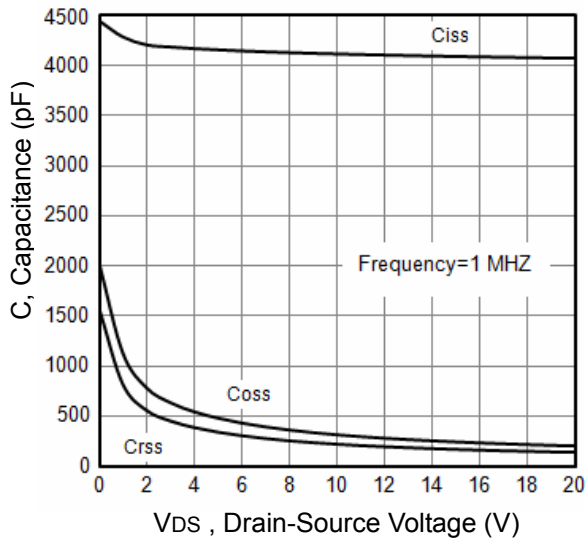

Fig7. Typical Capacitance Vs.Drain-Source Voltage

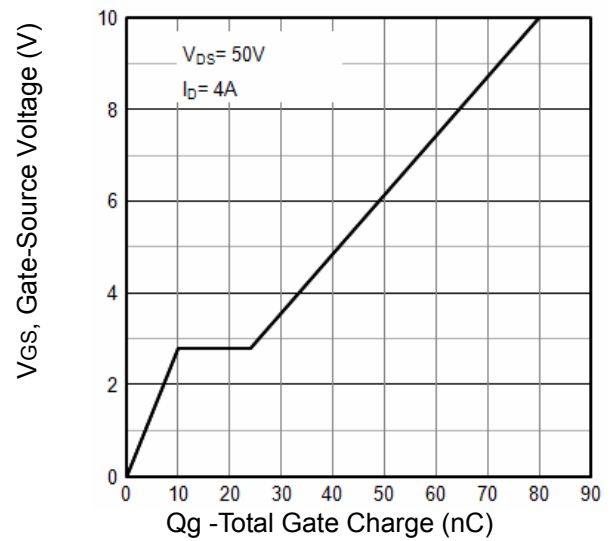

Fig8. Typical Gate Charge Vs.Gate-Source Voltage

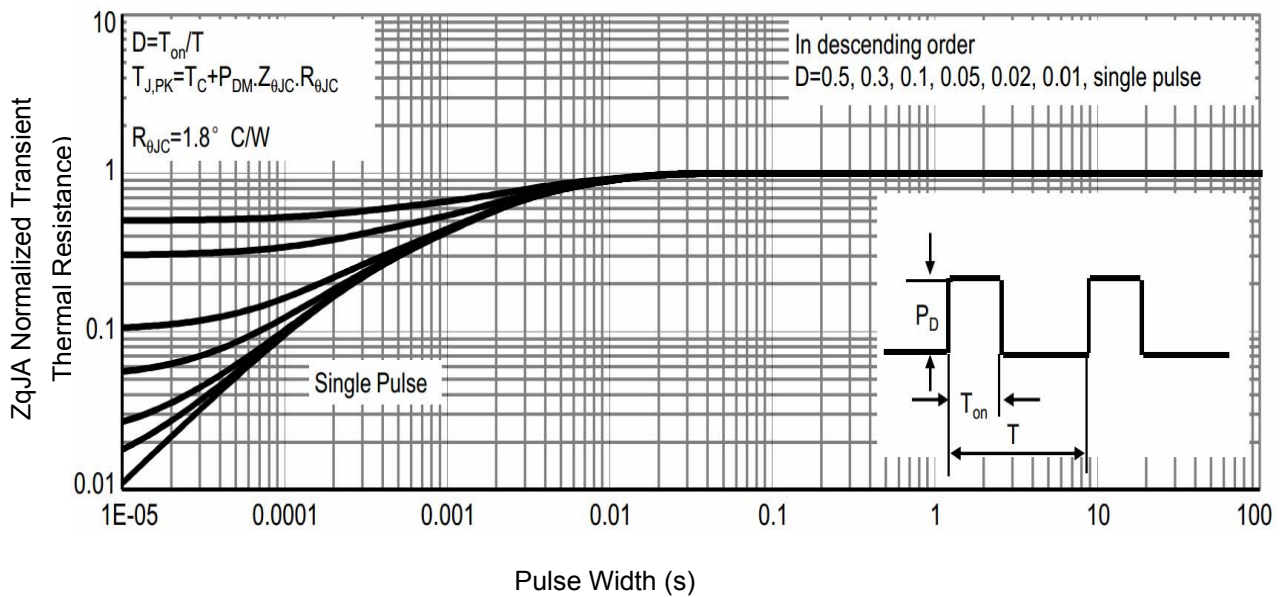

Figure 9: Normalized Maximum Transient Thermal Impedance

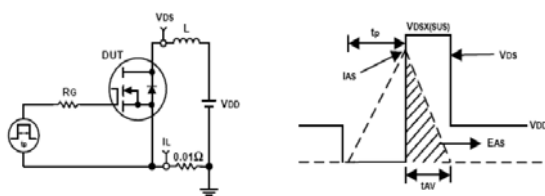

Fig10. Unclamped Inductive Test Circuit and waveforms

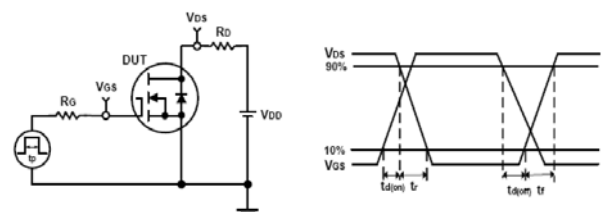
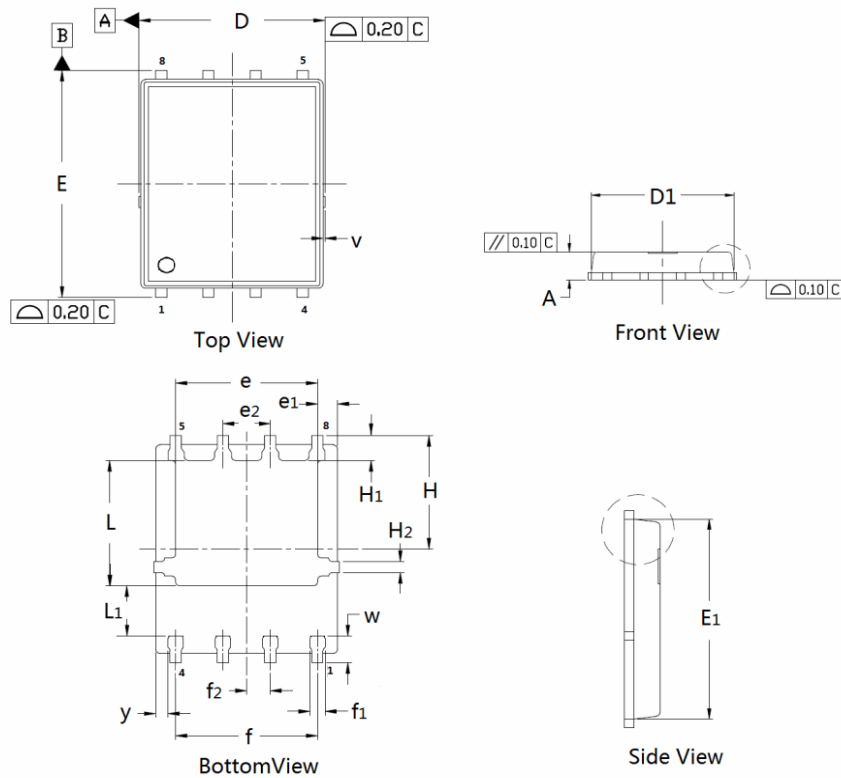

Fig11. Switching Time Test Circuit and waveforms

PDFN5×6 Package Outline Data



DIMENSIONS (unit : mm)

Symbol	Min	Typ	Max	Symbol	Min	Typ	Max
A	0.90	1.02	1.10	D	4.90	4.98	5.10
D ₁	4.80	4.89	5.00	E	6.00	6.11	6.20
E ₁	5.65	5.74	5.85	e	3.72	3.80	3.92
e ₁	--	0.54	--	e ₂	--	1.27	--
f	--	3.82	--	f ₁	0.31	0.37	0.51
f ₂	--	0.64	--	H	--	3.15	--
H ₁	0.59	0.63	0.79	H ₂	0.26	0.28	0.32
L	3.38	3.45	3.58	L ₁	--	1.39	--
v	--	0.13	--	w	0.64	0.68	0.84
y	--	0.34	--		--		--

Customer Service

Sales and Service:

sales@vgsemi.com

Vanguard Semiconductor CO., LTD

TEL: (86-755) -26902410

FAX: (86-755) -26907027

WEB: www.vgsemi.com