

## Features

- N-Channel
- Enhancement mode
- Very low on-resistance  $R_{DS(on)}$  @  $V_{GS}=4.5\text{ V}$
- Fast Switching
- 100% Avalanche test
- Pb-free lead plating; RoHS compliant



Part ID	Package Type	Marking	Tape and reel information
VSP013N10MS	PDFN5x6	013N10M	3000PCS/Reel

$V_{DS}$	100	V
$R_{DS(on),TYP}@ V_{GS}=10\text{ V}$	11	m $\Omega$
$R_{DS(on),TYP}@ V_{GS}=4.5\text{ V}$	12	m $\Omega$
$I_D$	52	A

### PDFN5x6

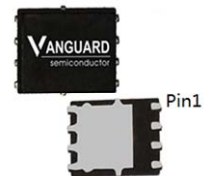

Drain Pin5-8



Source Pin 1-3

## Maximum ratings, at $T_j=25^\circ\text{C}$ , unless otherwise specified

Symbol	Parameter	Rating	Unit	
$V_{(BR)DSS}$	Drain-Source breakdown voltage	100	V	
$I_S$	Diode continuous forward current	$T_C=25^\circ\text{C}$	52	A
$I_D$	Continuous drain current@ $V_{GS}=10\text{V}$	$T_C=25^\circ\text{C}$	52	A
		$T_A=100^\circ\text{C}$	33	A
$I_{DM}$	Pulse drain current tested ①	$T_C=25^\circ\text{C}$	150	A
EAS	Avalanche energy, single pulsed ②	$I_D=18\text{A}$	60	mJ
IAS	Avalanche energy, single pulsed ②		20	A
$P_D$	Maximum power dissipation	$T_A=25^\circ\text{C}$	78	W
$V_{GS}$	Gate-Source voltage	$\pm 20$	V	
$T_{STG} T_J$	Storage and operating temperature range	-55 to 175	$^\circ\text{C}$	

## Thermal Characteristics

Symbol	Parameter	Typical	Unit
$R_{\theta JC}$	Thermal Resistance-Junction to Case	1.9	$^\circ\text{C/W}$
$R_{\theta JA}$	Thermal Resistance Junction-Ambient	60	$^\circ\text{C/W}$

Symbol	Parameter	Condition	Min.	Typ.	Max.	Unit
<b>Static Electrical Characteristics @ T<sub>c</sub> = 25°C (unless otherwise stated)</b>						
V <sub>(BR)DSS</sub>	Drain-Source Breakdown Voltage	V <sub>GS</sub> =0V I <sub>D</sub> =250μA	100	--	--	V
I <sub>DSS</sub>	Zero Gate Voltage Drain Current(T <sub>c</sub> =25°C)	V <sub>DS</sub> =100V, V <sub>GS</sub> =0V	--	--	1	μA
	Zero Gate Voltage Drain Current(T <sub>c</sub> =125°C)	V <sub>DS</sub> =100V, V <sub>GS</sub> =0V	--	--	100	μA
I <sub>GSS</sub>	Gate-Body Leakage Current	V <sub>GS</sub> =±20V, V <sub>DS</sub> =0V	--	--	±100	nA
V <sub>GS(TH)</sub>	Gate Threshold Voltage	V <sub>DS</sub> =V <sub>GS</sub> , I <sub>D</sub> =250μA	1.0	2.0	3.0	V
R <sub>DS(ON)</sub>	Drain-Source On-State Resistance <sup>③</sup>	V <sub>GS</sub> =10V, I <sub>D</sub> =25A	--	11	13	mΩ
R <sub>DS(ON)</sub>	Drain-Source On-State Resistance <sup>③</sup>	V <sub>GS</sub> =4.5V, I <sub>D</sub> =5A	--	12	15	mΩ
<b>Dynamic Electrical Characteristics @ T<sub>c</sub> = 25°C (unless otherwise stated)</b>						
C <sub>iss</sub>	Input Capacitance	V <sub>DS</sub> =20V, V <sub>GS</sub> =0V, f=1MHz	--	3625	--	pF
C <sub>oss</sub>	Output Capacitance		--	225	--	pF
C <sub>rss</sub>	Reverse Transfer Capacitance		--	140	--	pF
Q <sub>g</sub>	Total Gate Charge	V <sub>DS</sub> =50V, I <sub>D</sub> =4A, V <sub>GS</sub> =10V	--	83	--	nC
Q <sub>gs</sub>	Gate-Source Charge		--	12	--	nC
Q <sub>gd</sub>	Gate-Drain Charge		--	16.5	--	nC
<b>Switching Characteristics</b>						
t <sub>d(on)</sub>	Turn-on Delay Time	V <sub>DD</sub> =50V, I <sub>D</sub> =4A, R <sub>G</sub> =6.8Ω, V <sub>GS</sub> =10V	--	23	--	nS
t <sub>r</sub>	Turn-on Rise Time		--	112	--	nS
t <sub>d(off)</sub>	Turn-Off Delay Time		--	50	--	nS
t <sub>f</sub>	Turn-Off Fall Time		--	100	--	nS
<b>Source- Drain Diode Characteristics @ T<sub>c</sub> = 25°C (unless otherwise stated)</b>						
V <sub>SD</sub>	Forward on voltage	I <sub>SD</sub> =25A, V <sub>GS</sub> =0V	--	0.83	1.20	V
t <sub>rr</sub>	Reverse Recovery Time	T <sub>j</sub> =25°C, I <sub>sd</sub> =4A, V <sub>GS</sub> =0V	--	33	--	nS
Q <sub>rr</sub>	Reverse Recovery Charge	di/dt=100A/μs		42		nC

**NOTE:**

- ① Repetitive rating; pulse width limited by max. junction temperature.
- ② Limited by T<sub>jmax</sub>, starting T<sub>J</sub> = 25°C, L = 0.3mH, R<sub>G</sub> = 25Ω, I<sub>AS</sub> = 20A, V<sub>GS</sub> = 10V. Part not recommended for use above this value
- ③ Pulse width ≤ 300μs; duty cycle ≤ 2%.

Typical Characteristics

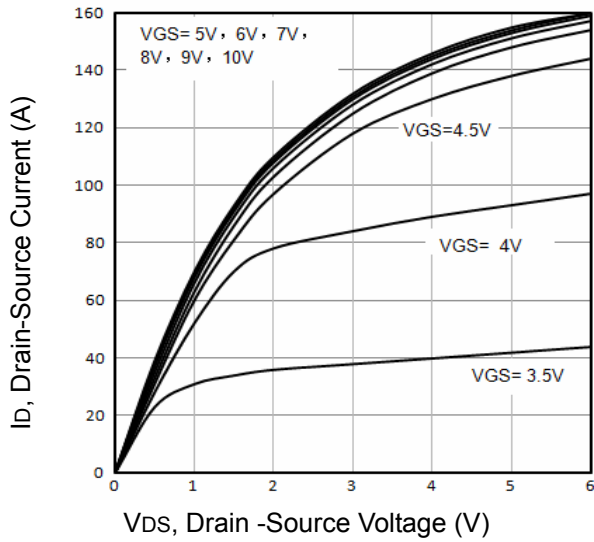

Fig1. Typical Output Characteristics

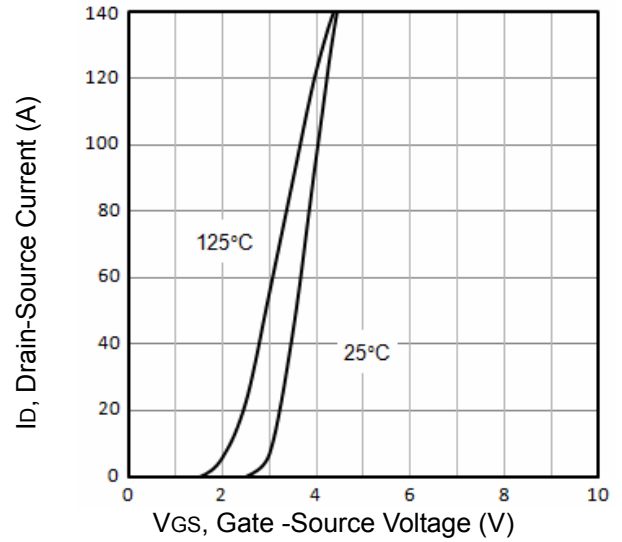

Fig2. Typical Transfer Characteristics

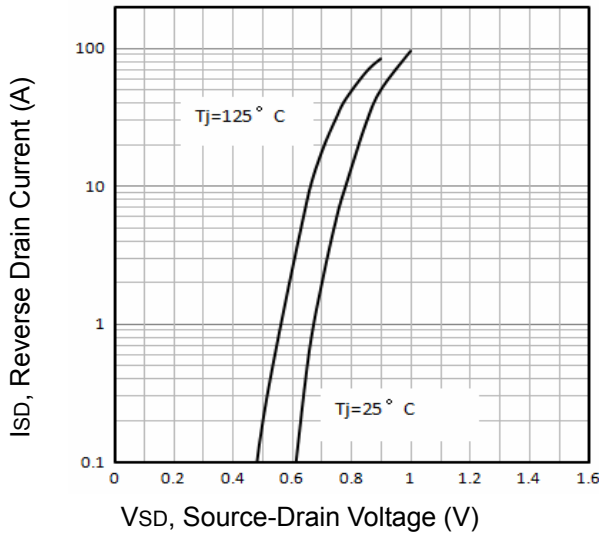

Fig3. Typical Source-Drain Diode Forward

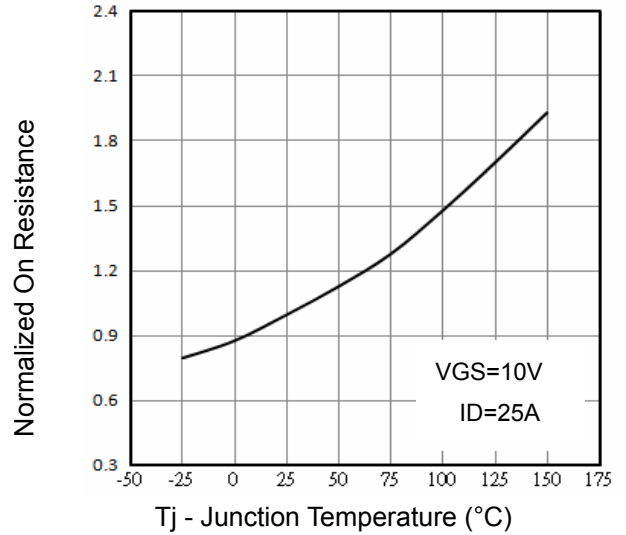

Fig4. Normalized On-Resistance Vs. Temperature

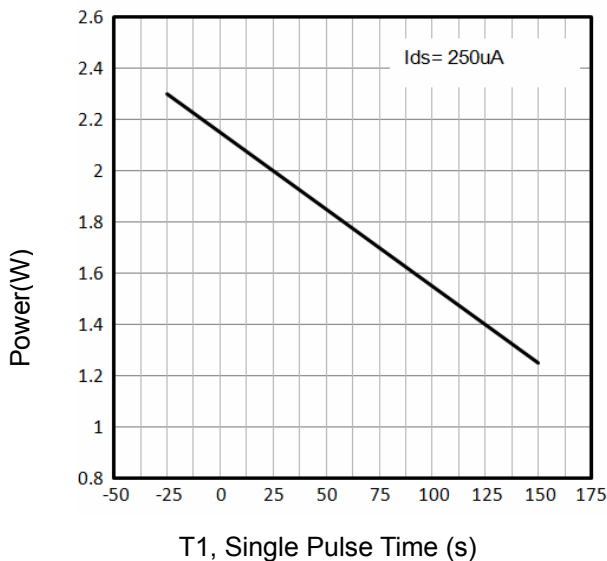

Fig5. Single Pulse Maximum Power Dissipation

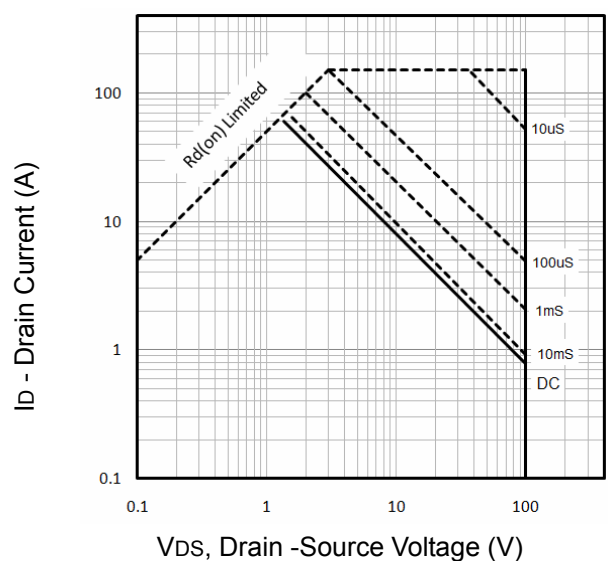

Fig6. Maximum Safe Operating Area

**Typical Characteristics**

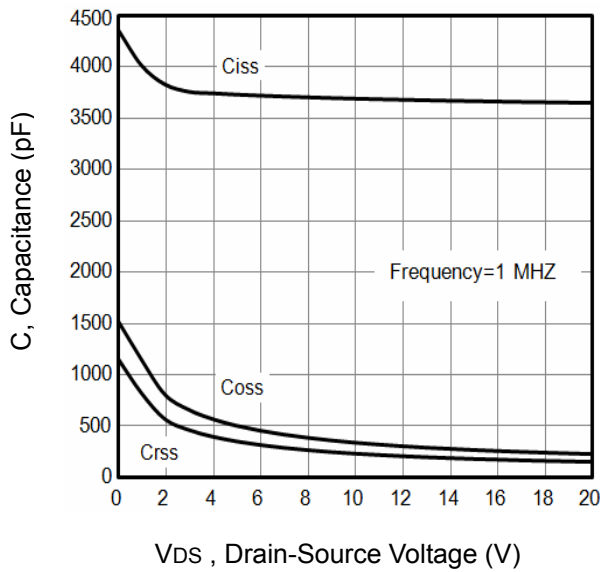

Fig7. Typical Capacitance Vs.Drain-Source Voltage

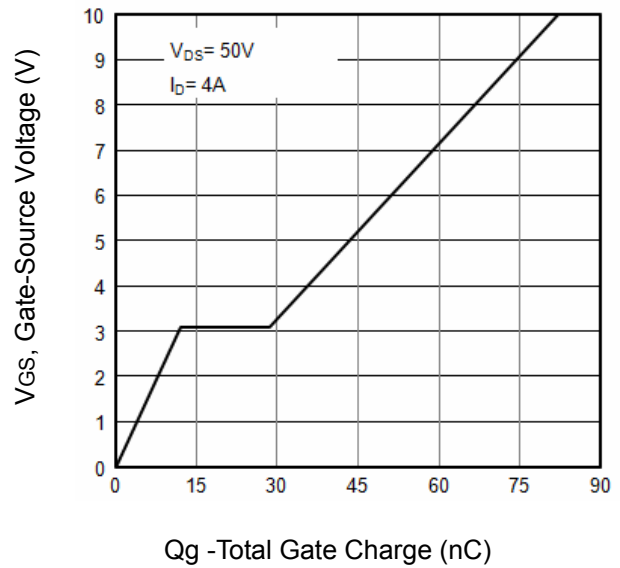

Fig8. Typical Gate Charge Vs.Gate-Source Voltage

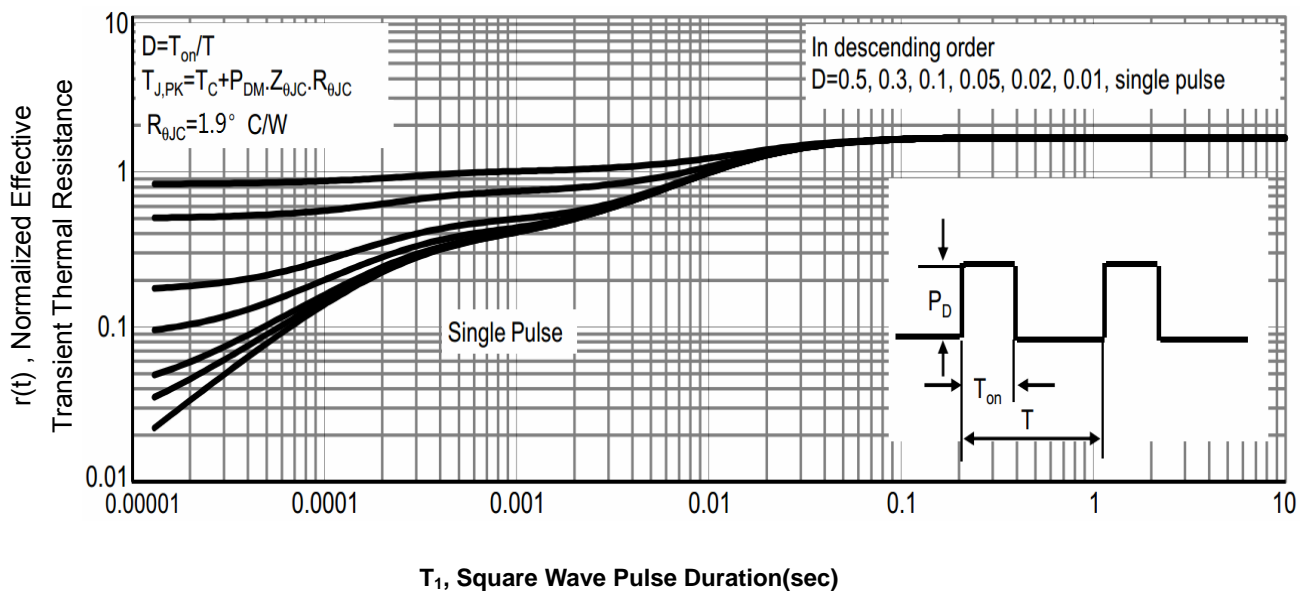

Fig9. T1, Transient Thermal Response Curve

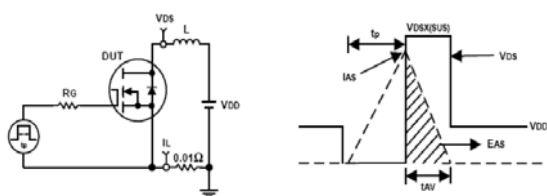

Fig10. Unclamped Inductive Test Circuit and waveforms

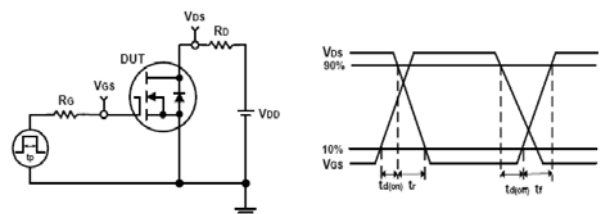
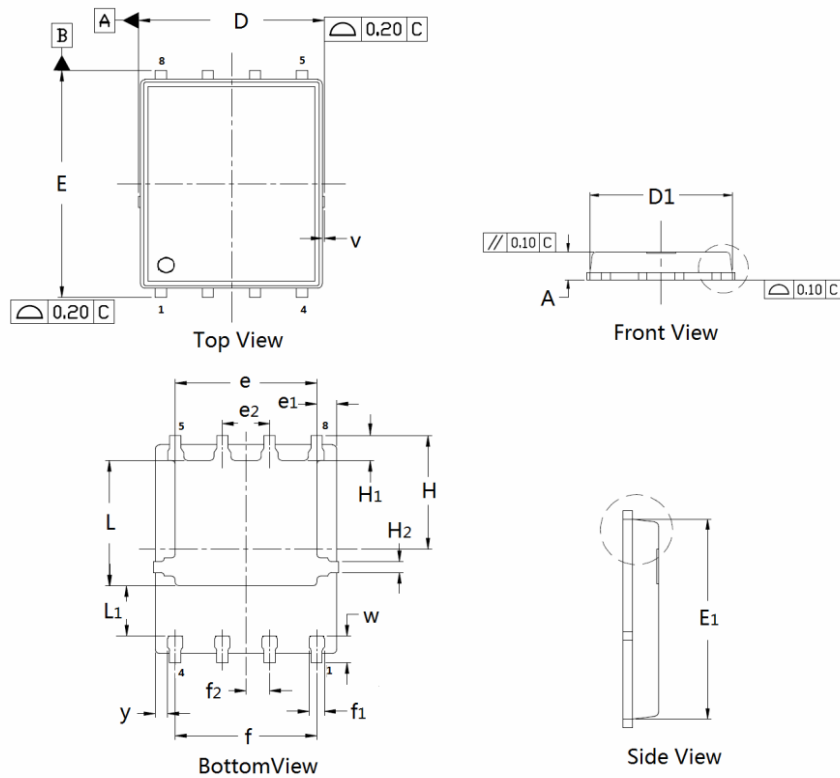

Fig11. Switching Time Test Circuit and waveforms

PDFN5×6 Package Outline Data



DIMENSIONS ( unit : mm )

Symbol	Min	Typ	Max	Symbol	Min	Typ	Max
A	0.90	1.02	1.10	D	4.90	4.98	5.10
D <sub>1</sub>	4.80	4.89	5.00	E	6.00	6.11	6.20
E <sub>1</sub>	5.65	5.74	5.85	e	3.72	3.80	3.92
e <sub>1</sub>	--	0.54	--	e <sub>2</sub>	--	1.27	--
f	--	3.82	--	f <sub>1</sub>	0.31	0.37	0.51
f <sub>2</sub>	--	0.64	--	H	--	3.15	--
H <sub>1</sub>	0.59	0.63	0.79	H <sub>2</sub>	0.26	0.28	0.32
L	3.38	3.45	3.58	L <sub>1</sub>	--	1.39	--
v	--	0.13	--	w	0.64	0.68	0.84
y	--	0.34	--		--		--

Customer Service

Sales and Service:

[sales@vgsemi.com](mailto:sales@vgsemi.com)

Vanguard Semiconductor CO., LTD

TEL: (86-755) -26902410

FAX: (86-755) -26907027

WEB: [www.vgsemi.com](http://www.vgsemi.com)