

## Features

- N-Channel, 5V Logic Level Control
- Enhancement mode
- Low on-resistance  $R_{DS(on)}$  @  $V_{GS}=4.5\text{ V}$
- VitoMOS<sup>®</sup> Technology
- 100% Avalanche Tested
- Pb-free lead plating; RoHS compliant



Part ID	Package Type	Marking	Tape and reel information
VST007N07MS	TO-220AB	007N07M	50pcs/Tube

$V_{DS}$	80	V
$R_{DS(on),TYP} @ V_{GS}=10\text{ V}$	8	m $\Omega$
$R_{DS(on),TYP} @ V_{GS}=4.5\text{ V}$	9	m $\Omega$
$I_D$	80	A

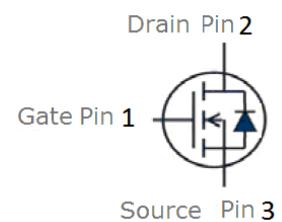
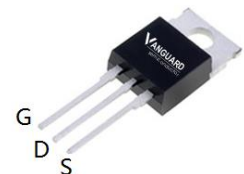
**TO-220AB**

## Maximum ratings, at $T_A=25\text{ }^\circ\text{C}$ , unless otherwise specified

Symbol	Parameter	Rating	Unit
$V_{(BR)DSS}$	Drain-Source breakdown voltage	80	V
$V_{GS}$	Gate-Source voltage	$\pm 20$	V
$I_S$	Diode continuous forward current	$T_C=25\text{ }^\circ\text{C}$	80 A
$I_D$	Continuous drain current @ $V_{GS}=10\text{ V}$	$T_C=25\text{ }^\circ\text{C}$	80 A
		$T_C=100\text{ }^\circ\text{C}$	57 A
$I_{DM}$	Pulse drain current tested ①	$T_C=25\text{ }^\circ\text{C}$	320 A
$I_{DSM}$	Continuous drain current @ $V_{GS}=10\text{ V}$	$T_A=25\text{ }^\circ\text{C}$	10 A
		$T_A=70\text{ }^\circ\text{C}$	8 A
EAS	Avalanche energy, single pulsed ②	132	mJ
$P_D$	Maximum power dissipation	$T_C=25\text{ }^\circ\text{C}$	120 W
$P_{DSM}$	Maximum power dissipation ③	$T_A=25\text{ }^\circ\text{C}$	2 W
$T_{STG}, T_J$	Storage and Junction Temperature Range	-55 to 175	$^\circ\text{C}$

## Thermal Characteristics

Symbol	Parameter	Typical	Unit
$R_{\theta JC}$	Thermal Resistance, Junction-to-Case	1.25	$^\circ\text{C/W}$
$R_{\theta JA}$	Thermal Resistance, Junction-to-Ambient	62.5	$^\circ\text{C/W}$



### Typical Characteristics

Symbol	Parameter	Condition	Min.	Typ.	Max.	Unit
<b>Static Electrical Characteristics @ T<sub>j</sub> = 25°C (unless otherwise stated)</b>						
V <sub>(BR)DSS</sub>	Drain-Source Breakdown Voltage	V <sub>GS</sub> =0V, I <sub>D</sub> =250μA	80	--	--	V
I <sub>DSS</sub>	Zero Gate Voltage Drain Current(T <sub>j</sub> =25°C)	V <sub>DS</sub> =80V, V <sub>GS</sub> =0V	--	--	1	μA
	Zero Gate Voltage Drain Current(T <sub>j</sub> =125°C)	V <sub>DS</sub> =80V, V <sub>GS</sub> =0V	--	--	100	μA
I <sub>GSS</sub>	Gate-Body Leakage Current	V <sub>GS</sub> =±20V, V <sub>DS</sub> =0V	--	--	±100	nA
V <sub>GS(TH)</sub>	Gate Threshold Voltage	V <sub>DS</sub> =V <sub>GS</sub> , I <sub>D</sub> =250μA	1.3	--	2.3	V
R <sub>DS(ON)</sub>	Drain-Source On-State Resistance ④	V <sub>GS</sub> =10V, I <sub>D</sub> =40A	--	8	11	mΩ
R <sub>DS(ON)</sub>	Drain-Source On-State Resistance ④	V <sub>GS</sub> =4.5V, I <sub>D</sub> =20A	--	9	12	mΩ
<b>Dynamic Electrical Characteristics @ T<sub>j</sub> = 25°C (unless otherwise stated)</b>						
C <sub>iss</sub>	Input Capacitance	V <sub>DS</sub> =30V, V <sub>GS</sub> =0V, f=1MHz	3500	4420	5300	pF
C <sub>oss</sub>	Output Capacitance		100	225	350	pF
C <sub>rss</sub>	Reverse Transfer Capacitance		90	195	300	pF
R <sub>g</sub>	Gate Resistance	f=1MHz	--	3.4	--	Ω
Q <sub>g</sub>	Total Gate Charge	V <sub>DS</sub> =40V, I <sub>D</sub> =40A, V <sub>GS</sub> =10V	--	71	--	nC
Q <sub>gs</sub>	Gate-Source Charge		--	22	--	nC
Q <sub>gd</sub>	Gate-Drain Charge		--	24	--	nC
<b>Switching Characteristics</b>						
t <sub>d(on)</sub>	Turn-on Delay Time	V <sub>DD</sub> =40V, I <sub>D</sub> =40A, R <sub>G</sub> =3Ω, V <sub>GS</sub> =10V	--	23	--	ns
t <sub>r</sub>	Turn-on Rise Time		--	17	--	ns
t <sub>d(off)</sub>	Turn-Off Delay Time		--	40	--	ns
t <sub>f</sub>	Turn-Off Fall Time		--	14	--	ns
<b>Source- Drain Diode Characteristics @ T<sub>j</sub> = 25°C (unless otherwise stated)</b>						
V <sub>SD</sub>	Forward on voltage	I <sub>SD</sub> =40A, V <sub>GS</sub> =0V	--	0.8	1.2	V
t <sub>rr</sub>	Reverse Recovery Time	T <sub>j</sub> =25°C, I <sub>sd</sub> =40A, V <sub>GS</sub> =0V	--	29	--	ns
Q <sub>rr</sub>	Reverse Recovery Charge	di/dt=500A/μs	--	131	--	nC

NOTE:

- ① Repetitive rating; pulse width limited by max junction temperature.
- ② Limited by T<sub>Jmax</sub>, starting T<sub>J</sub> = 25°C, L = 0.5mH, R<sub>G</sub> = 25Ω, I<sub>AS</sub> = 18A, V<sub>GS</sub> = 10V. Part not recommended for use above this value
- ③ The power dissipation P<sub>DSM</sub> is based on R<sub>θJA</sub> and the maximum allowed junction temperature of 150°C.
- ④ Pulse width ≤ 300μs; duty cycle ≤ 2%.



### Typical Characteristics

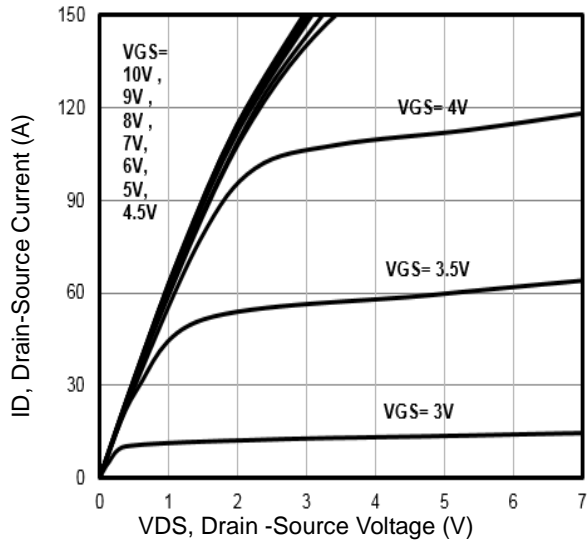

Fig1. Typical Output Characteristics

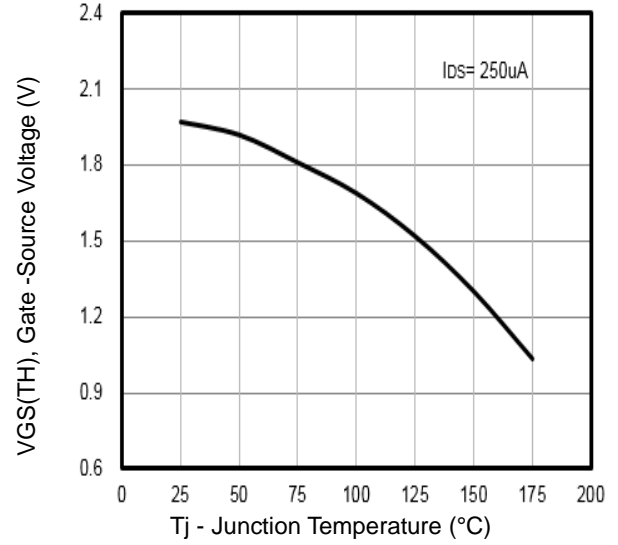

Fig2. VGS(TH) Gate-Source Voltage Vs. Tj

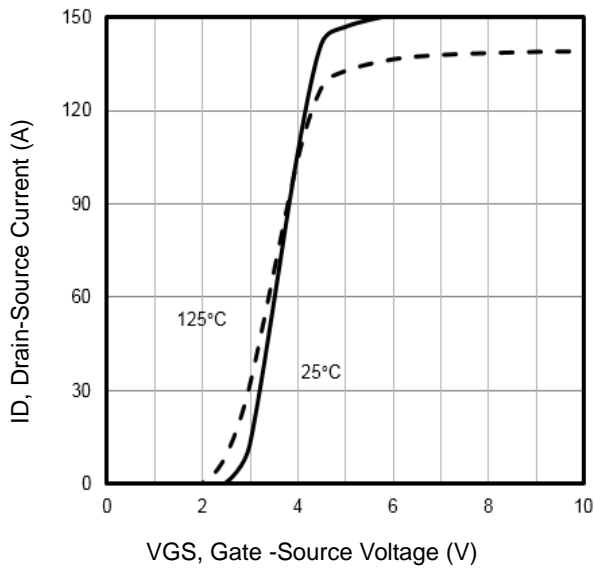

Fig3. Typical Transfer Characteristics

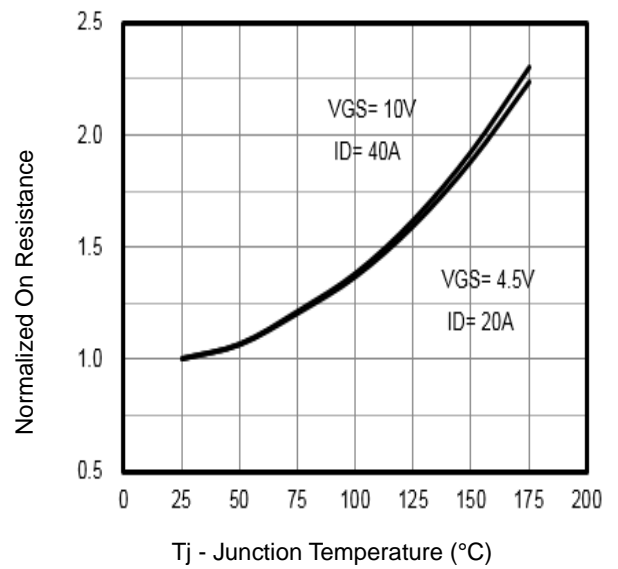

Fig4. Normalized On-Resistance Vs. Temperature

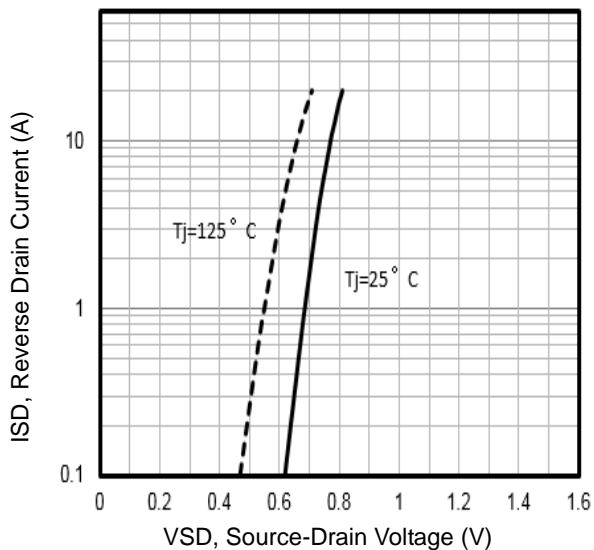

Fig5. Typical Source-Drain Diode Forward Voltage

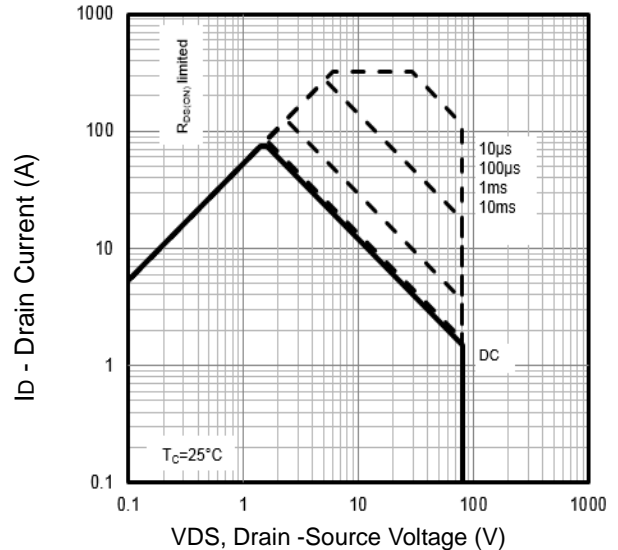

Fig6. Maximum Safe Operating Area

Typical Characteristics

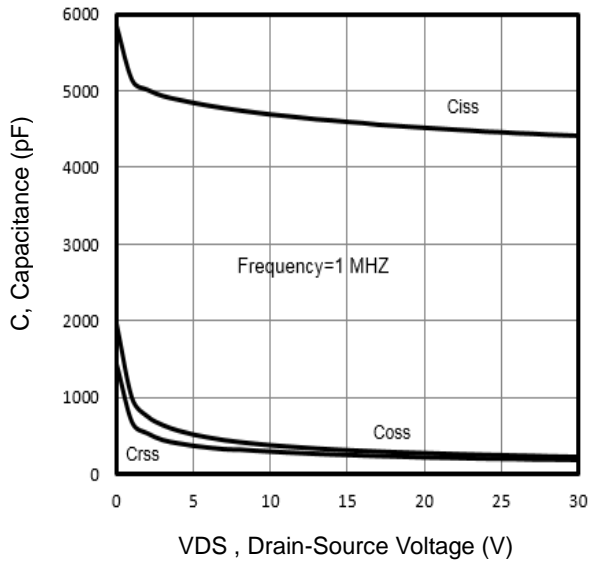

Fig7. Typical Capacitance Vs.Drain-Source Voltage

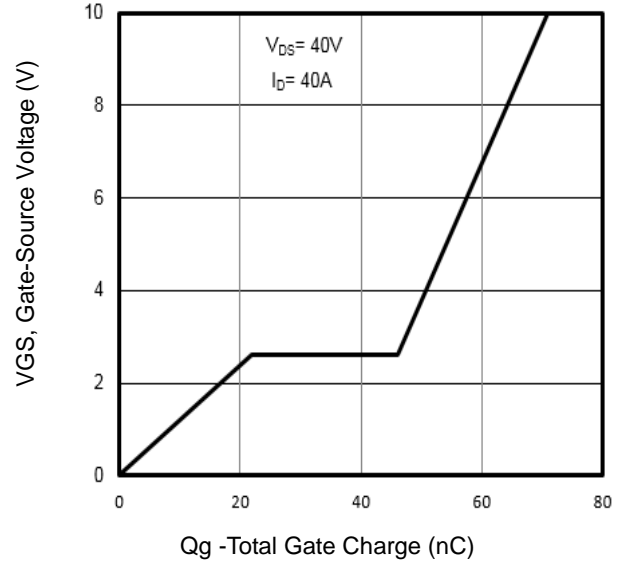

Fig8. Typical Gate Charge Vs.Gate-Source Voltage

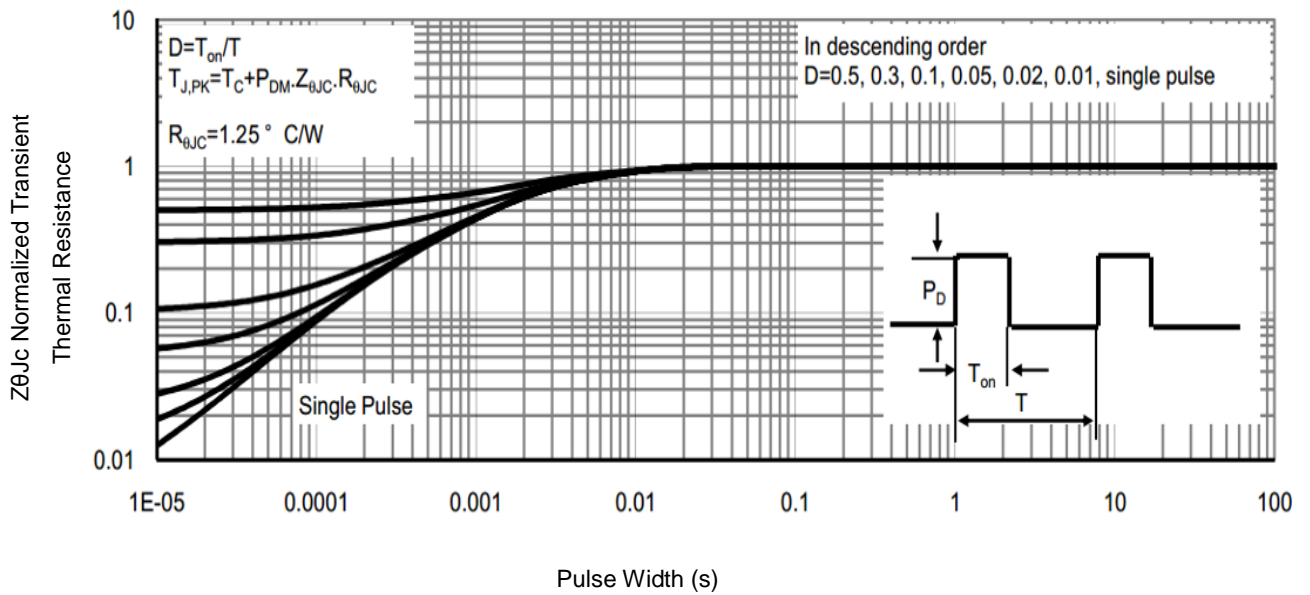

Fig9. Normalized Maximum Transient Thermal Impedance

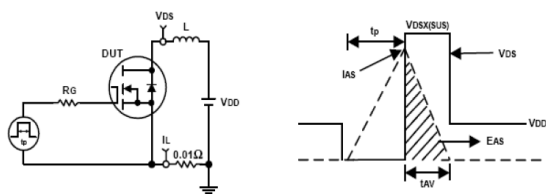

Fig10. Unclamped Inductive Test Circuit and waveforms

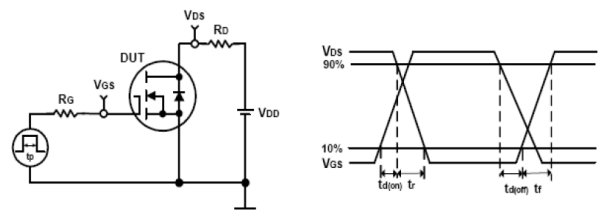
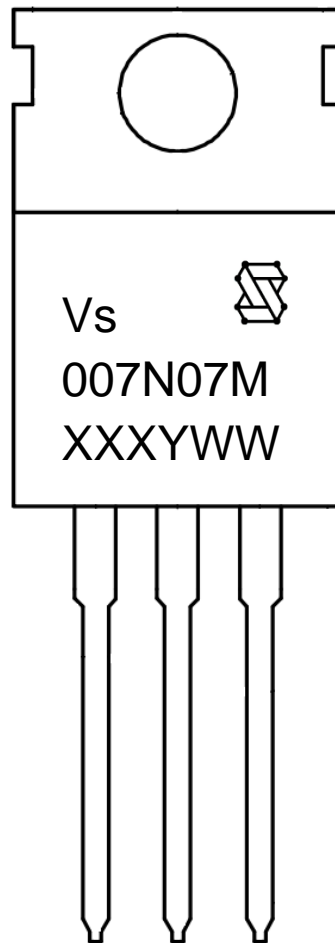

Fig11. Switching Time Test Circuit and waveforms



## Marking Information



1st line: Vanguard Code (Vs), Vanguard Logo

2nd line: Part Number (007N07M)

3rd line: Date code (XXXYWW)

XXX: Wafer Lot Number

Y: Year Code, e.g. E means 2017

WW: Week Code



## TO-220AB Package Outline Data

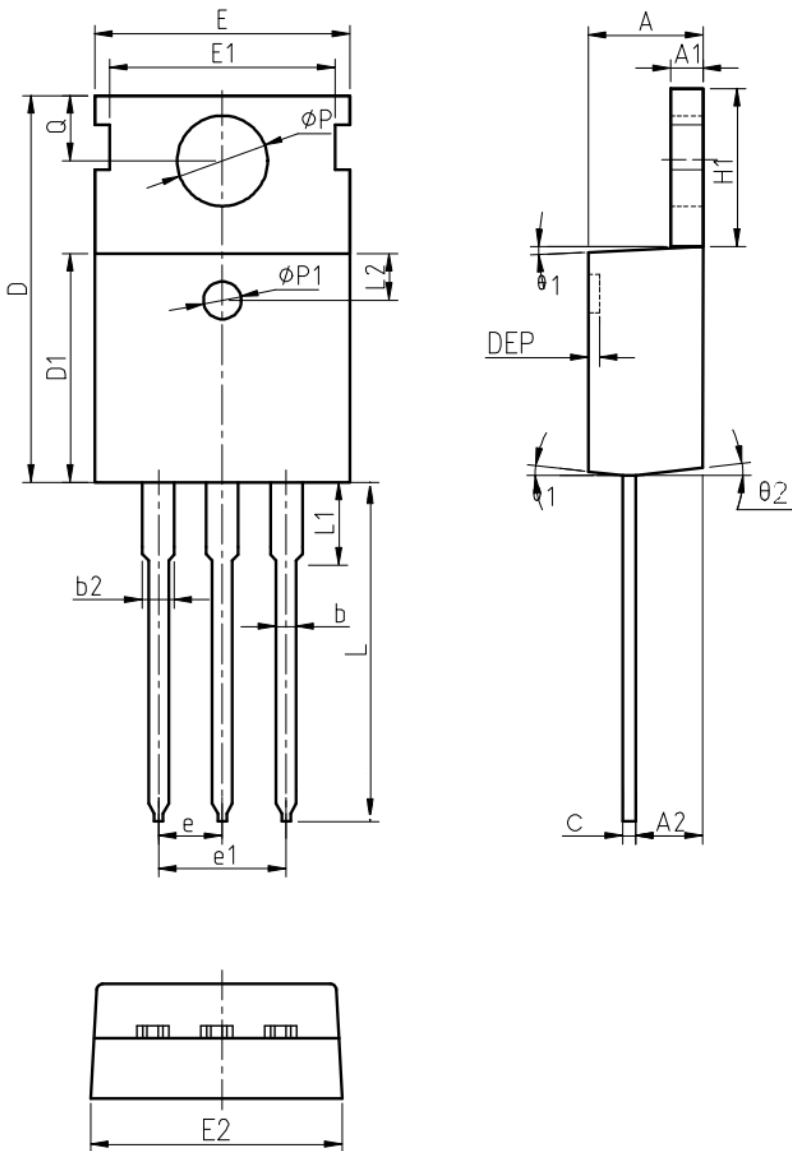

Symbol	Dimensions (unit: mm)		
	Min	Typ	Max
<b>A</b>	4.30	4.52	4.70
<b>A1</b>	1.15	1.30	1.40
<b>A2</b>	2.20	2.40	2.60
<b>b</b>	0.70	0.80	1.00
<b>b2</b>	1.17	1.32	1.50
<b>c</b>	0.45	0.50	0.61
<b>D</b>	15.30	15.65	15.90
<b>D1</b>	9.00	9.20	9.40
<b>DEP</b>	0.05	0.10	0.25
<b>E</b>	9.66	9.90	10.28
<b>E1</b>	-	8.70	-
<b>E2</b>	9.80	10.00	10.20
$\phi P1$	1.40	1.50	1.60
<b>e</b>	2.54 BSC		
<b>e1</b>	5.08 BSC		
<b>H1</b>	6.40	6.50	6.80
<b>L</b>	12.70	-	14.27
<b>L1</b>	-	-	3.95
<b>L2</b>	2.40	2.50	2.60
$\phi P$	3.53	3.60	3.70
<b>Q</b>	2.70	2.80	2.90
$\theta1$	5 °	7 °	9 °
$\theta2$	1 °	3 °	5 °

### Notes:

1. Refer to JEDEC TO-220 variation AB
2. Dimension "D" and "E" do NOT include mold flash. Mold flash shall not exceed 0.127mm per side.

## Customer Service

### Sales and Service:

[sales@vgsemi.com](mailto:sales@vgsemi.com)

Vanguard Semiconductor CO., LTD

TEL: (86-755) -26902410

FAX: (86-755) -26907027

WEB: [www.vgsemi.com](http://www.vgsemi.com)