

Pioneer

**AUDIO/VIDEO
MULTI-CHANNEL RECEIVER**

VSX-D209

Operating Instructions

Congratulations on buying this fine Pioneer product.

Please read through these operating instructions so you will know how to operate your model properly. After you have finished reading the instructions, put them away in a safe place for future reference.

WARNING: TO PREVENT FIRE OR SHOCK HAZARD, DO NOT EXPOSE THIS APPLIANCE TO RAIN OR MOISTURE.

IMPORTANT NOTICE

The serial number for this equipment is located on the rear panel. Please write this serial number on your enclosed warranty card and keep it in a secure area. This is for your security.

IMPORTANT



The lightning flash with arrowhead symbol, within an equilateral triangle, is intended to alert the user to the presence of uninsulated "dangerous voltage" within the product's enclosure that may be of sufficient magnitude to constitute a risk of electric shock to persons.

CAUTION

**RISK OF ELECTRIC SHOCK
DO NOT OPEN**

CAUTION:
TO PREVENT THE RISK OF ELECTRIC SHOCK, DO NOT REMOVE COVER (OR BACK). NO USER-SERVICEABLE PARTS INSIDE. REFER SERVICING TO QUALIFIED SERVICE PERSONNEL.



The exclamation point within an equilateral triangle is intended to alert the user to the presence of important operating and maintenance (servicing) instructions in the literature accompanying the appliance.

This equipment has been tested and found to comply with the limits for a Class B digital device, pursuant to Part 15 of the FCC Rules. These limits are designed to provide reasonable protection against harmful interference in a residential installation. This equipment generates, uses, and can radiate radio frequency energy and, if not installed and used in accordance with the instructions, may cause harmful interference to radio communications. However, there is no guarantee that interference will not occur in a particular installation. If this equipment does cause harmful interference to radio or television reception, which can be determined by turning the equipment off and on, the user is encouraged to try to correct the interference by one or more of the following measures:

- Reorient or relocate the receiving antenna.
- Increase the separation between the equipment and receiver.
- Connect the equipment into an outlet on a circuit different from that to which the receiver is connected.
- Consult the dealer or an experienced radio/TV technician for help.

POWER-CORD CAUTION

Handle the power cord by the plug. Do not pull out the plug by tugging the cord and never touch the power cord when your hands are wet as this could cause a short circuit or electric shock. Do not place the unit, a piece of furniture, etc., on the power cord, or pinch the cord. Never make a knot in the cord or tie it with other cords. The power cords should be routed such that they are not likely to be stepped on. A damaged power cord can cause a fire or give you an electrical shock. Check the power cord once in a while. When you find it damaged, ask your nearest PIONEER authorized service center or your dealer for a replacement.

MAINTENANCE OF EXTERNAL SURFACES

- Use a polishing cloth or dry cloth to wipe off dust and dirt.
- When the surfaces are very dirty, wipe with a soft cloth dipped in some neutral cleanser diluted five or six times with water, and wrung out well, and then wipe again with a dry cloth. Do not use furniture wax or cleaners.
- Never use thinners, benzene, insecticide sprays or other chemicals on or near this unit, since these will corrode surfaces.

Information to User

Alteration or modifications carried out without appropriate authorization may invalidate the user's right to operate the equipment.

IMPORTANT SAFETY INSTRUCTIONS

READ INSTRUCTIONS — All the safety and operating instructions should be read before the product is operated.

RETAIN INSTRUCTIONS — The safety and operating instructions should be retained for future reference.

HEED WARNINGS — All warnings on the product and in the operating instructions should be adhered to.

FOLLOW INSTRUCTIONS — All operating and use instructions should be followed.

CLEANING — Unplug this product from the wall outlet before cleaning. The product should be cleaned only with a polishing cloth or a soft dry cloth. Never clean with furniture wax, benzine, insecticides or other volatile liquids since they may corrode the cabinet.

ATTACHMENTS — Do not use attachments not recommended by the product manufacturer as they may cause hazards.

WATER AND MOISTURE — Do not use this product near water — for example, near a bathtub, wash bowl, kitchen sink, or laundry tub; in a wet basement; or near a swimming pool; and the like.

ACCESSORIES — Do not place this product on an unstable cart, stand, tripod, bracket, or table. The product may fall, causing serious injury to a child or adult, and serious damage to the product. Use only with a cart, stand, tripod, bracket, or table recommended by the manufacturer, or sold with the product. Any mounting of the product should follow the manufacturer's instructions, and should use a mounting accessory recommended by the manufacturer.

CART — A product and cart combination should be moved with care. Quick stops, excessive force, and uneven surfaces may cause the product and cart combination to overturn.



VENTILATION — Slots and openings in the cabinet are provided for ventilation and to ensure reliable operation of the product and to protect it from overheating, and these openings must not be blocked or covered. The openings should never be blocked by placing the product on a bed, sofa, rug, or other similar surface. This product should not be placed in a built-in installation such as a bookcase or rack unless proper ventilation is provided or the manufacturer's instructions have been adhered to.

POWER SOURCES — This product should be operated only from the type of power source indicated on the marking label. If you are not sure of the type of power supply to your home, consult your product dealer or local power company.

LOCATION — The appliance should be installed in a stable location.

NONUSE PERIODS — The power cord of the appliance should be unplugged from the outlet when left unused for a long period of time.

GROUNDING OR POLARIZATION

- If this product is equipped with a polarized alternating current line plug (a plug having one blade wider than the other), it will fit into the outlet only one way. This is a safety feature. If you are unable to insert the plug fully into the outlet, try reversing the plug. If the plug should still fail to fit, contact your electrician to replace your obsolete outlet. Do not defeat the safety purpose of the polarized plug.
- If this product is equipped with a three-wire grounding type plug, a plug having a third (grounding) pin, it will only fit into a grounding type power outlet. This is a safety feature. If you are unable to insert the plug into the outlet, contact your electrician to replace your obsolete outlet. Do not defeat the safety purpose of the grounding type plug.

POWER-CORD PROTECTION — Power-supply cords should be routed so that they are not likely to be walked on or pinched by items placed upon or against them, paying particular attention to cords at plugs, convenience receptacles, and the point where they exit from the product.

OUTDOOR ANTENNA GROUNDING — If an outside antenna or cable system is connected to the product, be sure the antenna or cable system is grounded so as to provide some protection against voltage surges and built-up static charges. Article 810 of the National Electrical Code, ANSI/NFPA 70, provides information with regard to proper grounding of the mast and supporting structure, grounding of the lead-in wire to an antenna discharge unit, size of grounding conductors, location of antenna-discharge unit, connection to grounding electrodes, and requirements for the grounding electrode. See Figure A.

LIGHTNING — For added protection for this product during a lightning storm, or when it is left unattended and unused for long periods of time, unplug it from the wall outlet and disconnect the antenna or cable system. This will prevent damage to the product due to lightning and power-line surges.

POWER LINES — An outside antenna system should not be located in the vicinity of overhead power lines or other electric light or power circuits, or where it can fall into such power lines or circuits. When installing an outside antenna system, extreme care should be taken to keep from touching such power lines or circuits as contact with them might be fatal.

OVERLOADING — Do not overload wall outlets, extension cords, or integral convenience receptacles as this can result in a risk of fire or electric shock.

OBJECT AND LIQUID ENTRY — Never push objects of any kind into this product through openings as they may touch dangerous voltage points or short-out parts that could result in a fire or electric shock. Never spill liquid of any kind on the product.

SERVICING — Do not attempt to service this product yourself as opening or removing covers may expose you to dangerous voltage or other hazards. Refer all servicing to qualified service personnel.

DAMAGE REQUIRING SERVICE — Unplug this product from the wall outlet and refer servicing to qualified service personnel under the following conditions:

- When the power-supply cord or plug is damaged.
- If liquid has been spilled, or objects have fallen into the product.
- If the product has been exposed to rain or water.
- If the product does not operate normally by following the operating instructions. Adjust only those controls that are covered by the operating instructions as an improper adjustment of other controls may result in damage and will often require extensive work by a qualified technician to restore the product to its normal operation.
- If the product has been dropped or damaged in any way.
- When the product exhibits a distinct change in performance — this indicates a need for service.

REPLACEMENT PARTS — When replacement parts are required, be sure the service technician has used replacement parts specified by the manufacturer or have the same characteristics as the original part. Unauthorized substitutions may result in fire, electric shock, or other hazards.

SAFETY CHECK — Upon completion of any service or repairs to this product, ask the service technician to perform safety checks to determine that the product is in proper operating condition.

WALL OR CEILING MOUNTING — The product should not be mounted to a wall or ceiling.

HEAT — The product should be situated away from heat sources such as radiators, heat registers, stoves, or other products (including amplifiers) that produce heat.

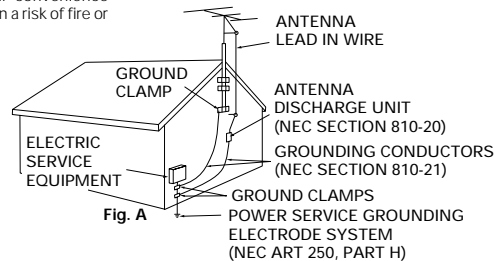

NEC — NATIONAL ELECTRICAL CODE

Features

Five channels of independent amplification

Five independent power amplifiers, each rated at 60W, ensure accurate, dynamic reproduction of all multi-channel material.

Dolby* Pro Logic

Enjoy stunning multi-channel, surround sound effects from movies and other material recorded in Dolby Surround/Pro Logic. Enhance your listening experience further with built-in signal processing that recreates the movie theater ambience in your living room.

Digital surround effects

Using Digital Signal Processing (DSP) technology, various listening environments, such as a theater or a jazz club, may be simulated and applied to any music or video source.

DVD 5.1 channel input

A special 5.1 Channel input makes the VSX-D209 fully compatible with Dolby Digital decoders and DVD players with 5.1 channel outputs.

The Energy-saving Design

This unit is designed to use minimal electricity when power is switched OFF (in Standby mode). Regarding the value of the power consumption in standby mode, refer to "Specifications" on pages 31.

** Manufactured under license from Dolby Laboratories. "Dolby", "Pro Logic" and the double-D symbol are trademarks of Dolby Laboratories. Confidential unpublished works. © 1992-1997 Dolby Laboratories. All rights reserved.*

Introductory Information	6
Checking the Supplied Accessories	6
Using this Manual	6
Installing the Receiver	6
Preparing the Remote Control	7
<hr/>	
Connecting Your System	8
Connecting Antennas	8
Connecting Audio Components	9
Connecting DVD 5.1 Channel Components	10
Connecting Video Components	10
Connecting Speakers	11
AC OUTLET	12
<hr/>	
Setting Up for Surround Sound	13
Setting Up for Surround Sound	13
<hr/>	
Displays & Controls	17
Front Panel	17
Display	18
Remote Control	19
<hr/>	
Listening in Surround Sound	20
Listening in Dolby Pro Logic Mode	20
Listening in DVD 5.1 Channel Input Mode	21
Listening in DSP Mode	22
<hr/>	
Using the Tuner	23
Finding a Station	23
Tuning Directly to a Station	24
Memorizing Stations	24
Recalling Memorized Stations	25
<hr/>	
Making a Recording	26
Making an Audio or Video Recording	26
<hr/>	
Controlling the Rest of Your System	27
CD/MD/CD-R Player Controls	27
TV Controls	27
Cassette Deck Controls	28
DVD Player Controls	29
<hr/>	
Additional Information	30
Troubleshooting	30
Specifications	31

Checking the Supplied Accessories

Please check that you've received the following supplied accessories:

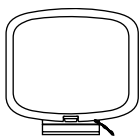

AM loop antenna



FM wire antenna

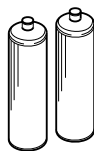

AA size IEC R6P
batteries (x2)

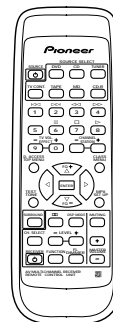

Remote control unit

Using this Manual

This manual is for the VSX-D209 audio/video multi-channel receiver. It is divided into two main sections:

Set up

This section covers installing your receiver and connecting up all the other components in your home theater system to it. It also describes how to set up a multi-channel speaker system to take full advantage of the great surround sound features of your receiver.

Operation

This section shows you how to use every feature of the receiver and its remote control unit. It also covers using the supplied remote control to operate your other home theater components. To find out more about a specific button, control or indicator, see Displays & Controls starting on page 17. This will point you to the relevant chapter in the manual. In the Additional Information section (p.30-31) you'll find a troubleshooting section and specifications.

The following symbols are used throughout this manual:



Provides detailed precautions and advice on operations, etc.



Indicates that display is blinking.

Installing the Receiver

Please note:

- Do not place objects directly on top of this unit. This would prevent proper heat dispersal.
- When installing in a rack, shelf, etc., be sure to leave more than 8 inches of space above the receiver.

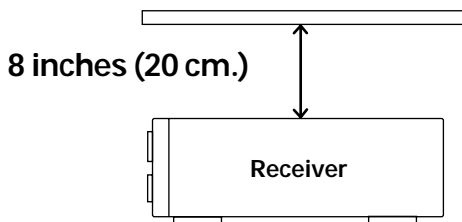

Preparing the Remote Control

Loading the batteries

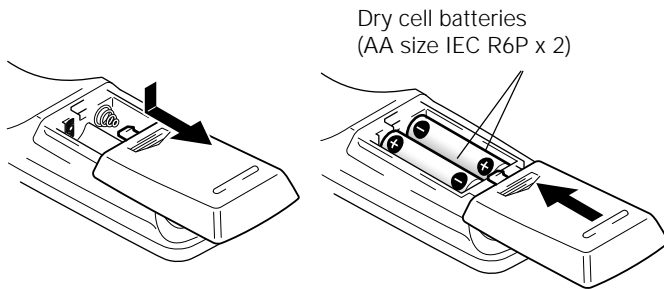

CAUTION!

Incorrect use of batteries may result in such hazards as leakage and bursting. Observe the following precautions:

- Never use new and old batteries together.
- Insert the plus and minus sides of the batteries properly according to the marks in the battery case.
- Batteries with the same shape may have different voltages. Do not use different batteries together.

Operating range of remote control unit



The remote control may not work properly if:

- There are obstacles between the remote control and the receiver's remote sensor.
- Direct sunlight or fluorescent light is shining onto the remote sensor.
- The receiver is located near a device that is emitting infrared rays.
- The receiver is operated simultaneously with another infrared remote control unit.

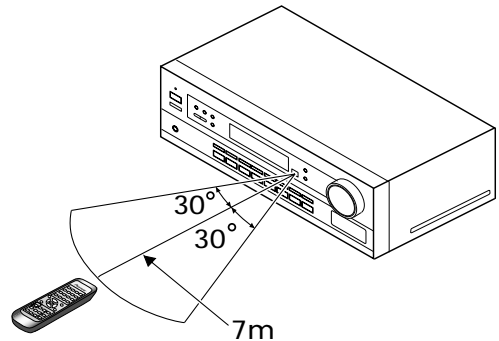

The FUNCTION & SOURCE SELECT buttons on the remote control

Please note that the remote control has two types of buttons, one called FUNCTION and a set of buttons called SOURCE SELECT. Use the FUNCTION button to choose the component you want to listen to (CD, CDR/TAPE, TUNER, etc.) and use the SOURCE SELECT buttons to change which component the remote control itself will operate. Thus, if the VSX-D209 is in TUNER mode, for example, and you want to listen to your CD player, you need to select the CD mode with the FUNCTION button.

Operating other Pioneer components

By connecting a control cord (optional), you can control other Pioneer equipment using this remote control unit. Point the remote control unit towards the remote sensor of this unit, even when operating other equipment.

The remote control signals are received by the remote sensor of this unit, and sent to the other devices via the **CONTROL OUT** terminal.

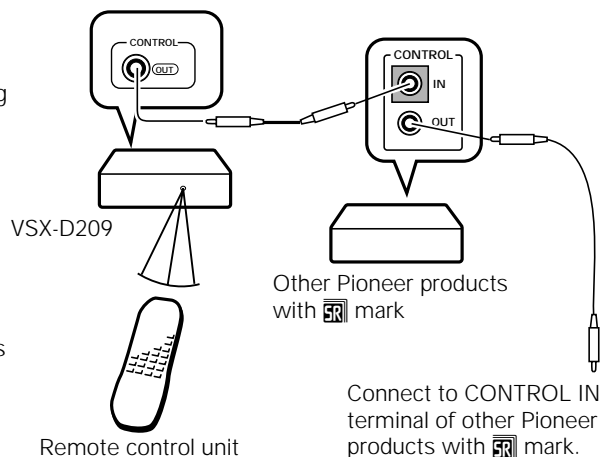

You can also control Pioneer components by pointing the receiver's remote control directly at the component. This type of operation does not require control cords.

Connecting Your System

Connecting Antennas

Connect the AM loop antenna and the FM wire antenna as shown below. To improve reception and sound quality, connect external antennas (see Using external antennas, below). Always make sure that the receiver is switched off and unplugged from the wall outlet before making or changing any connections.

AM loop antenna

Assemble the antenna and connect to the receiver. Attach to a wall, etc. (if desired) and face in the direction that gives the best reception.

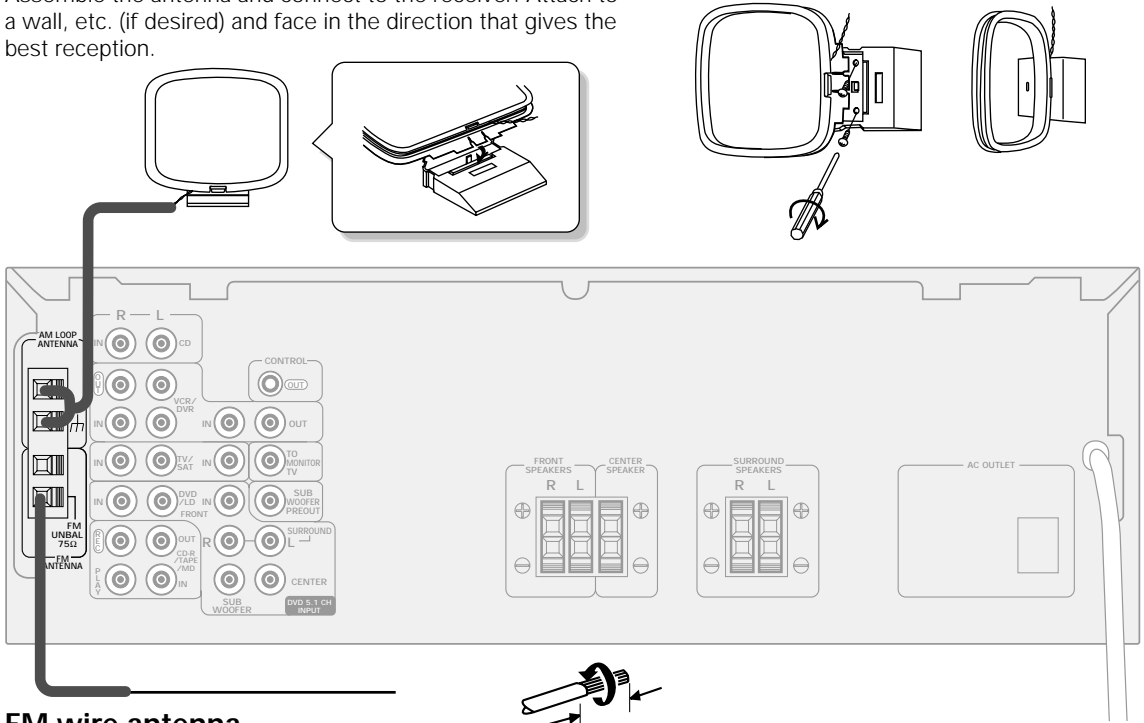

FM wire antenna

Connect the FM wire antenna and fully extend vertically along a window frame or other suitable area, etc.

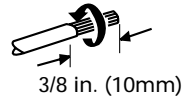

3/8 in. (10mm)

Antenna snap connectors

Twist the exposed wire strands together and insert into the hole, then snap the connector shut.

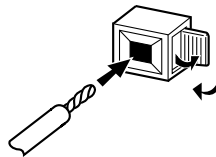

Using external antennas

■ To improve FM reception

Connect an external FM antenna.

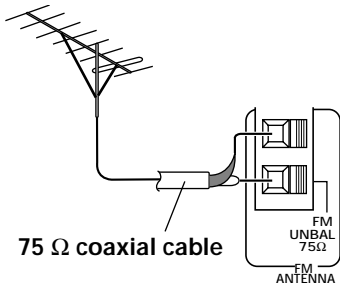

■ To improve AM reception

Connect a 15-18 feet length of vinyl-coated wire to the AM antenna terminal without disconnecting the supplied AM loop antenna. For the best possible reception, suspend horizontally outdoors.

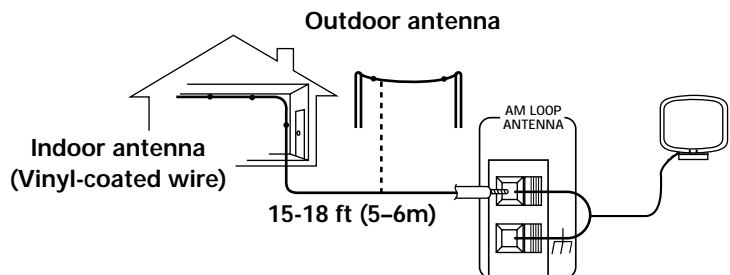

Connecting Audio Components

Connect your audio components as shown below. When connecting equipment, always make sure the power switched off and the power cord is disconnected from the wall outlet.

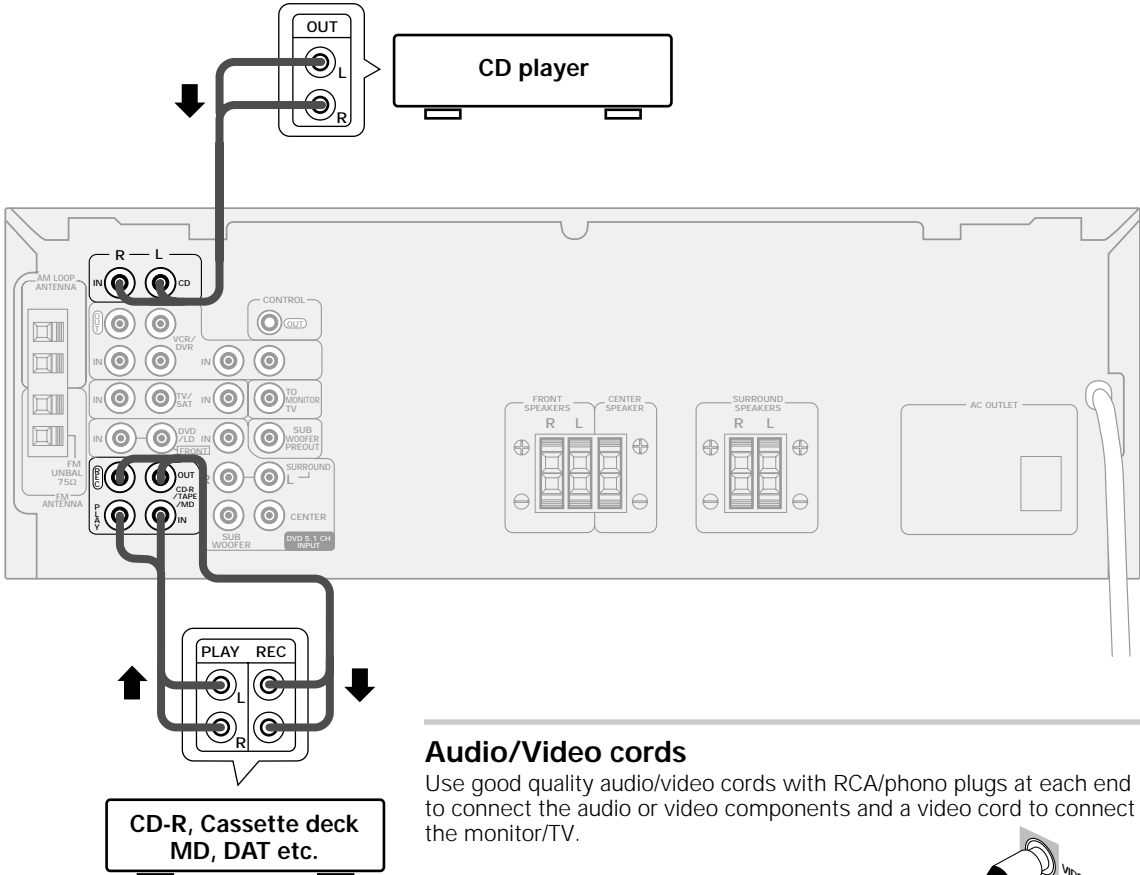

Audio/Video cords

Use good quality audio/video cords with RCA/phono plugs at each end to connect the audio or video components and a video cord to connect the monitor/TV.

Connect red plugs to R (right), white plugs to L (left), and the yellow plugs to VIDEO.

Be sure to push home the plugs into their sockets.

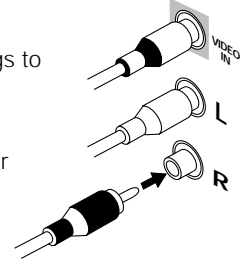

Cassette deck placement

Depending on where the cassette deck is placed, noise caused by leakage flux from the transformer in the receiver may occur during playback. If you experience noise, move the cassette deck farther away from the receiver.

Connecting DVD 5.1 Channel Components

DVD and LD discs are compatible with both 2 channel and 5.1 channel audio output formats. Refer to page 21 for more information on how to switch between the two input methods. Connections can be made from a DVD player, multi channel decoder equipped with 5.1 analog outputs to the 5.1 analog inputs on this unit. Always make sure that the receiver is switched off and unplugged from the wall outlet before making or changing any connections.

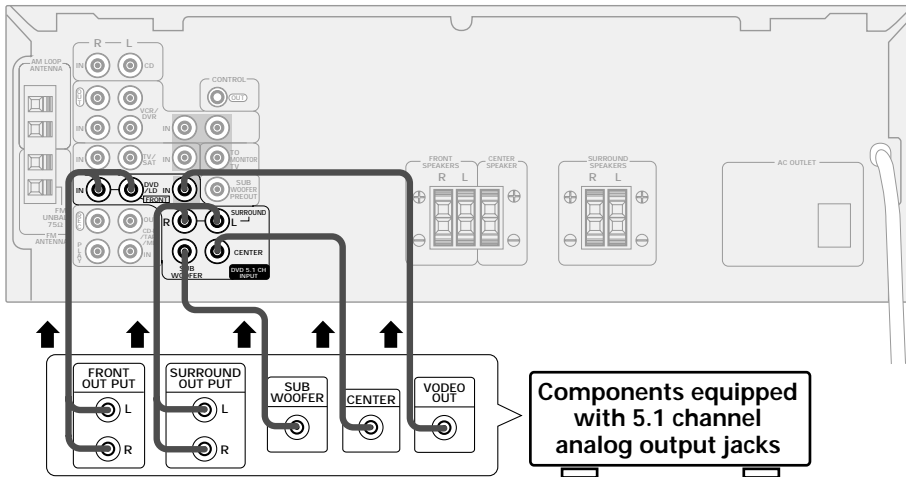

The 5.1 channel input can only be used when DVD 5.1 CH is selected.

Connecting Video Components

Connect your video components as shown below. When connecting equipment, make sure the power is switched off and the power cord disconnected from the wall outlet.

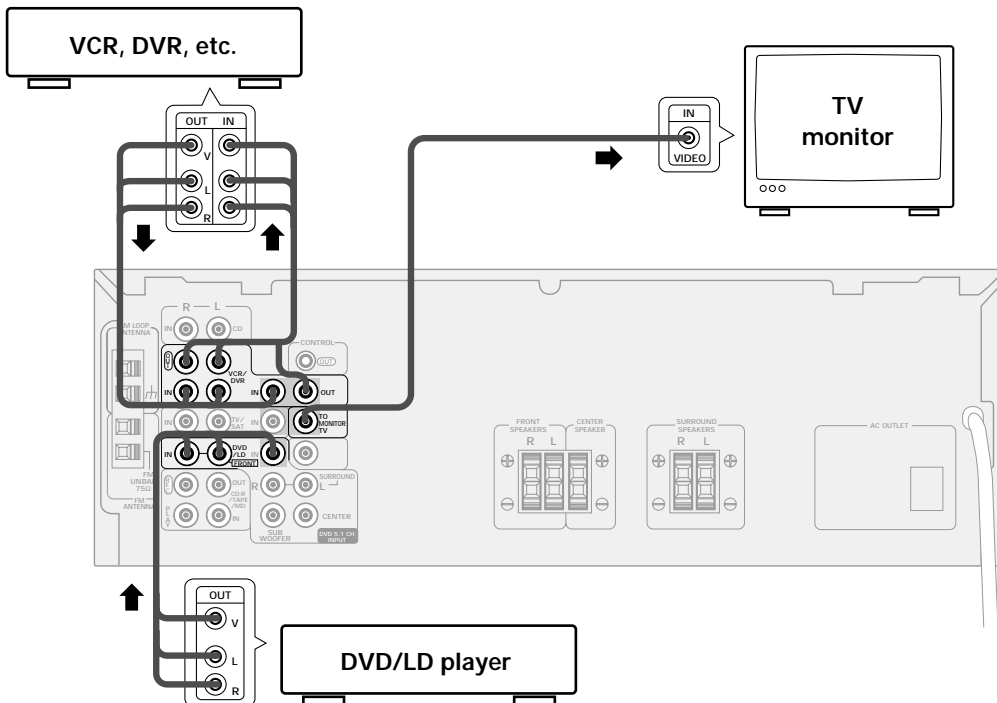

Connecting Speakers

Connect your speakers as shown below. Be sure to connect each speaker to the appropriate speaker terminals, and also to connect the positive and negative terminals correctly (positive to positive, negative to negative). When connecting equipment, always make sure the power switched off and the power cord is disconnected from the wall outlet.

- Use speakers with a nominal impedance of 8 Ω to 16 Ω.

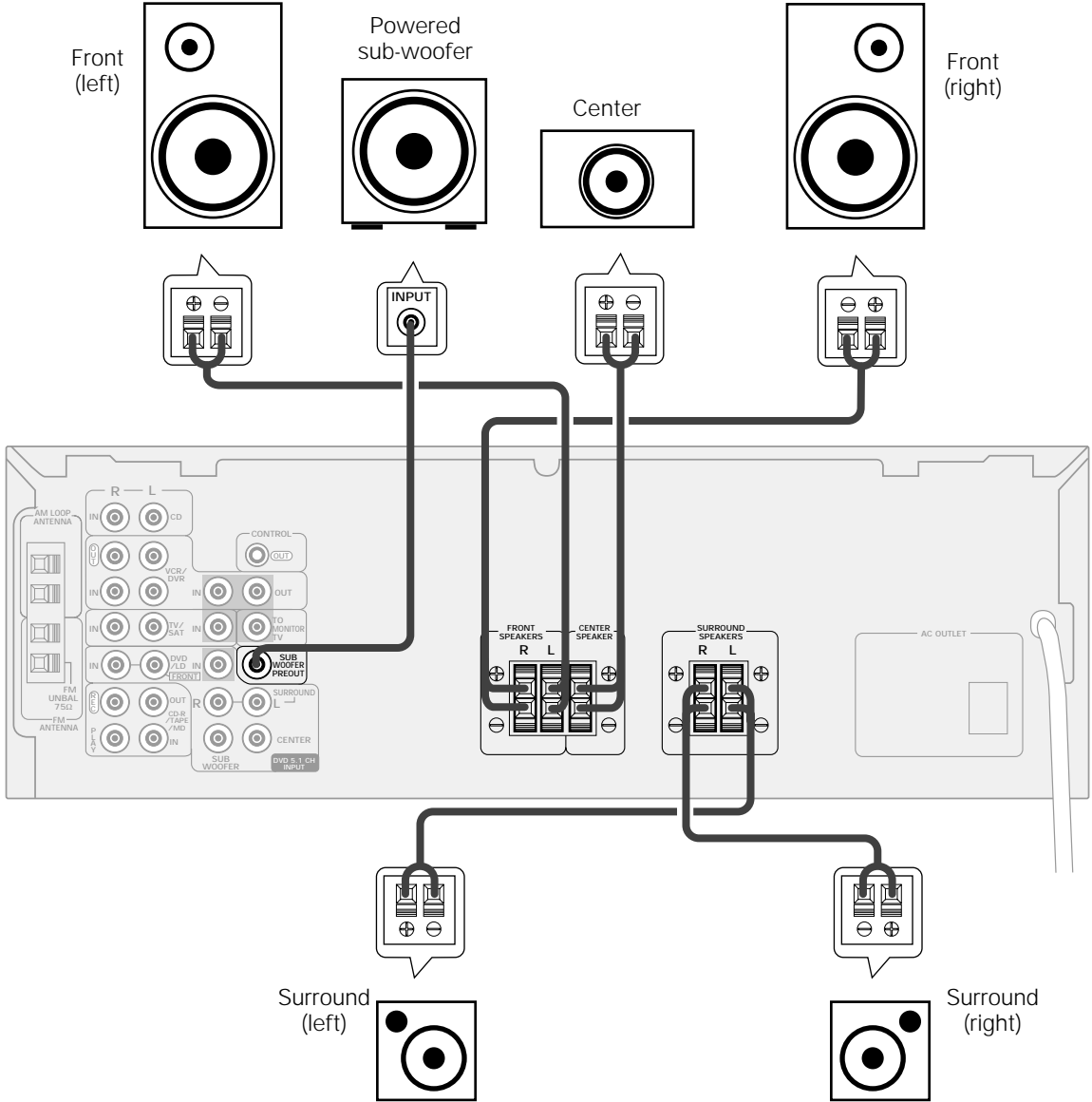

Speaker terminals

Use good quality speaker wire to connect the speakers to the receiver.

- ① Twist around 1/2 inch of bare wire strands together.
- ② Unclip the speaker terminal and insert the wire.
- ③ Snap shut the speaker terminal to secure.

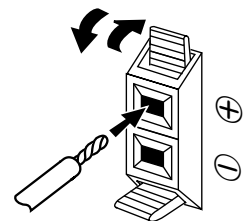

Hints on speaker placement

Speakers are usually designed with a particular placement in mind. Some are designed to be floorstanding, while others should be placed on stands to sound their best. Some should be placed near a wall; others should be placed away from walls. Follow the guidelines on placement that the speaker manufacturer provided with your particular speakers to get the most out of them.

- Place the front left and right speakers at equal distances from the TV.
- When placing speakers near the TV, we recommend using magnetically shielded speakers to prevent possible interference, such as discoloration of the picture when the TV is switched on. If you do not have magnetically shielded speakers and notice discoloration of the TV picture, move the speakers farther away from the TV.
- Install the center speaker above or below the TV so that the sound of the center channel is localized at the TV screen.

CAUTION!

If you choose to install the center speaker on top of the TV, be sure to secure it with putty, or by other suitable means, to reduce the risk of damage or injury resulting from the speaker falling from the TV in the event of external shocks such as earthquakes.

- If possible, install the surround speakers slightly above ear level.
- Try not to install the surround speakers farther away from the listening position than the front and center speakers. Doing so can weaken the surround sound effect.

To achieve the best possible surround sound, install your speakers as shown below. Be sure all speakers are installed securely to prevent accidents and improve sound quality.

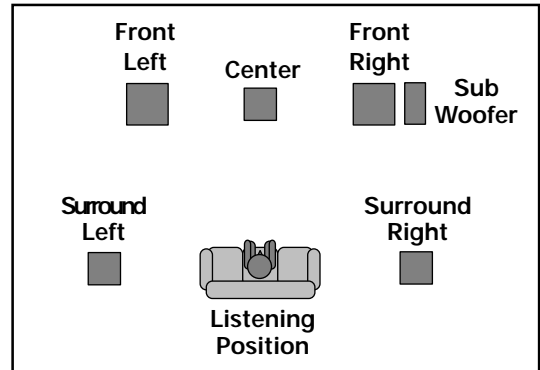

3-D View of speaker set up

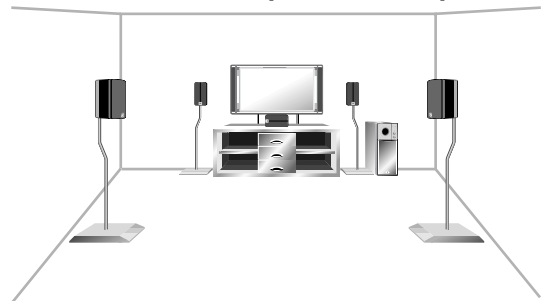

AC OUTLET [SWITCHED 100 W (0.8 A) MAX]

Power supplied through this outlet is turned on and off by the receiver's STANDBY/ON button.

Total electrical power consumption of connected equipment should not exceed 100 W (0.8 A).

Do not connect a heater, TV, etc.



- This unit should be disconnected by removing the power plug from the wall socket when not in regular use, e.g., on vacation.
- Do not connect appliances with high power consumption such as heaters, irons, or television sets to this AC OUTLET in order to avoid overheating and fire risk. This can also cause the receiver to malfunction.

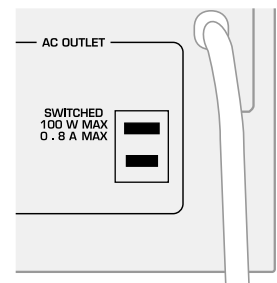

CAUTION:
DO NOT CONNECT A MONITOR OR TV SET TO THIS UNIT'S AC OUTLET.

Setting Up for Surround Sound

Setting Up for Surround Sound

The VSX-D209 offers several options for surround sound listening, depending on the speakers in your set up. Having installed the speakers in your room it's important to set up the relative volume levels and delay time in order to make the most of the receiver's surround sound capabilities. You only need to make these settings once, unless you change the placement of your current speaker system or add new speakers, etc.

Setting the center mode, the subwoofer and speaker distances

It is important to set the type of center mode which corresponds to your speaker system, set the subwoofer on/off and set speaker distances as well as set volume levels of each speaker. From your normal listening position, the volumes of the various speakers in your system should appear to be equal. Follow the steps below to do all of these things, especially adjust the volumes of the center and surround speakers relative to the main front speakers for Dolby Pro Logic mode, 5.1 CH. mode and the DSP mode.

1 Switch on the receiver.

2 Press the SURROUND button.

3 Press the ► button to select the surround sound setup mode.

Repeatedly pressing the button cycles through the three setup modes (center mode setup; subwoofer setup; distance setup). The mode appears in the display on the front panel.

4 Use the ▲▼ buttons to select one of the four types of center mode.

See the center mode cycle shown here and the diagrams below explaining each center mode to decide which center mode to choose

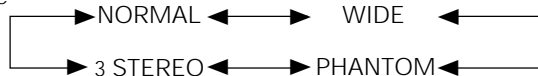

Normal

Middle and high frequency sounds are heard from the center speaker.
Bass frequencies from the center channel are played through the front speakers.

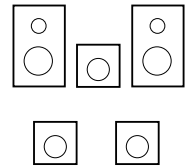

Wide

If a full range speaker is used for the center channel, all center channel sound, including bass frequencies, are heard through the center speaker.

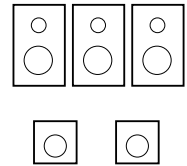

Phantom

Center channel sounds are played through both front speakers equally.

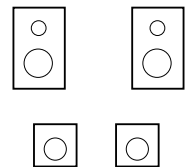

3 Stereo

Surround channel sounds and center channel bass frequencies are heard through the front stereo speakers.

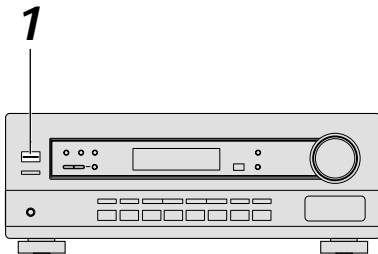
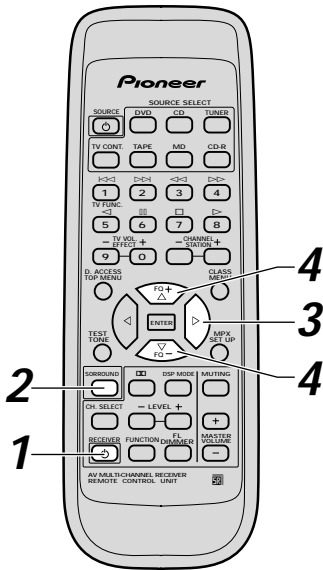
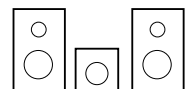

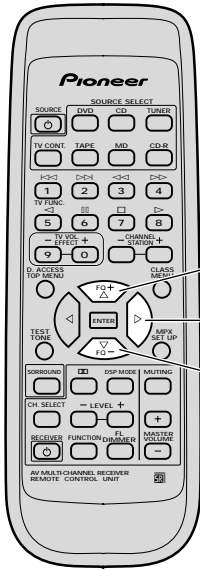

5 Press the ► button to select the SUBWF (subwoofer) select mode.

6 Use the ▲▼ buttons to turn the subwoofer function on or off.

Select SUBWF ON if you have a subwoofer and SUBWF OFF if you don't have a subwoofer.

7 Press the ► button to select the distance mode for the FRNT (front) speakers.

For true surround sound effect the sound from the front speakers and the surround speakers should arrive to the listener's ears at a slightly different time. Telling the receiver how far your front and surround speakers are from your listening position will allow for this. The first distance setting you'll see will be FRNT for your front speakers. You can set the distance in a range from 1-30 feet.

8 Press the ▲▼ buttons to increase/decrease the distance of the FRNT speakers.

You need to judge(or measure) how far the speakers are from your normal listening position and set the distance accordingly. You can set the distance in a range from 1-30 feet.

9 Press the ► button to select the distance mode for the SURR (surround) speakers.

10 Press the ▲▼ buttons to increase/decrease the distance of the SURR speakers.

Again, You need to judge how far the speakers are from your normal listening position and set the distance accordingly. As above, you can set the distance in a range from 1-30 feet.

When you are finished setting up the delay time the receiver will return to normal operating mode after about 20 seconds. Alternatively, you can cycle through the options with the ◀▶ buttons until you return to the regular operating mode.



You only need to make the distance settings if your system has surround speakers.

Setting up speaker levels for Dolby Pro Logic

In order to get the best surround sound you need to set up the relative speaker levels so that they all have the same volume from your normal listening position. Follow the steps below using the TEST TONE to do this.

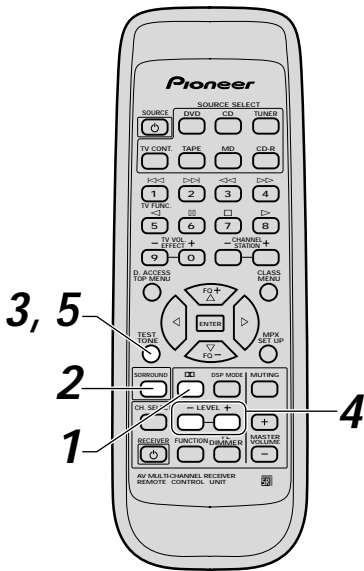

1 Press the  button.

2 Press the SURROUND button.

3 Press the TEST TONE button.

A short test tone will be heard in turn from each speaker in your set up. No test tone is heard from the sub woofer, however.

4 Adjust the respective speaker levels with the LEVEL +/- buttons when the TEST TONE sounds from that speaker.

Adjust the volumes of the speakers so that the volume of all speakers appears equal from your normal listening position.

5 Press TEST TONE again.

When you are satisfied that the set up is complete, press the TEST TONE button to return to normal operation.



- No TEST TONE sounds for the subwoofer
- These speaker level settings are applicable to PRO LOGIC, PRO LOGIC THEATER 1 & PRO LOGIC THEATER 2 settings.

Setting up speaker levels for DVD CH 5.1

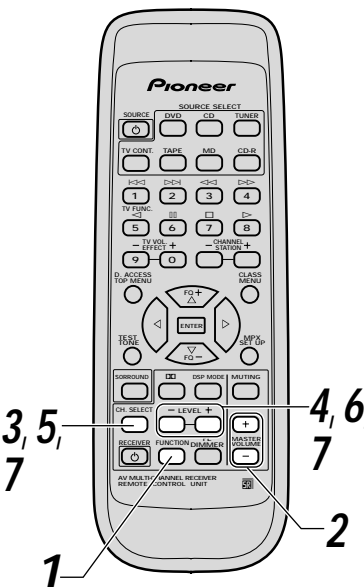

1 Use the FUNCTION button to select DVD 5.1 CH input mode.

2 Play a DVD 5.1 CH source and set master volume to a moderate level.

3 Press the CH. SELECT button.

The first speaker, FL (front left), and its relative volume level (+/- **dB) appears in the display.

4 Adjust the front left (FL) speaker level with the LEVEL +/- buttons.

Adjust the volumes of the speakers to a standard level of your choice when seated in your normal listening position.

5 Press CH. SELECT again to move to the next speaker.

The second speaker CT (center) and its relative volume level (+/- **dB) appears in the display.

6 Adjust the center (CT) speaker level with the LEVEL +/- buttons.

Adjust the speaker volume so it seems the same as the previous speaker from your normal listening position.

7 Repeat steps 3 & 4 for all of your speakers.

Adjust the volumes of the all speakers so their volume seems the same from your normal listening position.

Setting up speaker levels for DSP

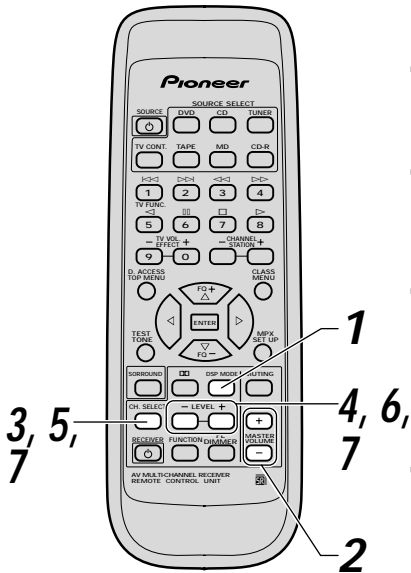

1 Use the DSP MODE button to turn on a DSP effect. You can cycle through the five different types with the DSP button.

2 Play a source (CD, tape, etc.) and set master volume to a moderate level.

3 Press the CH. SELECT button.

The first speaker FL (front left) and its relative volume level (+/- **dB) appears in the display.

4 Adjust the front left (FL) speaker level with the LEVEL +/- buttons.

Adjust the volumes of the speakers to a standard level of your choice when seated in your normal listening position.

5 Press CH. SELECT again to move to the next speaker.

The second speaker CT (center) and its relative volume level (+/- **dB) appears in the display.

6 Adjust the center (CT) speaker level with the LEVEL +/- buttons.

Adjust the volume of the speaker so its volume seems the same as the previous speaker from your normal listening position.

7 Repeat steps 3 & 4 for all of your speakers.

Adjust the volumes of the all speakers so their volume seems the same from your normal listening position.



- These speaker level settings are applicable to DSP effects only.
- Each effect level applies only to the DSP type (HALL for example) that it is set in. You can set the effect levels for each type independently.

Front Panel

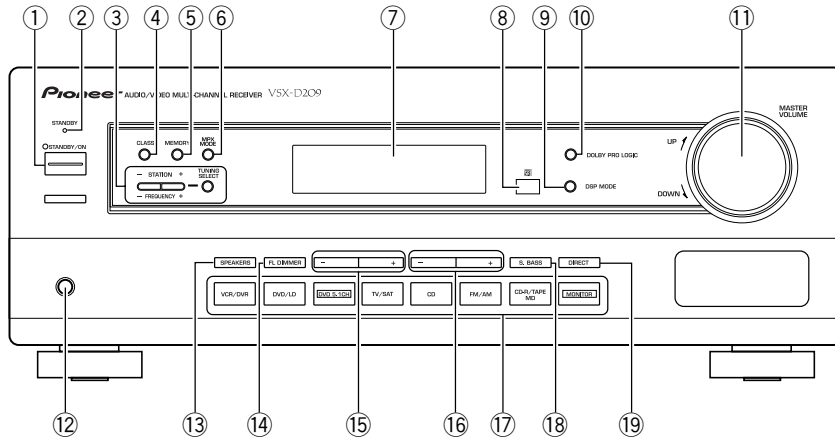

- ① **STANDBY/ON button**
Switches the receiver between on and standby.
- ② **STANDBY indicator**
Lights when the receiver is in standby mode (note that the receiver consumes a small amount of power (1W) in standby mode).
- ③ **STATION (+/-), FREQUENCY (+/-), TUNING SELECT buttons (see pages 23–25)**
STATION (+/-)
Selects station memories when using the tuner.
FREQUENCY (+/-)
Selects the frequency when using the tuner.
TUNING SELECT
Switches between station memory and frequency select modes.
- ④ **CLASS button (see page 25)**
Switches between the three banks (classes) of station memories.
- ⑤ **MEMORY button (see page 24)**
Press to memorize a station for recall using the STATION (+/-) buttons.
- ⑥ **MPX MODE button (see page 23)**
If the **TUNED** or **STEREO** indicators don't light when tuning to an FM station because the signal is weak, press the MPX button to switch the receiver into mono reception mode. This should improve the sound quality and allow you to enjoy the broadcast.
- ⑦ **Display (see page 18)**
- ⑧ **Remote sensor**
Receives the signals from the remote control.
- ⑨ **DSP MODE button (see page 22)**
Use to switch between the various DSP modes available (**HALL**, **JAZZ**, **DANCE**, **THEATER1**, **THEATER2**) and DSP off. Use to create different surround sound effects from any stereo source.
- ⑩ **DOLBY PRO LOGIC button (see page 20)**
Use to switch between the various Pro Logic modes (PRO LOGIC, PRO LOGIC THEATER1, PRO LOGIC THEATER2) and Pro Logic off.
- ⑪ **MASTER VOLUME**
Use to set the overall listening volume.
- ⑫ **PHONES jack**
Use to connect headphones but this does not switch the speakers off.
- ⑬ **SPEAKER button**
Use to switch the speaker system on or off.
- ⑭ **FL DIMMER button**
Use this button to make the fluorescent display (FL) dimmer or brighter. There are three brightness settings as well as an off setting.
- ⑮ **BASS (+/-) buttons**
Use to increase/decrease bass (within a range of -6dB to 6dB in 2dB steps). It cannot be used when S.BASS is on.
- ⑯ **TREBLE (+/-) buttons**
Use to increase/decrease treble (within a range of -6dB to 6dB in 2dB steps).
- ⑰ **Function buttons**
Use to select a source for playback or recording.
- ⑱ **S.BASS button**
Use to switch on and off the bass boost. Use for a more powerful bass sound. Negates use of BASS buttons.
- ⑲ **DIRECT button**
Use to switch DIRECT playback on or off. This mode bypasses the tone controls and channel levels for the most accurate reproduction of a program source.

Display

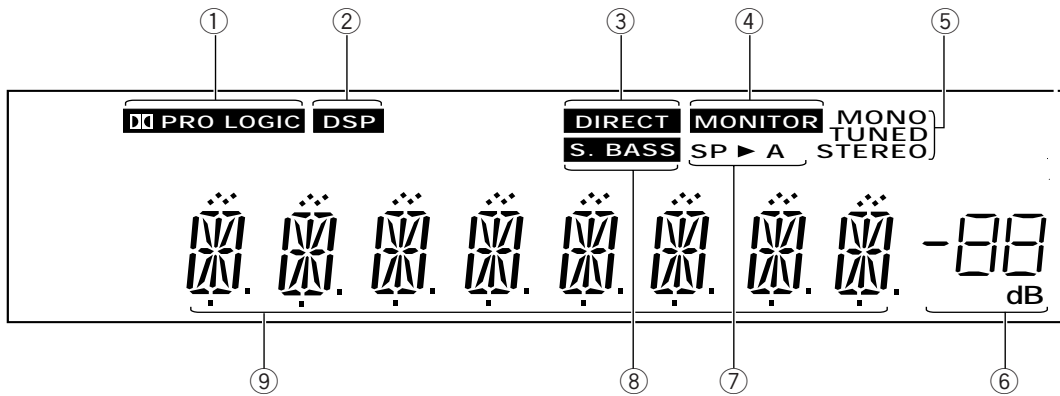

① **PRO LOGIC indicator**

Lights when any Dolby Pro Logic mode is selected.
The main character display briefly shows the current Pro Logic mode (**PRO LOGIC**, **THEATER1**, **THEATER2**) after selection (see page 20).

② **DSP indicator**

Lights when any DSP mode is selected. The main character display briefly shows the current DSP mode (**HALL**, **JAZZ**, **DANCE**, **THEATER1** and **THEATER2**) after selection (see page 22).

③ **DIRECT indicator**

Lights when source DIRECT is on. This function bypasses all tone, balance, DSP and Dolby Surround effects.

④ **MONITOR indicator**

Lights when **MONITOR** is selected to hear a recording as it's being made (see page. 26).

⑤ **TUNER indicators**

MONO:

Lights when the mono mode is set using the MPX MODE button (see page. 23).

TUNED:

Lights when a broadcast is being received.

STEREO:

Lights when a stereo FM broadcast is being received in auto stereo mode.

⑥ **MASTER VOLUME LEVEL**

Shows the overall volume level. Volume level is maintained even when the power is off. ---dB indicates the minimum level, and 0dB indicates the maximum level.

- Depending on the level settings for individual channels, the MAX level can range between -10dB and 0dB.

⑦ **SPEAKER indicator**

Shows if the speaker system is on or not. If **SP▶A** appears speakers are switched on. If **SP▶** appears speakers are switched off.

⑧ **S. BASS indicator**

Lights when the S. BASS is on (see note ⑱ page.17).

⑨ **CHARACTER display**

Shows the radio frequency or function (DVD/LD, CD, etc.) receiver is using .

Remote Control

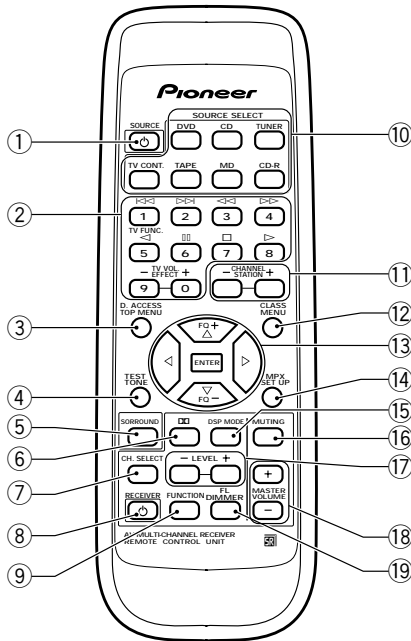

① SOURCE \odot (Power) button

This button turns on/off the power for PIONEER components connected to the VSX-D209.

② NUMBER/PLAYER COMMAND buttons (see page 24, 27-29)

Use to select the radio frequency in tuner mode. Also, you can use to control PIONEER components like CD players, cassette decks, etc. according to the commands printed above the button (4, 3, 7, etc.)

③ D.ACCESS/TOP MENU button (see page 24, 29)

This button gives you direct access to radio frequency input, allowing you to input a station directly. In DVD mode this button brings you to the top menu.

④ TEST TONE button (see page 15 & 23-24)

Use this button to hear a test tone from each speaker in turn to set the relative speaker volumes. Also switches the BAND in TUNER mode.

⑤ SURROUND button (see page 13, 15, 20, 22)

Use this button to set up the surround sound features of the VSX-D209. In particular, it's used to select the type of center mode, turn on/off subwoofer option and select delay time for each speaker. Also used to start the process of setting the effect levels

⑥ \square button (see page 15, 20)

Use to select a Dolby Pro Logic mode. Also used to access Test Tone.

⑦ CH. SELECT button (see page 15-16,)

Used to start the process of setting the speaker levels (see ⑰ below).

⑧ RECEIVER STANDBY/ON button

Use to switch the receiver between on and standby modes.

⑨ FUNCTION button

Use select the playback or recording source.

⑩ SOURCE SELECT keys

Use to put the remote control (NOT the receiver) in the stated mode.

For other equipment controls, see *Controlling the Rest of Your System* starting on page 27.

⑪ CHANNEL/STATION +/- buttons (see page.25, 27)

Use to select the station of memorized frequencies or change channels on Pioneer-made TVs.

⑫ CLASS/MENU button (see page. 25, 29)

Use to switch between the three banks (classes) of station memories.

⑬ \blacktriangleleft \blacktriangleright \blacktriangleup \blacktriangledown (FQ +/-) & ENTER buttons (see page.13, 14, 23)

Use these arrow buttons when setting up your surround sound system (see page. 13-16). These buttons are also used to control DVD menus/options and for deck 1 of a double cassette deck player. The FQ +/- buttons can be used to find radio frequencies.

⑭ MPX/SETUP MODE button (see page 23, 29)

Use to switch between auto stereo and mono reception of FM broadcasts. If the signal is weak then switching to MONO will improve the sound quality. In DVD mode this button brings up the SETUP menus.

⑮ DSP MODE button (see page 22)

Use to switch between the various DSP modes available (HALL, JAZZ, DANCE, THEATER1, THEATER2) and DSP off. Use to create different surround sound effects from any stereo source.

⑯ MUTING button

Use to mute all audio without affecting any of the current sound settings.

⑰ +/- LEVEL buttons (see page 15, 16)

Use to set the relative speaker volumes for all the speakers in your system (see ⑦ above).

⑱ MASTER VOLUME +/- buttons

Use to set the overall listening volume.

⑲ FL DIMMER button

Use this button to make the fluorescent display (FL) dimmer or brighter. There are three brightness settings as well as an off setting.

Listening in Dolby Pro Logic Mode

To really appreciate what the VSX-D209 can do, sit back and experience a movie encoded in Dolby Digital or Dolby Pro Logic with five speaker surround sound creating theater-like sound effects in your living room. When choosing software, look out for the **DOLBY SURROUND** mark on DVD discs, laser discs, and video tapes (sometimes, unmarked software is also recorded in Dolby Pro Logic).

To enjoy Dolby Digital surround sound from DVD discs, you'll need to have connected your DVD player (or Dolby Digital decoder) to the receiver's 5.1 channel inputs (see page 10), and set the receiver to DVD 5.1CH input mode. Turn to page 21 for more on this.

Many video tapes feature Dolby Surround/Pro Logic these days. The VSX-D209 takes advantage of this to provide dramatic and realistic surround sound. The effect can be further enhanced by choosing a Pro Logic with DSP mode. Follow the steps on this page when playing Dolby Surround or Dolby Pro Logic material.

When using any of these modes, it's really important that your speakers are set up correctly (see page. 11-12), and that you've worked through the steps in Setting Up for Surround Sound on pages 13-15.

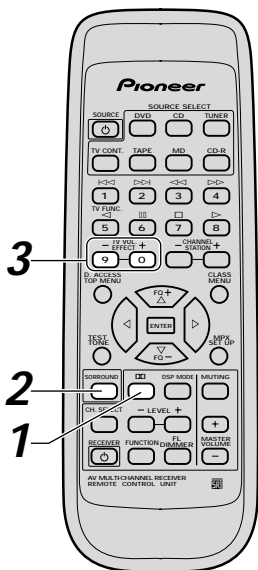

1 Press **DOLBY PRO LOGIC** on the receiver).

Pressing repeatedly changes the Pro Logic mode in the following sequence:

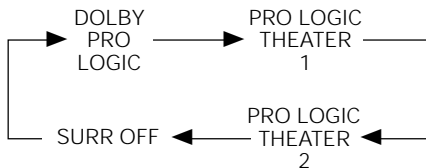

2 Press **SURROUND**.

This starts the process of setting the effect level.

3 Use the **EFFECT +/-** to adjust the DSP effect level **PRO LOGIC THEATER1** and **PRO LOGIC THEATER2**.

You can adjust the effect level within an range of 10-90 (the default setting is 50).



- You need to input mode/distance/level settings specifically for your Pro Logic mode (see page. 13-15).
- If you turn the speakers off PRO LOGIC goes off as well. When you turn the speakers back on, PRO LOGIC will NOT go back on.
- If you try and turn PRO LOGIC on when the speakes are off, SP OFF will flash on the display, informing you that you can't turn on PRO LOGIC when the speakers are off.
- You can't use the tone controls, or the DIRECT function with PRO LOGIC mode.

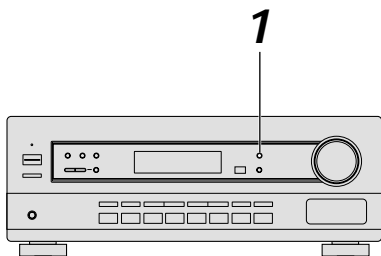

Listening in DVD 5.1 Channel Input Mode

You can use this feature if you have a DVD player and a Dolby Digital decoder or a DVD player with a built-in Dolby Digital decoder. Both these decoders will have separate analog audio outputs for the front left and right, center, surround left and right, and sub-woofer channels. Connect these to the 5.1 channel inputs of the VSX-D209 for enhanced playback of Dolby Digital material—see page 10 for instructions on connecting up. 5.1 channel mode of the VSX-D209 provides better surround-channel sound and overall channel separation than the Dolby Pro Logic mode. Follow the steps below to use the 5.1 channel mode.

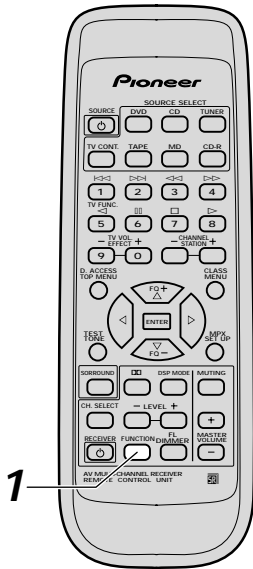

1 Use the FUNCTION button to select DVD 5.1 CH.

On the receiver, press the DVD 5.1 CH function button to select the DVD input mode directly.

On the remote control, repeated presses of the FUNCTION button switches between 5.1 channel input and the other inputs.



- You can input level settings specifically for the 5.1 CH mode and this will enhance your surround sound experience (see p.15).
- You can't use the tone controls S.BASS, or the DIRECT function in 5.1 CH mode.

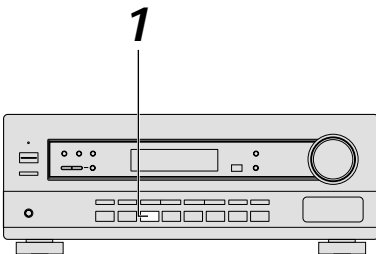

Listening in DSP Mode

The DSP (Digital Signal Processing) modes transform your living room into a variety of different sound environments when playing standard (two channel) stereo sources. Optionally, you can adjust the amount of effect added to the source. The descriptions below give an idea of what the five different modes sound like, but the best idea is to play a source and experiment.

HALL

Simulates the acoustic environment of a large classical concert hall. Long delay and reverb decay times create a sense of music being played in a large space.

JAZZ

Simulates the acoustic environment of a jazz club. Shorter delay times and a tighter reverb help to give the sound a live, small club feel.

DANCE

Simulates the acoustic environment and strong bass sound of a dance music club.

THEATER 1

Simulates the acoustic environment of a mid-sized movie theater.

THEATER 2

Similar to the above but maintains proper localization of each channel.

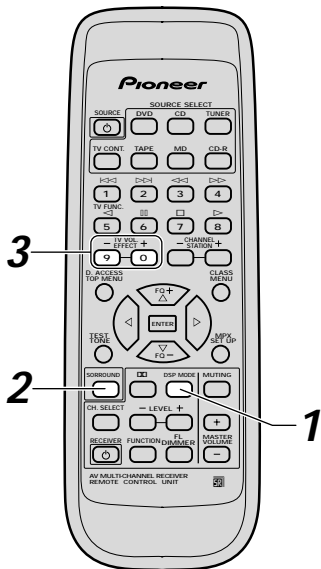

1 Use the DSP MODE button to select a DSP MODE.

Repeated presses of **DSP MODE** changes the DSP mode in the following sequence:

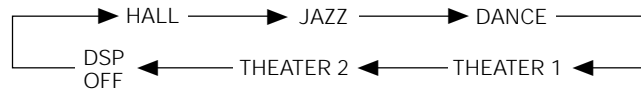

2 Press the SURROUND button.

3 Use the EFFECT +/- buttons to adjust the DSP effect level.

You can adjust the effect level within an range of 10–90 (the default setting is 50).

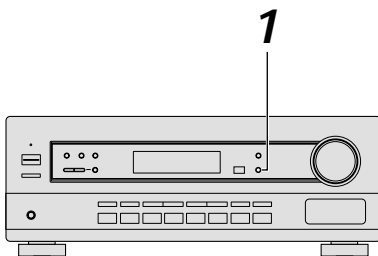

- The settings for effect level in DSP mode are independent of the effect level in **PRO LOGIC THEATER1** and **PRO LOGIC THEATER2** modes.
- You can input level settings specifically for the DSP mode and this will enhance your surround sound experience (see page. 16).
- If you try and turn DSP on when the speakers are off, SP OFF will flash on the display, informing you that you can't turn on DSP when the speakers are off.
- You can't use the tone controls, or the DIRECT function with DSP mode.

Finding a Station

The following steps show you how to tune in to FM and AM radio broadcasts using the automatic (search) and manual (step) tuning functions. If you already know the exact frequency of the station you want to listen to, see Tuning Directly to a Station on the following page. Once you are tuned to a station you can memorize the frequency for recall later—see Memorizing Stations on page 24 for more on how to do this.

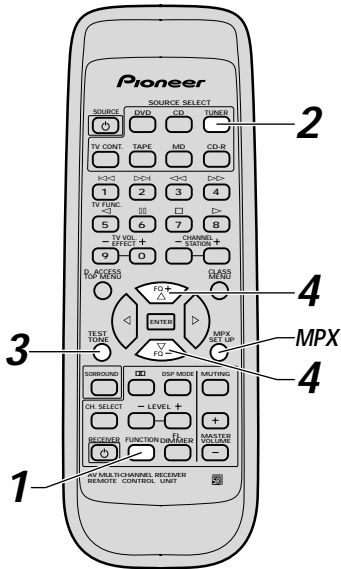

1 Use the **FUNCTION** button to put the receiver in tuner mode .

On the receiver, press the **FM/AM** button to select the tuner mode.

2 Press the **TUNER** button on the remote control to put the remote control in tuner mode.

3 Use the **TEST TONE** button to change the band (**FM** or **AM**), if necessary.

Each press switches the band between FM and AM (on the front panel use the FM/AM button).

4 Tune to a station.

Automatic tuning

To search for stations in the currently selected band, press and hold either the **FQ. +** or **FQ. -** button for about a second. The receiver will start searching for the next station, stopping when it has found one. Repeat this step to search for other stations.

Manual tuning

To change the frequency one step at a time, press the **FQ. + / FQ. -** (**▲▼**) buttons.

To change frequency more quickly, press and hold the **FQ. + / FQ. -** buttons until the desired frequency is reached, then release.

Once you've found a station, you can store it in the receiver's memory for easy recall anytime—turn to page 25 for more on this.

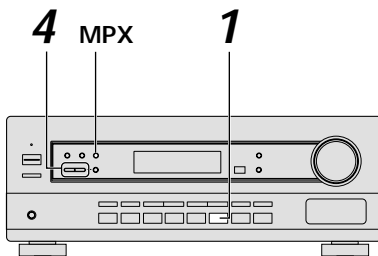

MPX mode

If the **TUNED** or **STEREO** indicators don't light when tuning to an FM station because the signal is weak, press the MPX button to switch the receiver into mono reception mode. This should improve the sound quality and allow you to enjoy the broadcast.

Tuning Directly to a Station

Sometimes, you'll already know the frequency of the station you want to listen. In this case, you can simply enter the frequency directly using the number buttons on the remote control (this function is not available using the front panel controls of the receiver).

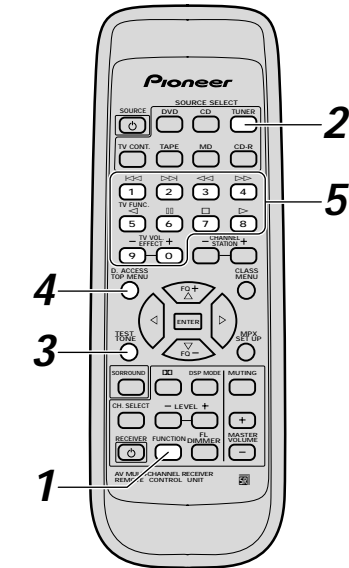

1 Use the FUNCTION button to put the receiver in tuner mode .

On the receiver, press the **FM/AM** button to select the tuner mode.

2 Press the TUNER button on the remote control to put the remote control in tuner mode.

3 Press the TEST TONE button to select either FM or AM.

Each press switches the band between FM and AM. On the receiver, pressing the FM/AM button switches between bands.

4 Press D. ACCESS (DIRECT ACCESS).

5 Use the number buttons to enter the frequency of the radio station.

Example:

To tune to 106.00 (FM), press **1 - 0 - 6 - 0 - 0**

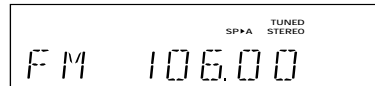
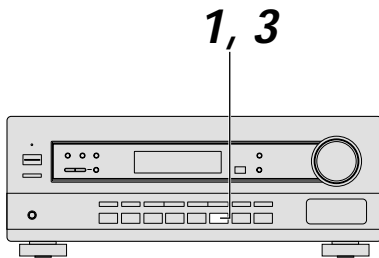

If you make a mistake while inputting the frequency, press the **D.ACCESS** button twice to cancel the frequency and start again.

Memorizing Stations (front panel only)

If you often listen to a particular radio station, it's convenient to have the receiver store the frequency for easy recall whenever you want to listen to that station. This saves the effort of manually tuning in each time. The VSX-D209 can memorize up to 30 stations, stored in three banks, or classes, (A,B and C) of 10 stations each. When memorizing FM frequencies, the receiver also stores the MPX setting (auto stereo or mono, see page.23). The process for memorizing stations is only possible from the controls on the front panel of the receiver.

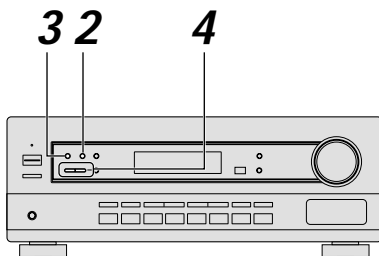

1 Tune to a station you want to memorize.

See Finding a Station and Tuning Directly to a Station, on pages 23 and this page, for more on how to do this.

2 Press MEMORY.

The display shows a blinking memory class.

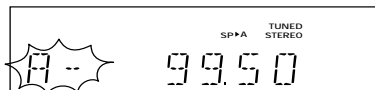

(continues on next page)

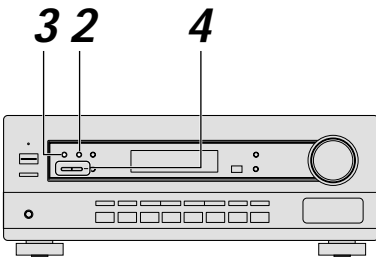

3 Press CLASS to select one of the three classes.

Repeatedly pressing this button cycles through the three available classes, A, B and C.

4 Press STATION +/- to select the desired station memory number.

Pressing these buttons repeatedly cycles through the 10 available station memories in each class. After choosing the location you want, the preset class and number blink for about 5 seconds and the receiver stores the station. **Repeat steps 1 to 4 to memorize up to 30 stations.**

Recalling Memorized Stations

Having memorized up to 30 stations (see the previous page for how to do this), you can be listening to a station with a couple of button presses.

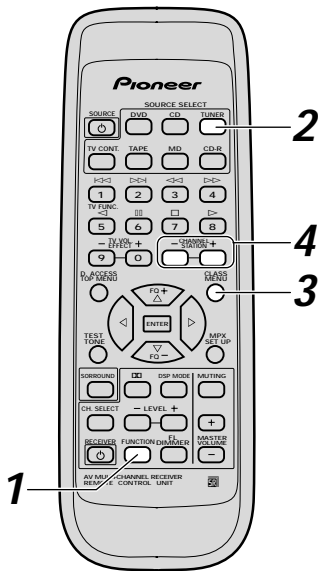

1 Use the FUNCTION button to put the receiver in tuner mode .

On the receiver, press the **FM/AM** button to select the tuner mode.

2 Press the TUNER button on the remote control to put the remote control in tuner mode.

3 Press CLASS to select the class in which the station is stored.

Repeatedly pressing this button cycles through the three available classes, A, B and C.

4 Use the STATION +/- buttons to select the station memory in which the station is stored.

Alternatively, recall the station memory using the number buttons on the remote control.

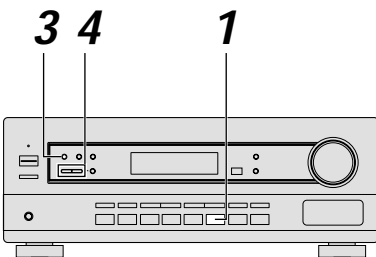

If the receiver is left disconnected from the AC power outlet for a lengthy period, the station memories will be lost and will have to be reprogrammed.

Making a Recording

Making an Audio or a Video Recording

The following steps show you how to make an audio or a video recording from the built in tuner, or from an audio or video source connected to the receiver (such as a CD player or TV). Recordings can be made to a CD-Recorder, cassette deck, MD, VCR, or DVR deck connected to the CD-R/TAPE/MD, VCR or DVR in/out connectors.



The receiver's volume, balance tone (bass, treble, S.bass), and surround effects (Dolby Pro Logic and DSP settings) have no effect on the recorded signal.

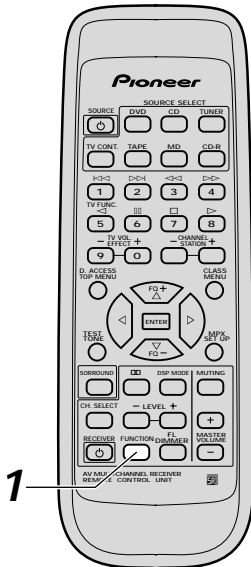

1 Press the **FUNCTION** button to select a source to record.

All functions except MONITOR are accessible from the remote control.

On the receiver, select the source directly using the front panel buttons.

2 Prepare the program source.

Tune to the radio station, load the CD, etc. For a video recording load the video, DVD etc.

3 Insert a blank tape, MD, video etc. into the recording device connected to either **CD-R/TAPE/MD** or **VCR/DVR** and set the recording levels.

Refer to the instructions that came with the recorder if you are unsure how to do this. Most video recorders set the audio recording level automatically—check your video's instruction manual if you are unsure whether yours has manual controls.

4 Start recording, then start playback of the source component.

Record **MONITOR**

You can listen to (monitor) the recording as it's being made using the **MONITOR** button on the Front Panel (a cassette deck would have to have a record monitor function).

Press the **MONITOR** button to switch between the recorded signal and the original source signal.

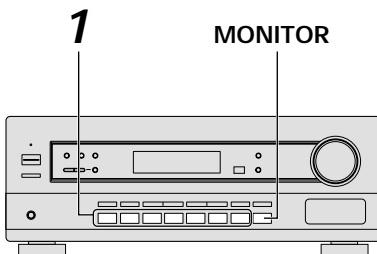

Controlling the Rest of Your System

CD/MD/CD-R Player Controls



This remote control can control Pioneer CD, MD or CD-R decks.

To control your CD, MD or CD-R player with this remote control, first put the remote into CD, MD or CD-R mode with the proper SOURCE SELECT button (i.e. the CD, MD, or CD-R button).

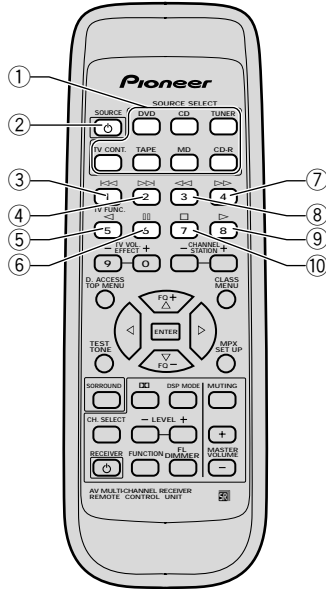

- 1 Use SOURCE SELECT buttons to put the remote control in the stated mode.

- 2 **SOURCE** (power)
Press to switch the CD, MD or CD-R player between **STANDBY** and **ON**.
- 3 **TV FUNC.**
Press to return to the start of the current track. Repeated presses skips to the start of previous tracks.
- 4 **TV VOL +/-**
Press to advance to the start of the next track. Repeated presses skips to the start of following tracks.
- 5 **TV CHAN +/-**
This button has no function.
- 6 **TV FREQ +/-**
Press to pause playback.
- 7 **TV TUNER**
Hold down for fast forward playback.
- 8 **TV STATION +/-**
Hold down for fast reverse playback.
- 9 **TV SEARCH +/-**
Press to start playback.
- 10 **TV MEMORY**
Press to stop playback (on some models, pressing this when the disc is already stopped will cause the disc tray to open).

TV Controls



This remote control can control Pioneer TVs.

To control your TV with this remote control, first put the remote into TV mode with the TV CONT SOURCE SELECT button.

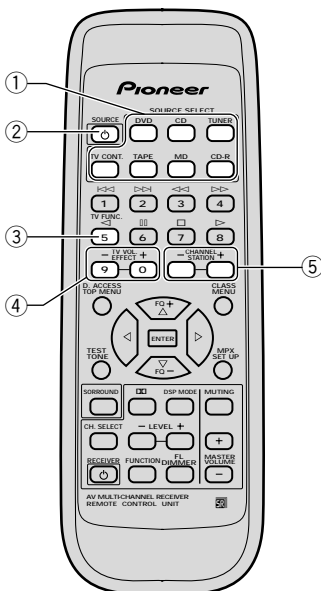

- 1 Use SOURCE SELECT buttons to put the remote control in the stated mode.
- 2 **SOURCE** (power)
Press to switch the TV or CATV between **STANDBY** and **ON**.
- 3 **TV CONT (TV only)**
Press to switch the TV input (not possible with all models)..
- 4 **TV VOL +/-**
Use to adjust the TV volume.
- 5 **CHANNEL +/-**
Use to select channels.

Cassette Deck Controls



This remote control can control Pioneer cassette decks.

To control your cassette deck with this remote control, first put the remote into the TAPE mode with the TAPE SOURCE SELECT button.

For regular cassette decks use buttons ③-⑩ below for the tape control functions. For double deck models, use buttons ③-⑩ to control deck 2 and buttons ⑪-⑫ to control deck 1.

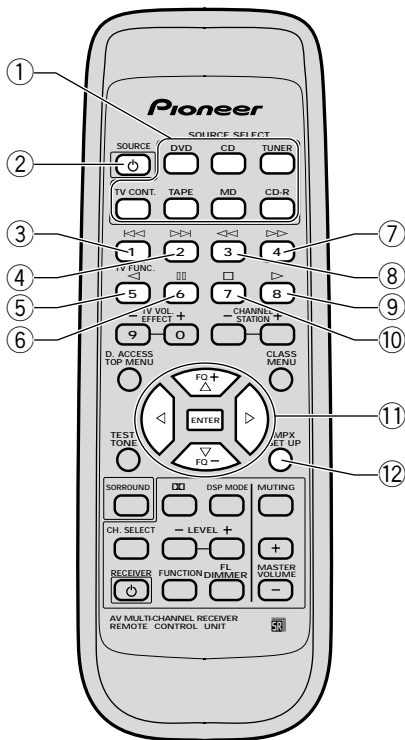

- ① **Use SOURCE SELECT buttons to put the remote control in the stated mode.**
- ② **SOURCE**
Press to switch the cassette deck between STANDBY and ON (not possible on all models).
- ③
This button has no function in cassette deck mode.

- ④
This button has no function in cassette deck mode.
- ⑤
Press to start playback of reverse side of tape (auto reverse models only).
- ⑥
Press to pause playback or recording.
- ⑦
Press to fast forward the tape. Pressing during playback starts forward search.
- ⑧
Press to rewind the tape. Pressing during playback starts reverse search.
- ⑨
Press to start playback.
- ⑩
Press to stop playback.
- ⑪ :
Press to fast forward the tape. Pressing during playback starts forward search.
- :
Press to rewind the tape. Pressing during playback starts reverse search.
- ENTER (■)** : Press to stop playback, etc.
- : Press to start playback of reverse side of tape (auto-reverse models only).
- : Press to start playback.
- ⑫ **MPX/SETUP (||)**
Press to pause playback or recording.

DVD Player Controls



This remote control can control Pioneer DVD players.

To control your DVD player with this remote control, first put the remote into DVD mode with the DVD SOURCE SELECT button.

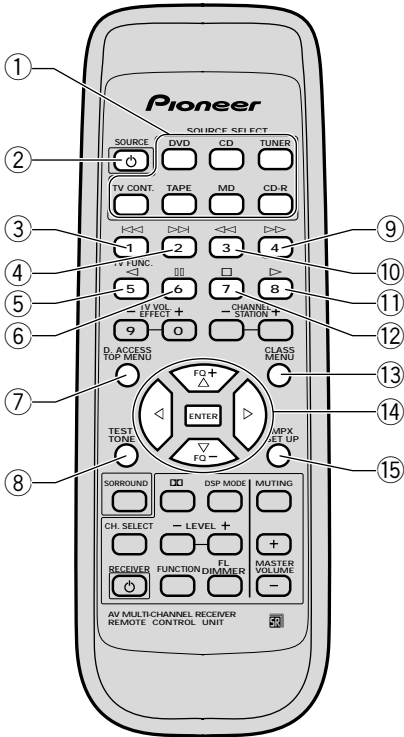

① **Use SOURCE SELECT buttons to put the remote control in the stated mode.**

② **SOURCE (power)**

Press to switch the DVD/LD player between STANDBY and ON.

③

Press to return to the start of the current chapter (track). Repeated presses skips to the start of previous tracks.

④

Press to advance to the start of the next chapter (track). Repeated presses skips to the start of following tracks.

⑤

Use to switch the language on discs that feature multilingual soundtracks (on some models this will switch the angle).

⑥

Press to pause playback (on some models this will freeze-frame the picture).

⑦ **TOP MENU**

Use to display or close the top menu screen

⑧ **AUDIO**

Press repeatedly to select one of the audio languages and or audio formats programmed on a DVD.

⑨

Hold down for fast forward playback.

⑩

Hold down for fast reverse playback.

⑪

Press to start playback (on some models, pressing this when the disc tray is empty will cause the disc tray to open).

⑫

Press to stop playback (on some models, pressing this when the disc is already stopped will cause the disc tray to open).

⑬ **MENU**

Displays menus for adjusting default settings of picture quality, etc.

⑭ : up

: down

ENTER

: left

: right

⑮ **SET UP**

Press when the player is in either play or stop mode to open and close the Setup screen.

Troubleshooting

Incorrect operation is often mistaken for trouble and malfunctions. If you think that there is something wrong with this component, check the points below. Sometimes the trouble may lie in another component. Investigate the other components and electrical appliances being used. If the trouble cannot be rectified even after exercising the checks listed below, ask your nearest Pioneer authorized service center or your dealer to carry out repair work.

Symptom	Cause	Remedy
The power does not turn on.	<ul style="list-style-type: none"> The power plug is disconnected. The protection circuit may have activated. 	<ul style="list-style-type: none"> Connect the power plug to the wall outlet. Disconnect the power plug from the outlet, and insert again.
The unit does not respond when the buttons are pressed.	<ul style="list-style-type: none"> Static electricity caused by dry air. 	<ul style="list-style-type: none"> Disconnect the power plug from the outlet, and insert again.
No sound is output when a function is set.	<ul style="list-style-type: none"> Improper connections. Sound is muted. The volume is turned down. Speakers are turned off. Monitor is on. 	<ul style="list-style-type: none"> Make sure the component is connected correctly (see pages 8 through 11). Press MUTING on the remote control. Adjust MASTER VOLUME. Press SPEAKERS to switch on the speakers. Press the MONITOR button.
No image is output when a function is set.	<ul style="list-style-type: none"> Improper connections. The input source is not properly selected. 	<ul style="list-style-type: none"> Make sure the component is connected correctly (see pages 8 through 11). Press the correct function button.
Considerable noise in radio broadcasts	<ul style="list-style-type: none"> Incorrect frequency. The antenna is not connected. 	<ul style="list-style-type: none"> Tune in the correct frequency. Connect the antenna (see page 8).
FM broadcasts		
	<ul style="list-style-type: none"> The FM antenna is not fully extended or poorly positioned. Weak radio signal. 	<ul style="list-style-type: none"> Fully extend the FM wire antenna, position for best reception, and secure to a wall. Connect an outdoor FM antenna. (see page 8).
AM broadcasts		
	<ul style="list-style-type: none"> The AM antenna is poorly positioned. Weak radio signal. Interference cause by other equipment (fluorescent lamp, motor, etc.). 	<ul style="list-style-type: none"> Adjust the direction and position for best reception. Connect an additional internal or external AM antenna (see page 8). Turn off the equipment causing the noise or move it away from the receiver. Place the antenna farther away from the equipment causing the noise.
Broadcast stations cannot be selected automatically.	<ul style="list-style-type: none"> Weak radio signal. 	<ul style="list-style-type: none"> Connect an outdoor antenna (see page 8).
No sound from surround or center speakers.	<ul style="list-style-type: none"> Incorrect center mode. The surround and/or center levels are turned down. The surround and/or center speakers are disconnected. 	<ul style="list-style-type: none"> Set the correct center mode according to the speakers in your system (see page 13). See Setting Volume Levels on page 15-16 to check the speaker levels. Connect the speakers (see pages 11-12).

Symptom	Cause	Remedy
Cannot be remote controlled.	<ul style="list-style-type: none"> The remote control unit batteries have worn out. Too far away or bad angle of operation. There is an obstacle between the receiver and the remote control. Strong light such as fluorescent light is shining onto the unit's remote control signal light-receiving window. 	<ul style="list-style-type: none"> Replace the batteries (see page 7). Operate within 7 m, 30° of the remote sensor on the front panel (see page 7). Remove the obstacle or operate from another position. Avoid exposing the remote sensor on the front panel to direct light.

If the unit does not operate normally due to external effects such as static electricity

- Disconnect the power plug from the outlet and insert again to return to normal operating conditions.

Specifications

Amplifier Section

Continuous average power output of 60 watts* per channel, min., at 8 ohms, from 40 Hz to 20,000 Hz with no more than 0.09 % total harmonic distortion (front).**

Continuous Power Output

Front 60 W + 60 W (1kHz, 0.9 %, 8 Ω)
 Center 60 W (1kHz, 0.9 %, 8 Ω)
 Surround 60 W + 60 W (1kHz, 0.9 %, 8 Ω)

Input (Sensitivity/Impedance)

CD, VCR/DVR, CD-R/TAPE/MD, DVD/LD, TV/SAT
 200 mV/47 kΩ

Frequency Response

CD, VCR/DVR, CD-R/TAPE/MD, DVD/LD, TV/SAT
 5 Hz to 100,000 Hz

Output (Level/Impedance)

VCR/DVR REC, CD-R/TAPE/MD REC
 200 mV/2.2 kΩ

Tone Control

BASS ± 6 dB (100 Hz)
 TREBLE ± 6 dB (10 kHz)
 S.BASS + 8 dB (100 Hz)

Signal-to-Noise Ratio (IHF, short circuited, A network)

CD, VCR/DVR, CD-R/TAPE/MD, DVD/LD, TV/SAT
 96 dB

Signal to Noise Ratio [EIA, at 1 W (1 kHz)]

CD, VCR/DVR, CD-R/TAPE/MD, DVD/LD, TV/SAT
 79 dB

* Measured pursuant to the Federal Trade Commission's Trade Regulation rule on Power Output Claims for Amplifiers.
 ** Measured by Audio Spectrum Analyzer.

Video Section

Input (Sensitivity/Impedance)

VCR/DVR, DVD/LD, TV/SAT 1 Vp-p/75 Ω

Output (Level/Impedance)

VCR/DVR 1 Vp-p/75 Ω

Frequency Response

VCR/DVR, DVD/LD, TV/SAT → MONITOR
 5 Hz to 7 MHz ⁺⁰₋₃ dB

Signal-to-Noise Ratio 55 dB

Cross Talk 55 dB

FM Tuner Section

Frequency Range 87.5 MHz to 108 MHz

Usable Sensitivity
 Mono:13.2 dBf, IHF (1.3 μV/75 Ω)

50 dB Quieting Sensitivity Mono: 20.2 dB

Stereo: 38.6 dBf

Signal-to-Noise Ratio Mono: 76 dB (at 85 dBf)

Stereo: 72 dB (at 85 dBf)

Distortion Stereo: 0.5 % (1 kHz)

Alternate Channel Selectivity 60 dB (400 kHz)

Stereo Separation 40 dB (1 kHz)

Frequency Response 30 Hz to 15 kHz (±1) dB

Antenna Input 75 Ω unbalanced

AM Tuner Section

Frequency Range 530 kHz to 1,700 kHz

Sensitivity (IHF, Loop antenna) 350 μV/m

Selectivity 25 dB

Signal-to-Noise Ratio 50 dB

Antenna Loop antenna

Miscellaneous

Power Requirements AC 120 V, 60 Hz

Power Consumption 180 W

In Standby 1 W

Dimensions 420 (W) x 158 (H) x 391 (D) mm

(16-9/16 (W) x 6-4/16 (H) x 15-7/16 (D) in.)

Weight (without package) 8.4 kg (18 lb 9 oz)

Furnished Parts

FM Antenna 1

AM Loop Antenna 1

Dry Cell Batteries

size AA (IEC R6P) 2

Remote Control Unit 1

Operating Instructions 1

NOTE:

Specifications and the design are subject to possible modifications without notice, due to improvements.



We Want You Listening For A Lifetime

Dear Customer:

Selecting fine audio equipment such as the unit you've just purchased is only the start of your musical enjoyment. Now it's time to consider how you can maximize the fun and excitement your equipment offers. This manufacturer and the Electronic Industries Association's Consumer Electronics Group want you to get the most out of your equipment by playing it at a safe level. One that lets the sound come through loud and clear without annoying blaring or distortion-and, most importantly, without affecting your sensitive hearing.

Sound can be deceiving. Over time your hearing "comfort level" adapts to higher volumes of sound. So what sounds "normal" can actually be loud and harmful to your hearing. Guard against this by setting your equipment at a safe level BEFORE your hearing adapts.

To establish a safe level:

- Start your volume control at a low setting.
- Slowly increase the sound until you can hear it comfortably and clearly, and without distortion.

Once you have established a comfortable sound level:

- Set the dial and leave it there.

Taking a minute to do this now will help to prevent hearing damage or loss in the future. After all, we want you listening for a lifetime.

Used wisely, your new sound equipment will provide a lifetime of fun and enjoyment. Since hearing damage from loud noise is often undetectable until it is too late, this manufacturer and the Electronic Industries Association's Consumer Electronics Group recommend you avoid prolonged exposure to excessive noise. This list of sound levels is included for your protection.

Decibel

Level	Example
30	Quiet library, soft whispers
40	Living room, refrigerator, bedroom away from traffic
50	Light traffic, normal conversation, quiet office
60	Air conditioner at 20 feet, sewing machine
70	Vacuum cleaner, hair dryer, noisy restaurant
80	Average city traffic, garbage disposals, alarm clock at two feet.

THE FOLLOWING NOISES CAN BE DANGEROUS UNDER CONSTANT EXPOSURE

90	Subway, motorcycle, truck traffic, lawn mower
100	Garbage truck, chain saw, pneumatic drill
120	Rock band concert in front of speakers, thunderclap
140	Gunshot blast, jet plane
180	Rocket launching pad

Information courtesy of the Deafness Research Foundation.



Should this product require service in the U.S.A. and you wish to locate the nearest Pioneer Authorized Independent Service Company, or if you wish to purchase replacement parts, operating instructions, service manuals, or accessories, please call the number shown below.

8 0 0 - 4 2 1 - 1 4 0 4

Please do not ship your product to Pioneer without first calling the Customer Service Department at the above listed number for assistance.

PIONEER ELECTRONICS SERVICE, INC.
CUSTOMER SERVICE DEPARTMENT
P.O. BOX 1760, LONG BEACH,
CA 90801-1760, U.S.A.

For warranty information please see the Limited Warranty sheet included with your product.

Published by Pioneer Corporation.
Copyright © 1999 Pioneer Electronic Corporation.
All rights reserved.

PIONEER CORPORATION 4-1, Meguro 1-Chome, Meguro-ku, Tokyo 153-8654, Japan
PIONEER ELECTRONICS [USA] INC. P.O. BOX 1540, Long Beach, California 90801-1540, U.S.A.
PIONEER ELECTRONICS OF CANADA, INC. 300 Allstate Parkway, Markham, Ontario L3R 0P2, Canada
PIONEER ELECTRONIC [EUROPE] N.V. Haven 1087, Keetberglaan 1, 9120 Melsele, Belgium TEL: 03/570.05.11
PIONEER ELECTRONICS AUSTRALIA PTY. LTD. 178-184 Boundary Road, Braeside, Victoria 3195, Australia, TEL: [03] 9586-6300
PIONEER ELECTRONICS DE MEXICO S.A. DE C.V. San Lorenzo Num 1009 3er piso Desp. 302 Col. Del Valle, Mexico D.F. C.P. 03100
 TEL:5-688-52-90