



Photoelectric sensors
V180-2, Photoelectric proximity sensor,
Background blanking

VTF180-2F32412



Type > [VTF180-2F32412](#)
Part No. > [6044021](#)



Illustration may differ

At a glance

- Lowest-cost M18 housing sensor on the market
- Sensing distance up to 140 mm
- Bright power and signal LEDs with 360° visibility
- High switching frequencies up to 1000 Hz
- Available in a metal housing for applications in harsh environments
- Optical axis selectively axial or radial (90°)
- Wide product portfolio solves a broad range of applications

Your benefits

- Lowest-cost M18 cylindrical sensor on the market reduces installation costs
- Bright red sender LED simplifies alignment and saves installation time
- Bright power and signal LEDs with 360° visibility offer quick and simple troubleshooting, reducing maintenance time and costs
- The flat and smooth lens reduces the collection of dust and dirt, ensuring safe operation with less maintenance and fewer costs



Features

Sensor/detection principle:	Photoelectric proximity sensor, Background blanking
Housing design (light emission):	Cylindrical, straight
Housing length:	69.8 mm
Thread diameter (housing):	M18 x 1
Optical axis:	Axial
Sensing range max.:	1 mm ... 140 mm ¹⁾
Sensing range:	1 mm ... 100 mm ²⁾
Type of light:	Visible red light
Light source:	LED ³⁾
Wave length:	645 nm
Focus:	Focused, focus approx. 7 mm at 60 mm
Adjustment:	Potentiometer, 270 °
Light spot size (distance):	Ø 8 mm (100 mm)

^{1) 2)} Object with 90 % reflectance (referred to standard white, DIN 5033) ³⁾ Average service life of 100,000 h at T_A = +25 °C

Mechanics/electronics

Supply voltage:	10 V DC ... 30 V DC ¹⁾
Ripple:	± 10 % ²⁾

Current consumption:	≤ 30 mA ³⁾
Output type:	PNP, open collector
Switching mode:	Light switching
Output current I _{max} :	≤ 100 mA
Response time:	≤ 0.5 ms ⁴⁾
Switching frequency:	± 1,000 Hz ⁵⁾
Connection type:	Connector M12, 3-pin
Circuit protection:::	A, B, D ^{6) 7) 8)}
Protection class:	III
Weight:	47 g
Housing material:	Nickel-plated brass and PC, Metal
Optics material:	PMMA
Enclosure rating:	IP 67
Items supplied:	Fastening nuts (2 x)
Special feature:	Focused optics
Ambient operating temperature:	-25 °C ... +55 °C
Ambient storage temperature:	-40 °C ... +70 °C
Signal voltage PNP HIGH/LOW:	Approx. VS - 1.8 V/0 V

¹⁾ Limit values, operation in short-circuit protected network max. 8 A ²⁾ May not exceed or fall short of V_S tolerances ³⁾ Without load ⁴⁾ Signal transit time with resistive load ⁵⁾ With light/dark ratio 1:1 ⁶⁾ A = V_S connections reverse-polarity protected ⁷⁾ B = inputs and output reverse-polarity protected ⁸⁾ D = outputs overcurrent and short-circuit protected

Dimensional drawing

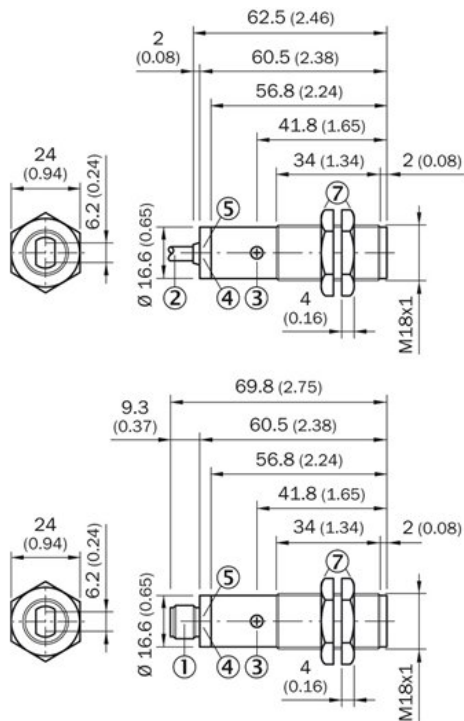

- [1] Connector M12, 4-pin
- [2] Connection cable 2 m
- [3] Sensitivity adjustment 270°
- [4] LED indicator orange: switching output active
- [5] LED indicator green: strength indicator
- [7] fastening nuts (2 x); 24 mm hex, metal

Adjustments possible

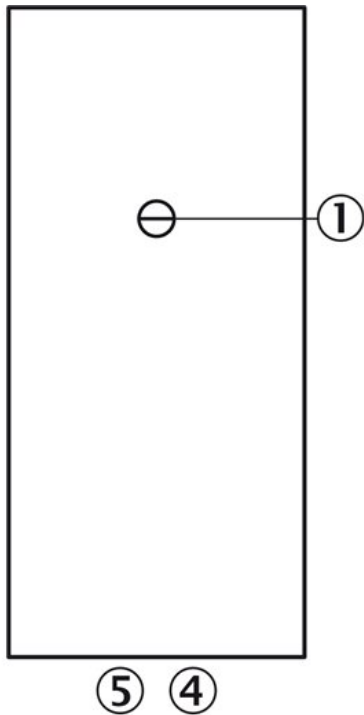

- |3| Sensitivity adjustment 270°
- |4| LED indicator orange: switching output active
- |5| LED indicator green

Connection diagram

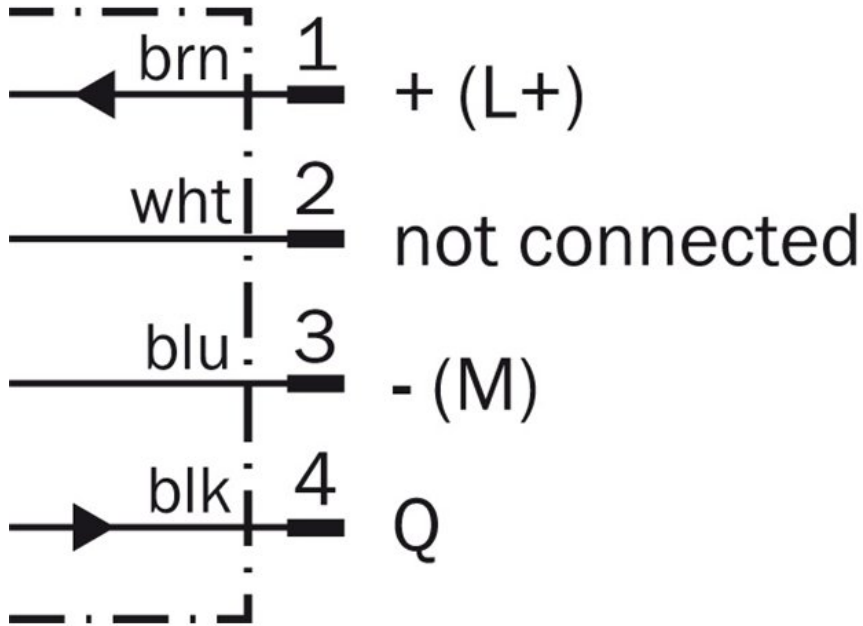

Characteristic curve

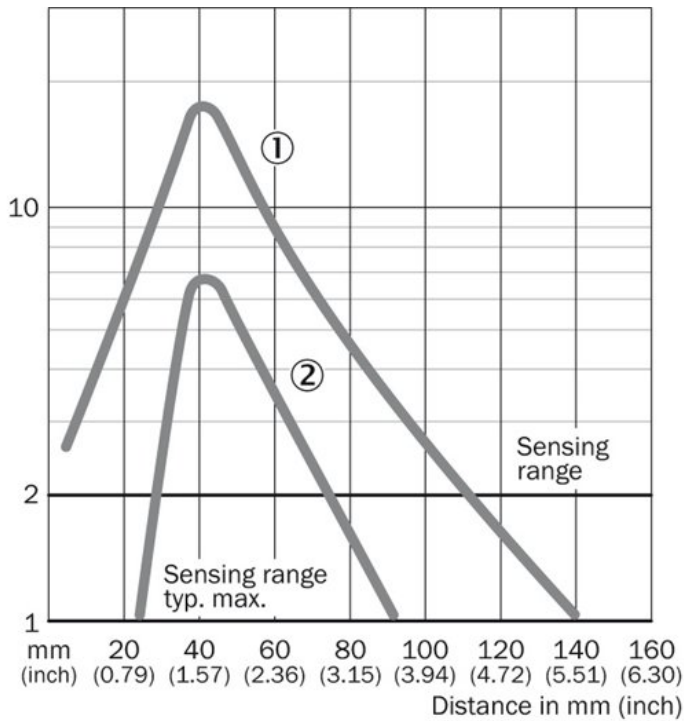

- |1| Sensing range on white, 90 % remission
- |2| Sensing range on grey, 18 % remission

Connection type

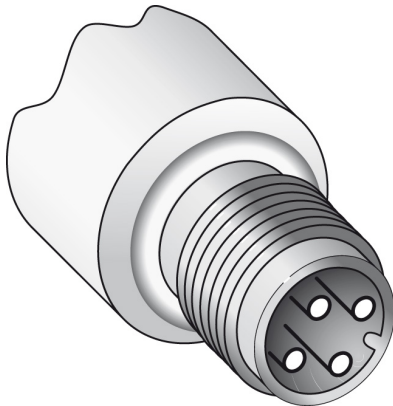

Light spot size

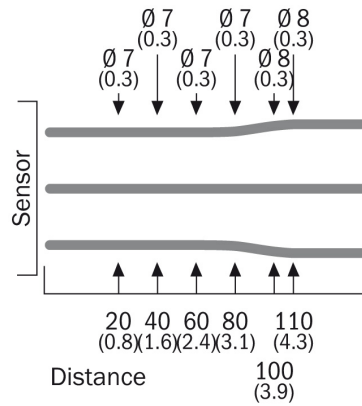

Sensing range diagram

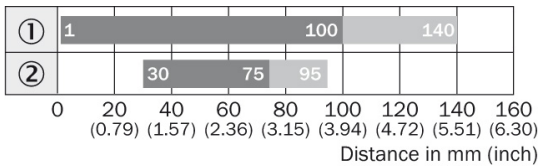

■ Sensing range ■ Sensing range max.

Australia

Phone +61 3 9457 0600
1800 33 48 02 – tollfree
E-Mail sales@sick.com.au

Belgium/Luxembourg

Phone +32 (0)2 466 55 66
E-Mail info@sick.be

Brasil

Phone +55 11 3215-4900
E-Mail marketing@sick.com.br

Canada

Phone +1 905 771 14 44
E-Mail information@sick.com

Česká republika

Phone +420 2 57 91 18 50
E-Mail sick@sick.cz

China

Phone +86 4000 121 000
E-Mail info.china@sick.net.cn
Phone +852-2153 6300
E-Mail ghk@sick.com.hk

Danmark

Phone +45 45 82 64 00
E-Mail sick@sick.dk

Deutschland

Phone +49 211 5301-301
E-Mail info@sick.de

España

Phone +34 93 480 31 00
E-Mail info@sick.es

France

Phone +33 1 64 62 35 00
E-Mail info@sick.fr

Great Britain

Phone +44 (0)1727 831121
E-Mail info@sick.co.uk

India

Phone +91-22-4033 8333
E-Mail info@sick-india.com

Israel

Phone +972-4-6881000
E-Mail info@sick-sensors.com

Italia

Phone +39 02 27 43 41
E-Mail info@sick.it

Japan

Phone +81 (0)3 5309 2112
E-Mail support@sick.jp

Magyarország

Phone +36 1 371 2680
E-Mail office@sick.hu

Nederland

Phone +31 (0)30 229 25 44
E-Mail info@sick.nl

Norge

Phone +47 67 81 50 00
E-Mail sick@sick.no

Österreich

Phone +43 (0)22 36 62 28 8-0
E-Mail office@sick.at

Polska

Phone +48 22 837 40 50
E-Mail info@sick.pl

România

Phone +40 356 171 120
E-Mail office@sick.ro

Russia

Phone +7-495-775-05-30
E-Mail info@sick.ru

Schweiz

Phone +41 41 619 29 39
E-Mail contact@sick.ch

Singapore

Phone +65 6744 3732
E-Mail sales.gsg@sick.com

Slovenija

Phone +386 (0)1-47 69 990
E-Mail office@sick.si

South Africa

Phone +27 11 472 3733
E-Mail info@sickautomation.co.za

South Korea

Phone +82 2 786 6321/4
E-Mail info@sickkorea.net

Suomi

Phone +358-9-25 15 800
E-Mail sick@sick.fi

Sverige

Phone +46 10 110 10 00
E-Mail info@sick.se

Taiwan

Phone +886 2 2375-6288
E-Mail sales@sick.com.tw

Türkiye

Phone +90 (216) 528 50 00
E-Mail info@sick.com.tr

United Arab Emirates

Phone +971 (0) 4 88 65 878
E-Mail info@sick.ae

USA/México

Phone +1(952) 941-6780
1 (800) 325-7425 – tollfree
E-Mail info@sickusa.com

More representatives and agencies
at www.sick.com