

Standard Rectifier Module

| |
|---------------------------|
| 3~ Rectifier |
| $V_{RRM} = 1600\text{ V}$ |
| $I_{DAV} = 240\text{ A}$ |
| $I_{FSM} = 2800\text{ A}$ |

3~ Rectifier Bridge

Part number

VUO190-16NO7

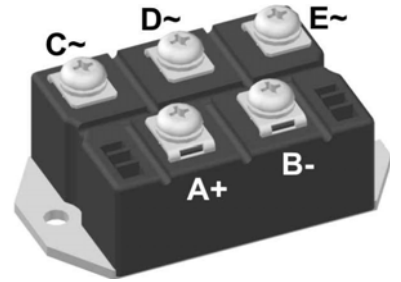

E72873

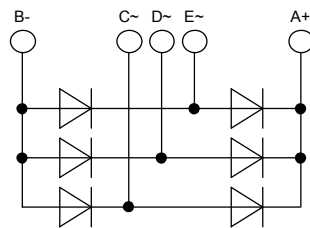

Features / Advantages:

- Package with DCB ceramic
- Improved temperature and power cycling
- Planar passivated chips
- Very low forward voltage drop
- Very low leakage current

Applications:

- Diode for main rectification
- For three phase bridge configurations
- Supplies for DC power equipment
- Input rectifiers for PWM inverter
- Battery DC power supplies
- Field supply for DC motors

Package: PWS-E

- Industry standard outline
- RoHS compliant
- Easy to mount with two screws
- Base plate: Copper internally DCB isolated
- Advanced power cycling

| Rectifier | | | | Ratings | | | |
|------------|--|--|---|--------------------------|------|------|-------------------|
| Symbol | Definition | Conditions | | min. | typ. | max. | Unit |
| V_{RSM} | max. non-repetitive reverse blocking voltage | | | | | 1700 | V |
| V_{RRM} | max. repetitive reverse blocking voltage | | | | | 1600 | V |
| I_R | reverse current | $V_R = 1600$ V | $T_{VJ} = 25^\circ\text{C}$ | | | 200 | μA |
| | | $V_R = 1600$ V | $T_{VJ} = 150^\circ\text{C}$ | | | 3.5 | mA |
| V_F | forward voltage drop | $I_F = 80$ A | $T_{VJ} = 25^\circ\text{C}$ | | | 1.07 | V |
| | | $I_F = 240$ A | | | | 1.36 | V |
| | | $I_F = 80$ A | $T_{VJ} = 125^\circ\text{C}$ | | | 0.96 | V |
| | | $I_F = 240$ A | | | | 1.33 | V |
| I_{DAV} | bridge output current | $T_C = 110^\circ\text{C}$ rectangular | $T_{VJ} = 150^\circ\text{C}$ $d = \frac{1}{3}$ | | | 240 | A |
| V_{FO} | threshold voltage | } for power loss calculation only | | | | 0.74 | V |
| r_F | slope resistance | | | | | 2.4 | m Ω |
| R_{thJC} | thermal resistance junction to case | | | | | 0.4 | K/W |
| R_{thCH} | thermal resistance case to heatsink | | | 0.15 | | | K/W |
| P_{tot} | total power dissipation | | | $T_C = 25^\circ\text{C}$ | | 310 | W |
| I_{FSM} | max. forward surge current | $t = 10$ ms; (50 Hz), sine | $T_{VJ} = 45^\circ\text{C}$ | | | 2.80 | kA |
| | | $t = 8,3$ ms; (60 Hz), sine | $V_R = 0$ V | | | 3.03 | kA |
| | | $t = 10$ ms; (50 Hz), sine | $T_{VJ} = 150^\circ\text{C}$ | | | 2.38 | kA |
| | | $t = 8,3$ ms; (60 Hz), sine | $V_R = 0$ V | | | 2.57 | kA |
| I^2t | value for fusing | $t = 10$ ms; (50 Hz), sine | $T_{VJ} = 45^\circ\text{C}$ | | | 39.2 | kA ² s |
| | | $t = 8,3$ ms; (60 Hz), sine | $V_R = 0$ V | | | 38.1 | kA ² s |
| | | $t = 10$ ms; (50 Hz), sine | $T_{VJ} = 150^\circ\text{C}$ | | | 28.3 | kA ² s |
| | | $t = 8,3$ ms; (60 Hz), sine | $V_R = 0$ V | | | 27.5 | kA ² s |
| C_J | junction capacitance | $V_R = 400$ V; $f = 1$ MHz | $T_{VJ} = 25^\circ\text{C}$ | | 133 | | pF |

| Package PWS-E | | | Ratings | | | |
|---------------|--|----------------------|---------|------|------|------|
| Symbol | Definition | Conditions | min. | typ. | max. | Unit |
| I_{RMS} | RMS current | per terminal | | | 250 | A |
| T_{stg} | storage temperature | | -40 | | 125 | °C |
| T_{VJ} | virtual junction temperature | | -40 | | 150 | °C |
| Weight | | | | 284 | | g |
| M_D | mounting torque | | 4.25 | | 5.75 | Nm |
| M_T | terminal torque | | 4.25 | | 5.75 | Nm |
| $d_{Spp/App}$ | creepage distance on surface striking distance through air | terminal to terminal | 12.0 | | | mm |
| $d_{Spb/Apb}$ | | terminal to backside | 26.0 | | | mm |
| V_{ISOL} | isolation voltage | t = 1 second | 3000 | | | V |
| | | t = 1 minute | 2500 | | | V |

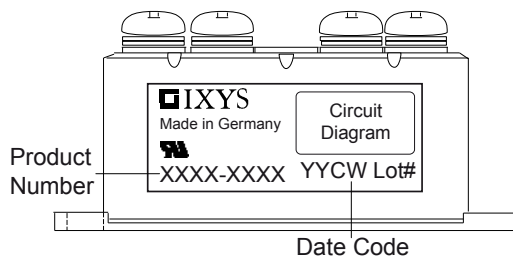

| Ordering | Part Number | Marking on Product | Delivery Mode | Quantity | Code No. |
|----------|--------------|--------------------|---------------|----------|----------|
| Standard | VUO190-16NO7 | VUO190-16NO7 | Box | 5 | 462519 |

Equivalent Circuits for Simulation

* on die level

$T_{VJ} = 150\text{ °C}$

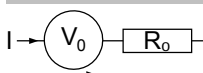

Rectifier

| | | | |
|-------------|--------------------|------|----|
| $V_{0\max}$ | threshold voltage | 0.74 | V |
| $R_{0\max}$ | slope resistance * | 1.2 | mΩ |

Outlines PWS-E

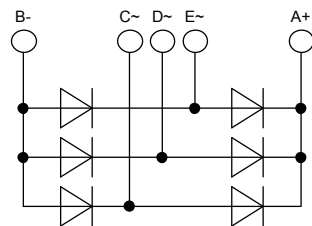
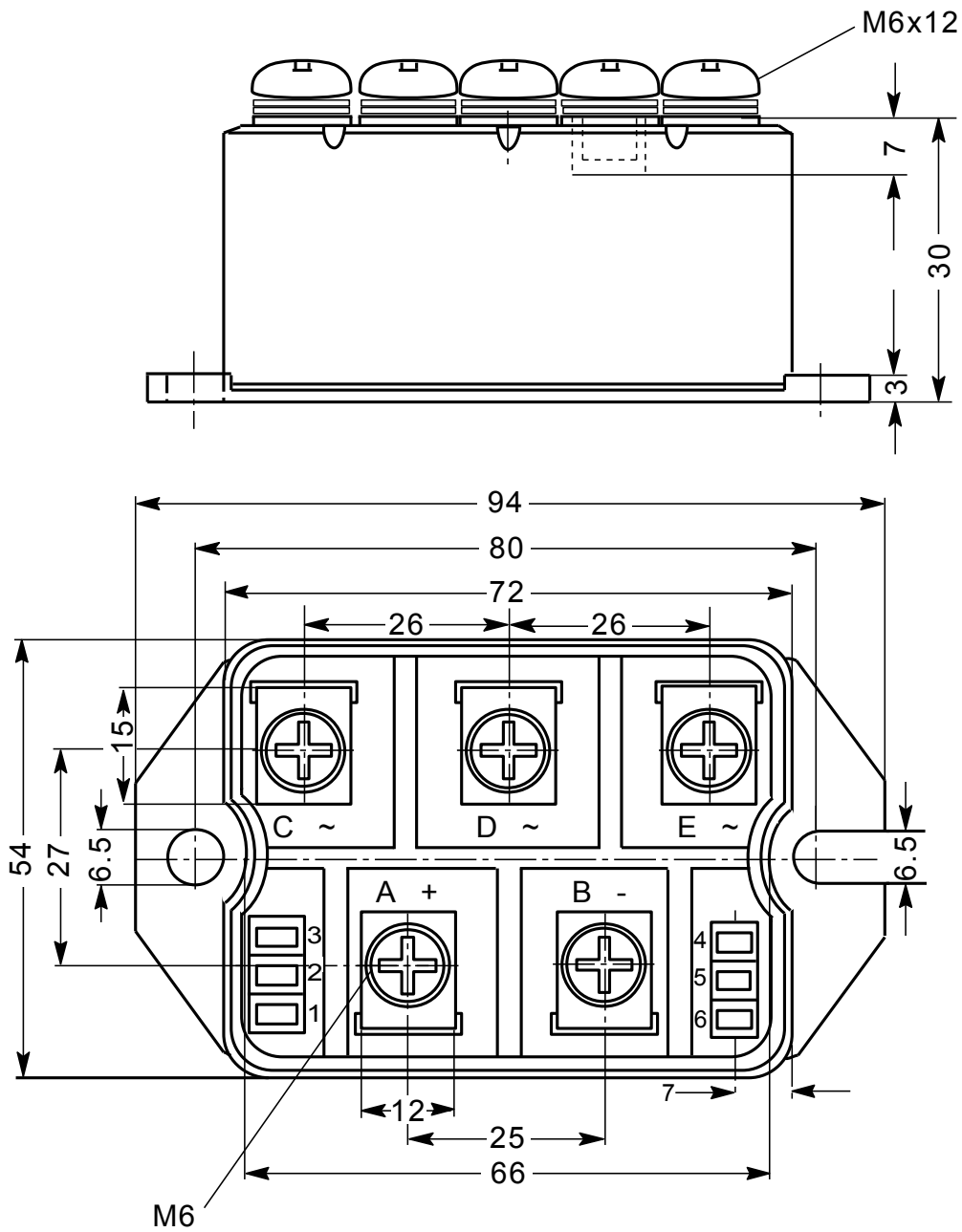

Rectifier

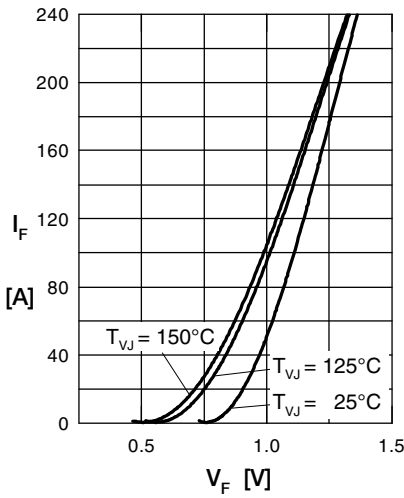

Fig. 1 Forward current vs. voltage drop per diode

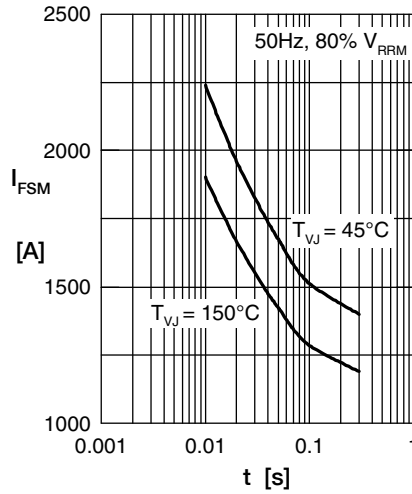

Fig. 2 Surge overload current vs. time per diode

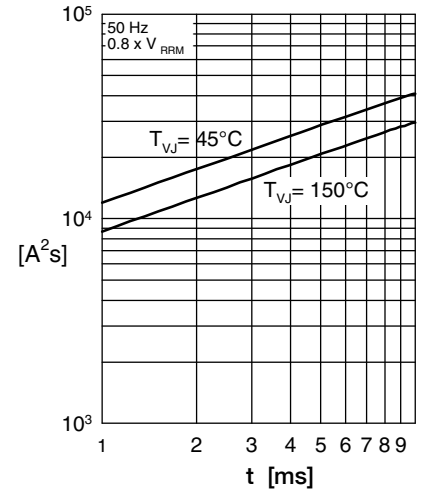

Fig. 3 I^2t vs. time per diode

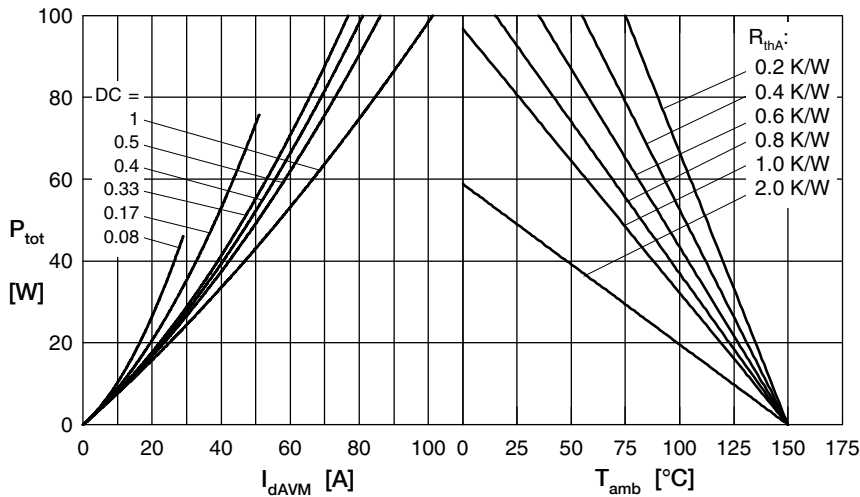

Fig. 4 Power dissipation vs. forward current and ambient temperature per diode

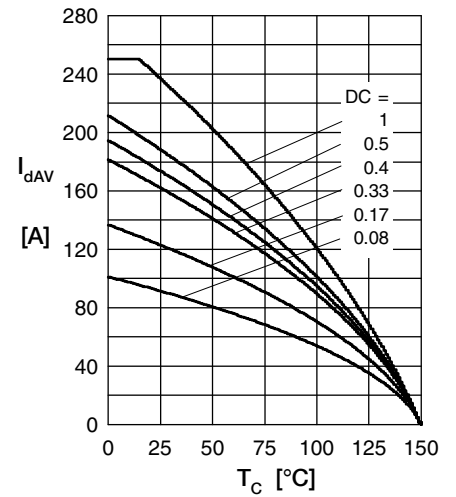

Fig. 5 Max. forward current vs. case temperature per diode

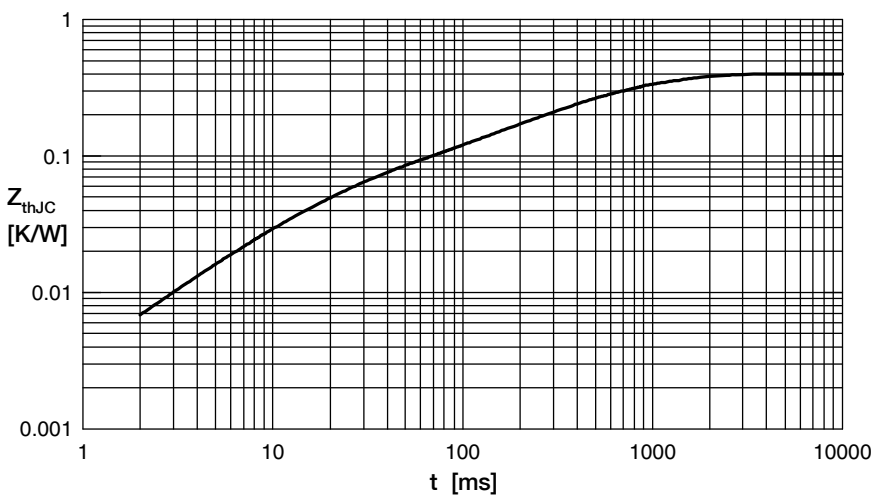

Fig. 6 Transient thermal impedance junction to case vs. time per diode

| R_i | t_i |
|-------|-------|
| 0.050 | 0.02 |
| 0.003 | 0.01 |
| 0.100 | 0.225 |
| 0.177 | 0.8 |
| 0.070 | 0.58 |