

Standard Rectifier Module

3~ Rectifier	
V_{RRM}	= 800 V
I_{DAV}	= 45 A
I_{FSM}	= 300 A

3~ Rectifier Bridge

Part number

VUO30-18NO3

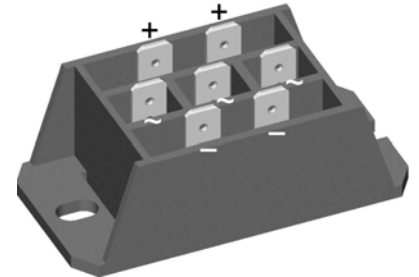

 E72873

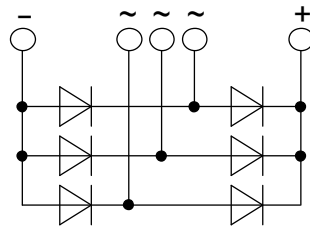

Features / Advantages:

- Package with DCB ceramic
- Reduced weight
- Improved temperature and power cycling
- Planar passivated chips
- Very low forward voltage drop
- Very low leakage current

Applications:

- Diode for main rectification
- For three phase bridge configurations
- Supplies for DC power equipment
- Input rectifiers for PWM inverter
- Battery DC power supplies
- Field supply for DC motors

Package: FO-F-B

- Isolation Voltage: 3600V~
- Industry standard outline
- RoHS compliant
- ¼" fast-on terminals
- Easy to mount with two screws
- Base plate: DCB ceramic
- Reduced weight
- Advanced power cycling

Rectifier				Ratings		
Symbol	Definition	Conditions	min.	typ.	max.	Unit
V_{RSM}	max. non-repetitive reverse blocking voltage	$T_{VJ} = 25^{\circ}C$			900	V
V_{RRM}	max. repetitive reverse blocking voltage	$T_{VJ} = 25^{\circ}C$			800	V
I_R	reverse current	$V_R = 800 V$	$T_{VJ} = 25^{\circ}C$		40	μA
		$V_R = 800 V$	$T_{VJ} = 150^{\circ}C$		1.5	mA
V_F	forward voltage drop	$I_F = 15 A$	$T_{VJ} = 25^{\circ}C$		1.10	V
					1.38	V
		$I_F = 45 A$	$T_{VJ} = 125^{\circ}C$		1.01	V
					1.38	V
I_{DAV}	bridge output current	$T_C = 110^{\circ}C$	$T_{VJ} = 150^{\circ}C$		45	A
		rectangular $d = \frac{1}{3}$				
V_{FO}	threshold voltage		$T_{VJ} = 150^{\circ}C$		0.80	V
r_F	slope resistance				12.9	m Ω
R_{thJC}	thermal resistance junction to case				2	K/W
R_{thCH}	thermal resistance case to heatsink			0.4		K/W
P_{tot}	total power dissipation		$T_C = 25^{\circ}C$		60	W
I_{FSM}	max. forward surge current	$t = 10 \text{ ms; (50 Hz), sine}$	$T_{VJ} = 45^{\circ}C$		300	A
		$t = 8,3 \text{ ms; (60 Hz), sine}$	$V_R = 0 V$		325	A
		$t = 10 \text{ ms; (50 Hz), sine}$	$T_{VJ} = 150^{\circ}C$		255	A
		$t = 8,3 \text{ ms; (60 Hz), sine}$	$V_R = 0 V$		275	A
I^2t	value for fusing	$t = 10 \text{ ms; (50 Hz), sine}$	$T_{VJ} = 45^{\circ}C$		450	A ² s
		$t = 8,3 \text{ ms; (60 Hz), sine}$	$V_R = 0 V$		440	A ² s
		$t = 10 \text{ ms; (50 Hz), sine}$	$T_{VJ} = 150^{\circ}C$		325	A ² s
		$t = 8,3 \text{ ms; (60 Hz), sine}$	$V_R = 0 V$		315	A ² s
C_J	junction capacitance	$V_R = 400 V; f = 1 \text{ MHz}$	$T_{VJ} = 25^{\circ}C$		10	pF

Package FO-F-B		Ratings				
Symbol	Definition	Conditions	min.	typ.	max.	Unit
I_{RMS}	RMS current	per terminal			100	A
T_{stg}	storage temperature		-40		125	°C
T_{VJ}	virtual junction temperature		-40		150	°C
Weight				45		g
M_D	mounting torque		2		2.5	Nm
$d_{Spp/App}$	creepage distance on surface striking distance through air	terminal to terminal	18.0	6.0		mm
$d_{Spb/Apb}$		terminal to backside	26.0	20.0		mm
V_{ISOL}	isolation voltage	t = 1 second			3600	V
		t = 1 minute	50/60 Hz, RMS; $I_{ISOL} \leq 1$ mA		3000	V



Ordering	Part Number	Marking on Product	Delivery Mode	Quantity	Code No.
Standard	VUO30-18NO3	VUO30-18NO3	Box	10	454362

Equivalent Circuits for Simulation

* on die level

$T_{VJ} = 150^\circ\text{C}$



Rectifier

$V_{0\max}$	threshold voltage	0.8	V
$R_{0\max}$	slope resistance *	11.7	mΩ

Outlines FO-F-B

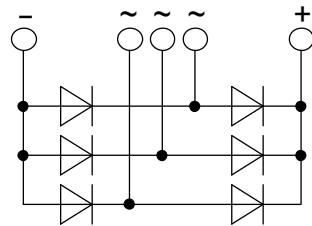
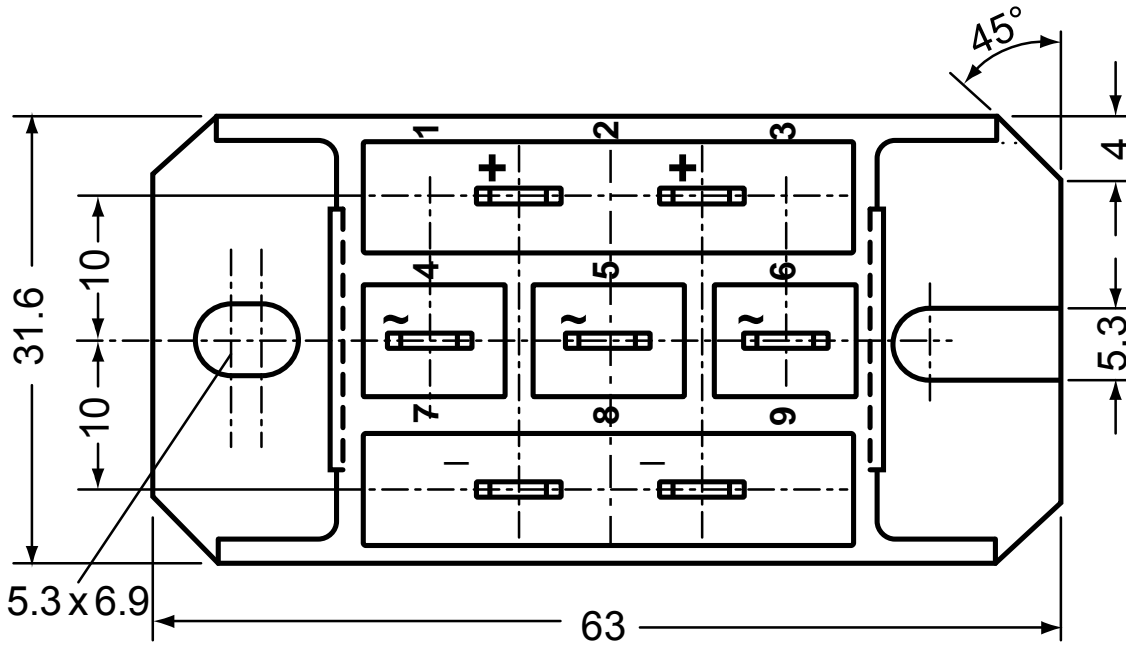
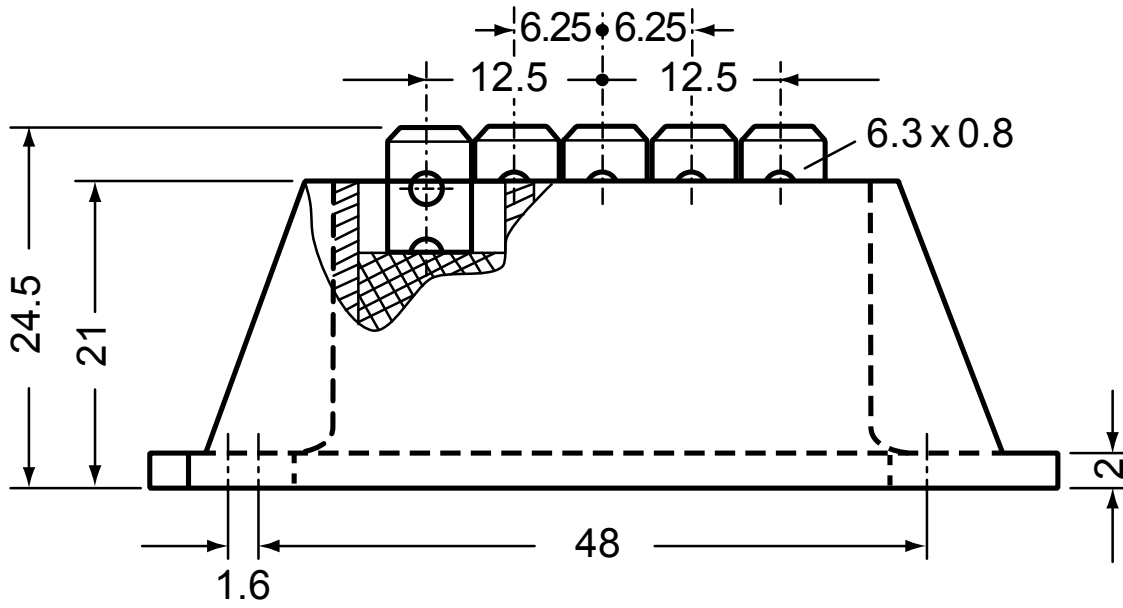

Rectifier

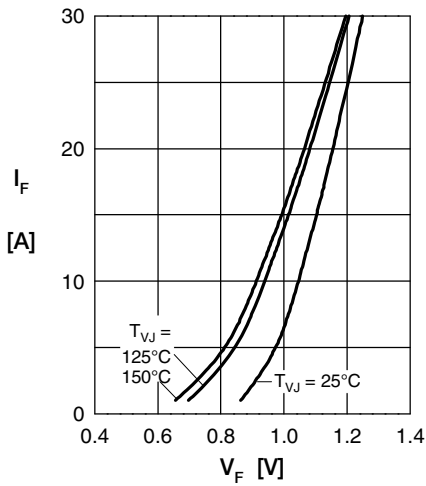

Fig. 1 Forward current vs. voltage drop per diode

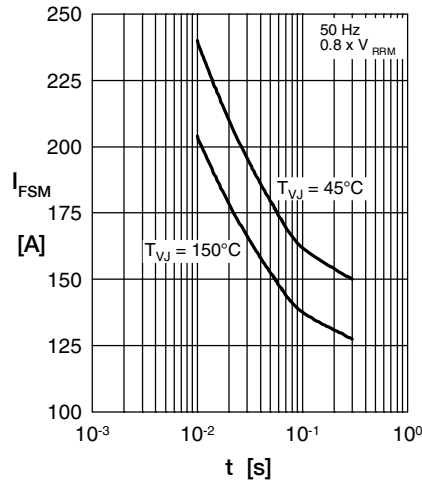

Fig. 2 Surge overload current vs. time per diode

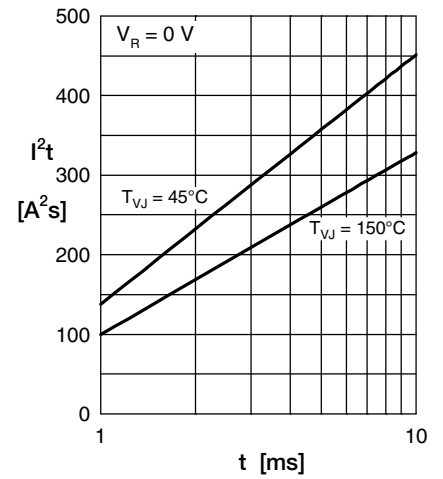

Fig. 3 I^2t vs. time per diode

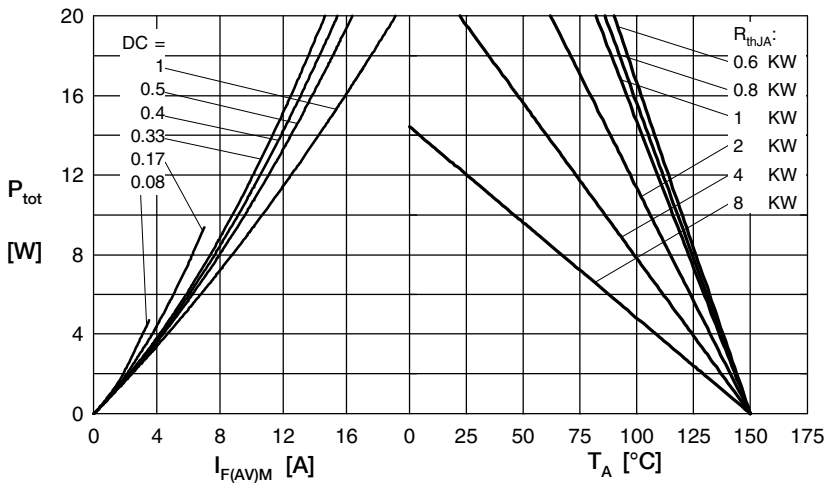

Fig. 4 Power dissipation vs. forward current and ambient temperature per diode

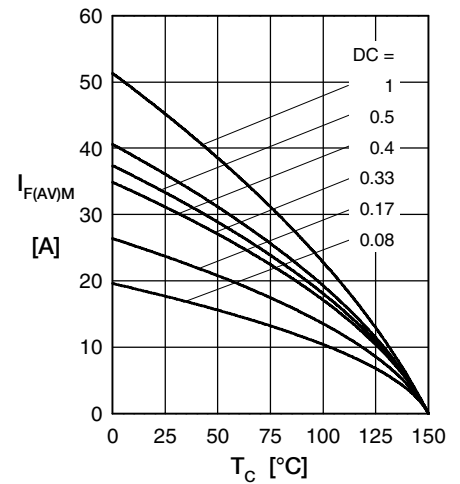

Fig. 5 Max. forward current vs. case temperature per diode

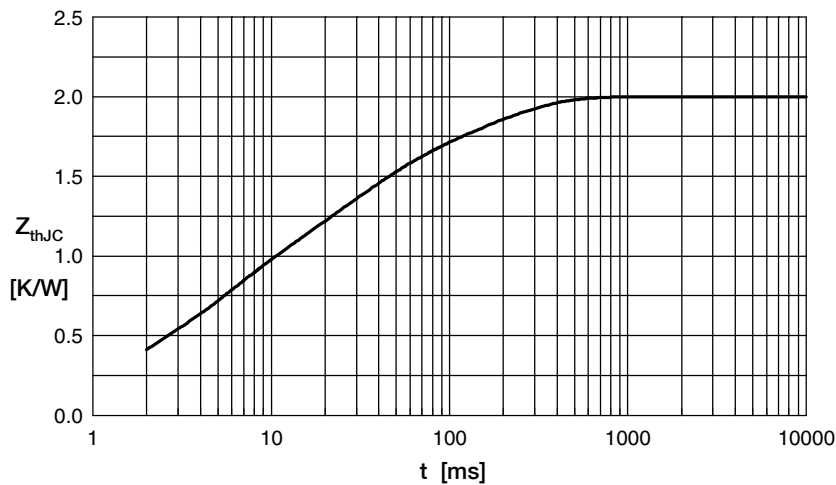

Fig. 6 Transient thermal impedance junction to case vs. time per diode

Constants for Z_{thJC} calculation:

i	R_{th} (K/W)	t_i (s)
1	0.0607	0.00040
2	0.2030	0.00256
3	0.5005	0.00450
4	0.7030	0.02420
5	0.5328	0.15000