

Standard Rectifier Module

3~ Rectifier	
V_{RRM}	= 1800 V
I_{DAV}	= 90 A
I_{FSM}	= 750 A

3~ Rectifier Bridge

Part number

VUO82-18N07



E72873

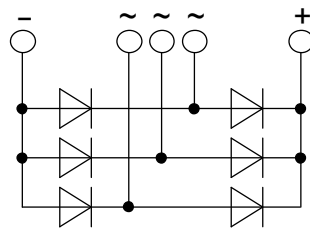

Features / Advantages:

- Package with DCB ceramic
- Improved temperature and power cycling
- Planar passivated chips
- Very low forward voltage drop
- Very low leakage current

Applications:

- Diode for main rectification
- For three phase bridge configurations
- Supplies for DC power equipment
- Input rectifiers for PWM inverter
- Battery DC power supplies
- Field supply for DC motors

Package: PWS-D

- Industry standard outline
- RoHS compliant
- Easy to mount with two screws
- Base plate: Copper internally DCB isolated
- Advanced power cycling

Rectifier				Ratings				
Symbol	Definition	Conditions		min.	typ.	max.	Unit	
V_{RSM}	max. non-repetitive reverse blocking voltage					1900	V	
V_{RRM}	max. repetitive reverse blocking voltage					1800	V	
I_R	reverse current	$V_R = 1800$ V	$T_{VJ} = 25^\circ\text{C}$			100	μA	
		$V_R = 1800$ V	$T_{VJ} = 150^\circ\text{C}$			1.5	mA	
V_F	forward voltage drop	$I_F = 30$ A	$T_{VJ} = 25^\circ\text{C}$			1.08	V	
						1.35	V	
		$I_F = 90$ A	$T_{VJ} = 125^\circ\text{C}$			0.99	V	
						1.33	V	
I_{DAV}	bridge output current	$T_C = 115^\circ\text{C}$ rectangular	$T_{VJ} = 150^\circ\text{C}$			90	A	
								$d = \frac{1}{3}$
V_{FO}	threshold voltage					0.78	V	
r_F	slope resistance							6
R_{thJC}	thermal resistance junction to case					0.9	K/W	
R_{thCH}	thermal resistance case to heatsink				0.4		K/W	
P_{tot}	total power dissipation			$T_C = 25^\circ\text{C}$		135	W	
I_{FSM}	max. forward surge current	$t = 10$ ms; (50 Hz), sine	$T_{VJ} = 45^\circ\text{C}$			750	A	
								$t = 8,3$ ms; (60 Hz), sine
		$t = 10$ ms; (50 Hz), sine	$T_{VJ} = 150^\circ\text{C}$				640	A
I^2t	value for fusing	$t = 10$ ms; (50 Hz), sine	$T_{VJ} = 45^\circ\text{C}$			2.82	kA^2s	
								$t = 8,3$ ms; (60 Hz), sine
		$t = 10$ ms; (50 Hz), sine	$T_{VJ} = 150^\circ\text{C}$				2.05	kA^2s
C_J	junction capacitance	$V_R = 400$ V; $f = 1$ MHz		$T_{VJ} = 25^\circ\text{C}$		27	pF	

Package PWS-D			Ratings			
Symbol	Definition	Conditions	min.	typ.	max.	Unit
I_{RMS}	RMS current	per terminal			150	A
T_{stg}	storage temperature		-40		125	°C
T_{VJ}	virtual junction temperature		-40		150	°C
Weight				159		g
M_D	mounting torque		4.25		5.75	Nm
M_T	terminal torque		4.25		5.75	Nm
$d_{Spp/App}$	creepage distance on surface striking distance through air	terminal to terminal	9.5			mm
$d_{Spb/Appb}$		terminal to backside	26.0			mm
V_{ISOL}	isolation voltage	t = 1 second	3000			V
		t = 1 minute	2500			V

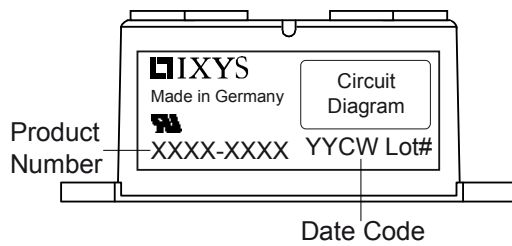

Ordering	Part Number	Marking on Product	Delivery Mode	Quantity	Code No.
Standard	VUO82-18NO7	VUO82-18NO7	Box	10	502555

Equivalent Circuits for Simulation

* on die level

$T_{VJ} = 150\text{ °C}$



Rectifier

$V_{0\ max}$	threshold voltage	0.78	V
$R_{0\ max}$	slope resistance *	4.8	mΩ

Outlines PWS-D

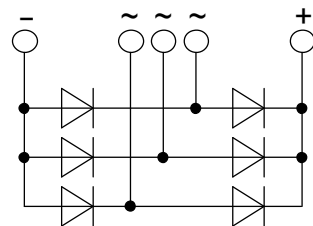
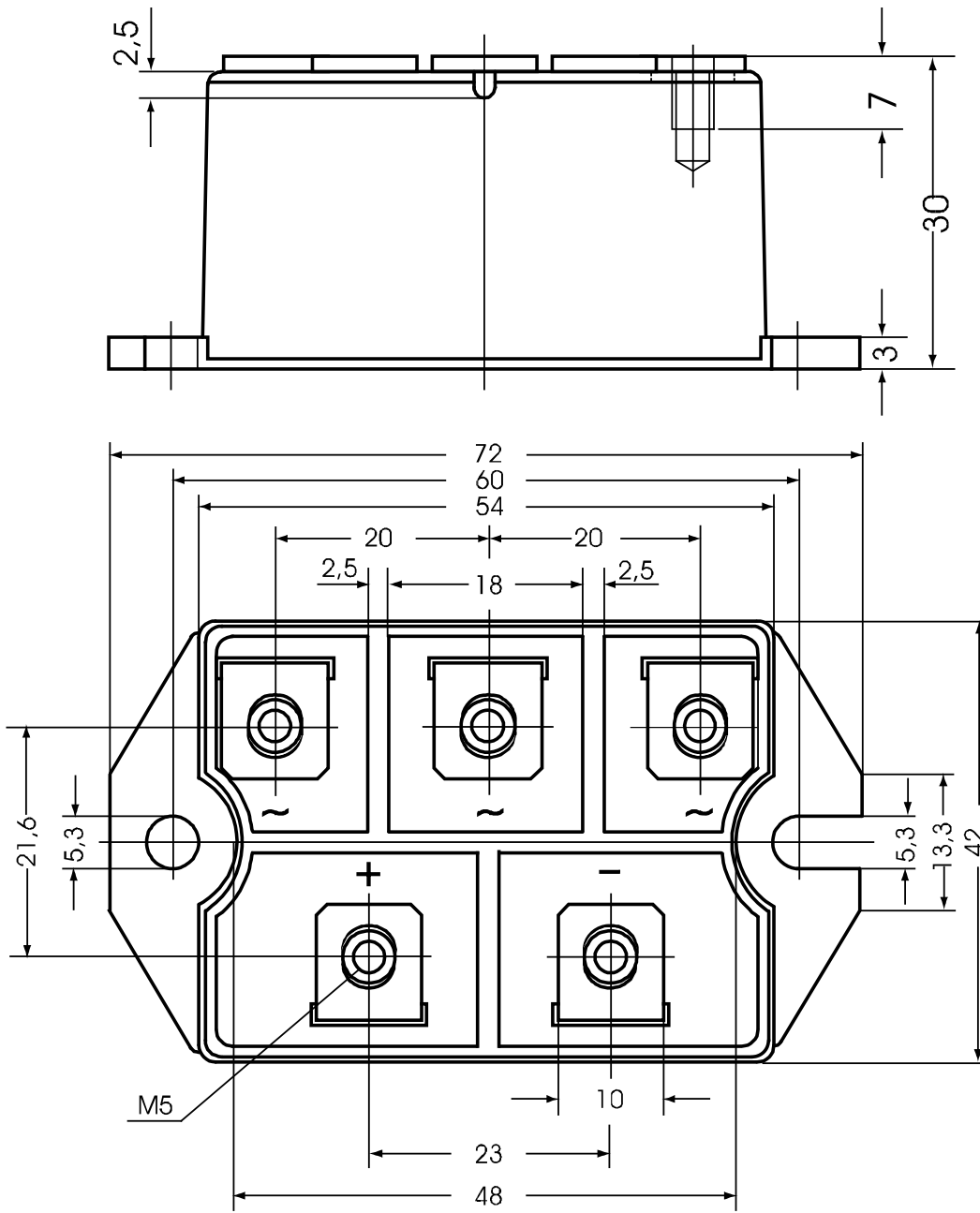

Rectifier

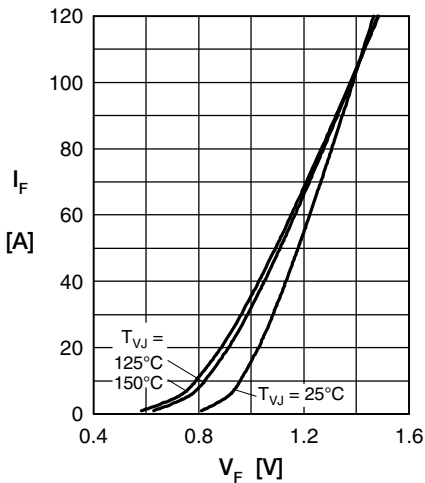

Fig. 1 Forward current versus voltage drop per diode

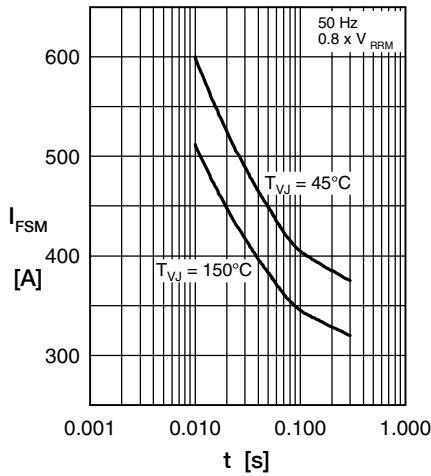

Fig. 2 Surge overload current

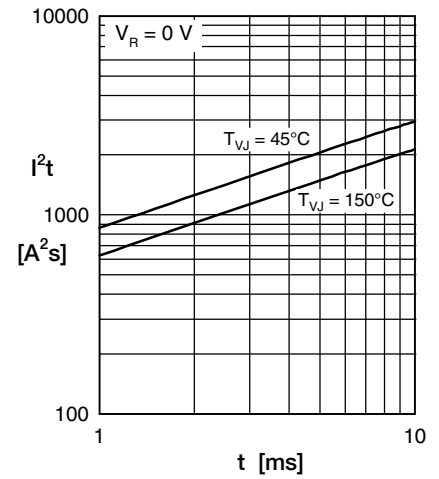

Fig. 3 I^2t versus time per diode

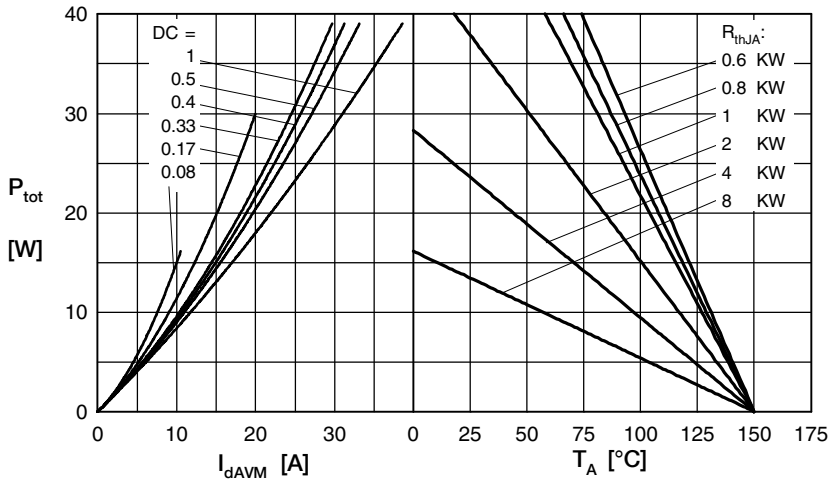

Fig. 4 Power dissipation vs. direct output current & ambient temperature

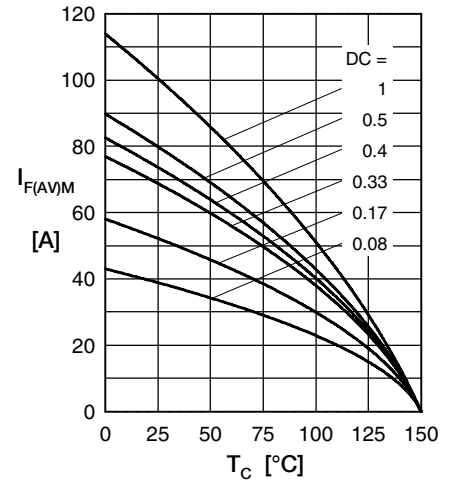

Fig. 5 Max. forward current vs. case temperature

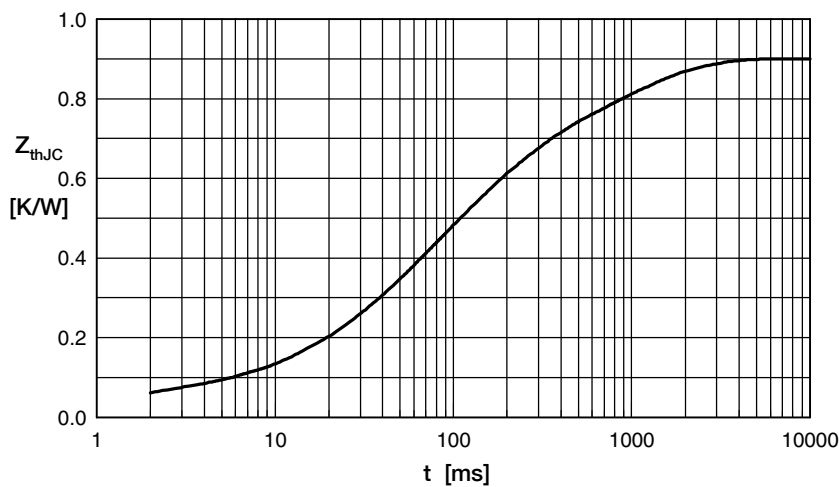

Fig. 6 Transient thermal impedance junction to case

Constants for Z_{thJC} calculation:

i	R_{th} (K/W)	t_i (s)
1	0.05	0.001
2	0.14	0.030
3	0.18	0.070
4	0.28	0.150
5	0.25	0.950