

Standard Rectifier Module

| | |
|-------------------------|-------|
| 3~ Rectifier | |
| V_{RRM} = | 800 V |
| I_{DAV} = | 90 A |
| I_{FSM} = | 550 A |

3~ Rectifier Bridge

Part number

VUO86-08NO7

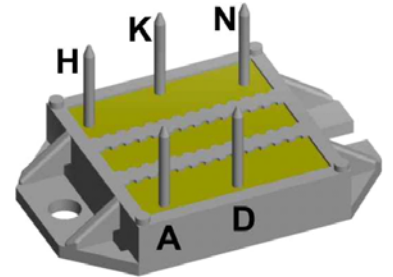

E72873

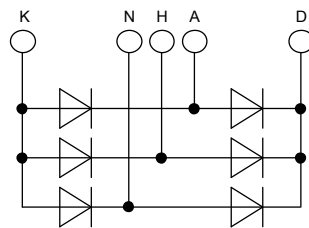

Features / Advantages:

- Package with DCB ceramic
- Improved temperature and power cycling
- Planar passivated chips
- Very low forward voltage drop
- Very low leakage current

Applications:

- Diode for main rectification
- For three phase bridge configurations
- Supplies for DC power equipment
- Input rectifiers for PWM inverter
- Battery DC power supplies
- Field supply for DC motors

Package: ECO-PAC1

- Industry standard outline
- RoHS compliant
- Soldering pins for PCB mounting
- Height: 9 mm
- Base plate: DCB ceramic
- Reduced weight
- Advanced power cycling

| Rectifier | | | | Ratings | | |
|------------|--|--|--------------------------------|---------|------|-------------------|
| Symbol | Definition | Conditions | min. | typ. | max. | Unit |
| V_{RSM} | max. non-repetitive reverse blocking voltage | $T_{VJ} = 25^{\circ}\text{C}$ | | | 900 | V |
| V_{RRM} | max. repetitive reverse blocking voltage | $T_{VJ} = 25^{\circ}\text{C}$ | | | 800 | V |
| I_R | reverse current | $V_R = 800\text{ V}$ | $T_{VJ} = 25^{\circ}\text{C}$ | | 40 | μA |
| | | $V_R = 800\text{ V}$ | $T_{VJ} = 150^{\circ}\text{C}$ | | 1.5 | mA |
| V_F | forward voltage drop | $I_F = 30\text{ A}$ | $T_{VJ} = 25^{\circ}\text{C}$ | | 1.14 | V |
| | | $I_F = 90\text{ A}$ | | | 1.48 | V |
| | | $I_F = 30\text{ A}$ | $T_{VJ} = 125^{\circ}\text{C}$ | | 1.06 | V |
| | | $I_F = 90\text{ A}$ | | | 1.51 | V |
| I_{DAV} | bridge output current | $T_C = 105^{\circ}\text{C}$ rectangular $d = \frac{1}{3}$ | $T_{VJ} = 150^{\circ}\text{C}$ | | 90 | A |
| V_{FO} | threshold voltage | } for power loss calculation only | $T_{VJ} = 150^{\circ}\text{C}$ | | 0.81 | V |
| r_F | slope resistance | | | | 7.8 | m Ω |
| R_{thJC} | thermal resistance junction to case | | | | 0.9 | K/W |
| R_{thCH} | thermal resistance case to heatsink | | | 0.4 | | K/W |
| P_{tot} | total power dissipation | | $T_C = 25^{\circ}\text{C}$ | | 135 | W |
| I_{FSM} | max. forward surge current | $t = 10\text{ ms}; (50\text{ Hz}), \text{ sine}$ | $T_{VJ} = 45^{\circ}\text{C}$ | | 550 | A |
| | | $t = 8,3\text{ ms}; (60\text{ Hz}), \text{ sine}$ | $V_R = 0\text{ V}$ | | 595 | A |
| | | $t = 10\text{ ms}; (50\text{ Hz}), \text{ sine}$ | $T_{VJ} = 150^{\circ}\text{C}$ | | 470 | A |
| | | $t = 8,3\text{ ms}; (60\text{ Hz}), \text{ sine}$ | $V_R = 0\text{ V}$ | | 505 | A |
| I^2t | value for fusing | $t = 10\text{ ms}; (50\text{ Hz}), \text{ sine}$ | $T_{VJ} = 45^{\circ}\text{C}$ | | 1.52 | kA ² s |
| | | $t = 8,3\text{ ms}; (60\text{ Hz}), \text{ sine}$ | $V_R = 0\text{ V}$ | | 1.48 | kA ² s |
| | | $t = 10\text{ ms}; (50\text{ Hz}), \text{ sine}$ | $T_{VJ} = 150^{\circ}\text{C}$ | | 1.11 | kA ² s |
| | | $t = 8,3\text{ ms}; (60\text{ Hz}), \text{ sine}$ | $V_R = 0\text{ V}$ | | 1.06 | kA ² s |
| C_J | junction capacitance | $V_R = 400\text{ V}; f = 1\text{ MHz}$ | $T_{VJ} = 25^{\circ}\text{C}$ | | 18 | pF |

| Package ECO-PAC1 | | | Ratings | | | |
|------------------|--|----------------------|---------|------|------|------|
| Symbol | Definition | Conditions | min. | typ. | max. | Unit |
| I_{RMS} | RMS current | per terminal | | | 100 | A |
| T_{stg} | storage temperature | | -40 | | 125 | °C |
| T_{VJ} | virtual junction temperature | | -40 | | 150 | °C |
| Weight | | | | 19 | | g |
| M_D | mounting torque | | 1.5 | | 2 | Nm |
| $d_{Spp/App}$ | creepage distance on surface striking distance through air | terminal to terminal | 6.0 | | | mm |
| $d_{Spb/Apb}$ | | terminal to backside | 10.0 | | | mm |
| V_{ISOL} | isolation voltage | t = 1 second | 3000 | | | V |
| | | t = 1 minute | 2500 | | | V |

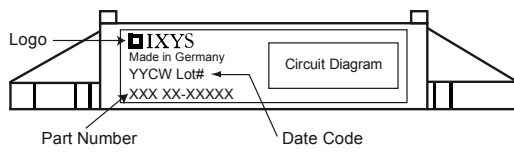

| Ordering | Part Number | Marking on Product | Delivery Mode | Quantity | Code No. |
|----------|-------------|--------------------|---------------|----------|----------|
| Standard | VUO86-08NO7 | VUO86-08NO7 | Box | 25 | 482854 |

Equivalent Circuits for Simulation

* on die level

$T_{VJ} = 150\text{ °C}$



Rectifier

| | | | |
|--------------|--------------------|------|----|
| $V_{0\ max}$ | threshold voltage | 0.81 | V |
| $R_{0\ max}$ | slope resistance * | 6.6 | mΩ |

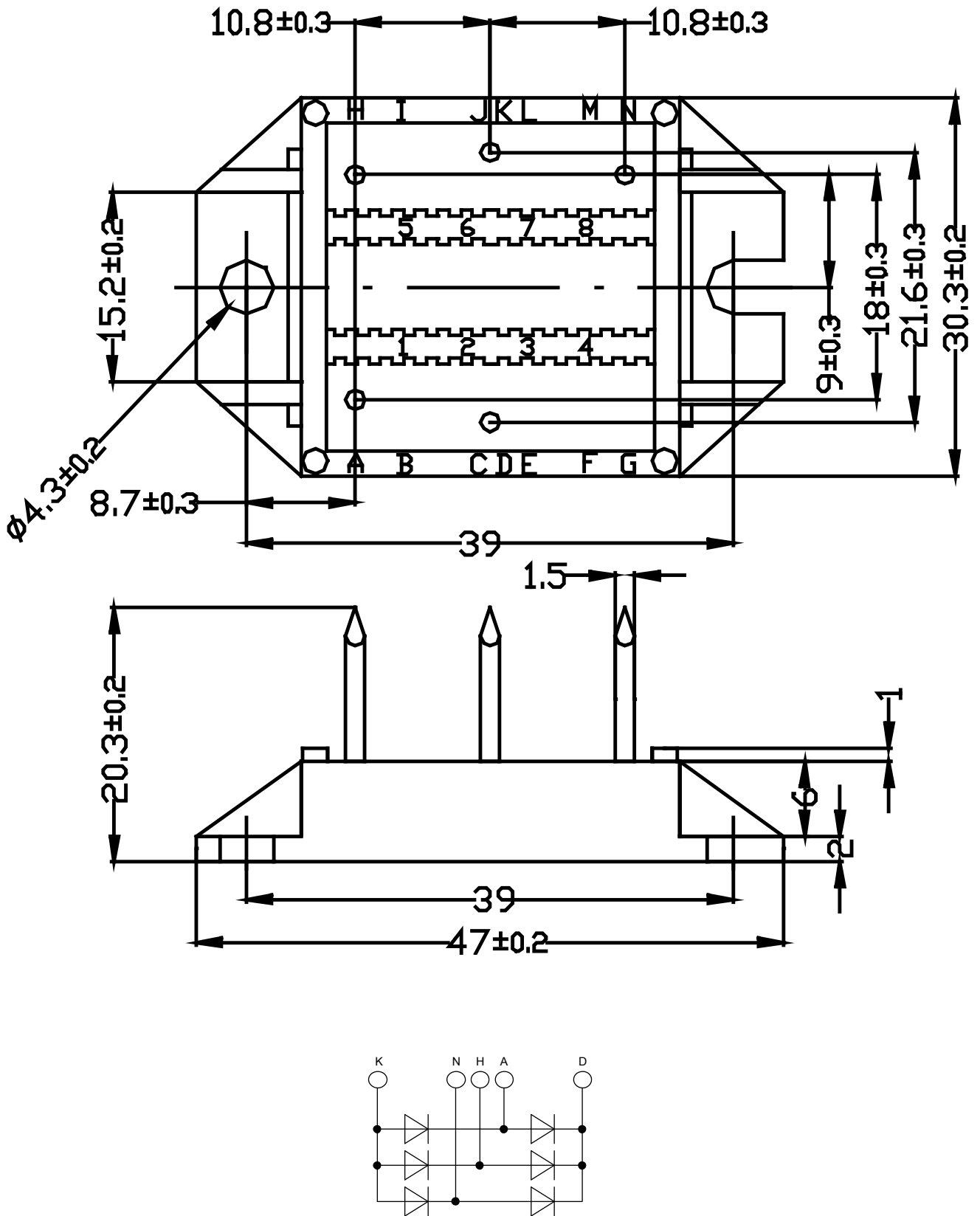

Rectifier

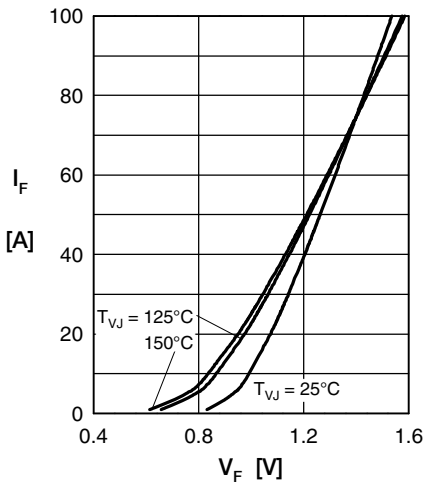

Fig. 1 Forward current versus voltage drop per diode

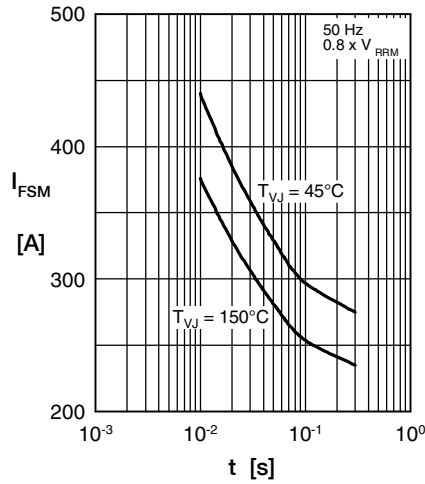

Fig. 2 Surge overload current

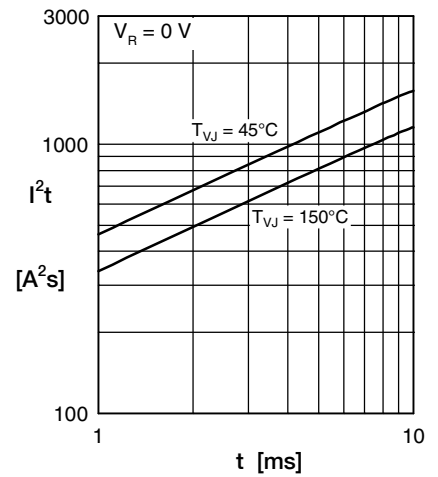

Fig. 3 I^2t versus time per diode

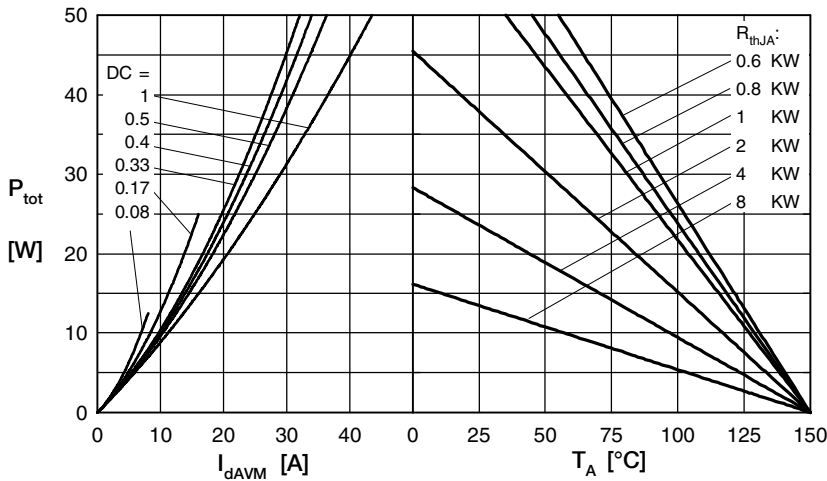

Fig. 4 Power dissipation vs. direct output current & ambient temperature

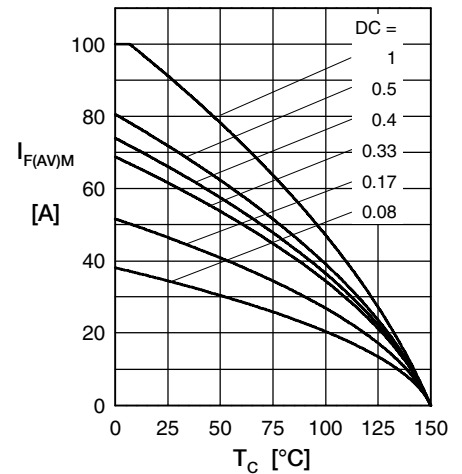

Fig. 5 Max. forward current vs. case temperature

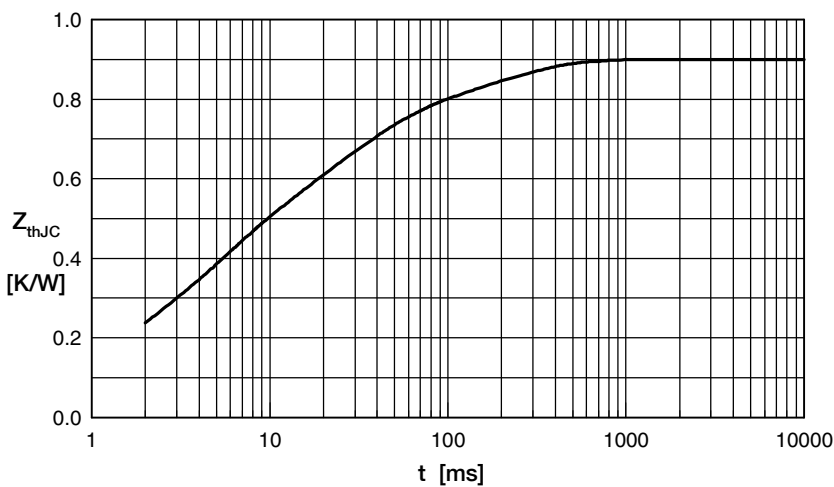

Fig. 6 Transient thermal impedance junction to case

Constants for Z_{thJC} calculation:

| i | R_{th} (K/W) | t_i (s) |
|---|----------------|-----------|
| 1 | 0.0607 | 0.000 |
| 2 | 0.1230 | 0.00256 |
| 3 | 0.2330 | 0.0045 |
| 4 | 0.3230 | 0.0242 |
| 5 | 0.1628 | 0.18 |