

**Table of Contents-**

1.	GENERAL DESCRIPTION	5
2.	FEATURES	5
3.	ORDER INFORMATION	5
4.	BALL ASSIGNMENT	6
5.	BALL CONFIGURATION	7
5.1	Ball description.....	7
5.2	Addressing Table	8
6.	BLOCK DIAGRAM	9
7.	FUNCTIONAL DESCRIPTION.....	10
7.1	Simplified LPDDR3 State Diagram	10
7.1.1	Simplified Bus Interface State Diagram	11
7.2	Power-up, Initialization, and Power-Off	12
7.2.1	Voltage Ramp and Device Initialization.....	12
7.2.2	Initialization after Reset (without Power ramp)	14
7.2.3	Power-off Sequence	14
7.2.4	Uncontrolled Power-Off Sequence	14
7.3	Mode Register Definition.....	15
7.3.1	Mode Register Assignment and Definition	15
7.3.1.1	Mode Register Assignment	15
7.3.2	MR0_Device Information (MA[7:0] = 00H)	16
7.3.3	MR1_Device Feature 1 (MA[7:0] = 01H)	16
7.3.3.1	Burst Sequence	17
7.3.4	MR2_Device Feature 2 (MA[7:0] = 02H)	17
7.3.5	MR3_I/O Configuration 1 (MA[7:0] = 03H)	18
7.3.6	MR4_Device Temperature (MA[7:0] = 04H)	18
7.3.7	MR5_Basic Configuration 1 (MA[7:0] = 05H)	18
7.3.8	MR6_Basic Configuration 2 (MA[7:0] = 06H)	19
7.3.9	MR7_Basic Configuration 3 (MA[7:0] = 07H)	19
7.3.10	MR8_Basic Configuration 4 (MA[7:0] = 08H)	19
7.3.11	MR9_(Reserved) (MA[7:0] = 09H)	19
7.3.12	MR10_Calibration (MA[7:0] = 0AH)	19
7.3.13	MR11_ODT Control (MA[7:0] = 0BH)	20
7.3.14	MR12:15_(Reserved) (MA[7:0] = 0CH-0FH)	20
7.3.15	MR16_PASR_Bank Mask (MA[7:0] = 10H).....	20
7.3.16	MR17_PASR_Segment Mask (MA[7:0] = 11H).....	20
7.3.17	MR18:31_(Reserved) (MA[7:0] = 12H-1FH)	21
7.3.18	MR32_DQ Calibration Pattern A (MA[7:0] = 20H)	21
7.3.19	MR33:39_(Do Not Use) (MA[7:0] = 21H-27H).....	21
7.3.20	MR40_DQ Calibration Pattern B (MA[7:0] = 28H).....	21
7.3.21	MR41_CA Training_1 (MA[7:0] = 29H)	21
7.3.22	MR42_CA Training_2 (MA[7:0] = 2AH)	21
7.3.23	MR43:47_(Do Not Use) (MA[7:0] = 2BH-2FH).....	21
7.3.24	MR48_CA Training_3 (MA[7:0] = 30H)	21
7.3.25	MR49:62_(Reserved) (MA[7:0] = 31H-3EH)	21
7.3.26	MR63_Reset (MA[7:0] = 3FH)	21
7.3.27	MR64:255_(Reserved) (MA[7:0] = 40H-FFH)	21
7.4	Command Definitions and Timing Diagrams.....	22
7.4.1	Activate Command	22
7.4.1.1	8-Bank Device Operation	22
7.4.2	Command Input Signal Timing Definition	23
7.4.2.1	CKE Input Setup and Hold Timing	24
7.4.3	Read and Write Access Modes.....	24
7.4.4	Burst Read Operation.....	24



7.4.5	Burst Write Operation	29
7.4.5.1	t_{WPRE} Calculation	30
7.4.5.2	t_{WPST} Calculation.....	30
7.4.6	Write Data Mask.....	32
7.4.7	Precharge Operation	33
7.4.7.1	Burst Read Operation Followed by Precharge	33
7.4.7.2	Burst Write Followed by Precharge	34
7.4.8	Auto Precharge Operation	34
7.4.8.1	Burst Read with Auto-Precharge.....	35
7.4.8.2	Burst Write with Auto-Precharge	35
7.4.8.3	Precharge & Auto Precharge Clarification	36
7.4.9	Refresh command	37
7.4.9.1	Refresh Command Scheduling Separation Requirements.....	38
7.4.9.2	Refresh Requirements	40
7.4.10	Self Refresh Operation	41
7.4.11	Partial Array Self-Refresh (PASR)	43
7.4.11.1	PASR Bank Masking.....	43
7.4.11.2	PASR Segment Masking.....	43
7.4.12	Mode Register Read (MRR) Command	44
7.4.12.1	Temperature Sensor	47
7.4.12.2	DQ Calibration	48
7.4.13	Mode Register Write (MRW) Command	49
7.4.13.1	Mode Register Write	50
7.4.13.1.1	MRW RESET	50
7.4.13.2	Mode Register Write ZQ Calibration Command	51
7.4.13.2.1	ZQ External Resistor Value, Tolerance, and Capacitive Loading	53
7.4.13.3	Mode Register Write – CA Training Mode	53
7.4.13.3.1	CA Training Sequence.....	53
7.4.13.4	Mode Register Write – WR Leveling Mode.....	55
7.4.14	On-Die Termination	56
7.4.14.1	ODT Mode register	56
7.4.14.2	Asynchronous ODT.....	56
7.4.14.3	ODT During Read Operations (RD or MRR).....	57
7.4.14.4	ODT During Power Down.....	57
7.4.14.5	ODT During Self Refresh	57
7.4.14.6	ODT During Deep Power Down	57
7.4.14.7	ODT During CA Training and Write Leveling	57
7.4.15	Power-Down.....	59
7.4.16	Deep Power-Down	64
7.4.17	Input clock stop and frequency change.....	65
7.4.18	No Operation Command.....	66
7.5	Truth Tables.....	67
7.5.1	Command Truth Table.....	67
7.5.2	CKE Truth Table.....	68
7.5.3	State Truth Tables.....	69
7.5.4	Data Mask Truth Table	72
8.	ELECTRICAL CHARACTERISTIC	73
8.1	Absolute Maximum DC Ratings	73
8.2	AC & DC Operating Conditions.....	73
8.2.1	Recommended DC Operating Conditions	73
8.2.1.1	Recommended DC Operating Conditions	73
8.2.2	Input Leakage Current.....	74
8.2.3	Operating Temperature Range.....	74
8.2.4	AC and DC Input Measurement Levels.....	74
8.2.4.1	AC and DC Logic Input Levels for Single-Ended Signals.....	74
8.2.4.1.1	Single-Ended AC and DC Input Levels for CA and CS_n Inputs	74
8.2.4.1.2	Single-Ended AC and DC Input Levels for CKE	75



8.2.4.1.3	Single-Ended AC and DC Input Levels for DQ and DM	75
8.2.4.2	VREF Tolerances	75
8.2.4.3	Input Signal.....	77
8.2.4.4	AC and DC Logic Input Levels for Differential Signals.....	78
8.2.4.4.1	Differential Signal Definition	78
8.2.4.4.2	Differential swing requirements for clock (CK_t - CK_c) and strobe (DQS_t - DQS_c)	78
8.2.4.5	Single-ended requirements for differential signals	79
8.2.4.6	Differential Input Cross Point Voltage.....	80
8.2.4.7	Slew Rate Definitions for Single-Ended Input Signals	81
8.2.4.8	Slew Rate Definitions for Differential Input Signals.....	81
8.2.5	AC and DC Output Measurement Levels.....	82
8.2.5.1	Single Ended AC and DC Output Levels.....	82
8.2.5.2	Differential AC and DC Output Levels	82
8.2.5.3	Single Ended Output Slew Rate.....	82
8.2.5.4	Differential Output Slew Rate.....	84
8.2.5.5	Overshoot and Undershoot Specifications	85
8.2.6	Output buffer characteristics.....	86
8.2.6.1	HSUL_12 Driver Output Timing Reference Load.....	86
8.2.6.2	R _{ONPU} and R _{ONPD} Resistor Definition	86
8.2.6.3	R _{ONPU} and R _{ONPD} Characteristics with ZQ Calibration.....	87
8.2.6.4	Output Driver Temperature and Voltage Sensitivity.....	87
8.2.6.5	R _{ONPU} and R _{ONPD} Characteristics without ZQ Calibration.....	88
8.2.6.6	R _{ZQ} I-V Curve.....	89
8.2.6.7	ODT Levels and I-V Characteristics	91
8.3	Input/Output Capacitance	92
8.4	IDD Specification Parameters and Test Conditions	93
8.4.1	IDD Measurement Conditions.....	93
8.4.2	IDD Specifications	95
8.4.2.1	IDD Specification Parameters and Operating Conditions (85°C, x16, x32)	95
8.4.2.2	IDD6 Partial Array Self-Refresh Current (x16, x32)	98
8.5	Clock Specification.....	98
8.5.1	Definition for tCK(avg) and nCK.....	98
8.5.2	Definition for tCK(abs)	98
8.5.3	Definition for tCH(avg) and tCL(avg).....	99
8.5.4	Definition for tJIT(per).....	99
8.5.5	Definition for tJIT(cc)	99
8.5.6	Definition for tERR(nper)	99
8.5.7	Definition for Duty Cycle Jitter tJIT(duty).....	100
8.5.8	Definition for tCK(abs), tCH(abs) and tCL(abs).....	100
8.6	Period Clock Jitter.....	100
8.6.1	Clock period jitter effects on core timing parameters.....	100
8.6.1.1	Cycle time de-rating for core timing parameters.....	100
8.6.1.2	Clock cycle de-rating for core timing parameters.....	101
8.6.2	Clock jitter effects on Command/Address timing parameters	101
8.6.3	Clock jitter effects on Read timing parameters.....	101
8.6.3.1	tRPRE	101
8.6.3.2	tLZ(DQ), tHZ(DQ), tDQSCK, tLZ(DQS), tHZ(DQS)	101
8.6.3.3	tQSH, tQSL.....	101
8.6.3.4	tRPST.....	102
8.6.4	Clock jitter effects on Write timing parameters	102
8.6.4.1	tDS, tDH	102
8.6.4.2	tDSS, tDSH.....	102
8.6.4.3	tDQSS	102
8.7	Refresh Requirements	103
8.7.1	Refresh Requirement Parameters	103
8.7.2	LPDDR3 Read and Write Latencies.....	103
8.8	AC Timings	104



8.8.1	LPDDR3 AC Timing	104
8.8.2	CA and CS_n Setup, Hold and Derating	109
8.8.3	Data Setup, Hold and Slew Rate Derating	115
9.	PACKAGE DIMENSIONS	121
10.	REVISION HISTORY	122



1. GENERAL DESCRIPTION

This LPDDR3 is a high-speed SDRAM device internally configured as an 8-Bank memory and contains 1,073,741,824 bits.

This LPDDR3 device uses a double data rate architecture on the Command/Address (CA) bus to reduce the number of input pins in the system. The 10-bit CA bus contains command, address, and Bank/Row Buffer information. Each command uses one clock cycle, during which command information is transferred on both the positive and negative edge of the clock.

2. FEATURES

- | | |
|---|--|
| • VDD1 = 1.7~1.95V | • Deep Power Down Mode (DPD Mode) |
| • VDD2/VDDCA/ VDDQ = 1.14V~1.30V | • Double data rate architecture |
| • Data width: x16 / x32 | • Clock Stop capability |
| • Clock rate: up to 1066 MHz | • Programmable Read and Write Latencies (RL/WL) |
| • Data rate: up to 2133 Mbps | • Bidirectional differential data strobe |
| • 8 internal banks for concurrent operation | • Support Boundary Scan for connectivity test* |
| • 8n pre-fetch operation | • Support package:
VFBGA178 (11mm x11.5mm) |
| • Burst length: 8 | • Operating Temperature Range:
-25°C ≤ TCASE ≤ 85°C
-40°C ≤ TCASE ≤ 85°C |
| • Per Bank Refresh | |
| • Partial Array Self-Refresh(PASR) | |
| • On-die termination (ODT) | |

* For further information about Boundary Scan for connectivity test, please contact sales representative.

3. ORDER INFORMATION

Part Number	VDD1/VDD2/VDDQ	I/O Width	Type	Others
W63AH6NBVABE	1.8V/1.2V/1.2V	16	VFBGA178	LPDDR3-1600, -25°C~85°C
W63AH6NBVACE	1.8V/1.2V/1.2V	16	VFBGA178	LPDDR3-1866, -25°C~85°C
W63AH6NBVADE	1.8V/1.2V/1.2V	16	VFBGA178	LPDDR3-2133, -25°C~85°C
W63AH6NBVABI	1.8V/1.2V/1.2V	16	VFBGA178	LPDDR3-1600, -40°C~85°C
W63AH6NBVACI	1.8V/1.2V/1.2V	16	VFBGA178	LPDDR3-1866, -40°C~85°C
W63AH6NBVADI	1.8V/1.2V/1.2V	16	VFBGA178	LPDDR3-2133, -40°C~85°C
W63AH2NBVABE	1.8V/1.2V/1.2V	32	VFBGA178	LPDDR3-1600, -25°C~85°C
W63AH2NBVACE	1.8V/1.2V/1.2V	32	VFBGA178	LPDDR3-1866, -25°C~85°C
W63AH2NBVADE	1.8V/1.2V/1.2V	32	VFBGA178	LPDDR3-2133, -25°C~85°C
W63AH2NBVABI	1.8V/1.2V/1.2V	32	VFBGA178	LPDDR3-1600, -40°C~85°C
W63AH2NBVACI	1.8V/1.2V/1.2V	32	VFBGA178	LPDDR3-1866, -40°C~85°C
W63AH2NBVADI	1.8V/1.2V/1.2V	32	VFBGA178	LPDDR3-2133, -40°C~85°C



4. BALL ASSIGNMENT

[Top View]

	1	2	3	4	5	6	7	8	9	10	11	12	13	
A	DNU	DNU	VDD1	VDD1	VDD1	VDD1		VDD2	VDD2	VDD1	VDDQ	DNU	DNU	A
B	DNU	VSS	ZQ	NC	VSS	VSS		DQ31 NC	DQ30 NC	DQ29 NC	DQ28 NC	VSS	DNU	B
C		CA9	VSS	NC	VSS	VSS		DQ27 NC	DQ26 NC	DQ25 NC	DQ24 NC	VDDQ		C
D		CA8	VSS	VDD2	VDD2	VDD2		DM3 NC	DQ15	DQS3_t NC	DQS3_c NC	VSS		D
E		CA7	CA6	VSS	VSS	VSS		VDDQ	DQ14	DQ13	DQ12	VDDQ		E
F		VDDCA	CA5	VSS	VSS	VSS		DQ11	DQ10	DQ9	DQ8	VSS		F
G		VDDCA	VSS	VSS	VDD2	VSS		DM1	VSS	DQS1_t	DQS1_c	VDDQ		G
H		VSS	VDDCA	VREF(CA)	VDD2	VDD2		VDDQ	VDDQ	VSS	VDDQ	VDD2		H
J		CK_c	CK_t	VSS	VDD2	VDD2		ODT	VDDQ	VDDQ	VREF(DQ)	VSS		J
K		VSS	CKE	NC	VDD2	VDD2		VDDQ	NC	VSS	VDDQ	VDD2		K
L		VDDCA	CS_n	NC	VDD2	VSS		DM0	VSS	DQS0_t	DQS0_c	VDDQ		L
M		VDDCA	CA4	VSS	VSS	VSS		DQ4	DQ5	DQ6	DQ7	VSS		M
N		CA2	CA3	VSS	VSS	VSS		VDDQ	DQ1	DQ2	DQ3	VDDQ		N
P		CA1	VSS	VDD2	VDD2	VDD2		DM2 NC	DQ0	DQS2_t NC	DQS2_c NC	VSS		P
R		CA0	SEN	VSS	VSS	VSS		DQ20 NC	DQ21 NC	DQ22 NC	DQ23 NC	VDDQ		R
T	DNU	VSS	VSS	VSS	VSS	VSS		DQ16 NC	DQ17 NC	DQ18 NC	DQ19 NC	VSS	DNU	T
U	DNU	DNU	VDD1	VDD1	VDD1	VDD1		VDD2	VDD2	VDD1	VDDQ	DNU	DNU	U

Ball Definition where 2 labels are present	
1st Row	x32 device
2nd Row	x16 device

	Boundary Scan Enable
	Power
	Ground
	DQ/DQS DM
	CA/CS_n CKE
	Clock
	ODT
	ZQ
	Do Not Use NC

VFBGA178 Ball Assignments



5. BALL CONFIGURATION

5.1 Ball description

Name	Type	Description
CK_t, CK_c	Input	Clock: CK_t and CK_c are differential clock inputs. All Double Data Rate (DDR) CA inputs are sampled on both positive and negative edge of CK_t. Single Data Rate (SDR) inputs, CS_n and CKE, are sampled at the positive Clock edge. Clock is defined as the differential pair, CK_t and CK_c. The positive Clock edge is defined by the crosspoint of a rising CK_t and a falling CK_c. The negative Clock edge is defined by the crosspoint of a falling CK_t and a rising CK_c.
CKE	Input	Clock Enable: CKE HIGH activates and CKE LOW deactivates internal clock signals and therefore device input buffers and output drivers. Power savings modes are entered and exited through CKE transitions. CKE is considered part of the command code. See 7.5.1 “ Command Truth Table ” for command code descriptions. CKE is sampled at the positive Clock edge.
CS_n	Input	Chip Select: CS_n is considered part of the command code. See 7.5.1 “ Command Truth Table ” for command code descriptions. CS_n is sampled at the positive Clock edge.
CA[9:0]	Input	DDR Command/Address Inputs: Uni-directional command/address bus inputs. CA is considered part of the command code. See 7.5.1 “ Command Truth Table ” for command code descriptions.
DQ[n:0]	I/O	Data Inputs/Output: Bi-directional data bus. DQ[15:0] for x16, DQ[31:0] for x32.
DQSn_t, DQSn_c	I/O	Data Strobe (Bi-directional, Differential): The data strobe is bi-directional (used for read and write data) and differential (DQS_t and DQS_c). It is output with read data and input with write data. DQS_t is edge-aligned to read data and centered with write data. For x16, DQS0_t and DQS0_c correspond to the data on DQ0-7; DQS1_t and DQS1_c to the data on DQ8-15. For x32 DQS0_t and DQS0_c correspond to the data on DQ0-7; DQS1_t and DQS1_c to the data on DQ8-15; DQS2_t and DQS2_c to the data on DQ16-23; DQS3_t and DQS3_c to the data on DQ24-31.
DMn	Input	Input Data Mask: DM is the input mask signal for write data. Input data is masked when DM is sampled HIGH coincident with that input data during a Write access. DM is sampled on both edges of DQS_t. Although DM is for input only, the DM loading shall match the DQ and DQS (or DQS_c). For x16 and x32 devices, DM0 is the input data mask signal for the data on DQ0-7. DM1 is the input data mask signal for the data on DQ8-15. For x32 devices, DM2 is the input data mask signal for the data on DQ16-23 and DM3 is the input data mask signal for the data on DQ24-31.
ODT	Input	On-Die Termination: This signal enables and disables termination on the DRAM DQ bus according to the specified mode register settings.
VDD1	Supply	Core Power Supply 1: Core Power supply.
VDD2	Supply	Core Power Supply 2: Core Power supply.
VDDCA	Supply	Input Receiver Power Supply: Power supply for CA[9:0], CKE, CS_n, CK_t, and CK_c input buffers.
VDDQ	Supply	I/O Power Supply: Power supply for Data input/output buffers.
VREF(CA)	Supply	Reference Voltage for CA Command and Control Input Receiver: Reference voltage for all CA[9:0], CKE, CS_n, CK_t, and CK_c input buffers.
VREF(DQ)	Supply	Reference Voltage for DQ Input Receiver: Reference voltage for all Data input buffers.
VSS	Supply	Ground: Ground of core logic, input receivers and data input/output buffers.
ZQ	I/O	Reference Pin for Output Drive Strength Calibration
SEN	Input	Scan Enable: SEN must be asserted HIGH for enabling boundary scan function. Must be tied to Ground or NC (No Connection) when not in use.
NC	--	No Connection
DNU	--	Do Not Use

Note: Data includes DQ and DM.



5.2 Addressing Table

Density		1Gb
Number of Banks		8
Bank Addresses		BA0-BA2
x16	Row Addresses	R0-R12
	Column Addresses* ¹	C0-C9
x32	Row Addresses	R0-R12
	Column Addresses* ¹	C0-C8

Notes:

1. The least-significant column address C0 is not transmitted on the CA bus, and is implied to be zero.
2. Row and Column Address values on the CA bus that are not used are "don't care".



6. BLOCK DIAGRAM

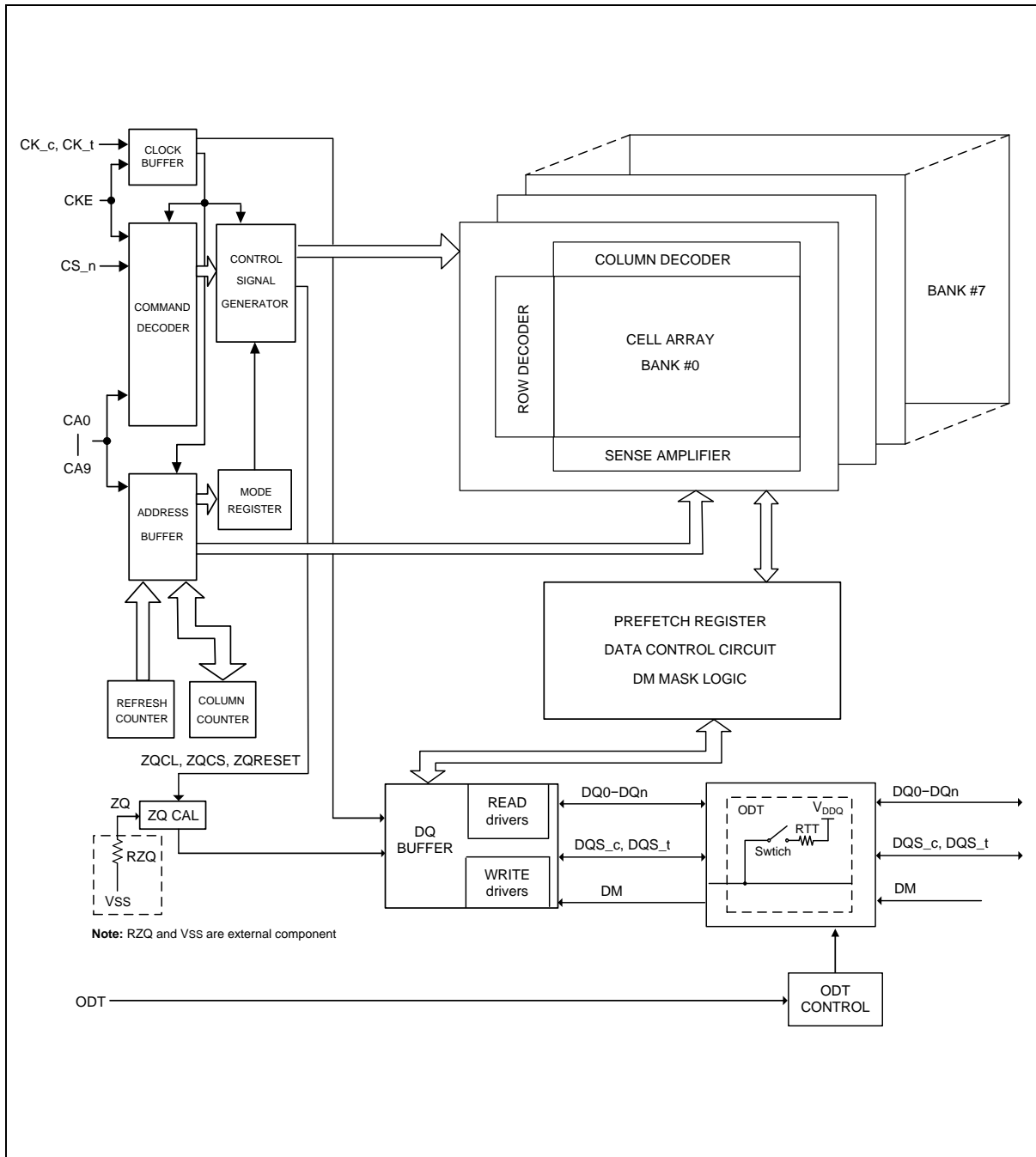



7. FUNCTIONAL DESCRIPTION

For this LPDDR3 device, accesses begin with the registration of an Activate command, which is then followed by a Read or Write command. The address and BA bits registered coincident with the Activate command are used to select the row and the Bank to be accessed. The address bits registered coincident with the Read or Write command are used to select the Bank and the starting column location for the burst access.

This device also uses double data rate architecture on the DQ pins to achieve high speed operation. The double data rate architecture is essentially an $8n$ prefetch architecture with an interface designed to transfer two data bits per DQ every clock cycle at the I/O pins. A single read or write access for the LPDDR3 SDRAM effectively consists of a single $8n$ -bit wide, one clock cycle data transfer at the internal DRAM core and eight corresponding n -bit wide, one-half-clock-cycle data transfers at the I/O pins.

Read and write accesses to this LPDDR3 SDRAMs are burst oriented; accesses start at a selected location and continue for a programmed number of locations in a programmed sequence. Prior to normal operation, this LPDDR3 SDRAM must be initialized. The following section provides detailed information covering device initialization, register definition, command description and device operation.

7.1 Simplified LPDDR3 State Diagram

LPDDR3-SDRAM state diagram provides a simplified illustration of allowed state transitions and the related commands to control them. For a complete definition of the device behavior, the information provided by the state diagram should be integrated with the truth tables and timing specification.

The truth tables provide complementary information to the state diagram; they clarify the device behavior and the applied restrictions when considering the actual state of all the banks.

For the command definition, see chapter 7.4 “**Command Definitions and Timing Diagrams**”.



7.1.1 Simplified Bus Interface State Diagram

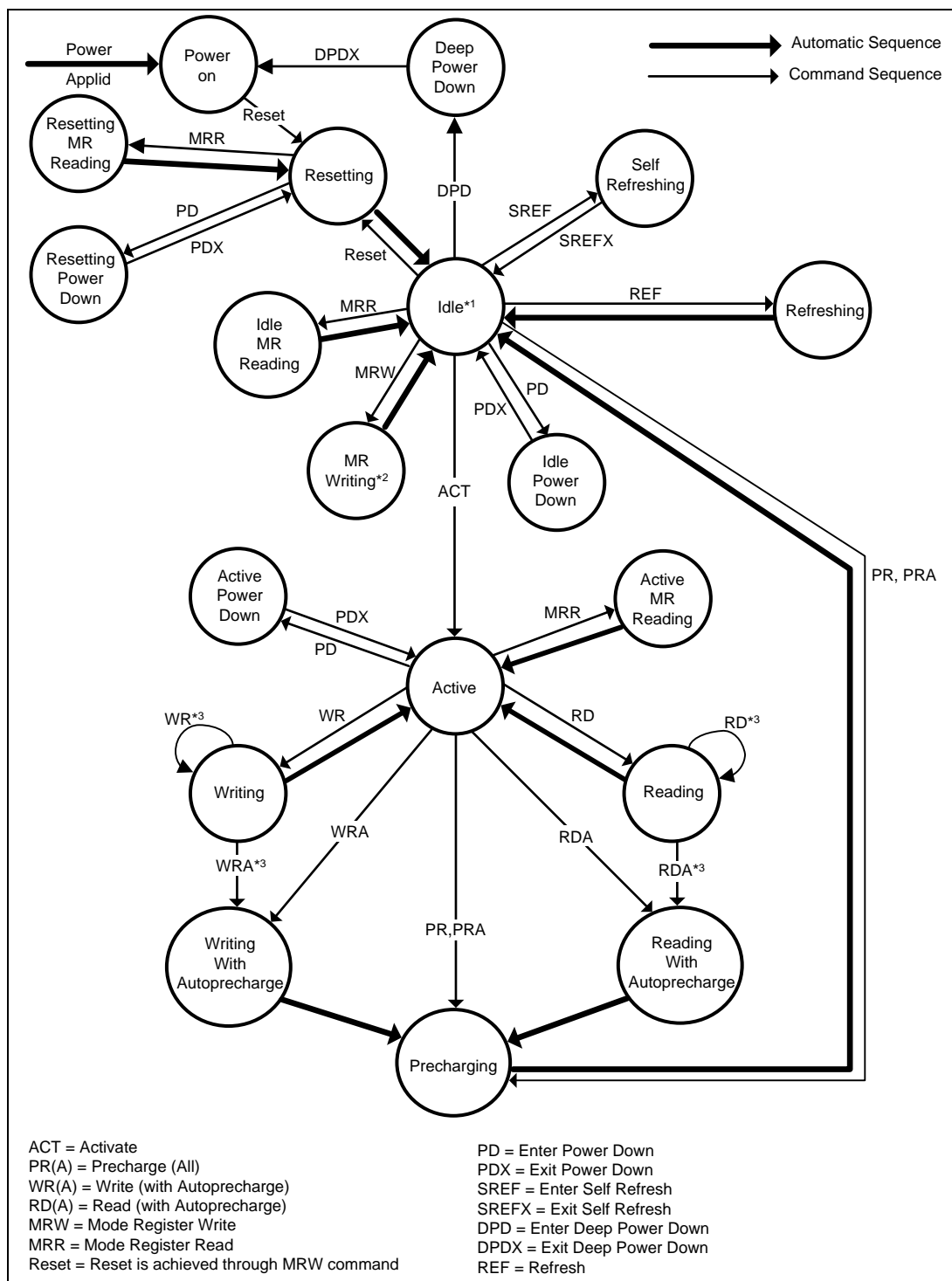

Figure 1: Simplified Bus Interface State Diagram

Notes:

- In the Idle state, all banks are precharged.
- In the case of MRW to enter CA Training mode or Write Leveling Mode, the state machine will not automatically return to the Idle state. In these cases an additional MRW command is required to exit either operating mode and return to the idle state. See the "CA Training Mode" or "Write Leveling Mode" sections.
- Terminated bursts are not allowed. For these state transitions, the burst operation must be completed before the transition can occur.
- Use caution with this diagram. It is intended to provide a floorplan of the possible state transitions and commands to control them, not all details. In particular, situations involving more than one bank are not captured in full detail.



7.2 Power-up, Initialization, and Power-Off

7.2.1 Voltage Ramp and Device Initialization

The following sequence must be used to power up LPDDR3 device. Unless specified otherwise, this procedure is mandatory.

1. Voltage Ramp

While applying power (after T_a), CKE must be held LOW ($\leq 0.2 \times VDDCA$) and all other inputs must be between VIL_{min} and VIH_{max} . The device outputs remain at High-Z while CKE is held LOW.

Following the completion of the voltage ramp (T_b), CKE must be maintained LOW. DQ, DM, DQS_t and DQS_c voltage levels must be between VSS and VDDQ during voltage ramp to avoid latch-up. CK_t, CK_c, CS_n, and CA input levels must be between VSS and VDDCA during voltage ramp to avoid latch-up. Voltage ramp power supply requirements are provided in Table below.

Voltage Ramp Conditions

After...	Applicable Conditions
Ta is reached	VDD1 must be greater than VDD2—200mV
	VDD1 and VDD2 must be greater than VDDCA—200mV
	VDD1 and VDD2 must be greater than VDDQ—200mV
	VREF must always be less than all other supply voltages

Notes:

1. T_a is the point when any power supply first reaches 300 mV.
2. Noted conditions apply between T_a and power-off (controlled or uncontrolled).
3. T_b is the point at which all supply and reference voltages are within their defined operating ranges.
4. Power ramp duration t_{INIT0} ($T_b - T_a$) must not exceed 20 mS.
5. The voltage difference between of VSS pin must not exceed 100 mV.

Beginning at T_b , CKE must remain LOW for at least t_{INIT1} , after which CKE can be asserted HIGH. The clock must be stable at least t_{INIT2} prior to the first CKE LOW-to-HIGH transition (T_c). CKE, CS_n, and CA inputs must observe setup and hold requirements (t_{IS} , t_{IH}) with respect to the first rising clock edge (as well as to subsequent falling and rising edges).

If any MRR commands are issued, the clock period must be within the range defined for t_{CKb} . MRW commands can be issued at normal clock frequencies as long as all AC timings are met. Some AC parameters (for example, t_{DQSCK}) could have relaxed timings (such as t_{DQSCKb}) before the system is appropriately configured. While keeping CKE HIGH, NOP commands must be issued for at least t_{INIT3} (T_d). The ODT input signal may be in undefined state until t_{IS} before CKE is registered HIGH. When CKE is registered HIGH, the ODT input signal shall be statically held at either LOW or HIGH. The ODT input signal remains static until the power up initialization sequence is finished, including the expiration of t_{ZQINIT} .

2. RESET Command:

After t_{INIT3} is satisfied, the MRW RESET command must be issued (T_d).

A PRECHARGE ALL command can be issued prior to the MRW RESET command. Wait at least t_{INIT4} while keeping CKE asserted and issuing NOP commands. Only NOP commands are allowed during time t_{INIT4} .



3. MRRs and Device Auto Initialization (DAI) Polling:

After tINIT4 is satisfied (Te), only MRR commands and power-down entry/exit commands are supported. After Te, CKE can go LOW in alignment with power-down entry and exit specifications. MRR commands are only valid at this time if the CA bus does not need to be trained. CA Training may only begin after time Tf. User may issue MRR command to poll the DAI bit which will indicate if device auto initialization is complete; once DAI bit indicates completion, SDRAM is in idle state. Device will also be in idle state after tINIT5(max) has expired (whether or not DAI bit has been read by MRR command). As the memory output buffers are not properly configured by Te, some AC parameters must have relaxed timings before the system is appropriately configured.

After the DAI bit (MR0, DAI) is set to zero by the memory device (DAI complete), the device is in the idle state (Tf). DAI status can be determined by issuing the MRR command to MR0. The device sets the DAI bit no later than tINIT5 after the RESET command. The controller must wait at least tINIT5(max) or until the DAI bit is set before proceeding.

4. ZQ Calibration:

If CA Training is not required, the MRW initialization calibration (ZQ_CAL) command can be issued to the memory (MR10) after time Tf. If CA Training is required, the CA Training may begin at time Tf. No other CA commands (other than RESET or NOP) may be issued prior to the completion of CA Training. At the completion of CA Training (Tf'), the MRW initialization calibration (ZQ_CAL) command can be issued to the memory (MR10).

This command is used to calibrate output impedance over process, voltage, and temperature. In systems where more than one LPDDR3 device exists on the same bus, the controller must not overlap MRW ZQ_CAL commands. The device is ready for normal operation after tZQINIT.

5. Normal Operation:

After tZQINIT (Tg), MRW commands must be used to properly configure the memory (for example the output buffer drive strength, latencies, etc.). Specifically, MR1, MR2, and MR3 must be set to configure the memory for the target frequency and memory configuration.

After the initialization sequence is complete, the device is ready for any valid command. After Tg, the clock frequency can be changed using the procedure described in this specification.

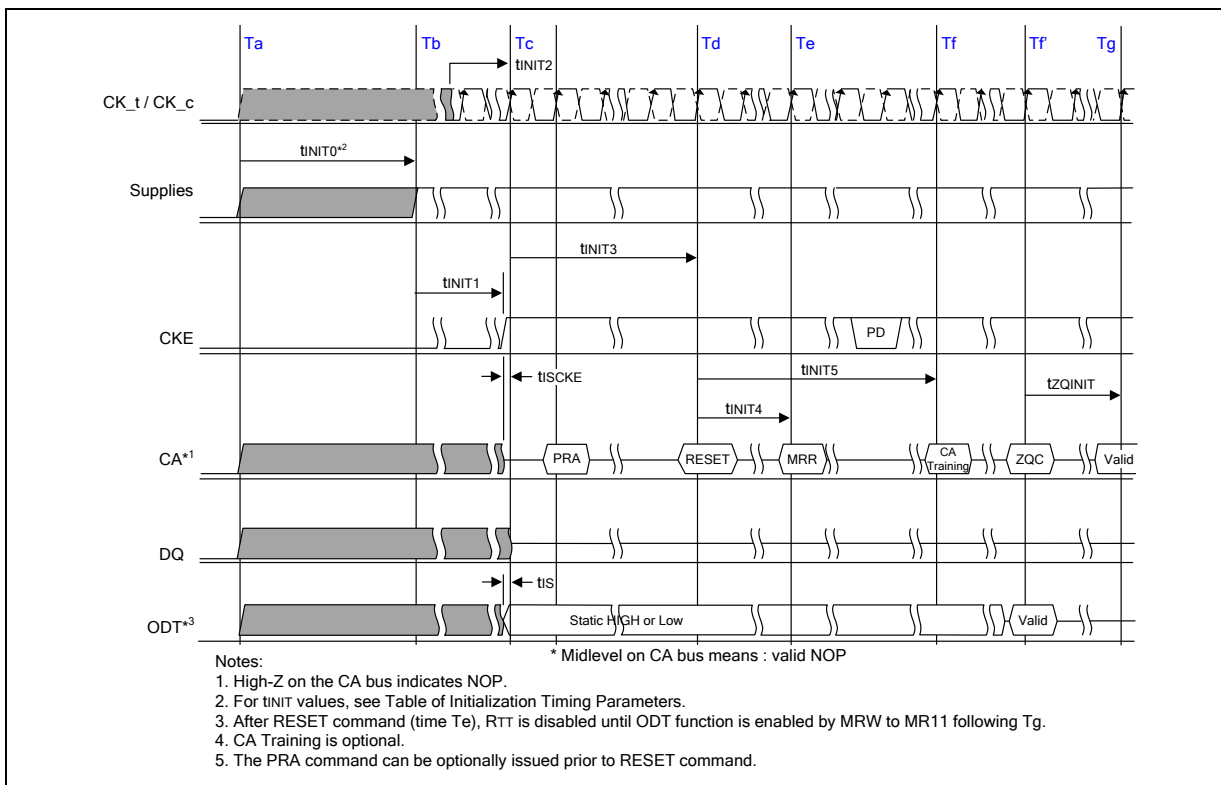

Figure 2: Voltage Ramp and Initialization Sequence



Initialization Timing Parameters

Parameter	Value		Unit	Comment
	Min	Max		
tINIT0	-	20	mS	Maximum voltage-ramp time
tINIT1	100	-	nS	Minimum CKE LOW time after completion of voltage ramp
tINIT2	5	-	tCK	Minimum stable clock before first CKE HIGH
tINIT3	200	-	μS	Minimum idle time after first CKE assertion
tINIT4	1	-	μS	Minimum idle time after RESET command
tINIT5*1	-	10	μS	Maximum duration of device auto initialization
tZQINIT	1	-	μS	ZQ initial calibration
tCKb	18	100	nS	Clock cycle time during boot

Note:

1. If DAI bit is not read via MRR, SDRAM will be in idle state after tINIT5(max) has expired.

7.2.2 Initialization after Reset (without Power ramp)

If the RESET command is issued before or after the power-up initialization sequence, the re-initialization procedure must begin at Td.

7.2.3 Power-off Sequence

The following procedure is required to power off the device.

While power off, CKE must be held LOW ($\leq 0.2 \times VDDCA$), all other inputs must be between VILmin and VIHmax. The device outputs remain at High-Z while CKE is held LOW.

DQ, DM, DQS_t and DQS_c voltage levels must be between VSS and VDDQ during power-off sequence to avoid latch-up. CK_t, CK_c, CS_n and CA input levels must be between VSS and VDDCA during power-off sequence to avoid latch-up.

Tx is the point where any power supply drops below the minimum value specified.

Tz is the point where all power supplies are below 300 mV. After Tz, the device is powered off.

Power Supply conditions

Between...	Applicable Conditions
Tx and Tz	VDD1 must be greater than VDD2—200 mV
Tx and Tz	VDD1 must be greater than VDDCA—200 mV
Tx and Tz	VDD1 must be greater than VDDQ—200 mV
Tx and Tz	VREF must always be less than all other supply voltages

The voltage difference between of VSS pin must not exceed 100 mV.

7.2.4 Uncontrolled Power-Off Sequence

When an uncontrolled power-off occurs, the following conditions must be met:

At Tx, when the power supply drops below the minimum values specified, all power supplies must be turned off and all power-supply current capacity must be at zero, except for any static charge remaining in the system.

After Tz (the point at which all power supplies first reach 300 mV), the device must power off. During this period, the relative voltage between power supplies is uncontrolled. VDD1 and VDD2 must decrease with a slope lower than 0.5 V/μS between Tx and Tz.

An uncontrolled power-off sequence can occur a maximum of 400 times over the life of the device.

Timing Parameters Power-Off

Symbol	Value		Unit	Comment
	min	max		
tPOFF	-	2	S	Maximum Power-Off Ramp Time



7.3 Mode Register Definition

7.3.1 Mode Register Assignment and Definition

The table listed below shows the mode registers for LPDDR3 SDRAM. Each register is denoted as “R” if it can be read but not written, “W” if it can be written but not read, and “R/W” if it can be read and written. A Mode Register Read command is used to read a mode register. A Mode Register Write command is used to write a mode register.

7.3.1.1 Mode Register Assignment

MR#	MA[7:0]	Function	Access	OP7	OP6	OP5	OP4	OP3	OP2	OP1	OP0
0	00H	Device Info.	R	RL3	WL (Set B)	(RFU)	RZQI		(RFU)		DAI
1	01H	Device Feature 1	W	nWR (for AP)			(RFU)	BL			
2	02H	Device Feature 2	W	WR Lev	WL Select	(RFU)	nWRE	RL & WL			
3	03H	I/O Config-1	W	(RFU)				DS			
4	04H	Refresh Rate	R	TUF	(RFU)				Refresh Rate		
5	05H	Basic Config-1	R	Manufacturer ID							
6	06H	Basic Config-2	R	Revision ID1							
7	07H	Basic Config-3	R	Revision ID2							
8	08H	Basic Config-4	R	I/O width		Density				Type	
9	09H	(Reserved)	W	(RFU)							
10	0AH	I/O Calibration	W	Calibration Code							
11	0BH	ODT Feature	-	(RFU)					PD CTL	DQ ODT	
12:15	0CH~0FH	(Reserved)	-	(RFU)							
16	10H	PASR_Bank	W	PASR Bank Mask							
17	11H	PASR_Seg	W	PASR Segment Mask							
18-31	12H~1FH	(Reserved)	-	(RFU)							
32	20H	DQ Calibration Pattern A	R	DQ Calibration Pattern A							
33:39	21H~27H	(Do Not Use)	-	(RFU)							
40	28H	DQ Calibration Pattern B	R	DQ Calibration Pattern B							
41	29H	CA Training 1	W	CA Training 1							
42	2AH	CA Training 2	W	CA Training 2							
43:47	2BH~2FH	(Do Not Use)	-	(RFU)							
48	30H	CA Training 3	W	CA Training 3							
49:62	31H~3EH	(Reserved)	-	(RFU)							
63	3FH	Reset	W	X							
64:255	40H~FFH	(Reserved)	-	(RFU)							

Notes:

1. RFU bits shall be set to '0' during mode register writes.
2. RFU bits shall be read as '0' during mode register reads.
3. All mode registers that are specified as RFU or write-only shall return undefined data when read and DQS_t, DQS_c shall be toggled.
4. All mode registers that are specified as RFU shall not be written.
5. Writes to read-only registers shall have no impact on the functionality of the device.



7.3.2 MR0_Device Information (MA[7:0] = 00H)

OP7	OP6	OP5	OP4	OP3	OP2	OP1	OP0
RL3	WL (Set B) Support	(RFU)	RZQI		(RFU)		DAI

DAI (Device Auto-Initialization Status)	Read-only	OP0	0b : DAI complete 1b : DAI still in progress	
RZQI (Built in Self Test for RZQ Information)	Read-only	OP[4:3]	00b : RZQ self test not executed. 01b : ZQ-pin may connect to VDDCA or float 10b : ZQ-pin may short to GND 11b : ZQ-pin self test completed, no error condition detected (ZQ-pin may not connect to VDDCA or float nor short to GND)	1-4
WL (Set B) Support	Read-only	OP[6]	0b : DRAM does not support WL (Set B)	
RL3 Option Support	Read-only	OP[7]	0b : DRAM does not support RL=3, nWR=3, WL=1	

Notes:

- RZQI will be set upon completion of the MRW ZQ Initialization Calibration command.
- If ZQ is connected to VDDCA to set default calibration, OP[4:3] shall be set to 01. If ZQ is not connected to VDDCA, either OP[4:3]=01 or OP[4:3]=10 might indicate a ZQ-pin assembly error. It is recommended that the assembly error is corrected.
- In the case of possible assembly error (either OP[4:3]=01 or OP[4:3]=10 per Note 4), the LPDDR3 device will default to factory trim settings for RON, and will ignore ZQ calibration commands. In either case, the system may not function as intended.
- In the case of the ZQ self-test returning a value of 11b, this result indicates that the device has detected a resistor connection to the ZQ pin. However, this result cannot be used to validate the ZQ resistor value or that the ZQ resistor tolerance meets the specified limits (i.e. 240Ω ±1%).

7.3.3 MR1_Device Feature 1 (MA[7:0] = 01H)

OP7	OP6	OP5	OP4	OP3	OP2	OP1	OP0
nWR (for AP)			(RFU)		BL		

BL	Write-only	OP[2:0]	011b : BL8 (default) All others : Reserved	
nWR	Write-only	OP[7:5]	If nWRE (MR2 OP<4>) = 0 001b : nWR=3 100b : nWR=6 110b : nWR=8 111b : nWR=9 If nWRE (MR2 OP<4>) = 1 000b : nWR=10 (default) 001b : nWR=11 010b : nWR=12 100b : nWR=14 110b : nWR=16 All others : Reserved	1

Note:

- Programmed value in nWR register is the number of clock cycles which determines when to start internal precharge operation for a write burst with AP enabled. It is determined by RU(tWR/tCK).



7.3.3.1 Burst Sequence

C2	C1	C0	BL	Burst Cycle Number and Burst Address Sequence							
				1	2	3	4	5	6	7	8
0 _b	0 _b	0 _b	8	0	1	2	3	4	5	6	7
0 _b	1 _b	0 _b		2	3	4	5	6	7	0	1
1 _b	0 _b	0 _b		4	5	6	7	0	1	2	3
1 _b	1 _b	0 _b		6	7	0	1	2	3	4	5

Notes:

1. C0 input is not present on CA bus. It is implied zero.
2. The burst address represents C2 – C0.

7.3.4 MR2_Device Feature 2 (MA[7:0] = 02H)

OP7	OP6	OP5	OP4	OP3	OP2	OP1	OP0
WR Lev	WL Select	(RFU)	nWRE	RL & WL			

RL & WL	Write-only	OP[3:0]	OP<6>=0 (WL Set A, default) 0001_b : (Reserved) 0100_b : RL = 6 / WL = 3 (≤400 MHz) 0110_b : RL = 8 / WL = 4 (≤533 MHz) 0111_b : RL = 9 / WL = 5 (≤600 MHz) 1000_b : RL = 10 / WL = 6 (≤667 MHz, default) 1001_b : RL = 11 / WL = 6 (≤733 MHz) 1010_b : RL = 12 / WL = 6 (≤800 MHz) 1100_b : RL = 14 / WL = 8 (≤933 MHz) 1110_b : RL = 16 / WL = 8 (≤1066 MHz) All others : Reserved
nWRE	Write-only	OP[4]	0_b : enable nWR programming ≤ 9 1_b : enable nWR programming > 9 (default)
WL Select	Write-only	OP[6]	0_b : Select WL Set A (default) 1_b : (Reserved)
WR Leveling	Write-only	OP[7]	0_b : Disable (default) 1_b : Enable



7.3.5 MR3_I/O Configuration 1 (MA[7:0] = 03H)

OP7	OP6	OP5	OP4	OP3	OP2	OP1	OP0
(RFU)				DS			

DS	Write-only	OP[3:0]	0001_b : 34.3Ω typical pull-down/pull-up 0010_b : 40Ω typical pull-down/pull-up (default) 0011_b : 48Ω typical pull-down/pull-up 0100_b : 60Ω typical pull-down/pull-up 0110_b : 80Ω typical pull-down/pull-up 1001_b : 34.3Ω typical pull-down, 40Ω typical pull-up 1010_b : 40Ω typical pull-down, 48Ω typical pull-up 1011_b : 34.3Ω typical pull-down, 48Ω typical pull-up All others : Reserved
----	------------	---------	---

7.3.6 MR4_Device Temperature (MA[7:0] = 04H)

OP7	OP6	OP5	OP4	OP3	OP2	OP1	OP0
TUF	(RFU)				SDRAM Refresh Rate		

SDRAM Refresh Rate, Refresh Multiplier (RM)	Read-only	OP[2:0]	000_b : SDRAM Low temperature operating limit exceeded 001_b : RM = 4; tREFIM = 4 x tREFI, tREFIMpb = 4 x tREFIpb, tREFWM = 4 x tREFW 010_b : RM = 2; tREFIM = 2 x tREFI, tREFIMpb = 2 x tREFIpb, tREFWM = 2 x tREFW 011_b : RM = 1; tREFIM = tREFI, tREFIMpb = tREFIpb, tREFWM = tREFW (≤ 85°C) 100_b : RM = 0.5; tREFIM = 0.5 x tREFI, tREFIMpb = 0.5 x tREFIpb, tREFWM = 0.5 x tREFW, do not de-rate SDRAM AC timing 101_b : RM = 0.25; tREFIM = 0.25 x tREFI, tREFIMpb = 0.25 x tREFIpb, tREFWM = 0.25 x tREFW, do not de-rate SDRAM AC timing 110_b : RM = 0.25; tREFIM = 0.25 x tREFI, tREFIMpb = 0.25 x tREFIpb, tREFWM = 0.25 x tREFW, de-rate SDRAM AC timing 111_b : SDRAM High temperature operating limit exceeded
Temperature Update Flag (TUF)	Read-only	OP7	0_b : OP[2:0] value has not changed since last read of MR4 1_b : OP[2:0] value has changed since last read of MR4

Notes:

1. A Mode Register Read from MR4 will reset OP7 to '0'.
2. OP7 is reset to '0' at power-up. OP[2:0] bits are undefined after power-up.
3. If OP2 equals '1', the device temperature is greater than 85°C.
4. OP7 is set to '1' if OP[2:0] has changed at any time since the last read of MR4.
5. SDRAM might not operate properly when OP[2:0] = 000b or 111b.
6. For specified operating temperature range and maximum operating temperature, refer to "Operating Temperature Range" table.
7. LPDDR3 devices shall be derated by adding 1.875 nS to the following core timing parameters: tRCD, tRC, tRAS, tRP, and tRRD. tDQSCK shall be de-rated according to the tDQSCK de-rating value in "LPDDR3 AC Timing" table. Prevailing clock frequency spec and related setup and hold timings shall remain unchanged.
8. See "Temperature Sensor" section for information on the recommended frequency of reading MR4.

7.3.7 MR5_Basic Configuration 1 (MA[7:0] = 05H)

OP7	OP6	OP5	OP4	OP3	OP2	OP1	OP0
LPDDR3 Manufacturer ID							

LPDDR3 Manufacturer ID	Read-only	OP[7:0]	0000 1000b: Winbond
------------------------	-----------	---------	---------------------



7.3.8 MR6_Basic Configuration 2 (MA[7:0] = 06H)

OP7	OP6	OP5	OP4	OP3	OP2	OP1	OP0
Revision ID1							

Revision ID1	Read-only	OP[7:0]	TBD
--------------	-----------	---------	-----

Note: MR6 is vendor specific.

7.3.9 MR7_Basic Configuration 3 (MA[7:0] = 07H)

OP7	OP6	OP5	OP4	OP3	OP2	OP1	OP0
Revision ID2							

Revision ID2	Read-only	OP[7:0]	TBD
--------------	-----------	---------	-----

Note: MR7 is vendor specific.

7.3.10 MR8_Basic Configuration 4 (MA[7:0] = 08H)

OP7	OP6	OP5	OP4	OP3	OP2	OP1	OP0
I/O width		Density				Type	

Type	Read-only	OP[1:0]	11 _b : LPDDR3 SDRAM All others: Reserved
Density	Read-only	OP[5:2]	0100 _b : 1Gb All others: Reserved
I/O width	Read-only	OP[7:6]	00 _b : x32 01 _b : x16 All others: Reserved

7.3.11 MR9_(Reserved) (MA[7:0] = 09H)

7.3.12 MR10_Calibration (MA[7:0] = 0AH)

OP7	OP6	OP5	OP4	OP3	OP2	OP1	OP0
Calibration Code							

Calibration Code	Write-only	OP[7:0]	0xFF: Calibration command after initialization 0xAB: Long calibration 0x56: Short calibration 0xC3: ZQ Reset All others: Reserved
------------------	------------	---------	---

Notes:

- Host processor shall not write MR10 with "Reserved" values.
- LPDDR3 devices shall ignore calibration command when a "Reserved" value is written into MR10.
- See AC timing table for the calibration latency.
- If ZQ is connected to VSS through RZQ, either the ZQ calibration function (see section 7.4.13.2 "Mode Register Write ZQ Calibration Command") or default calibration (through the ZQRESET command) is supported. If ZQ is connected to VDDCA, the device operates with default calibration, and ZQ calibration commands are ignored. In both cases, the ZQ connection shall not change after power is applied to the device.
- The MRW ZQ Initialization Calibration command will update MR0 to indicate RZQ pin connection.



7.3.13 MR11_ODT Control (MA[7:0] = 0BH)

OP7	OP6	OP5	OP4	OP3	OP2	OP1	OP0
RFU					PD CTL	DQ ODT	

DQ ODT	Write-only	OP[1:0]	00_b : Disable (Default) 01_b : RZQ /4 10_b : RZQ /2 11_b : RZQ /1
PD Control	Write-only	OP[2]	0_b : ODT disabled by DRAM during power down (default) 1_b : ODT enabled by DRAM during power down

7.3.14 MR12:15_(Reserved) (MA[7:0] = 0CH-OFH)

7.3.15 MR16_PASR_Bank Mask (MA[7:0] = 10H)

OP7	OP6	OP5	OP4	OP3	OP2	OP1	OP0
Bank Mask							

Bank[7:0] Mask	Write-only	OP[7:0]	0_b : Refresh enable to the bank (= unmasked, default) 1_b : Refresh blocked (= masked)
----------------	------------	---------	--

OP	Bank Mask	8-Bank SDRAM
0	XXXXXXX1	Bank 0
1	XXXXXX1X	Bank 1
2	XXXXX1XX	Bank 2
3	XXXX1XXX	Bank 3
4	XXX1XXXX	Bank 4
5	XX1XXXXX	Bank 5
6	X1XXXXXX	Bank 6
7	1XXXXXXX	Bank 7

7.3.16 MR17_PASR_Segment Mask (MA[7:0] = 11H)

OP7	OP6	OP5	OP4	OP3	OP2	OP1	OP0
Segment Mask							

Segment[7:0] Mask	Write-only	OP[7:0]	0_b : Refresh enable to the bank (= unmasked, default) 1_b : Refresh blocked (= masked)
-------------------	------------	---------	--

Segment	OP	Segment Mask	R[12:10]
0	0	XXXXXXX1	000b
1	1	XXXXXX1X	001b
2	2	XXXXX1XX	010b
3	3	XXXX1XXX	011b
4	4	XXX1XXXX	100b
5	5	XX1XXXXX	101b
6	6	X1XXXXXX	110b
7	7	1XXXXXXX	111b

Note:

1. This table indicates the range of row addresses in each masked segment. X is do not care for a particular segment.



7.3.17 MR18:31_(Reserved) (MA[7:0] = 12H-1FH)

7.3.18 MR32_DQ Calibration Pattern A (MA[7:0] = 20H)

Reads to MR32 return DQ Calibration Pattern "A". See section 7.4.12.2 "DQ Calibration".

7.3.19 MR33:39_(Do Not Use) (MA[7:0] = 21H-27H)

7.3.20 MR40_DQ Calibration Pattern B (MA[7:0] = 28H)

Reads to MR40 return DQ Calibration Pattern "B". See section 7.4.12.2 "DQ Calibration".

7.3.21 MR41_CA Training_1 (MA[7:0] = 29H)

Writes to MR41 enables CA Training. See section 7.4.13.3 "Mode Register Write – CA Training Mode".

7.3.22 MR42_CA Training_2 (MA[7:0] = 2AH)

Writes to MR42 exits CA Training. See section 7.4.13.3 "Mode Register Write – CA Training Mode".

7.3.23 MR43:47_(Do Not Use) (MA[7:0] = 2BH-2FH)

7.3.24 MR48_CA Training_3 (MA[7:0] = 30H)

Writes to MR48 enables CA Training. See section 7.4.13.3 "Mode Register Write – CA Training Mode".

7.3.25 MR49:62_(Reserved) (MA[7:0] = 31H-3EH)

7.3.26 MR63_Reset (MA[7:0] = 3FH)

OP7	OP6	OP5	OP4	OP3	OP2	OP1	OP0
X or 0xFC							

Note:

1. For additional information on MRW RESET see section 7.4.13.1 "Mode Register Write".

7.3.27 MR64:255_(Reserved) (MA[7:0] = 40H-FFH)



7.4 Command Definitions and Timing Diagrams

7.4.1 Activate Command

The Activate command is issued by holding CS_n LOW, CA0 LOW, and CA1 HIGH at the rising edge of the clock. The bank addresses BA0 to BA2 are used to select the desired bank. Row addresses are used to determine which row to activate in the selected bank. The Activate command must be applied before any Read or Write operation can be executed. The device can accept a Read or Write command at tRCD after the Activate command is issued. After a bank has been activated it must be precharged before another Activate command can be applied to the same bank. The bank active and precharge times are defined as tRAS and tRP, respectively. The minimum time interval between successive Activate commands to the same bank is determined by the RAS cycle time of the device (tRC). The minimum time interval between Activate commands to different banks is tRRD.

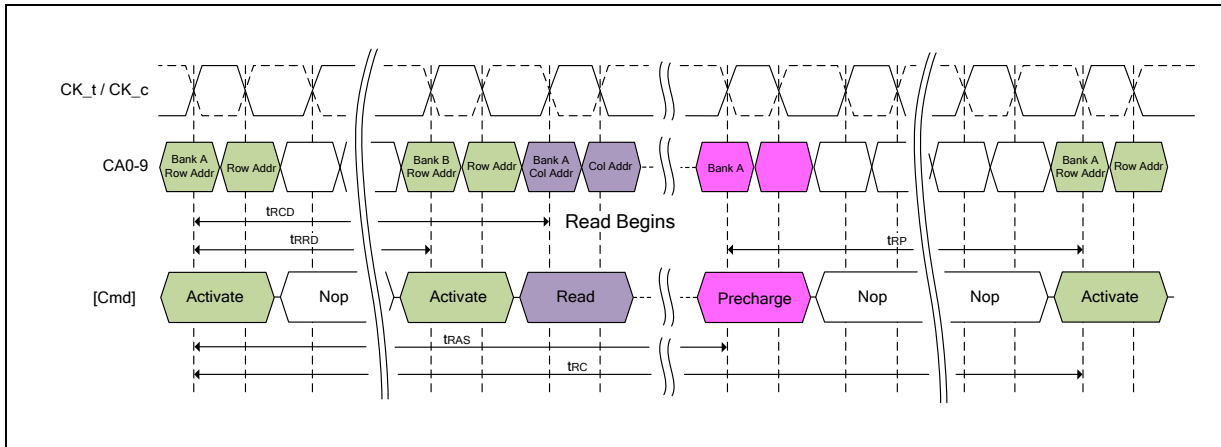

Figure 3 - Activate Command

Note:

1. A PRECHARGE-all command uses tRPab timing, while a single-bank PRECHARGE command uses tRPpb timing. In this figure, tRP is used to denote either an all-bank PRECHARGE or a single-bank PRECHARGE.

7.4.1.1 8-Bank Device Operation

Certain restrictions on operation of the 8-bank LPDDR3 devices must be observed. There are two rules. One rule restricts the number of sequential Activate commands that can be issued; the other provides more time for RAS precharge for a Precharge All command. The rules are as follows:

The 8-bank device Sequential Bank Activation Restriction: No more than 4 banks may be activated (or refreshed, in the case of REFpb) in a rolling tFAW window. The number of clocks in a tFAW period is dependent upon the clock frequency, which may vary. If the clock frequency is not changed over this period, converting to clocks is done by dividing $tFAW[nS]$ by $tCK[nS]$, and rounding up to next integer value. As an example of the rolling window, if $RU(tFAW/tCK)$ is 10 clocks, and an Activate command is issued in clock N, no more than three further Activate commands can be issued at or between clock N+1 and N+9. REFpb also counts as bank activation for the purposes of tFAW. If the clock frequency is changed during the tFAW period, the rolling tFAW window may be calculated in clock cycles by adding up the time spent in each clock period. The tFAW requirement is met when the previous n clock cycles exceeds the tFAW time.

The 8-bank device Precharge All Allowance: tRP for a Precharge All command must equal tRPab, which is greater than tRPpb.

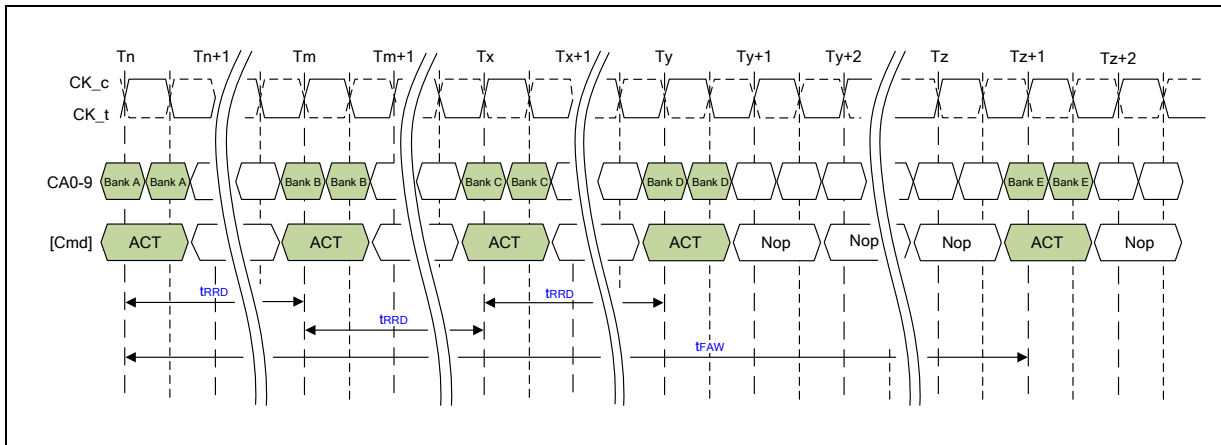

Figure 4 - tFAW Timing

7.4.2 Command Input Signal Timing Definition

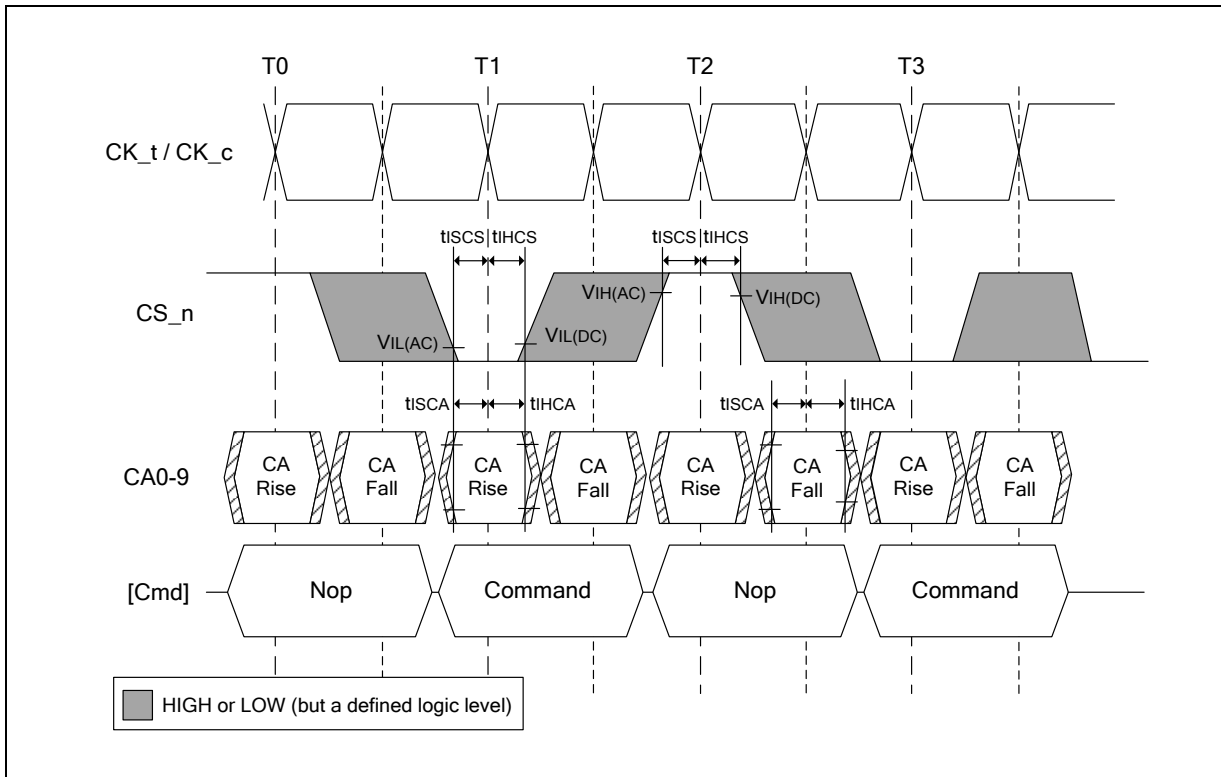

Figure 5 - Command Input Setup and Hold Timing

Note:

1. Setup and hold conditions also apply to the CKE pin. See section related to power down for timing diagrams related to the CKE pin.



7.4.2.1 CKE Input Setup and Hold Timing

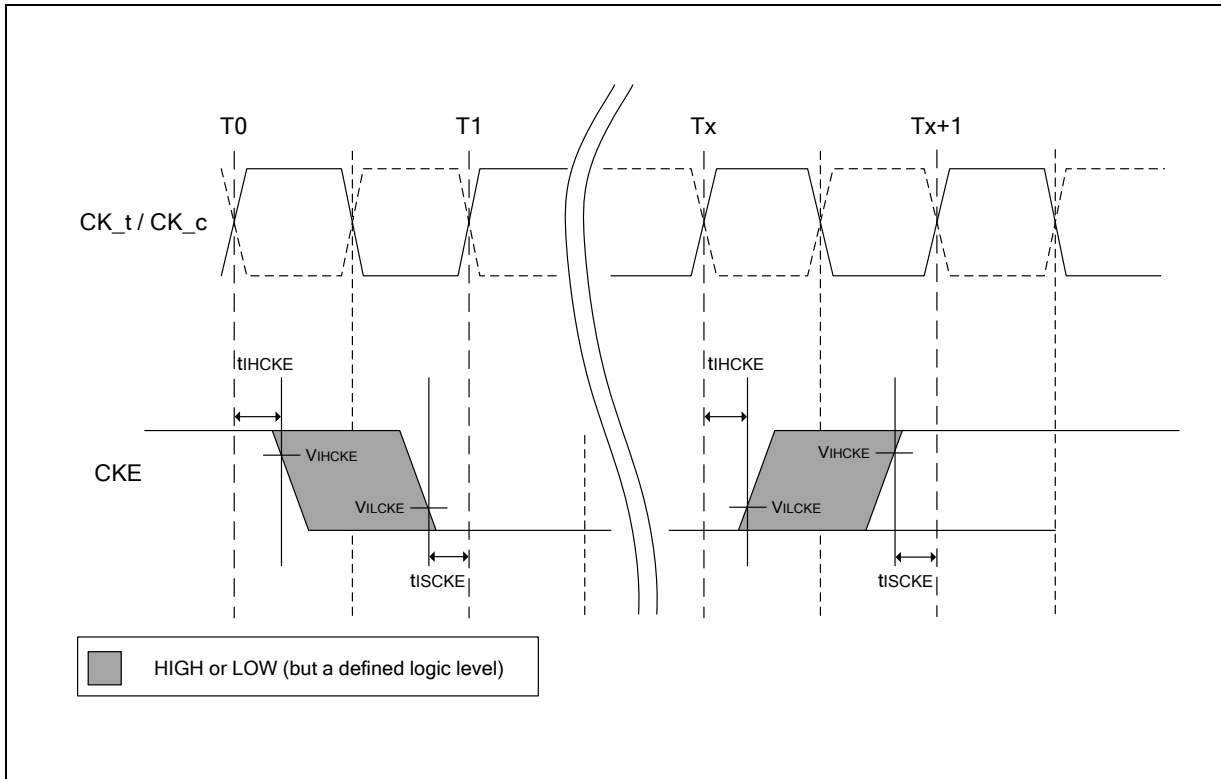

Figure 6 - CKE Input Setup and Hold Timing

Note:

1. After CKE is registered LOW, CKE signal level shall be maintained below VILCKE for tCKE specification (LOW pulse width).
2. After CKE is registered HIGH, CKE signal level shall be maintained above VIHCKE for tCKE specification (HIGH pulse width).

7.4.3 Read and Write Access Modes

After a bank has been activated, a read or write cycle can be executed. This is accomplished by setting CS_n LOW, CA0 HIGH, and CA1 LOW at the rising edge of the clock. CA2 must also be defined at this time to determine whether the access cycle is a read operation (CA2 HIGH) or a write operation (CA2 LOW).

The LPDDR3 SDRAM provides a fast column access operation. A single Read or Write Command will initiate a burst read or write operation on successive clock cycles. Burst interrupts are not allowed.

7.4.4 Burst Read Operation

The Burst Read command is initiated with CS_n LOW, CA0 HIGH, CA1 LOW and CA2 HIGH at the rising edge of the clock. The command address bus inputs CA5_r-CA6_r and CA1_f-CA9_f determine the starting column address for the burst. The Read Latency (RL) is defined from the rising edge of the clock on which the Read Command is issued to the rising edge of the clock from which the tDQSCK delay is measured. The first valid data is available RL x tCK + tDQSCK + tDQSQ after the rising edge of the clock where the Read Command is issued. The data strobe output is driven LOW tRPRE before the first valid rising strobe edge. The first bit of the burst is synchronized with the first rising edge of the data strobe. Each subsequent data-out appears on each DQ pin, edge-aligned with the data strobe. The RL is programmed in the mode registers. Pin timings for the data strobe are measured relative to the crosspoint of DQS_t and its complement, DQS_c.

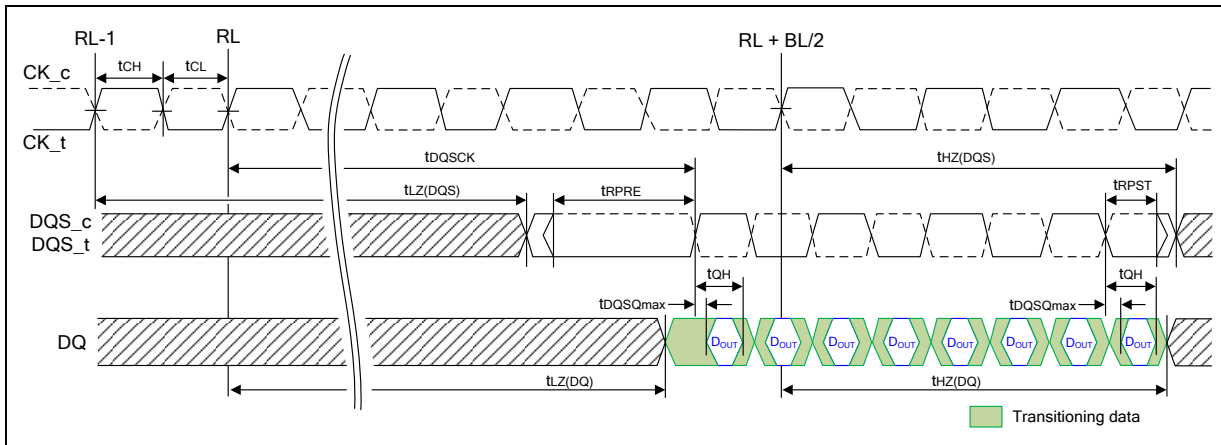

Figure 7 - Read Output Timing

Notes:

1. tDQSCK can span multiple clock periods.
2. An effective burst length of 8 is shown.

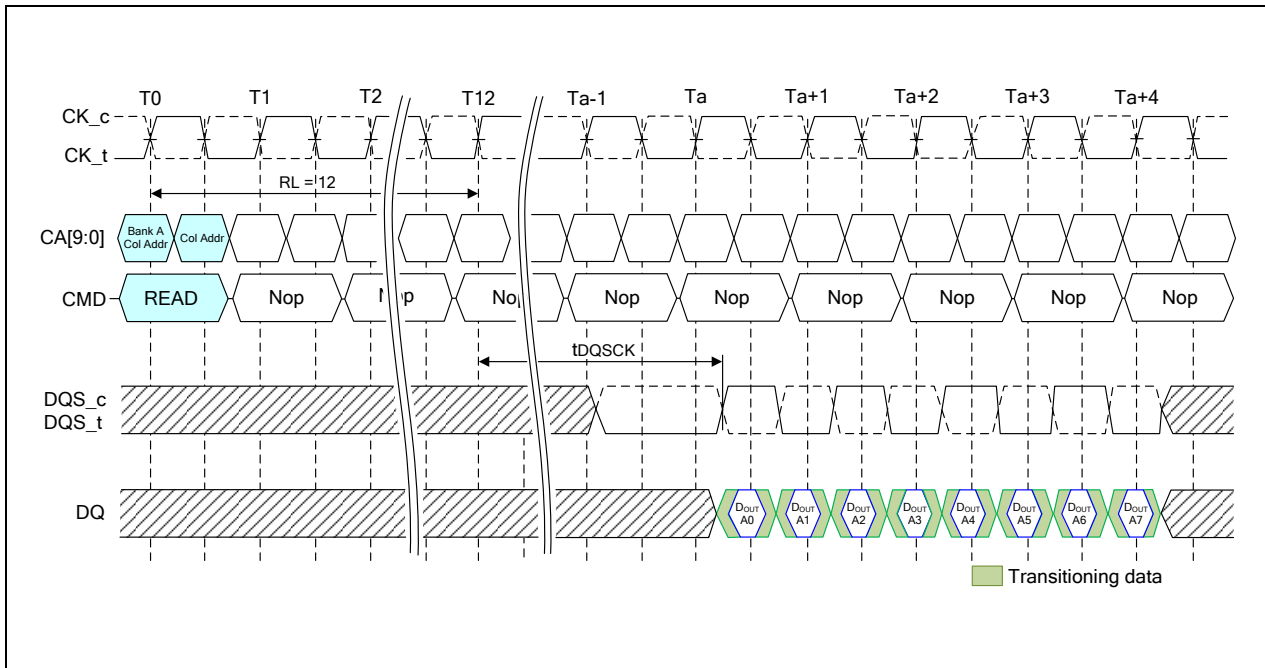

Figure 8 - Burst Read: RL = 12, BL = 8, tDQSCK > tCK

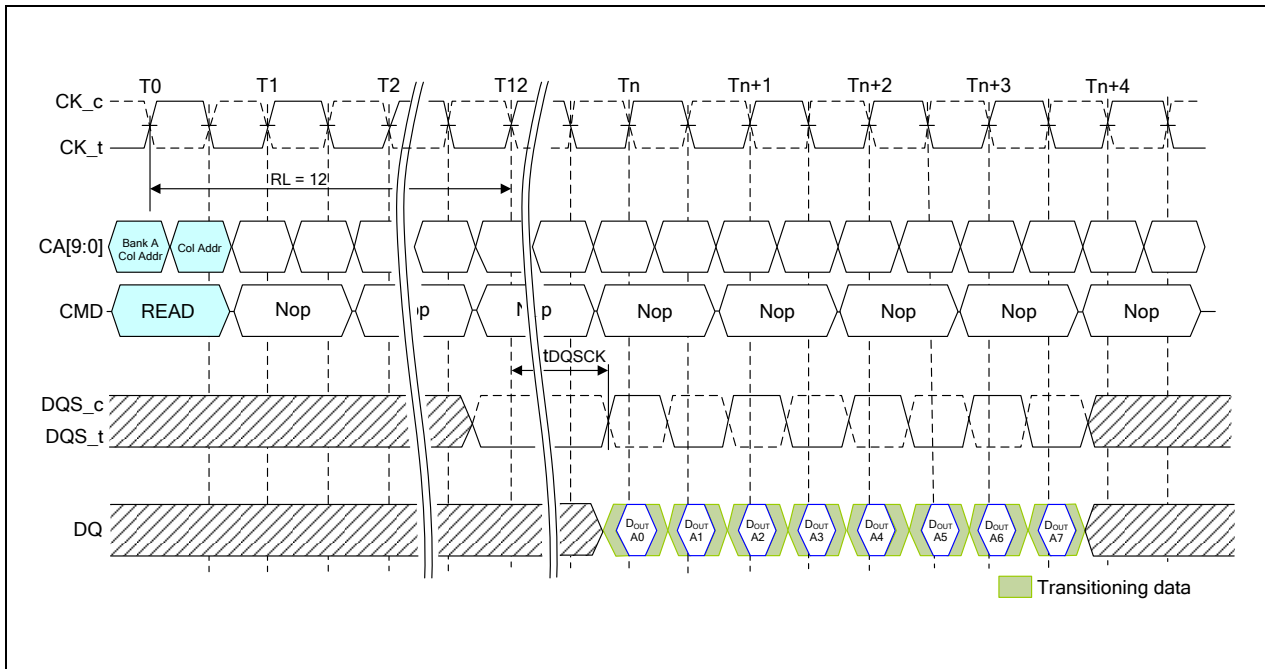

Figure 9 - Burst Read: RL = 12, BL = 8, tDQSK < tCK

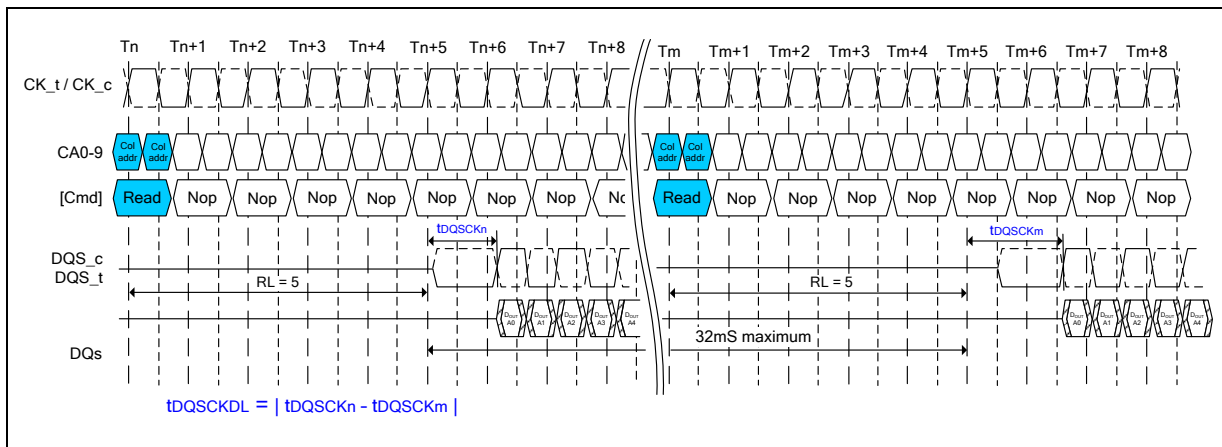

Figure 10 - tDQSKDL timing

Note:

1. tDQSKDLmax is defined as the maximum of ABS(tDQSKn – tDQSKm) for any {tDQSKn , tDQSKm} Pair within any 32mS rolling window.

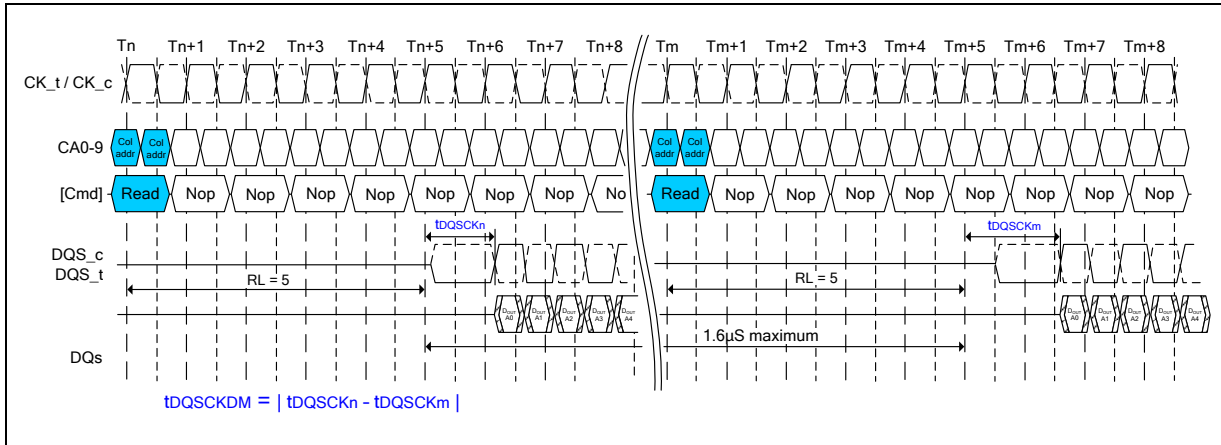

Figure 11 - tDQCKDM timing

Note:

1. tDQCKDMmax is defined as the maximum of $ABS(tDQCKn - tDQCKm)$ for any $\{tDQCKn, tDQCKm\}$ pair within any $1.6\mu S$ rolling window.

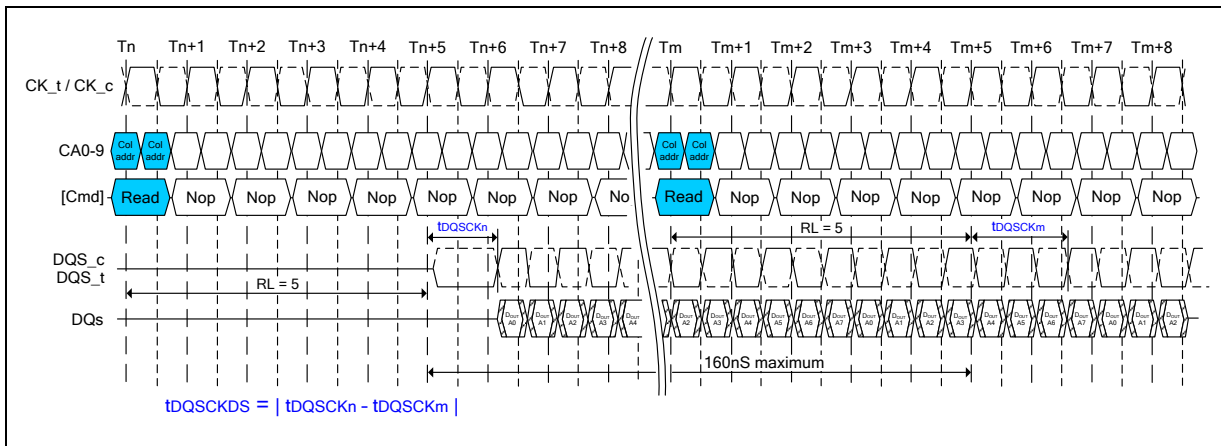

Figure 12 - tDQCKDS timing

Note:

1. tDQCKDSmax is defined as the maximum of $ABS(tDQCKn - tDQCKm)$ for any $\{tDQCKn, tDQCKm\}$ pair for reads within a consecutive burst within any $160nS$ rolling window.

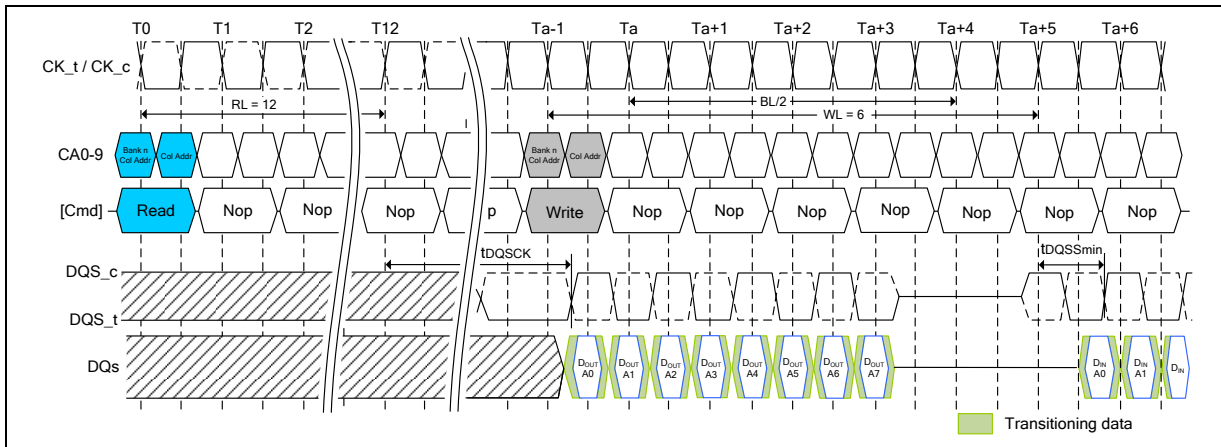

Figure 13 - Burst Read Followed By Burst Write

The minimum time from the burst Read command to the burst Write command is defined by the Read Latency (RL) and the Burst Length (BL). Minimum Read-to-Write latency is $RL + RU(tDQSSCK(MAX))/tCK + BL/2 + 1 - WL$ clock cycles.

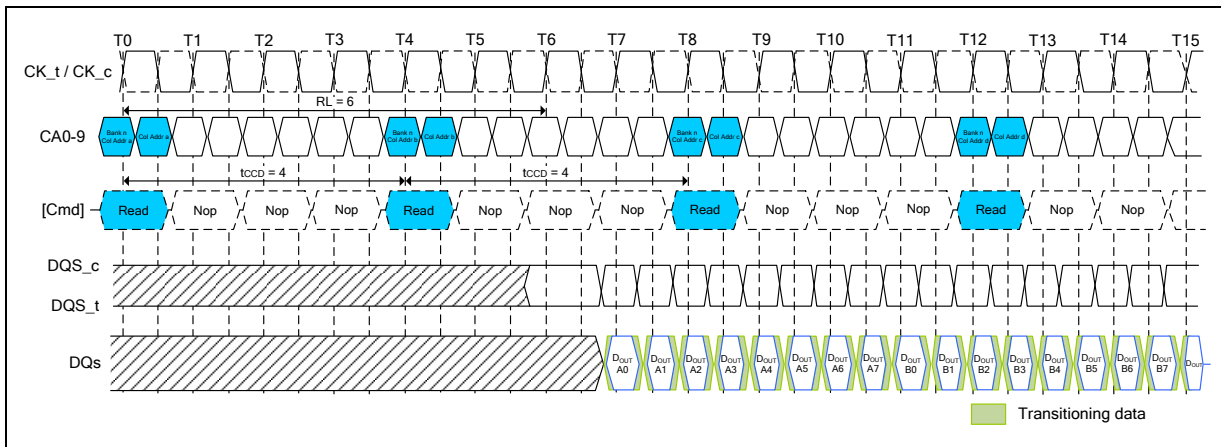

Figure 14 - Seamless Burst Read

The seamless burst Read operation is supported by enabling a Read command at every fourth clock cycle for BL = 8 operation. This operation is supported as long as the banks are activated, whether the accesses read the same or different banks.



7.4.5 Burst Write Operation

The Burst Write command is initiated by having CS_n LOW, CA0 HIGH, CA1 LOW and CA2 LOW at the rising edge of the clock. The command address bus inputs, CA5r-CA6r and CA1f-CA9f, determine the starting column address for the burst. Write Latency (WL) is defined from the rising edge of the clock on which the Write Command is issued to the rising edge of the clock from which the tDQSS delay is measured. The first valid data must be driven WL x tCK + tDQSS from the rising edge of the clock from which the Write command is issued. The data strobe signal (DQS) must be driven for time tWPRE prior as shown in Figure 17 prior to data input. The burst cycle data bits must be applied to the DQ pins tDS prior to the associated edge of the DQS until the 8-bit burst length is completed. After a burst Write operation, tWR must be satisfied before a Precharge command to the same bank can be issued. Pin input timings are measured relative to the crosspoint of DQS_t and its complement, DQS_c.

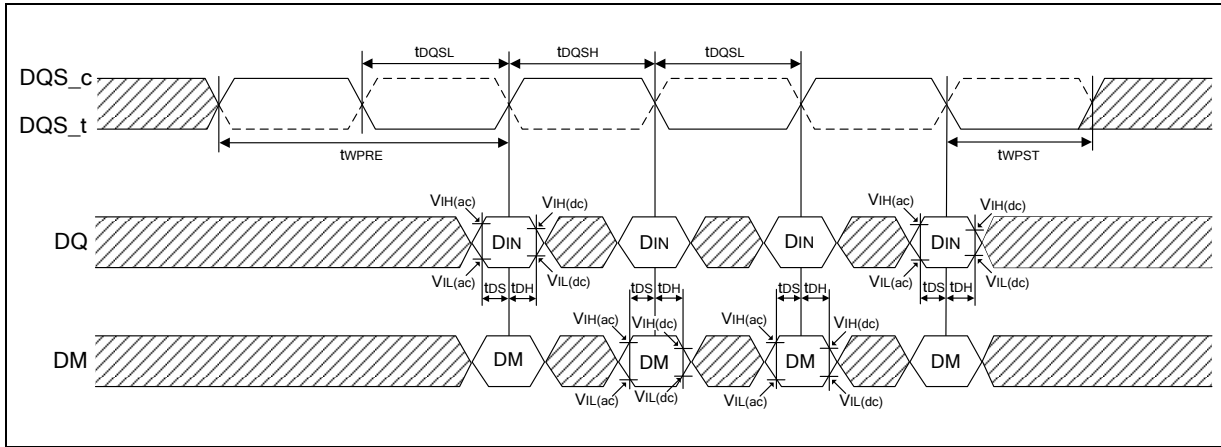

Figure 15 - Data input (write) timing

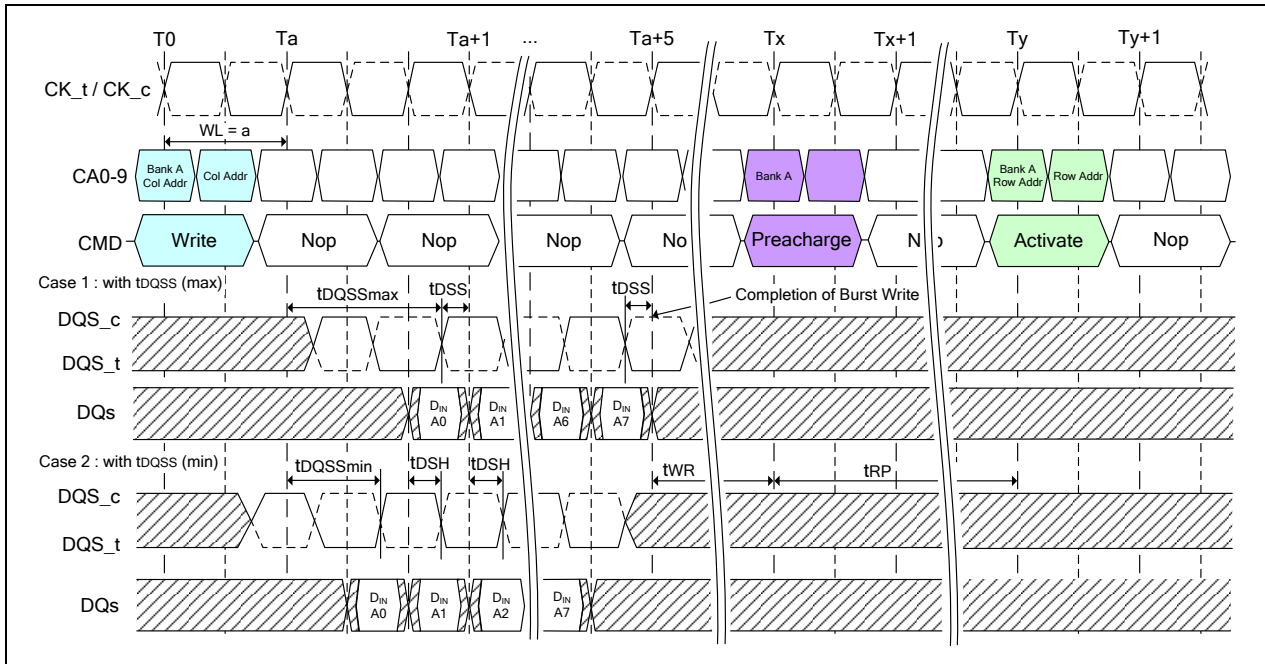

Figure 16 - Burst Write



7.4.5.1 t_{WPRE} Calculation

The method for calculating t_{WPRE} is shown in the figure below.

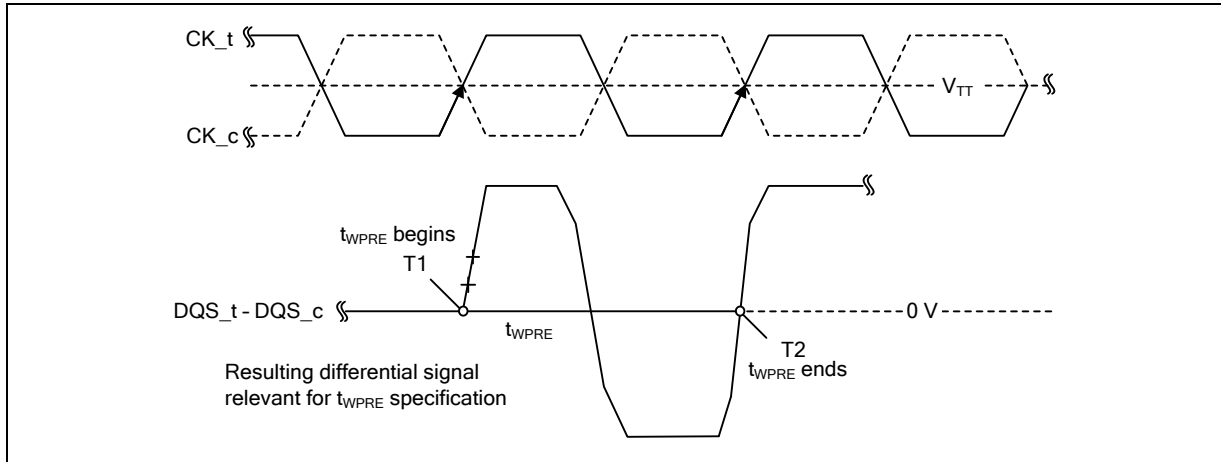

Figure 17 - Method for calculating t_{WPRE} Transitions and Endpoints

7.4.5.2 t_{WPST} Calculation

The method for calculating t_{WPST} is shown in the figure below.

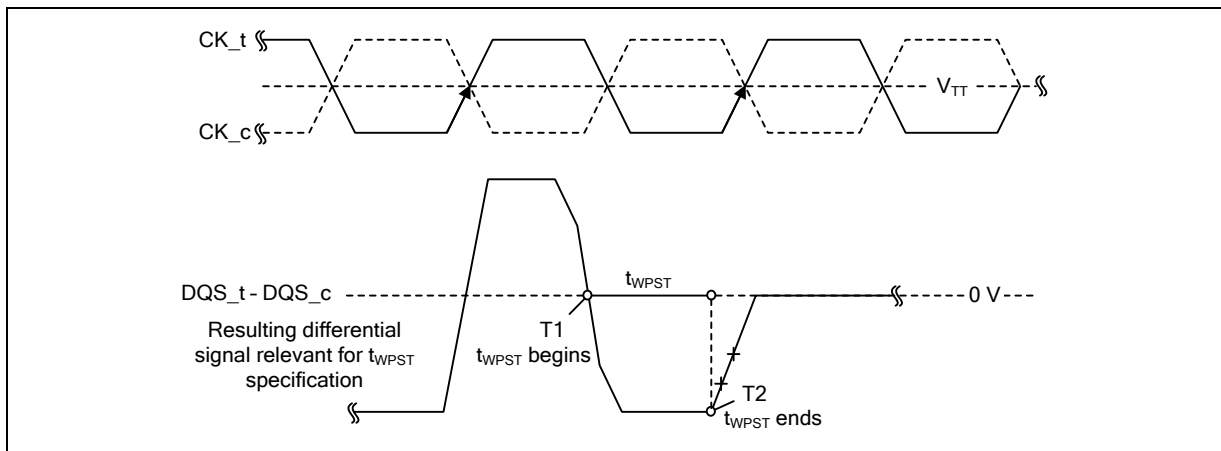

Figure 18 - Method for calculating t_{WPST} Transitions and Endpoints

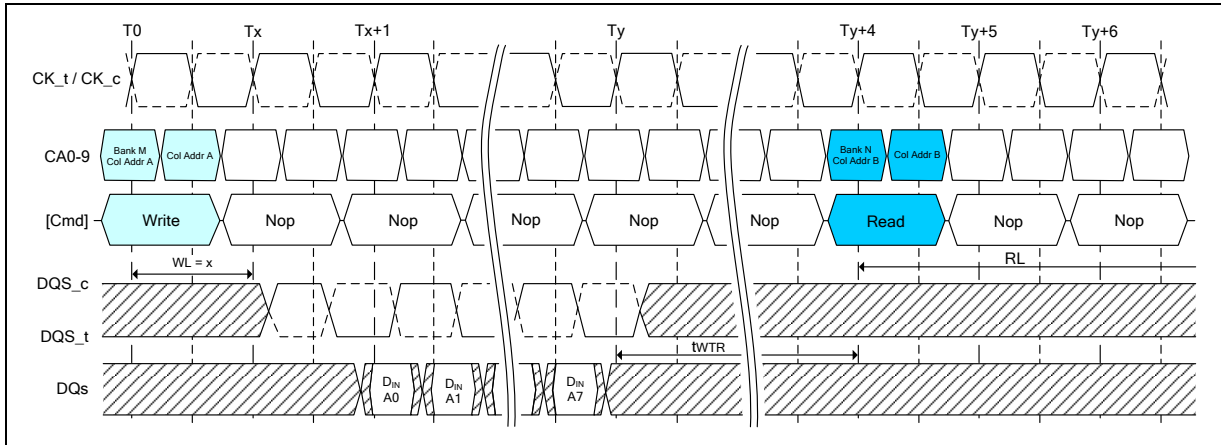

Figure 19 - Burst Write Followed By Burst Read

Notes:

1. The minimum number of clock cycles from the burst write command to the burst read command for any bank is $[WL + 1 + BL/2 + RU(tWTR/tCK)]$.
2. $tWTR$ starts at the rising edge of the clock after the last valid input data.

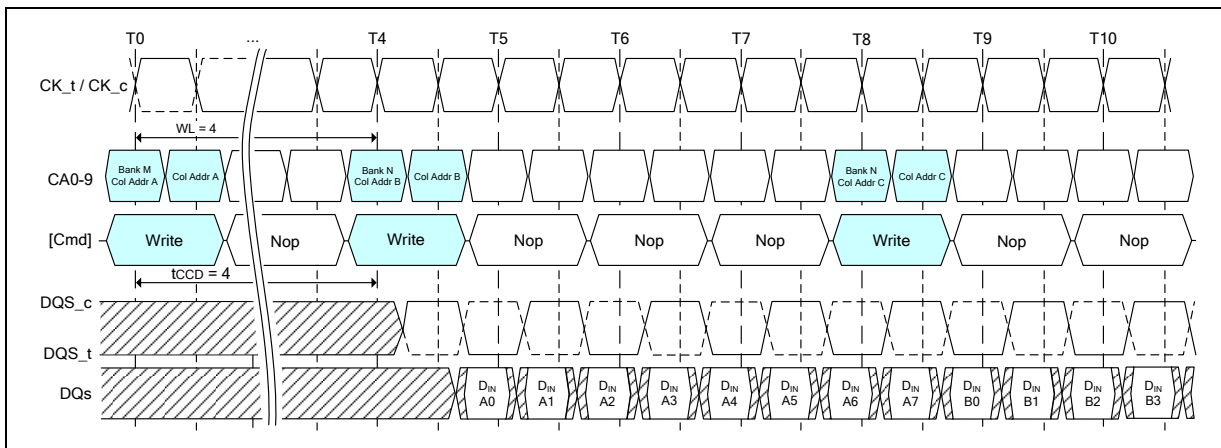

Figure 20 - Seamless burst write: WL = 4, tCCD = 4

Note:

1. The seamless burst write operation is supported by enabling a write command every four clocks for BL = 8 operation. This operation is allowed for any activated bank.



7.4.6 Write Data Mask

On LPDDR3 devices, one write data mask (DM) pin for each data byte (DQ) is supported, consistent with the implementation on LPDDR2 SDRAM. Each DM can mask its respective DQ for any given cycle of the burst. Data mask timings match data bit timing, but are inputs only. Internal data-mask loaded is identically to data-bit to ensure matched system timing.

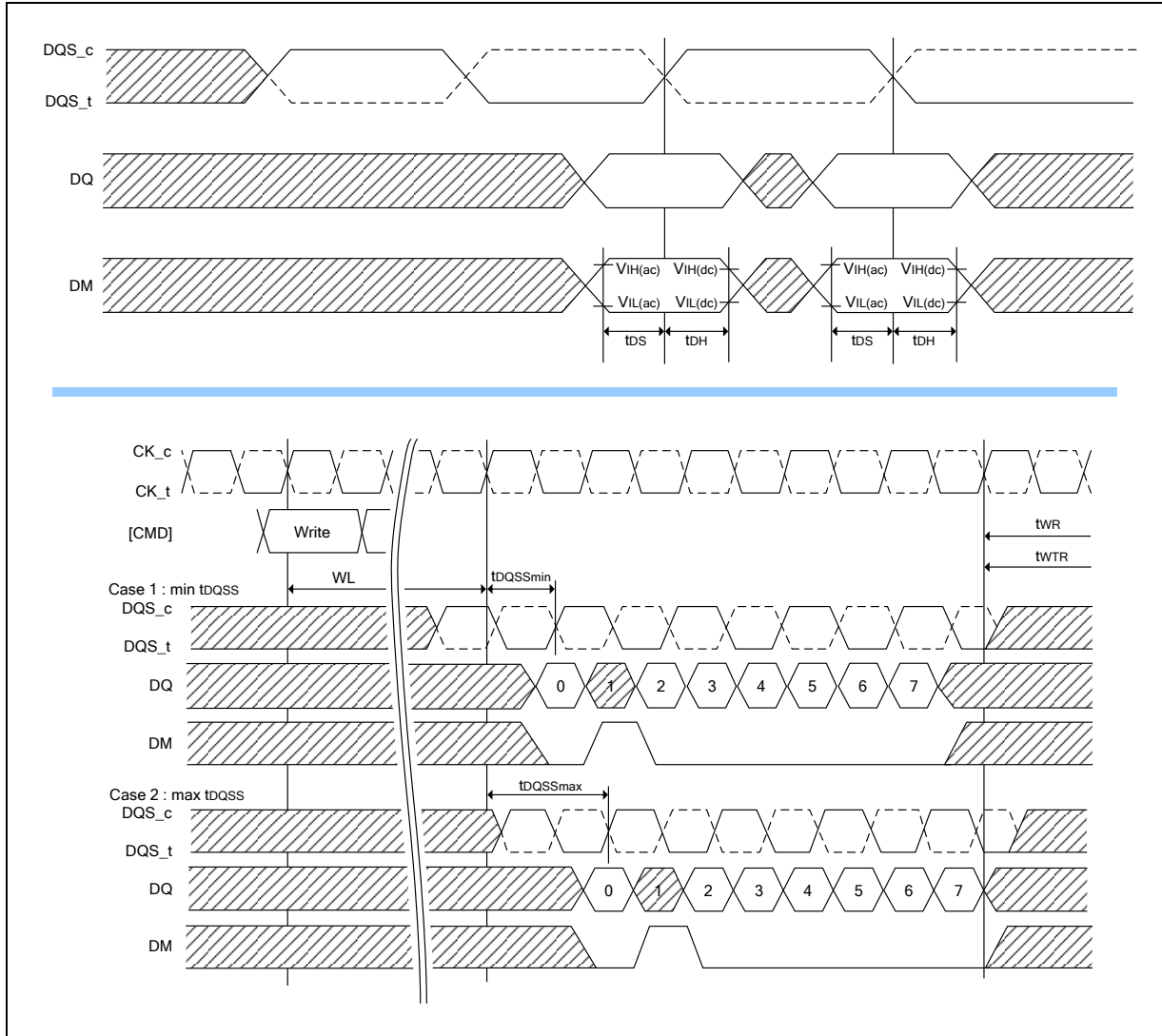

Figure 21 - Data Mask Timing

Note:

1. For the data mask function, BL = 8 is shown; the second data bit is masked.



7.4.7 Precharge Operation

The Precharge command is used to precharge or close a bank that has been activated. The Precharge command is initiated with CS_n LOW, CA0 HIGH, CA1 HIGH, CA2 LOW, and CA3 HIGH at the rising edge of the clock. The Precharge command can be used to precharge each bank independently or all banks simultaneously. The AB flag and the bank address bits, BA0, BA1, and BA2 are used to determine which bank(s) to precharge. The precharge bank(s) will be available for subsequent row access tRPab after an all-bank Precharge command is issued, or tRPpb after a single-bank Precharge command is issued.

To ensure that LPDDR3 devices can meet the instantaneous current demand required to operate, the row-precharge time for an all-bank Precharge (tRPab) will be longer than the row Precharge time for a single-bank Precharge (tRPpb). Activate to Precharge timing is shown in Figure 3.

Bank selection for Precharge by address bits

AB (CA4r)	BA2 (CA9r)	BA1 (CA8r)	BA0 (CA7r)	Precharged Bank(s)
0	0	0	0	Bank 0 only
0	0	0	1	Bank 1 only
0	0	1	0	Bank 2 only
0	0	1	1	Bank 3 only
0	1	0	0	Bank 4 only
0	1	0	1	Bank 5 only
0	1	1	0	Bank 6 only
0	1	1	1	Bank 7 only
1	DON'T CARE	DON'T CARE	DON'T CARE	All Banks

7.4.7.1 Burst Read Operation Followed by Precharge

For the earliest possible precharge, the Precharge command can be issued BL/2 clock cycles after a Read command. A new bank Active command can be issued to the same bank after the row Precharge time (tRP) has elapsed. A Precharge command cannot be issued until after tRAS is satisfied. The minimum Read-to-Precharge time must also satisfy a minimum analog time from the rising clock edge that initiates the last 8-bit prefetch of a Read command. tRTP begins BL/2 - 4 clock cycles after the Read command. For LPDDR3 Read-to-Precharge timings see section 7.4.8.3 “Precharge & Auto Precharge Clarification” table.

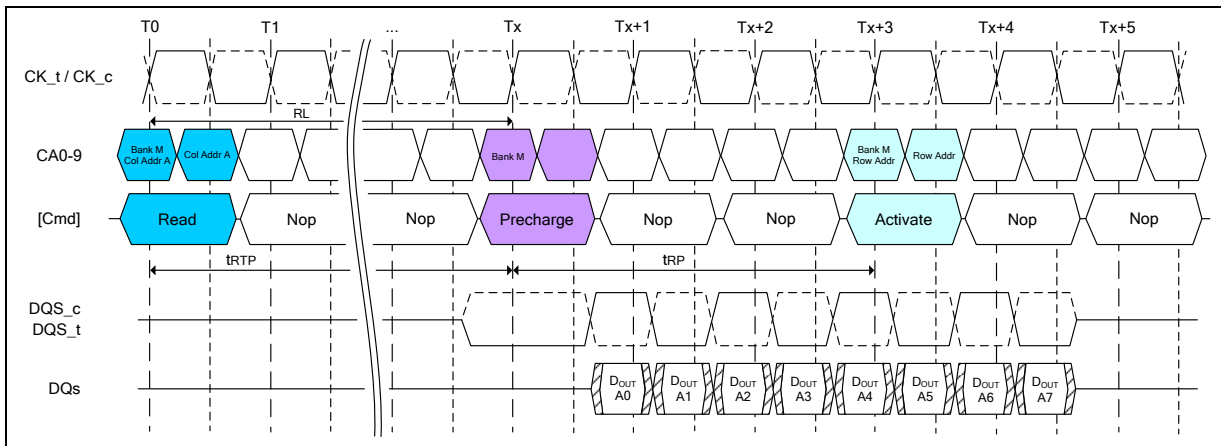

Figure 22 - Burst Read Followed by Precharge



7.4.7.2 Burst Write Followed by Precharge

For write cycles, a Write Recovery time (t_{WR}) must be provided before a Precharge command can be issued. This delay is referenced from the last valid burst input data to the completion of the burst Write. A Precharge command must not be issued prior to the t_{WR} delay. For LPDDR3 Write-to-Precharge timings see section 7.4.8.3 “Precharge & Auto Precharge Clarification” table.

LPDDR3 devices write data to the array in prefetch multiples (prefetch = 8). An internal write operation can only begin after a prefetch group has been completely latched, so t_{WR} starts at prefetch boundaries. The minimum Write-to-Precharge time for command to the same bank is $WL + BL/2 + 1 + RU(t_{WR}/t_{CK})$ clock cycles.

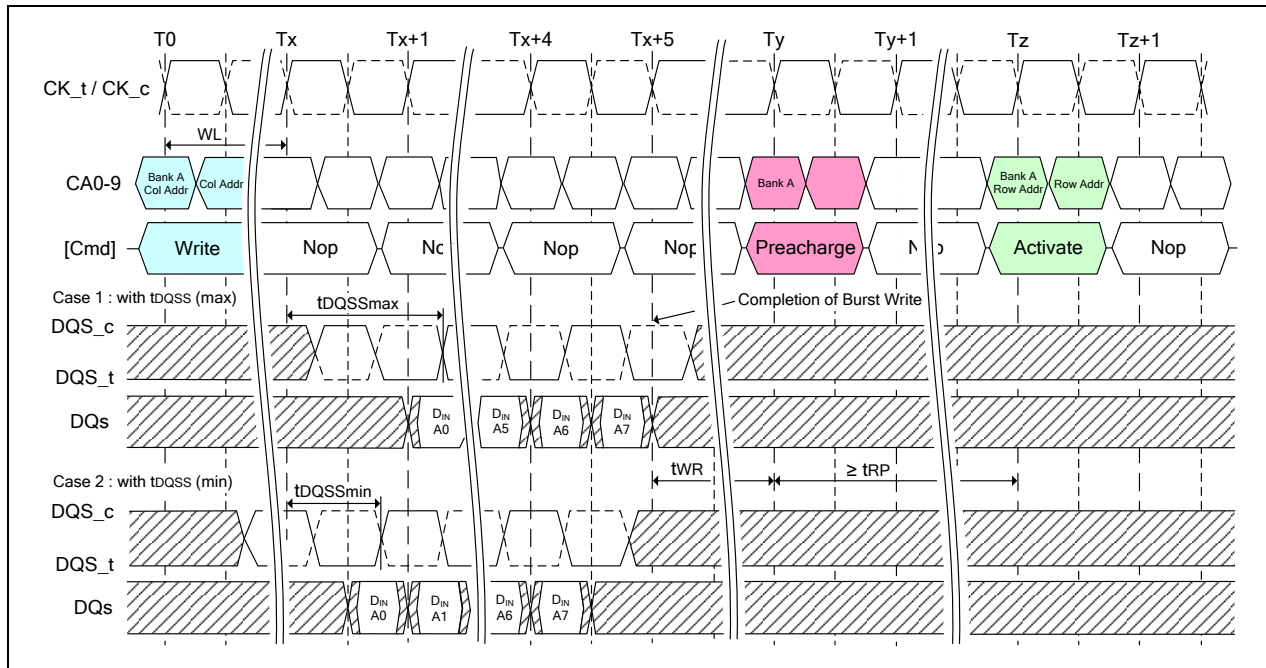

Figure 23 - Burst Write Followed by Precharge

7.4.8 Auto Precharge Operation

Before a new row can be opened in an active bank, the active bank must be precharged using either the Precharge command or the auto-precharge function. When a Read or a Write command is issued to the device, the AP bit (CA0f) can be set to enable the active bank to automatically begin precharge at the earliest possible moment during the burst read or write cycle.

If AP is LOW when the Read or Write command is issued, then normal Read or Write burst operation is executed and the bank remains active at the completion of the burst.

If AP is HIGH when the Read or Write command is issued, then the auto-precharge function is engaged. This feature enables the Precharge operation to be partially or completely hidden during burst read cycles (dependent upon Read or Write latency) thus improving system performance for random data access.



7.4.8.1 Burst Read with Auto-Precharge

If AP (CA0f) is HIGH when a Read command is issued, the Read with auto-precharge function is engaged. LPDDR3 devices start an auto-precharge operation on the rising edge of the clock BL/2 or BL/2 - 4 + RU(tRTP/tCK) clock cycles later than the Read with auto-precharge command, whichever is greater. For LPDDR3 auto-precharge calculations see section 7.4.8.3 “Precharge & Auto Precharge Clarification” table. Following an auto-precharge operation, an Activate command can be issued to the same bank if the following two conditions are satisfied simultaneously:

- a) The RAS precharge time (tRP) has been satisfied from the clock at which the auto-precharge begins.
- b) The RAS cycle time (tRC) from the previous bank activation has been satisfied.

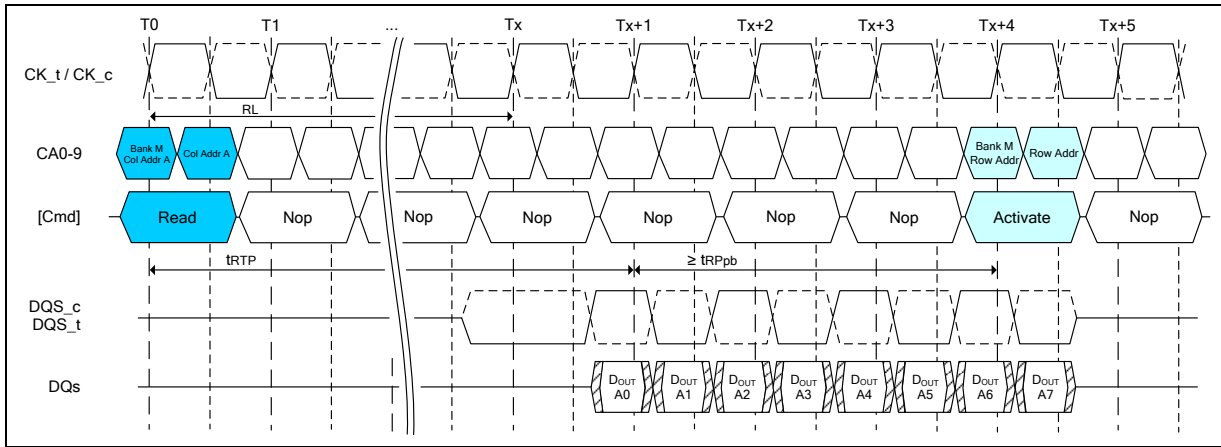

Figure 24 - Burst Read with Auto Precharge

7.4.8.2 Burst Write with Auto-Precharge

If AP (CA0f) is HIGH when a Write Command is issued, the Write with auto-precharge function is engaged. The device starts an auto-precharge on the rising edge tWR cycles after the completion of the burst write.

Following a Write with auto-precharge, an Activate command can be issued to the same bank if the following two conditions are met:

- The RAS precharge time (tRP) has been satisfied from the clock at which the auto-precharge begins.
- The RAS cycle time (tRC) from the previous bank activation has been satisfied.

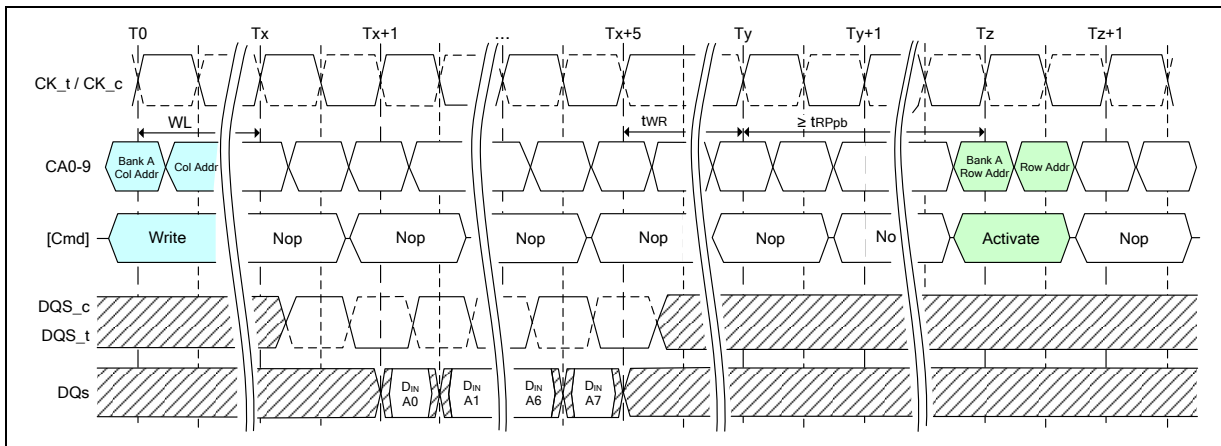

Figure 25 - Burst Write with Auto Precharge



7.4.8.3 Precharge & Auto Precharge Clarification

From Command	To Command	Minimum Delay between "From Command" to "To Command"	Unit	Notes
Read	Precharge (to same Bank as Read)	$BL/2 + \max(4, RU(tRTP/tCK)) - 4$	CLK	1
	Precharge All	$BL/2 + \max(4, RU(tRTP/tCK)) - 4$	CLK	1
Read w/AP	Precharge (to same Bank as Read w/AP)	$BL/2 + \max(4, RU(tRTP/tCK)) - 4$	CLK	1, 2
	Precharge All	$BL/2 + \max(4, RU(tRTP/tCK)) - 4$	CLK	1
	Activate (to same Bank as Read w/AP)	$BL/2 + \max(4, RU(tRTP/tCK)) - 4 + RU(tRPpb/tCK)$	CLK	1
	Write or Write w/AP (same bank)	Illegal	CLK	3
	Write or Write w/AP (different bank)	$RL + BL/2 + RU(tDQCK_{max}/tCK) - WL + 1$	CLK	3
	Read or Read w/AP (same bank)	Illegal	CLK	3
	Read or Read w/AP (different bank)	$BL/2$	CLK	3
Write	Precharge (to same Bank as Write)	$WL + BL/2 + RU(tWR/tCK) + 1$	CLK	1
	Precharge All	$WL + BL/2 + RU(tWR/tCK) + 1$	CLK	1
Write w/AP	Precharge (to same Bank as Write w/AP)	$WL + BL/2 + RU(tWR/tCK) + 1$	CLK	1
	Precharge All	$WL + BL/2 + RU(tWR/tCK) + 1$	CLK	1
	Activate (to same Bank as Write w/AP)	$WL + BL/2 + RU(tWR/tCK) + 1 + RU(tRPpb/tCK)$	CLK	1
	Write or Write w/AP (same bank)	Illegal	CLK	3
	Write or Write w/AP (different bank)	$BL/2$	CLK	3
	Read or Read w/AP (same bank)	Illegal	CLK	3
	Read or Read w/AP (different bank)	$WL + BL/2 + RU(tWTR/tCK) + 1$	CLK	3
Precharge	Precharge (to same Bank as Precharge)	1	CLK	1
	Precharge All	1	CLK	1
Precharge All	Precharge	1	CLK	1
	Precharge All	1	CLK	1

Notes:

- For a given bank, the precharge period should be counted from the latest precharge command, either one bank precharge or precharge all, issued to that bank. The precharge period is satisfied after tRP depending on the latest precharge command issued to that bank.
- Any command issued during the minimum delay time as specified in this table is illegal.
- After Read with AP, seamless read operations to different banks are supported. After Write with AP, seamless write operations to different banks are supported. Read and Write operations may not be interrupted or truncated.



7.4.9 Refresh command

The Refresh command is initiated with CS_n LOW, CA0 LOW, CA1 LOW, and CA2 HIGH at the rising edge of the clock. Per-bank Refresh is initiated with CA3 LOW at the rising edge of clock. All-bank Refresh is initiated with CA3 HIGH at the rising edge of clock.

A Per-bank Refresh command (REFpb) performs a per-bank refresh operation to the bank scheduled by the bank counter in the memory device. The bank sequence of per-bank Refresh is fixed to be a sequential round-robin:

“0-1-2-3-4-5-6-7-0-1-...”. The bank count is synchronized between the controller and the SDRAM by resetting the bank count to zero. Synchronization can occur upon issuing a RESET signal or at every exit from self refresh. Bank addressing for the per-bank Refresh count is the same as established for the single-bank Precharge command. A bank must be idle before it can be refreshed. The controller must track the bank being refreshed by the per-bank Refresh command.

The REFpb command must not be issued to the device until the following conditions are met (see 7.4.9.1 “**Refresh Command Scheduling Separation Requirements**” table):

- tRFCab has been satisfied after the prior REFab command
- tRFCpb has been satisfied after the prior REFpb command
- tRP has been satisfied after prior Precharge commands to that bank
- tRRD has been satisfied after the prior Activate command (if applicable, for example after activating a row in a different bank than the one affected by the REFpb command),

The target bank is inaccessible during per-bank Refresh cycle time (tRFCpb), however other banks within the device are accessible and can be addressed during the cycle. During the REFpb operation, any of the banks other than the one being refreshed can be maintained in active state or accessed by a Read or a Write command. When the per-bank Refresh cycle has completed, the affected bank will be in the idle state.

After issuing REFpb, these conditions must be met (see 7.4.9.1 “**Refresh Command Scheduling Separation Requirements**” table):

- tRFCpb must be satisfied before issuing a REFab command
- tRFCpb must be satisfied before issuing an Activate command to the same bank
- tRRD must be satisfied before issuing an Activate command to a different bank
- tRFCpb must be satisfied before issuing another REFpb command

An all-bank Refresh command (REFab) issues a Refresh command to all banks. All banks must be idle when REFab is issued (for instance, by issuing a Precharge-all command prior to issuing an all-bank Refresh command). REFab also synchronizes the bank count between the controller and the SDRAM to zero. The REFab command must not be issued to the device until the following conditions have been met (see 7.4.9.1 “**Refresh Command Scheduling Separation Requirements**” table):

- tRFCab has been satisfied following the prior REFab command
- tRFCpb has been satisfied following the prior REFpb command
- tRP has been satisfied following the prior Precharge commands

When the all-bank Refresh cycle has completed, all banks will be idle. After issuing REFab:

- tRFCab latency must be satisfied before issuing an Activate command
- tRFCab latency must be satisfied before issuing a REFab or REFpb command



7.4.9.1 Refresh Command Scheduling Separation Requirements

Symbol	Minimum Delay From...	To...	Note
tRFCab	REFab	REFab	
		Activate command to any bank	
		REFpb	
tRFCpb	REFpb	REFab	
		Activate command to same bank as REFpb	
		REFpb	
tRRD	REFpb	Activate command to different bank than REFpb	
	Activate	REFpb	1
		Activate command to different bank than prior Activate command	

Note:

1. A bank must be in the idle state before it is refreshed, so following an Activate command REFab is prohibited; REFpb is supported only if it affects a bank that is in the idle state.

In general, an all-bank Refresh command needs to be issued to the LPDDR3 SDRAM regularly every tREFI (or more precisely tREFIM = tREFI x RM, see MR4 setting) interval. To allow for improved efficiency in scheduling and switching between tasks, some flexibility in the absolute refresh interval is provided for postponing and pulling-in refresh command. A maximum of 8 Refresh commands can be postponed during operation of the LPDDR3 SDRAM, meaning that at no point in time more than a total of 8 Refresh commands are allowed to be postponed. In case that 8 Refresh commands are postponed in a row, the resulting maximum interval between the surrounding Refresh commands is limited to 9 x tREFI (9 x tREFIM = 9 x RM x tREFI). A maximum of 8 additional Refresh commands can be issued in advance (“pulled in”), with each one reducing the number of regular Refresh commands required later by one. Note that pulling in more than 8, depending on Refresh mode, Refresh commands in advance does not further reduce the number of regular Refresh commands required later, so that the resulting maximum interval between two surrounding Refresh commands is limited to 9 x tREFI (9 x tREFIM = 9 x RM x tREFI). At any given time, a maximum of 16 REF commands can be issued within 2 x tREFI (2 x tREFIM = 2 x RM x tREFI)

And for per-bank refresh, a maximum 8 x 8 per-bank Refresh commands can be postponed or pulled in for scheduling efficiency. At any given time, a maximum of 2 x 8 x 8 per-bank Refresh commands can be issued within 2 x tREFI (2 x RM x tREFI)

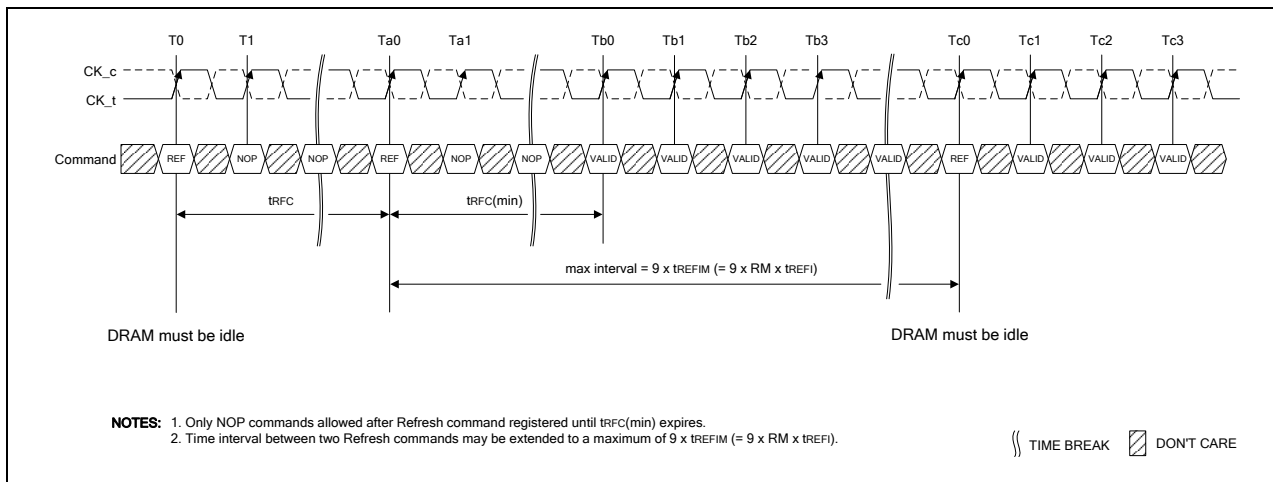

Figure 26 – Refresh Command Timing

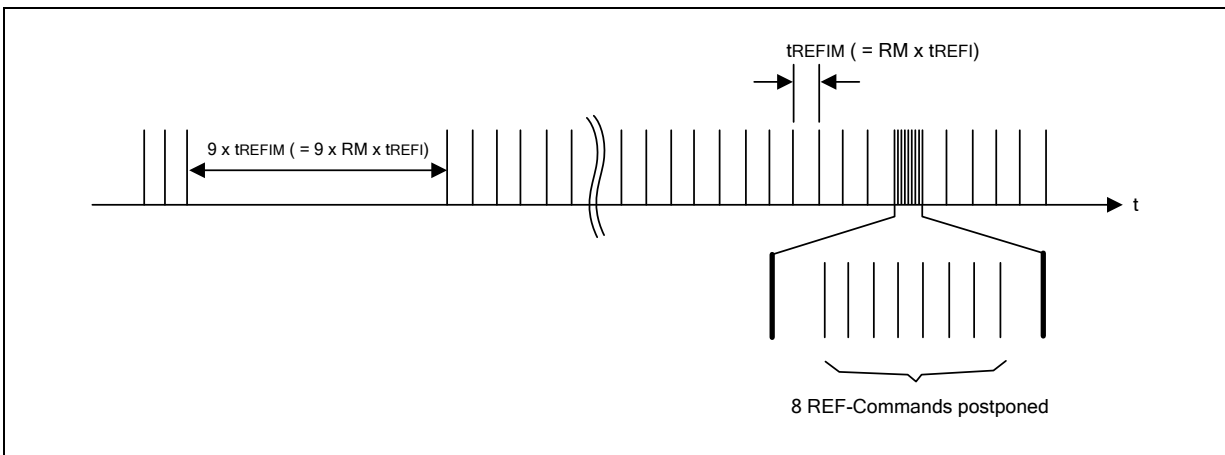

Figure 27 – Postponing Refresh Commands

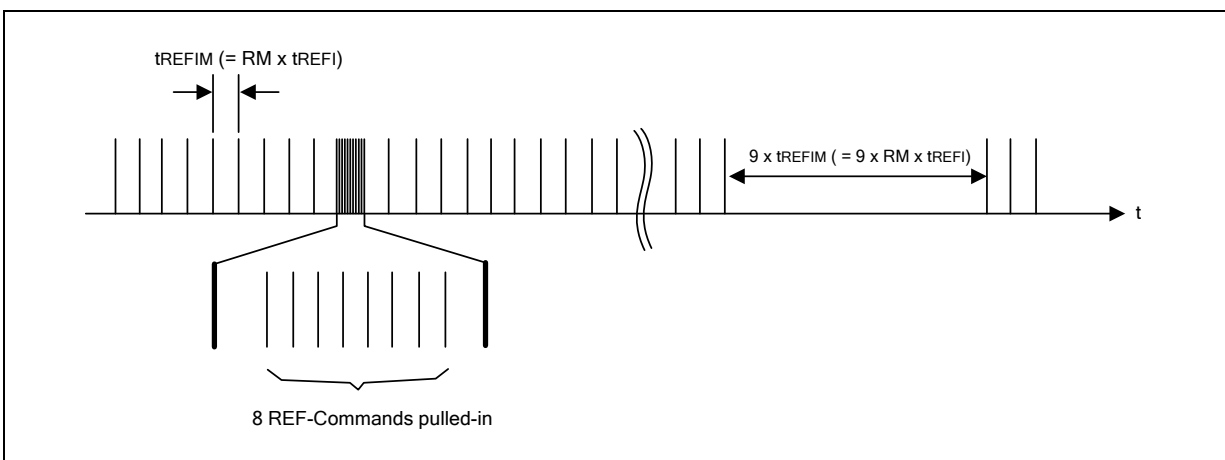

Figure 28 – Pulling-in Refresh Commands



7.4.9.2 Refresh Requirements

(1) Minimum number of Refresh commands:

LPDDR3 requires a minimum number of R Refresh (REFab) commands within any rolling refresh window ($t_{REFW} = 32 \text{ mS} @ \text{MR4}[2:0] = "011"$ or $\text{TCASE} @ 85^\circ\text{C}$). Based on the setting in MR4 a refresh multiplier RM larger or smaller than 1 may apply. The refresh window then becomes $t_{REFWM} = \text{RM} \times t_{REFW}$ and the refresh interval becomes $t_{REFIM} = \text{RM} \times t_{REFI}$, refer to MR4 definition for details.

When using per-bank Refresh, a REFab command can be replaced by a full cycle of eight REFpb commands.

(2) Refresh Requirements and Self-Refresh:

Self refresh mode may be entered with a maximum of eight refresh commands being postponed. After exiting self refresh mode with one or more refresh commands postponed, additional refresh commands may be postponed to the extent that the total number of postponed refresh commands (before and after the self refresh) will never exceed eight. During self-refresh mode, the number of postponed or pulled-in REF commands does not change."

"The use of self refresh mode introduces the possibility that an internally timed refresh event can be missed when CKE is raised for exit from self refresh mode. Upon exit from self refresh, the LPDDR3 SDRAM requires a minimum of one extra refresh command before it is put back into self refresh mode."

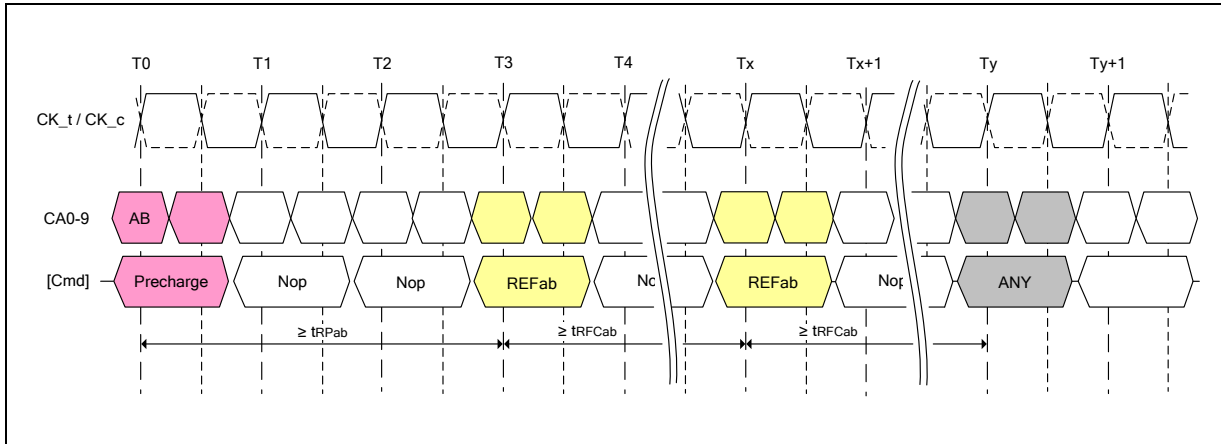

Figure 29 - All-Bank Refresh Operation

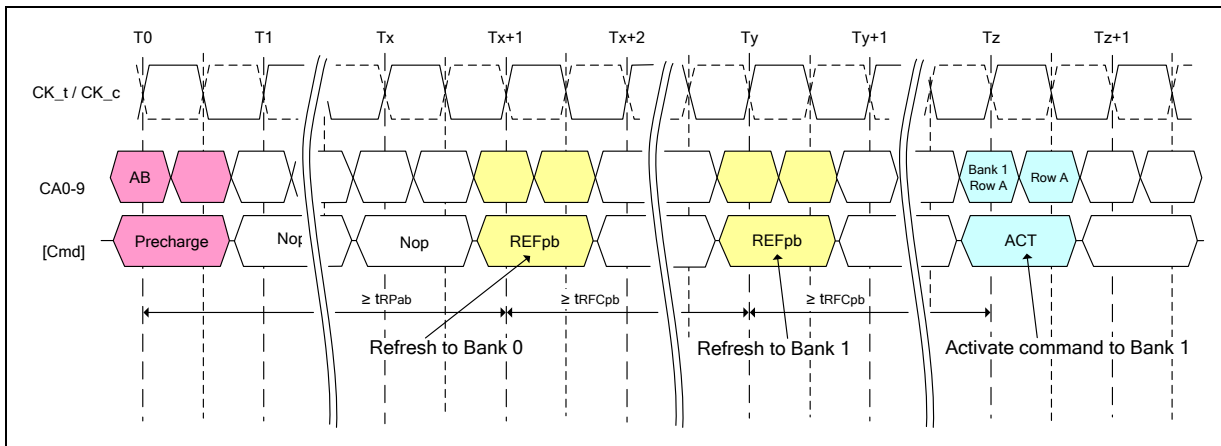

Figure 30 - Per-Bank Refresh Operation

Notes:

1. In the beginning of this example, the REFpb bank is pointing to bank 0.
2. Operations to banks other than the bank being refreshed are supported during the tRFCpb period.



7.4.10 Self Refresh Operation

The Self Refresh command can be used to retain data in the LPDDR3 SDRAM, even if the rest of the system is powered down. When in the Self Refresh mode, the SDRAM retains data without external clocking. The device has a built-in timer to accommodate Self Refresh operation. The Self Refresh command is defined by having CKE LOW, CS_n LOW, CA0 LOW, CA1 LOW, and CA2 HIGH at the rising edge of the clock. CKE must be HIGH during the previous clock cycle. CKE must not go LOW while MRR, MRW, Read, or Write operations are in progress. To ensure that there is enough time to account for internal delay on the CKE signal path, two NOP command are required after CKE is driven LOW, this timing period is defined as tCPDED. CKE LOW will result in deactivation of input receivers after tCPDED has expired. Once the command is registered, CKE must be held LOW to keep the device in Self Refresh mode.

LPDDR3 SDRAM devices can operate in Self Refresh in both the standard or extended temperature ranges. LPDDR3 devices will also manage Self Refresh power consumption when the operating temperature changes, lower at low temperatures and higher at high temperatures.

Once the SDRAM has entered Self Refresh mode, all of the external signals except CKE, are “don't care”. For proper self refresh operation, power supply pins (VDD1, VDD2, and VDDCA) must be at valid levels. VDDQ may be turned off during Self Refresh. Prior to exiting Self Refresh, VDDQ must be within specified limits. VREFDQ and VREFCA may be at any level within minimum and maximum levels (see **Absolute Maximum DC Ratings**). However prior to exiting Self Refresh, VREFDQ and VREFCA must be within specified limits (see **Recommended DC Operating Conditions**). The SDRAM initiates a minimum of one all-bank Refresh command internally within tCKESR period once it enters Self Refresh mode. The clock is internally disabled during Self Refresh operation to save power. The minimum time that the SDRAM must remain in Self Refresh mode is tCKESR,min. The user may change the external clock frequency or halt the external clock tCPDED after Self Refresh entry is registered; however, the clock must be restarted and stable before the device can exit Self Refresh operation.

The procedure for exiting Self Refresh requires a sequence of commands. First, the clock shall be stable and within specified limits for a minimum of 2 tCK prior to the positive clock edge that registers CKE HIGH. Once Self Refresh Exit is registered, a delay of at least tXSR must be satisfied before a valid command can be issued to the device to allow for any internal refresh in progress. CKE must remain HIGH for the entire Self Refresh exit period tXSR for proper operation. NOP commands must be registered on each positive clock edge during the Self Refresh exit interval tXSR. For the description of ODT operation and specifications during self-refresh entry and exit, see 7.4.14 “**On-Die Termination**” section.

The use of Self Refresh mode introduces the possibility that an internally timed refresh event can be missed when CKE is raised for exit from Self Refresh mode. Upon exit from Self Refresh, it is required that at least one Refresh command (8 per-bank or 1 all-bank) is issued before entry into a subsequent Self Refresh.

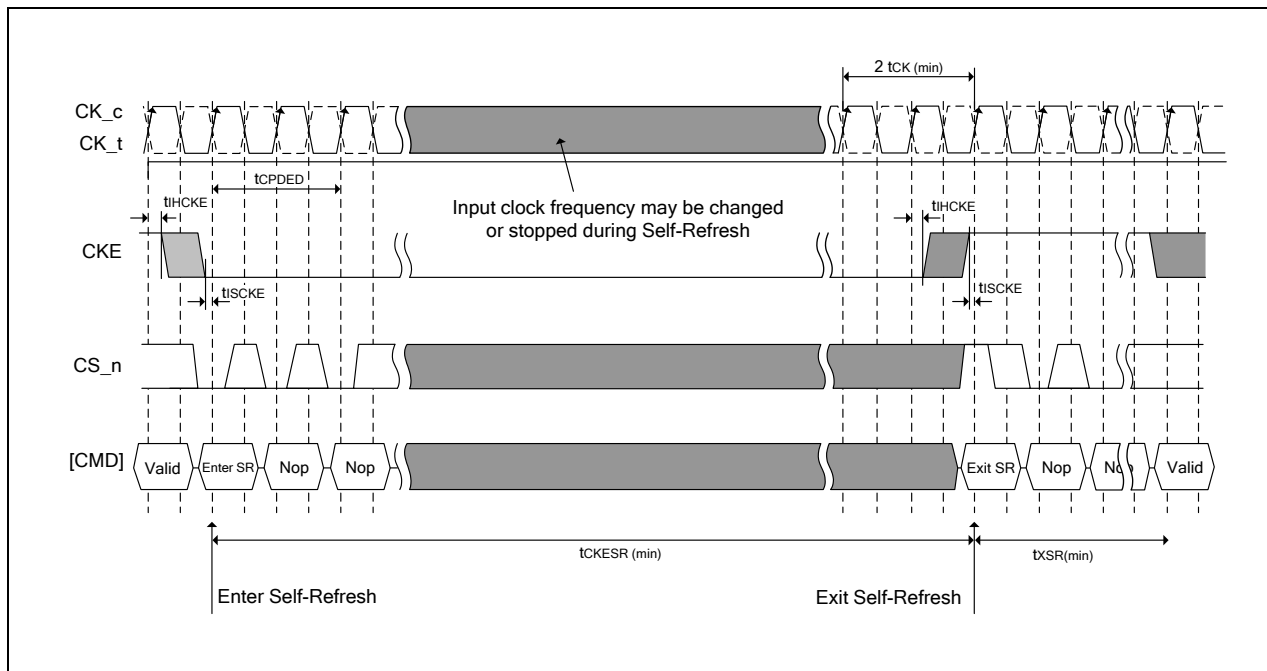

Figure 31 - Self-Refresh Operation

Notes:

1. Input clock frequency may be changed or can be stopped or floated during self-refresh, provided that upon exiting self-refresh, the clock is stable and within specified limits for a minimum of 2 clocks of stable clock are provided and the clock frequency is between the minimum and maximum frequency for the speed grade in use.
2. Device must be in the "All banks idle" state prior to entering Self Refresh mode.
3. tXSR begins at the rising edge of the clock after CKE is driven HIGH.
4. A valid command may be issued only after tXSR is satisfied. NOPs shall be issued during tXSR.



7.4.11 Partial Array Self-Refresh (PASR)

7.4.11.1 PASR Bank Masking

The LPDDR3 SDRAM has eight banks (additional banks may be required for higher densities). Each bank of an LPDDR3 SDRAM can be independently configured whether a self refresh operation is taking place. One mode register unit of 8 bits accessible via MRW command is assigned to program the bank masking status of each bank up to 8 banks. For bank masking bit assignments, see **MR16_PASR_Bank Mask (MA[7:0] = 10H)** PASR Bank Masking definitions table.

The mask bit to the bank controls a refresh operation of entire memory within the bank. If a bank is masked via MRW, a refresh operation to the entire bank is blocked and data retention by a bank is not guaranteed in self refresh mode. To enable a refresh operation to a bank, a coupled mask bit has to be programmed, “unmasked”. When a bank mask bit is unmasked, a refresh to a bank is determined by the programmed status of segment mask bits, which is described in the following section.

7.4.11.2 PASR Segment Masking

A segment masking scheme may be used in place of or in combination with bank masking scheme in LPDDR3 SDRAM. LPDDR3 devices utilize eight segments per bank. For segment masking bit assignments, see **MR17_PASR_Segment Mask (MA[7:0] = 11H)** PASR Segment Masking definitions table.

For those refresh-enabled banks, a refresh operation to the address range which is represented by a segment is blocked when the mask bit to this segment is programmed, “masked”. Programming of segment mask bits is similar to the one of bank mask bits. Eight segments are used as listed in **MR17_PASR_Segment Mask (MA[7:0] = 11H)** PASR Segment Masking definitions table. One mode register unit is used for the programming of segment mask bits up to 8 bits. One more mode register unit may be reserved for future use. Programming of bits in the reserved registers has no effect on the device operation.

Example of Bank and Segment Masking use in LPDDR3 devices

	Segment Mask(MR17)	Bank 0	Bank 1	Bank 2	Bank 3	Bank 4	Bank 5	Bank 6	Bank 7
BankMask (MR16)		0	1	0	0	0	0	0	1
Segment 0	0	-	M	-	-	-	-	-	M
Segment 1	0	-	M	-	-	-	-	-	M
Segment 2	1	M	M	M	M	M	M	M	M
Segment 3	0	-	M	-	-	-	-	-	M
Segment 4	0	-	M	-	-	-	-	-	M
Segment 5	0	-	M	-	-	-	-	-	M
Segment 6	0	-	M	-	-	-	-	-	M
Segment 7	1	M	M	M	M	M	M	M	M

Note:

This table illustrates an example of an 8-bank LPDDR3 device, when a refresh operation to bank 1 and bank 7, as well as segment 2 and segment 7 are masked



7.4.12 Mode Register Read (MRR) Command

The Mode Register Read (MRR) command is used to read configuration and status data from SDRAM mode registers. The MRR command is initiated with CS_n LOW, CA0 LOW, CA1 LOW, CA2 LOW, and CA3 HIGH at the rising edge of the clock. The mode register is selected by CA1f–CA0f and CA9r–CA4r. The mode register contents are available on the first data beat of DQ[7:0] after $RL \times tCK + tDQSCK + tDQSQ$ following the rising edge of the clock where MRR is issued. Subsequent data beats contain valid but undefined content, except in the case of the DQ calibration function, where subsequent data beats contain valid content as described in the DQ Calibration specification. All DQS are toggled for the duration of the mode register read burst.

The MRR command has a burst length of eight. MRR operation (consisting of the MRR command and the corresponding data traffic) must be interrupted. The MRR command period is tMRR.

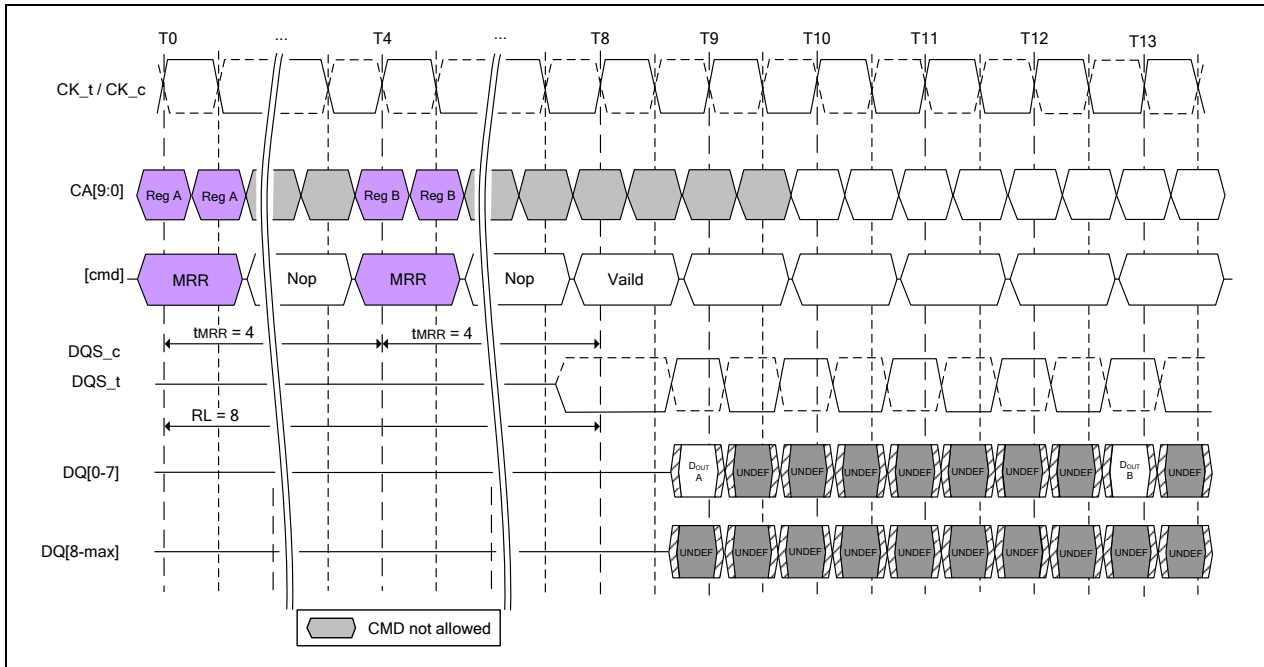

Figure 32 - Mode Register Read timing example: RL = 8

Notes:

1. MRRs to DQ calibration registers MR32 and MR40 are described in DQ calibration section.
2. Only the NOP command is supported during tMRR.
3. Mode register data is valid only on DQ[7:0] on the first beat. Subsequent beats contain valid but undefined data. DQ[MAX:8] contain valid but undefined data for the duration of the MRR burst.
4. Minimum Mode Register Read to write latency is $RL + RU(tDQSCK_{max}/tCK) + 8/2 + 1 - WL$ clock cycles.
5. Minimum Mode Register Read to Mode Register Write latency is $RL + RU(tDQSCK_{max}/tCK) + 8/2 + 1$ clock cycles.
6. In this example, RL = 8 for illustration purposes only.

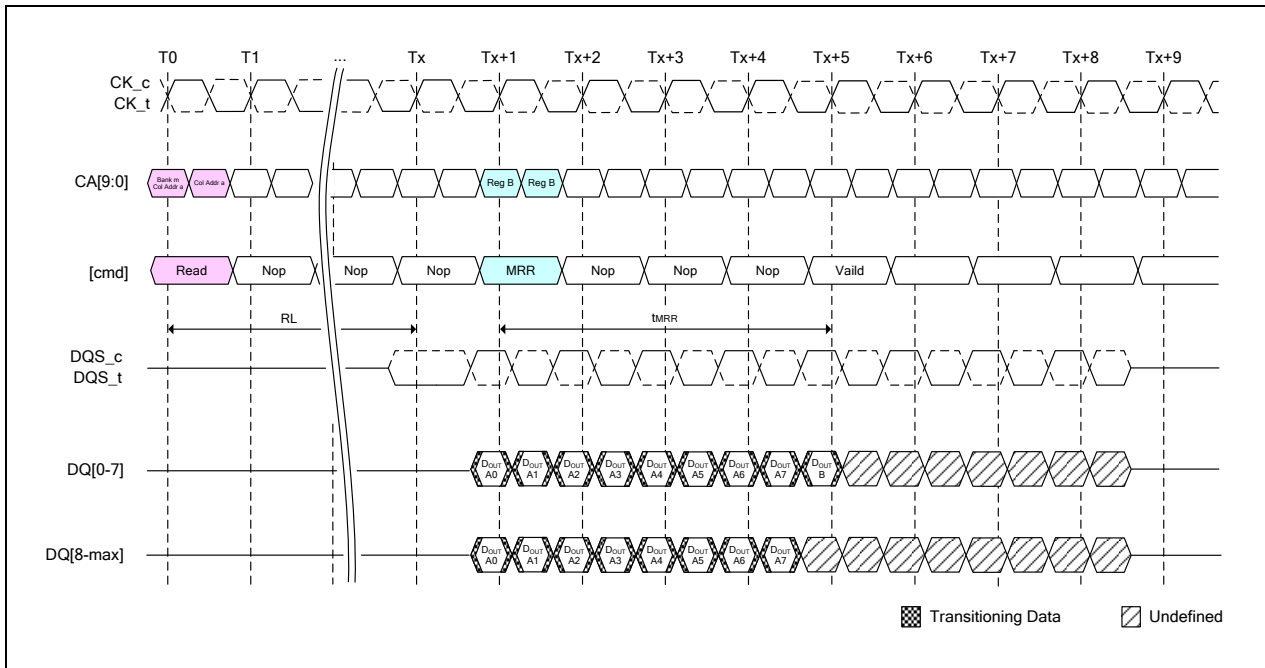

Figure 33 - Read to MRR Timing

Notes:

1. Only the NOP command is supported during tMRR.
2. The minimum number of clock cycles from the burst Read command to the MRR command is BL/2.

After a prior Read command, the MRR command must not be issued earlier than BL/2 clock cycles, or $WL + 1 + BL/2 + RU(tWTR/tCK)$ clock cycles after a prior Write command, as Read bursts and Write bursts must not be truncated by MRR.

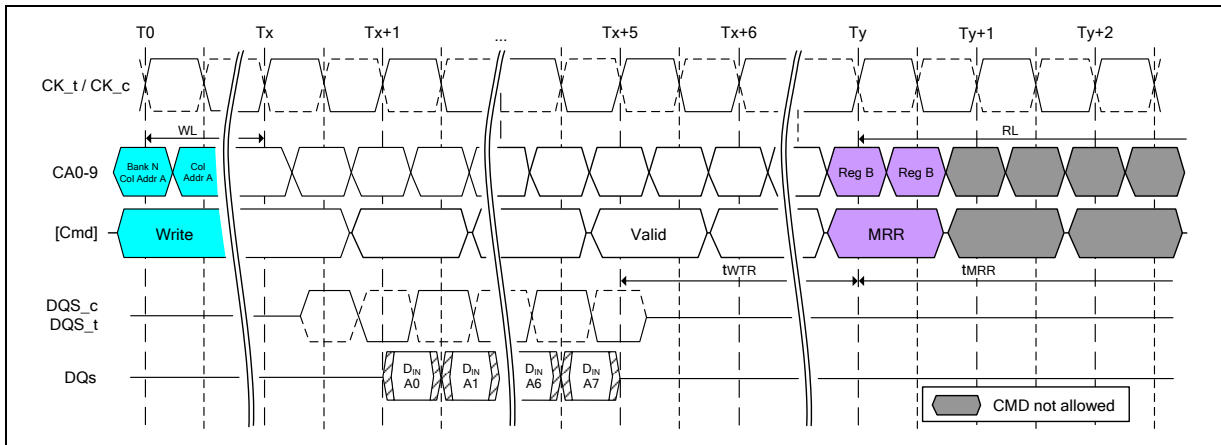

Figure 34 - Burst Write Followed by MRR

Notes:

1. The minimum number of clock cycles from the burst Write command to the MRR command is $[WL + 1 + BL/2 + RU(tWTR/tCK)]$.
2. Only the NOP command is supported during tMRR.



Following the idle power-down state, an additional time, t_{MRRI} , is required prior to issuing the mode register read (MRR) command. This additional time (equivalent to t_{RCD}) is required in order to be able to maximize power-down current savings by allowing more power-up time for the MRR data path after exit from standby, idle power-down mode.

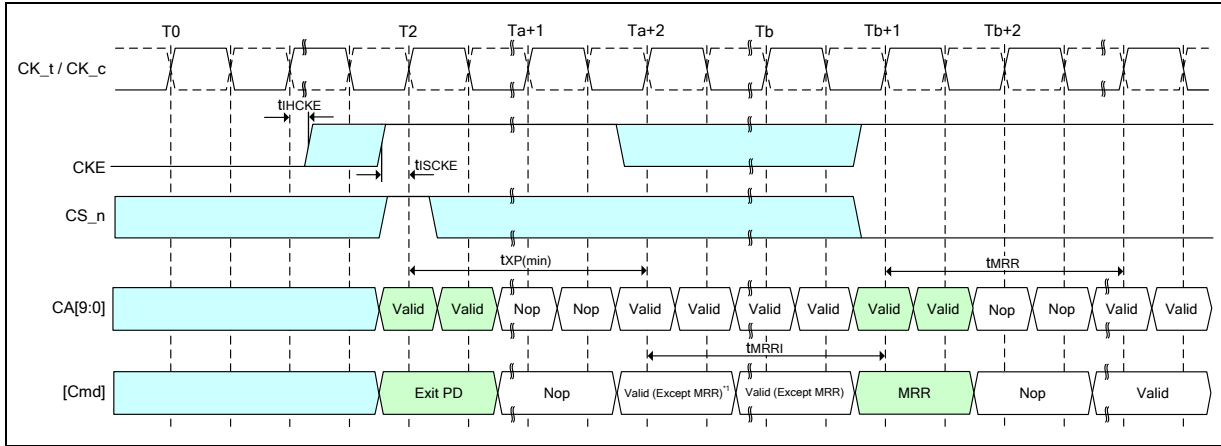

Figure 35 - MRR Following Power-Down Idle State

Notes:

1. Any valid command from the idle state except MRR.
2. $t_{MRRi} = t_{RCD}$.



7.4.12.1 Temperature Sensor

LPDDR3 SDRAM features a temperature sensor whose status can be read from MR4. This sensor can be used to determine an appropriate refresh rate, determine whether AC timing de-rating is required in the extended temperature range and/or monitor the operating temperature. Either the temperature sensor or the device operating temperature (See 8.2.3 “**Operating Temperature Range**” table) may be used to determine whether operating temperature requirements are being met.

LPDDR3 devices shall monitor device temperature and update MR4 according to tTSI. Upon exiting self-refresh or power-down, the device temperature status bits shall be no older than tTSI.

When using the temperature sensor, the actual device case temperature may be higher than the operating temperature specification (See 8.2.3 “**Operating Temperature Range**” table) that applies for the standard or extended temperature ranges. For example, TCASE may be above 85°C when MR4[2:0] equals 011b. LPDDR3 devices shall allow for 2°C temperature margin between the point at which the device updates the MR4 value and the point at which the controller re-configures the system accordingly. In the case of tight thermal coupling of the memory device to external hot spots, the maximum device temperature might be higher than what is indicated by MR4.

To assure proper operation using the temperature sensor, applications should consider the following factors:

- TempGradient is the maximum temperature gradient experienced by the memory device at the temperature of interest over a range of 2°C.
- ReadInterval is the time period between MR4 reads from the system.
- TempSensorInterval (tTSI) is maximum delay between internal updates of MR4.
- SysRespDelay is the maximum time between a read of MR4 and the response by the system.

In order to determine the required frequency of polling MR4, the system shall use the maximum TempGradient and the maximum response time of the system using the following equation:

$$\text{TempGradient} \times (\text{ReadInterval} + \text{tTSI} + \text{SysRespDelay}) \leq 2^\circ\text{C}$$

Table of Temperature Sensor

Parameter	Symbol	Max/Min	Value	Unit
System Temperature Gradient	TempGradient	Max	System Dependent	°C/S
MR4 Read Interval	ReadInterval	Max	System Dependent	mS
Temperature Sensor Interval	tTSI	Max	32	mS
System Response Delay	SysRespDelay	Max	System Dependent	mS
Device Temperature Margin	TempMargin	Max	2	°C

For example, if TempGradient is 10°C/S and the SysRespDelay is 1 mS:

$$10^\circ\text{C/S} \times (\text{ReadInterval} + 32\text{mS} + 1\text{mS}) \leq 2^\circ\text{C}$$

In this case, ReadInterval shall be no greater than 167 mS.

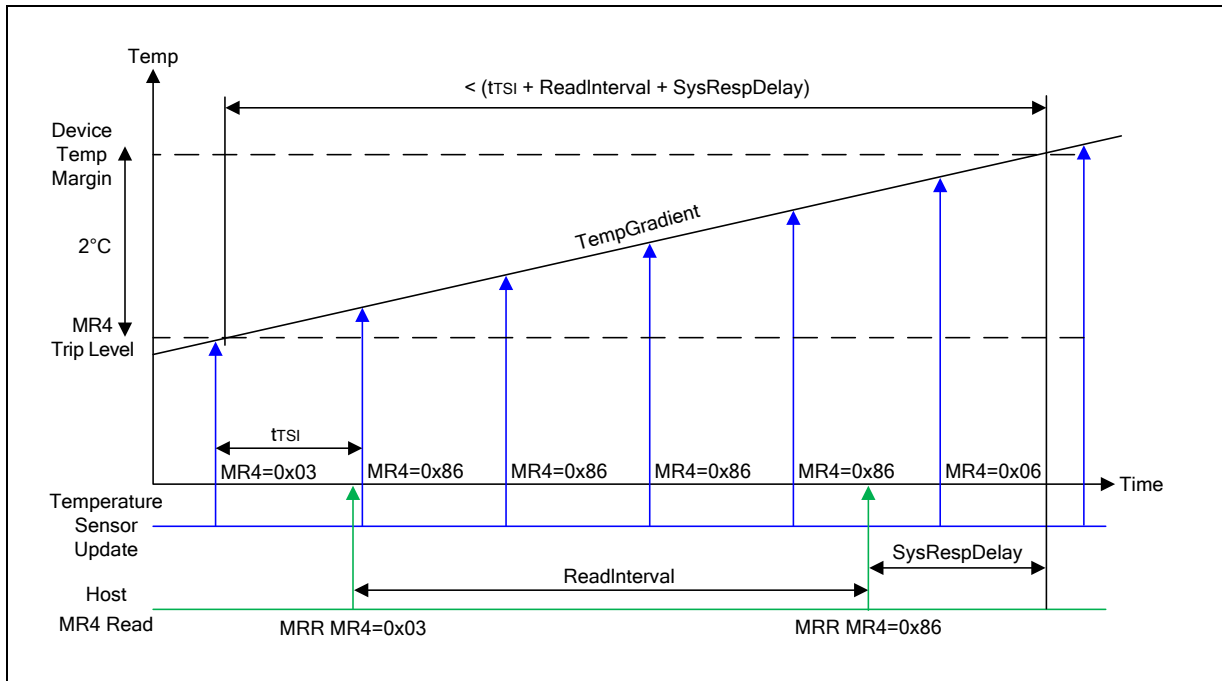

Figure 36 - Temperature Sensor Timing

7.4.12.2 DQ Calibration

LPDDR3 device features a DQ Calibration function that outputs one of two predefined system timing calibration patterns. A Mode Register Read to MR32 (Pattern “A”) or MR40 (Pattern “B”) will return the specified pattern on DQ[0] and DQ[8] for x16 devices, and DQ[0], DQ[8], DQ[16], and DQ[24] for x32 devices.

For x16 devices, DQ[7:1] and DQ[15:9] are showed the same information as DQ[0].

For x32 devices, DQ[7:1], DQ[15:9], DQ[23:17], and DQ[31:25] are showed the same information as DQ[0].

Table of Data Calibration Pattern Description

Pattern	Bit Time 0	Bit Time 1	Bit Time 2	Bit Time 3	Bit Time 4	Bit Time 5	Bit Time 6	Bit Time 7
Pattern “A” (MR32)	1	0	1	0	1	0	1	0
Pattern “B” (MR40)	0	0	1	1	0	0	1	1

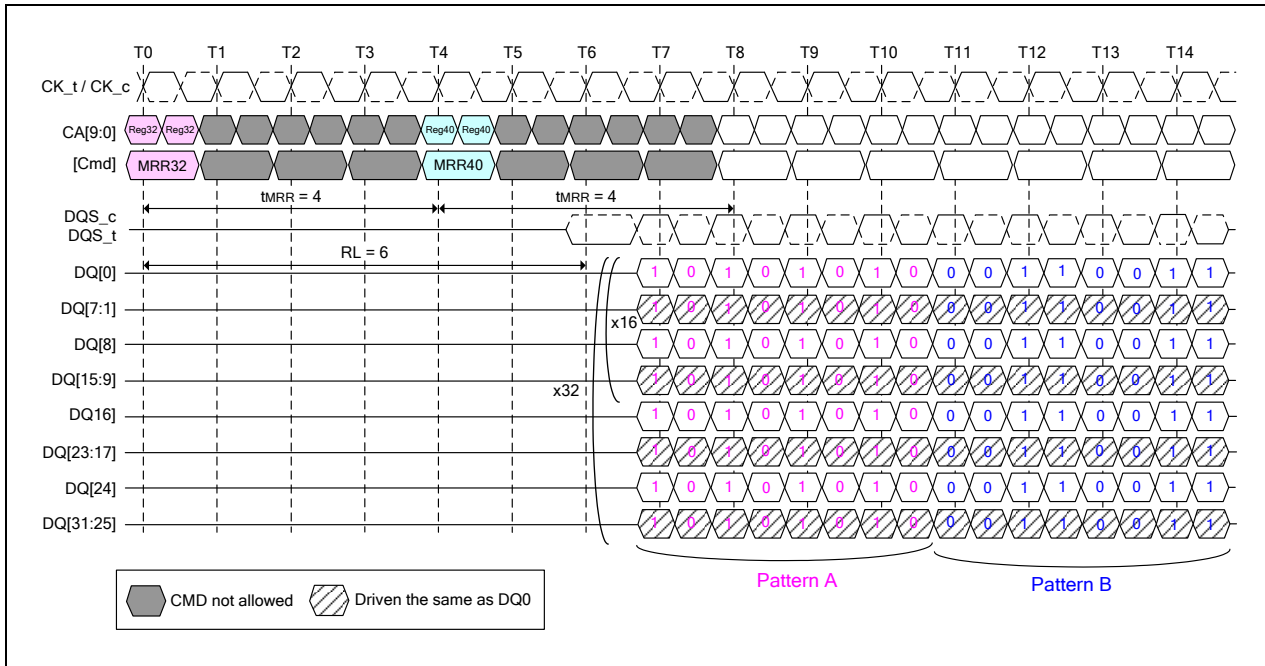

Figure 37 - DQ Calibration Timing

7.4.13 Mode Register Write (MRW) Command

The Mode Register Write (MRW) command is used to write configuration data to mode registers. The MRW command is initiated by having CS_n LOW, CA0 LOW, CA1 LOW, CA2 LOW, and CA3 LOW at the rising edge of the clock. The mode register is selected by CA1f-CA0f, CA9r-CA4r. The data to be written to the mode register is contained in CA9f-CA2f. The MRW command period is defined by tMRW. Mode Register Writes to read-only registers have no impact on the functionality of the device.

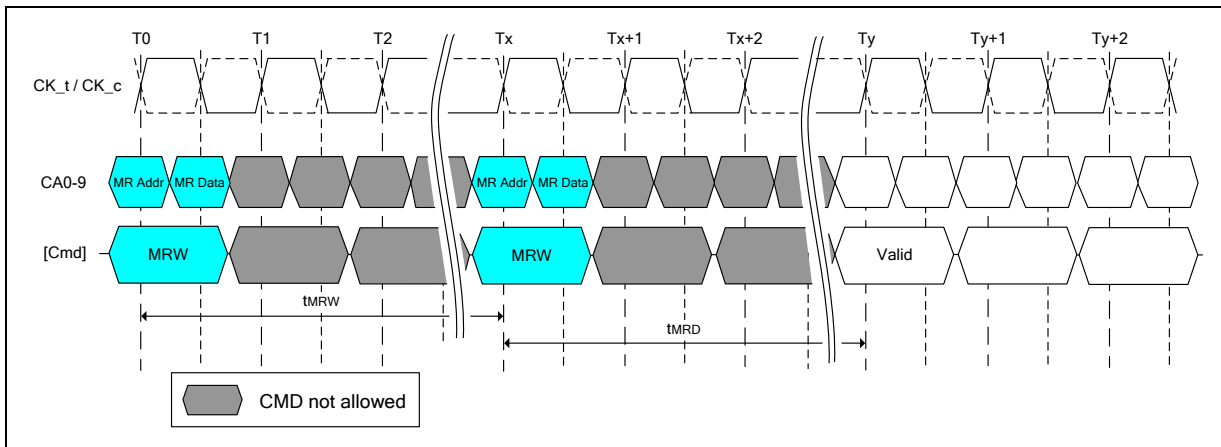

Figure 38 - Mode Register Write Timing

Notes:

1. At time Ty, the device is in the idle state.
2. Only the NOP command is supported during tMRW.



7.4.13.1 Mode Register Write

MRW can only be issued when all banks are in the idle precharge state. One method of ensuring that the banks are in this state is to issue a Precharge-All command.

7.4.13.1.1 MRW RESET

The MRW RESET command brings the device to the device auto-initialization (resetting) state in the power-on initialization sequence. The MRW RESET command can be issued from the idle state. This command resets all mode registers to their default values. After MRW RESET, boot timings must be observed until the device initialization sequence is complete and the device is in the idle state. Array data is undefined after the MRW RESET command.

If the initialization is to be performed at-speed (greater than the recommended boot clock frequency), then CA Training may be necessary to ensure setup and hold timings. Since the MRW RESET command is required prior to CA Training it may be difficult to meet setup and hold requirements. User may however choose the OP code 0xFCh. This encoding ensures that no transitions are required on the CA bus between rising and falling clock edge. Prior to CA Training, it is recommended to hold the CA bus stable for one cycle prior to, and one cycle after, the issuance of the MRW RESET command to ensure setup and hold timings on the CA bus.

Truth Table for Mode Register Read (MRR) and Mode Register Write (MRW)

Current State	Command	Intermediate State	Next State
All Banks Idle	MRR	Mode Register Reading (All Banks Idle)	All Banks Idle
	MRW	Mode Register Writing (All Banks Idle)	All Banks Idle
	MRW (RESET)	Resetting (Device Auto-Initialization)	All Banks Idle
Bank(s) Active	MRR	Mode Register Reading (Bank(s) Active)	Bank(s) Active
	MRW	Not Allowed	Not Allowed
	MRW (RESET)	Not Allowed	Not Allowed

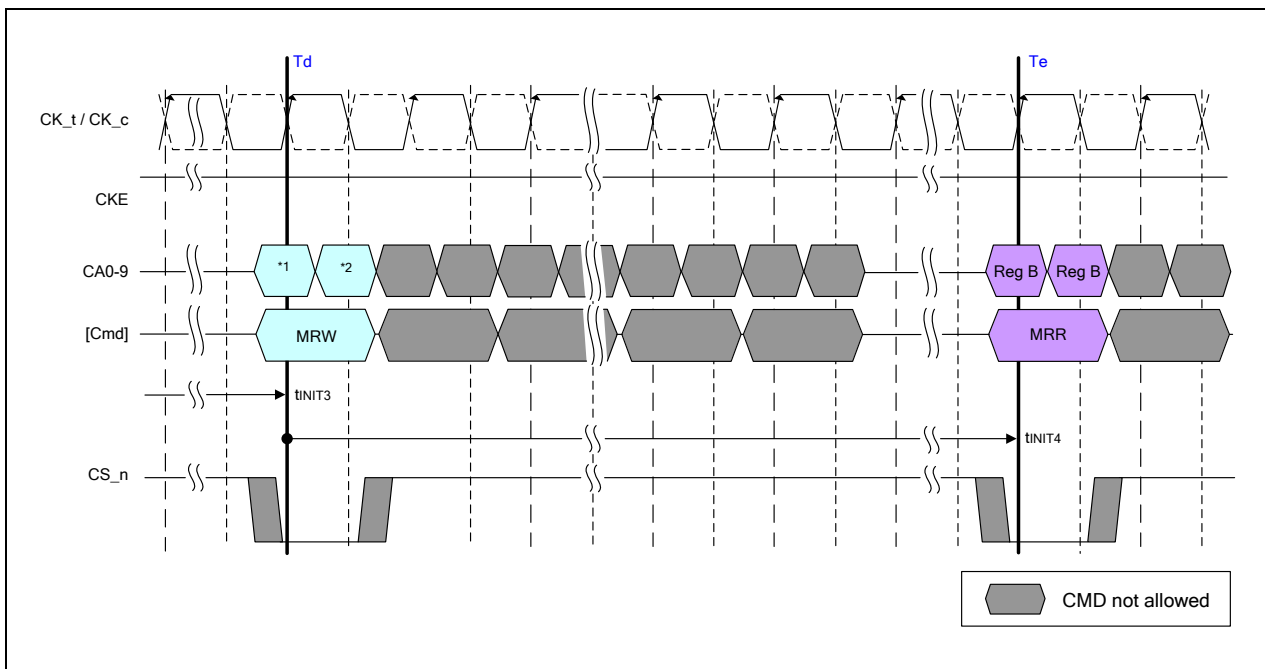

Figure 39 - Mode Register Write Timing for MRW RESET

Notes:

1. CA [9:0] = 3F0h.
2. CA [9:0] = 3F0h or xxxh.



7.4.13.2 Mode Register Write ZQ Calibration Command

The MRW command is used to initiate the ZQ Calibration command. This command is used to calibrate the output driver impedance and on-die termination across process, temperature, and voltage. LPDDR3 devices support ZQ calibration.

There are four ZQ calibration commands and related timings times, tZQINIT, tZQRESET, tZQCL, and tZQCS. tZQINIT is for initialization calibration, tZQRESET is for resetting ZQ to the default output impedance, tZQCL is for long calibration(s), and tZQCS is for short calibration(s).

The Initialization ZQ calibration (ZQINIT) must be performed for LPDDR3. ZQINIT provides an output impedance accuracy of $\pm 15\%$. After initialization, the ZQ Calibration Long (ZQCL) can be used to re-calibrate the system to an output impedance accuracy of $\pm 15\%$. A ZQ Calibration Short (ZQCS) can be used periodically to compensate for temperature and voltage drift in the system. The ZQ Reset command (ZQRESET) resets the output impedance calibration to a default accuracy of $\pm 30\%$ across process, voltage, and temperature. This command is used to ensure output impedance accuracy to $\pm 30\%$ when ZQCS and ZQCL commands are not used.

One ZQCS command can effectively correct at least 1.5% (ZQCorrection) of output impedance error within tZQCS for all speed bins, assuming the maximum sensitivities specified are met. The appropriate interval between ZQCS commands can be determined from using these tables and system-specific parameters.

LPDDR3 devices are subject to temperature drift rate (Tdriftrate) and voltage drift rate (Vdriftrate) in various applications. To accommodate drift rates and calculate the necessary interval ZQCS command, apply the following formula:

$$\frac{ZQCorrection}{(TSens \times Tdriftrate) + (VSens \times Vdriftrate)} = CalibrationInterval$$

where TSens = max(dRONdT) and VSens = max(dRONdV) define temperature and voltage sensitivities.

For example, if TSens = 0.75% / °C, VSens = 0.20% / mV, Tdriftrate = 1°C / sec and Vdriftrate = 15 mV / sec, then the interval between ZQCS commands is calculated as:

$$\frac{1.5}{(0.75 \times 1) + (0.20 \times 15)} = 0.4s$$

A ZQ Calibration command can only be issued when the device is in idle state with all banks precharged. ODT shall be disabled via the mode register or the ODT pin prior to issuing a ZQ calibration command. No other activities can be performed on the data bus and the data bus shall be un-terminated during the calibration period (tZQINIT, tZQCL, or tZQCS). The quiet time on the data bus helps to accurately calibrate output impedance. There is no required quiet time after the ZQRESET command. If multiple devices share a single ZQ resistor, only one device can be calibrating at any given time. After calibration is complete, the ZQ pin circuitry is disabled to reduce power consumption. In systems sharing a ZQ resistor between devices, the controller must prevent tZQINIT, tZQCS, and tZQCL overlap between the devices. ZQRESET overlap is acceptable.

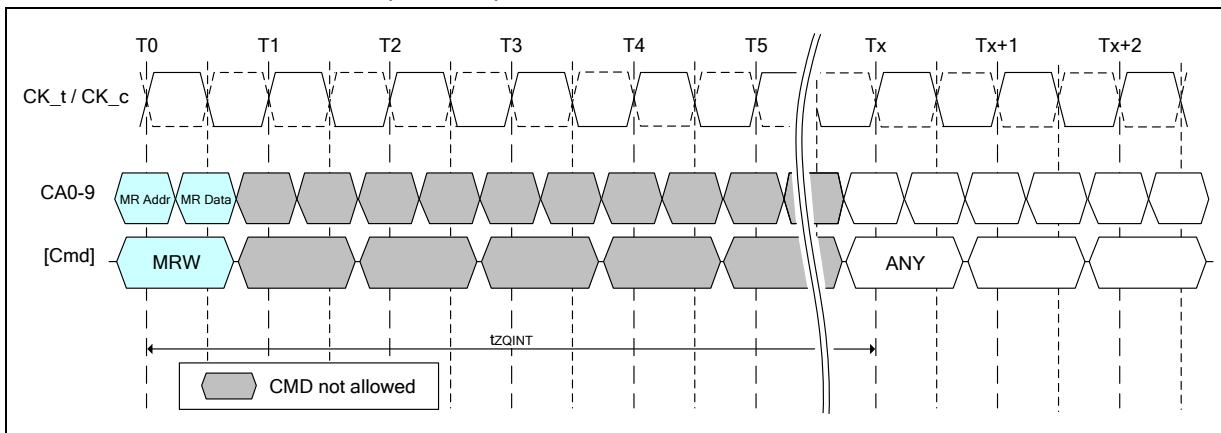

Figure 40 - ZQ Initialization Timing

Notes:

1. Only the NOP command is supported during ZQ calibration.
2. CKE must be registered HIGH continuously during the calibration period.
3. All devices connected to the DQ bus should be High-Z during the calibration process.

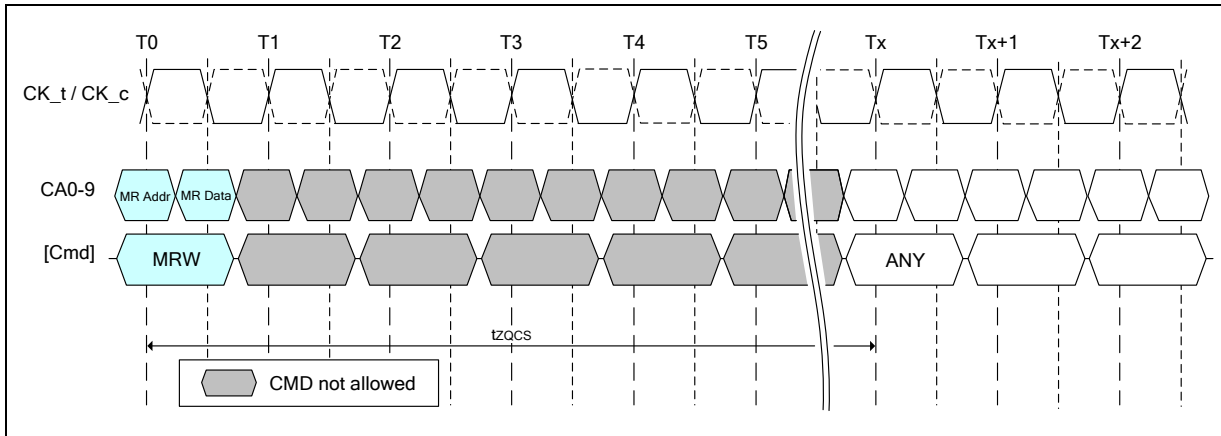

Figure 41 - ZQ Calibration Short Timing

Notes:

1. Only the NOP command is supported during ZQ calibration.
2. CKE must be registered HIGH continuously during the calibration period.
3. All devices connected to the DQ bus should be High-Z during the calibration process.

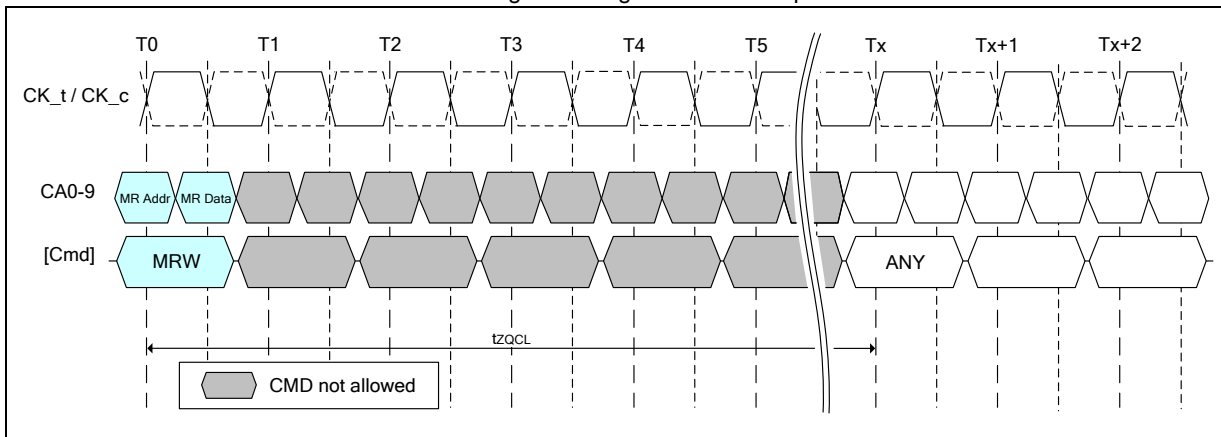

Figure 42 - ZQ Calibration Long Timing

Notes:

1. Only the NOP command is supported during ZQ calibration.
2. CKE must be registered HIGH continuously during the calibration period.
3. All devices connected to the DQ bus should be High-Z during the calibration process.

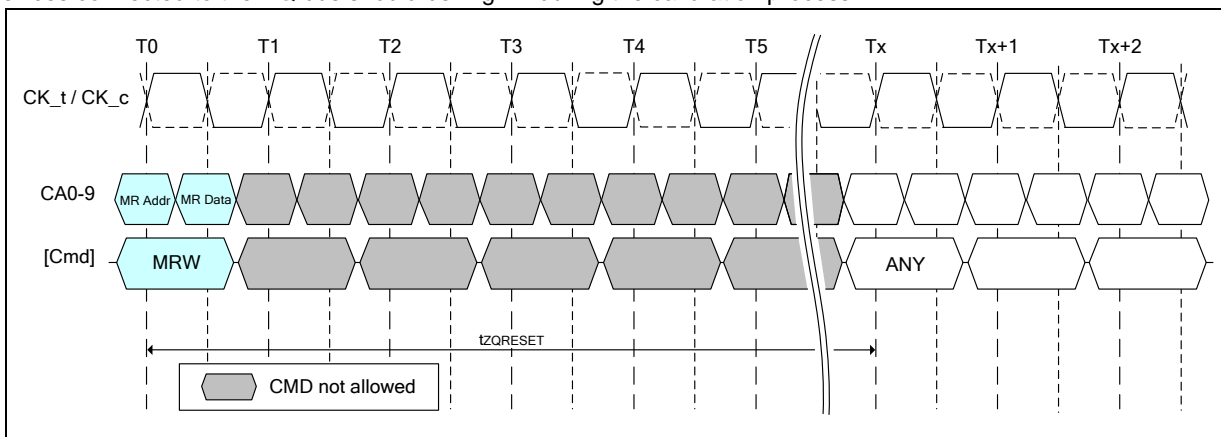

Figure 43 - ZQ Calibration Reset Timing

Notes:

1. Only the NOP command is supported during ZQ calibration.
2. CKE must be registered HIGH continuously during the calibration period.
3. All devices connected to the DQ bus should be High-Z during the calibration process.



7.4.13.2.1 ZQ External Resistor Value, Tolerance, and Capacitive Loading

To use the ZQ Calibration function, a $RZQ \pm 1\%$ tolerance external resistor must be connected between the ZQ pin and ground. A single resistor can be used for each device or one resistor can be shared between multiple devices if the ZQ calibration timings for each device do not overlap. The total capacitive loading on the ZQ pin must be limited (See section 8.3 “Input/Output Capacitance” table).

7.4.13.3 Mode Register Write – CA Training Mode

Because CA inputs operate as double data rate, it may be difficult for memory controller to satisfy CA input setup/hold timings at higher frequency. A CA Training mechanism is provided.

7.4.13.3.1 CA Training Sequence

- a) CA Training mode entry: Mode Register Write to MR41
- b) CA training session: Calibrate CA0, CA1, CA2, CA3, CA5, CA6, CA7 and CA8 (see the CA to DQ mapping (CA Training mode enabled with MR41) table in next page)
- c) CA to DQ mapping change: Mode register Write to MR48
- d) Additional CA Training session: Calibrate remaining CA pins (CA4 and CA9) (see the CA to DQ mapping (CA Training mode is enabled with MR48) table in next page)
- e) CA Training mode exit: Mode register Write to MR42

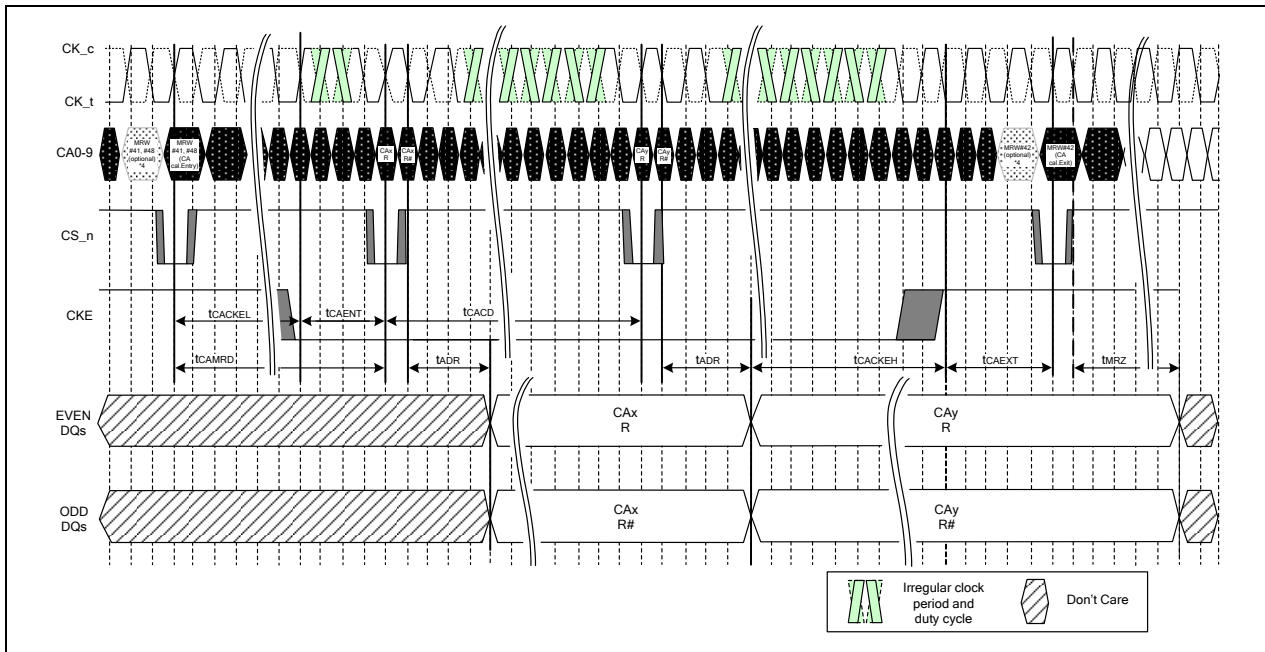

Figure 44 – CA Training Timing Chart

Notes:

1. Unused DQ must be valid HIGH or LOW during data output period. Unused DQ may transition at the same time as the active DQ. DQS must remain static and not transition.
2. CA to DQ mapping change via MR 48 omitted here for clarity of the timing diagram. Both MR41 and MR48 training sequences must be completed before exiting the training mode (MR42). To enable a CA to DQ mapping change, CKE must be driven HIGH prior to issuance of the MRW 48 command.
3. Because data out control is asynchronous and will be an analog delay from when all the CA data is available, tADR and tMRZ are defined from CK_t falling edge.
4. It is recommended to hold the CA bus stable for one cycle prior to and one cycle after the issuance of the MRW CA training entry/exit command to ensure setup and hold timings on the CA bus.
5. Clock phase may be adjusted in CA training mode while CS_n is high and CKE is low resulting in an irregular clock with shorter/longer periods and pulse widths.



The LPDDR3 SDRAM may not properly recognize a Mode Register Write command at normal operation frequency before CA Training is finished. Special encodings are provided for CA Training mode enable/disable. MR41 and MR42 encodings are selected so that rising edge and falling edge values are the same. The LPDDR3 SDRAM will recognize MR41 and MR42 at normal operation frequency even before CA timing adjustment is finished.

Calibration data will be output through DQ pins. CA to DQ mapping is described in CA to DQ mapping (CA Training mode enabled with MR41) table.

After timing calibration with MR41 is finished, users will issue MRW to MR48 and calibrate remaining CA pins (CA4 and CA9) using (DQ0/DQ1 and DQ8/DQ9) as calibration data output pins. See the CA to DQ mapping (CA Training mode is enabled with MR48) table.

CA Training timing values are specified in section 8.8.1 “LPDDR3 AC Timing” Table.

CA Training mode enable (MR41(29H, 0010 1001b), OP=A4H(1010 0100b))

	CA0	CA1	CA2	CA3	CA4	CA5	CA6	CA7	CA8	CA9
Rising Edge	L	L	L	L	H	L	L	H	L	H
Falling Edge	L	L	L	L	H	L	L	H	L	H

CA Training mode disable (MR42(2AH, 0010 1010b), OP=A8H(1010 1000b))

	CA0	CA1	CA2	CA3	CA4	CA5	CA6	CA7	CA8	CA9
Rising Edge	L	L	L	L	L	H	L	H	L	H
Falling Edge	L	L	L	L	L	H	L	H	L	H

CA to DQ mapping (CA Training mode enabled with MR41)

CA0	CA1	CA2	CA3	CA5	CA6	CA7	CA8	Clock edge
DQ0	DQ2	DQ4	DQ6	DQ8	DQ10	DQ12	DQ14	CK_t rising edge
DQ1	DQ3	DQ5	DQ7	DQ9	DQ11	DQ13	DQ15	CK_t falling edge

CA Training mode enable (MR48(30H, 0011 0000b), OP=C0H(1100 0000b))

	CA0	CA1	CA2	CA3	CA4	CA5	CA6	CA7	CA8	CA9
Rising Edge	L	L	L	L	L	L	L	L	H	H
Falling Edge	L	L	L	L	L	L	L	L	H	H

CA to DQ mapping (CA Training mode is enabled with MR48)

CA4	CA9	Clock edge
DQ0	DQ8	CK_t rising edge
DQ1	DQ9	CK_t falling edge

Note: Other DQs must have valid output (either HIGH or LOW)



7.4.13.4 Mode Register Write – WR Leveling Mode

In order to provide for improved signal integrity performance, the LPDDR3 SDRAM provides a write leveling feature to compensate for timing skew, affecting timing parameters such as t_{DQSS} , t_{DSS} , and t_{DSH} .

The memory controller uses the write leveling feature to receive feedback from the SDRAM allowing it to adjust the clock to data strobe signal relationship for each DQS_t/DQS_c signal pair. The memory controller performing the leveling must have adjustable delay setting on DQS_t/DQS_c signal pair to align the rising edge of DQS signals with that of the clock signal at the DRAM pin. The DRAM asynchronously feeds back CLK, sampled with the rising edge of DQS signals. The controller repeatedly delays DQS signals until a transition from 0 to 1 is detected. The DQS signals delay established through this exercise ensures the t_{DQSS} specification can be met.

All DQS signals may have to be leveled independently. During Write Leveling operations each DQS signal latches the clock with a rising strobe edge and drives the result on all DQ[n] of its respective byte.

The LPDDR3 SDRAM enters into write leveling mode when mode register MR2[7] is set HIGH. When entering write leveling mode, the state of the DQ pins is undefined. During write leveling mode, only NOP commands are allowed, or MRW command to exit write leveling operation. Upon completion of the write leveling operation, the DRAM exits from write leveling mode when MR2[7] is reset LOW.

The controller will drive DQS_t LOW and DQS_c HIGH after a delay of $t_{WLDQSEN}$. After time t_{WLMRD} , the controller provides DQS signal input which is used by the DRAM to sample the clock signal driven from the controller. The delay time $t_{WLMRD(max)}$ is controller dependent. The DRAM samples the clock input with the rising edge of DQS and provides asynchronous feedback on all the DQ bits after time t_{WLO} . The controller samples this information and either increment or decrement the DQS_t and/or DQS_c delay settings and launches the next DQS/DQS# pulse. The sample time and trigger time is controller dependent. Once the following DQS_t/DQS_c transition is sampled, the controller locks the strobe delay settings, and write leveling is achieved for the device. Figure 45 describes the timing for the write leveling operation.

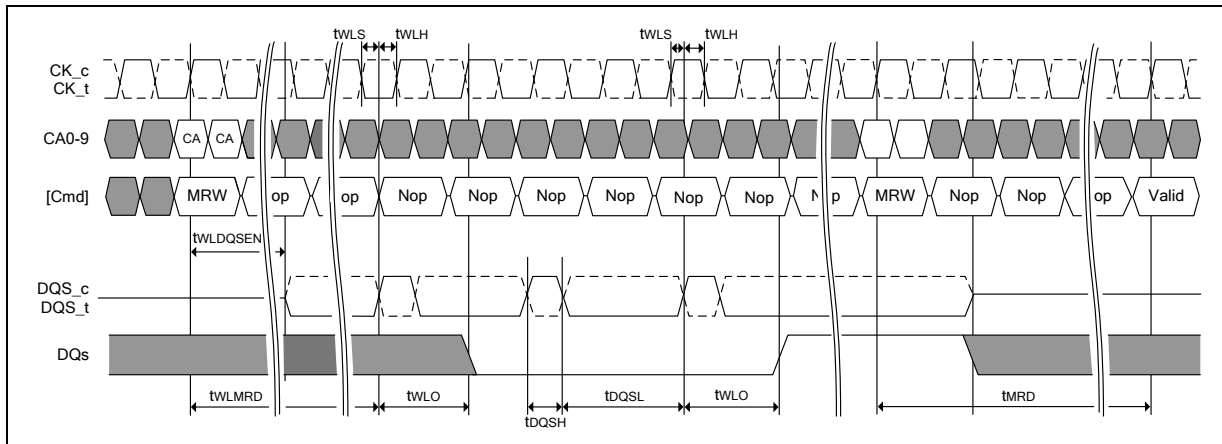

Figure 45 - Write Leveling Timing



7.4.14 On-Die Termination

ODT (On-Die Termination) is a feature of the LPDDR3 SDRAM that allows the DRAM to turn on/off termination resistance for each DQ, DQS_t, DQS_c and DM via the ODT control pin. The ODT feature is designed to improve signal integrity of the memory channel by allowing the DRAM controller to independently turn on/off termination resistance for any or all DRAM devices. Unlike other command inputs, the ODT pin directly controls ODT operation and is not sampled by the clock.

The ODT feature is turned off and not supported in Self-Refresh and Deep Power Down modes. ODT operation can optionally be enabled during CKE Power Down via a mode register. Note that if ODT is enabled during Power Down mode VDDQ may not be turned off during Power Down. The DRAM will also disable termination during read operations.

A simple functional representation of the DRAM ODT feature is shown below.

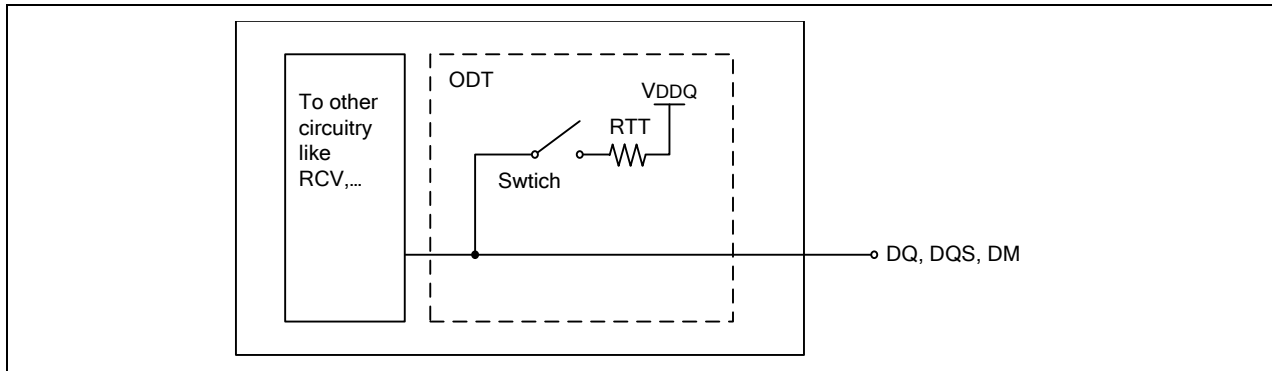

Figure 46 - Functional Representation of ODT

The switch is enabled by the internal ODT control logic, which uses the external ODT pin and other mode register control information. The value of RTT is determined by the settings of Mode Register bits. The ODT pin will be ignored if the Mode Register MR11 is programmed to disable ODT, in self-refresh, in deep power down, in CKE power down (mode register option) and during read operations.

7.4.14.1 ODT Mode register

The ODT Mode is enabled if MR11 OP<1:0> are non zero. In this case, the value of RTT is determined by the settings of those bits. The ODT Mode is disabled if MR11 OP<1:0> are zero.

MR11 OP<2> determines whether ODT, if enabled through MR11 OP<1:0>, will operate during CKE power down.

7.4.14.2 Asynchronous ODT

The ODT feature is controlled asynchronously based on the status of the ODT pin, except ODT is off when:

- ODT is disabled through MR11 OP<1:0>.
- DRAM is performing a read operation (RD or MRR).
- DRAM is in CKE Power Down and MR11 OP<2> is zero.
- DRAM is in Self-Refresh or Deep Power Down modes.
- DRAM is in CA Training Mode.

In asynchronous ODT mode, the following timing parameters apply when ODT operation is controlled by the ODT pin: tODT_{on,min,max}, tODT_{off,min,max}.

Minimum RTT turn-on time (tODT_{on,min}) is the point in time when the device termination circuit leaves high impedance state and ODT resistance begins to turn on. Maximum RTT turn on time (tODT_{on,max}) is the point in time when the ODT resistance is fully on. tODT_{on,min} and tODT_{on,max} are measured from ODT pin high.

Minimum RTT turn-off time (tODT_{off,min}) is the point in time when the device termination circuit starts to turn off the ODT resistance. Maximum ODT turn off time (tODT_{off,max}) is the point in time when the on-die termination has reached high impedance. tODT_{off,min} and tODT_{off,max} are measured from ODT pin low.



7.4.14.3 ODT During Read Operations (RD or MRR)

During read operations, LPDDR3 SDRAM will disable termination and disable ODT control through the ODT pin. After read operations are completed, ODT control is resumed through the ODT pin (if ODT Mode is enabled).

7.4.14.4 ODT During Power Down

When MR11 OP<2> is zero, termination control through the ODT pin will be disabled when the DRAM enters CKE power down. After a power down command is registered, termination will be disabled within a time window specified by tODTd,min,max. After a power down exit command is registered, termination will be enabled within a time window specified by tODTe,min,max.

Minimum RTT disable time (tODTd,min) is the point in time when the device termination circuit will no longer be controlled by the ODT pin. Maximum ODT disable time (tODTd,max) is the point in time when the on-die termination will be in high impedance.

Minimum RTT enable time (tODTe,min) is the point in time when the device termination circuit will no longer be in high impedance. The ODT pin shall control the device termination circuit after maximum ODT enable time (tODTe,max) is satisfied.

When MR11 OP<2> is enabled and MR11 OP<1:0> are non zero, ODT operation is supported during CKE power down with ODT control through the ODT pin.

7.4.14.5 ODT During Self Refresh

LPDDR3 SDRAM disables the ODT function during self refresh. After a self refresh command is registered, termination will be disabled within a time window specified by tODTd,min,max. After a self refresh exit command is registered, termination will be enabled within a time window specified by tODTe,min,max.

7.4.14.6 ODT During Deep Power Down

LPDDR3 SDRAM disables the ODT function during deep power down. After a deep power down command is registered, termination will be disabled within a time window specified by tODTd,min,max.

7.4.14.7 ODT During CA Training and Write Leveling

During CA Training Mode, LPDDR3 SDRAM will disable on-die termination and ignore the state of the ODT control pin. For ODT operation during Write Leveling mode, refer to the table below for termination activation and deactivation for DQ and DQS_t/DQS_c.

DRAM Termination Function In Write Leveling Mode

ODT pin	DQS_t/DQS_c termination	DQ termination
De-asserted	OFF	OFF
Asserted	ON	OFF

If ODT is enabled, the ODT pin must be high, in Write Leveling mode.

ODT States Truth Table

	Write	Read/DQ Cal	ZQ Cal	CA Training	Write Level
DQ Termination	Enabled	Disabled	Disabled	Disabled	Disabled
DQS Termination	Enabled	Disabled	Disabled	Disabled	Enabled

Note: ODT is enabled with MR11[1:0]=01b, 10b, or 11b and ODT pin HIGH. ODT is disabled with MR11[1:0]=00b or ODT pin LOW.

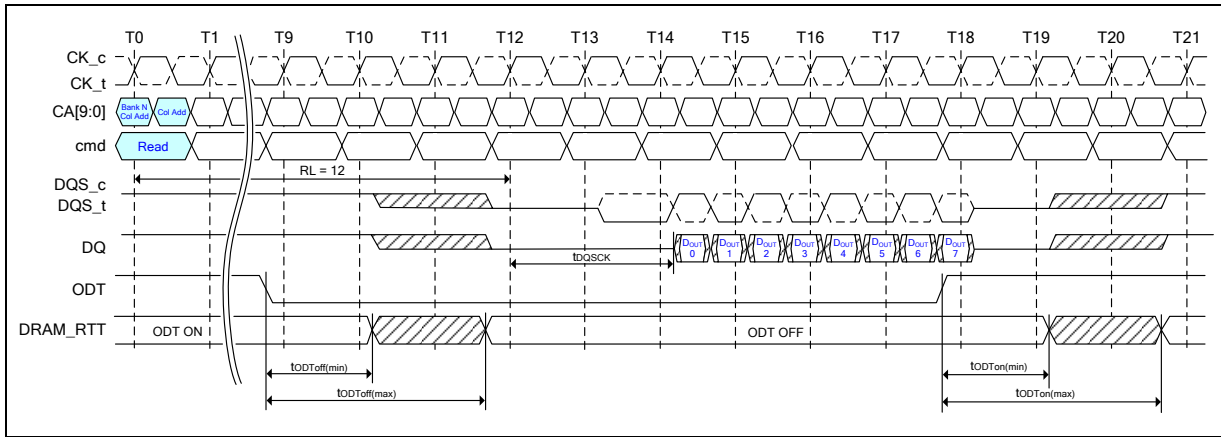

Figure 47 – Asynchronous ODT Timing Example for RL = 12

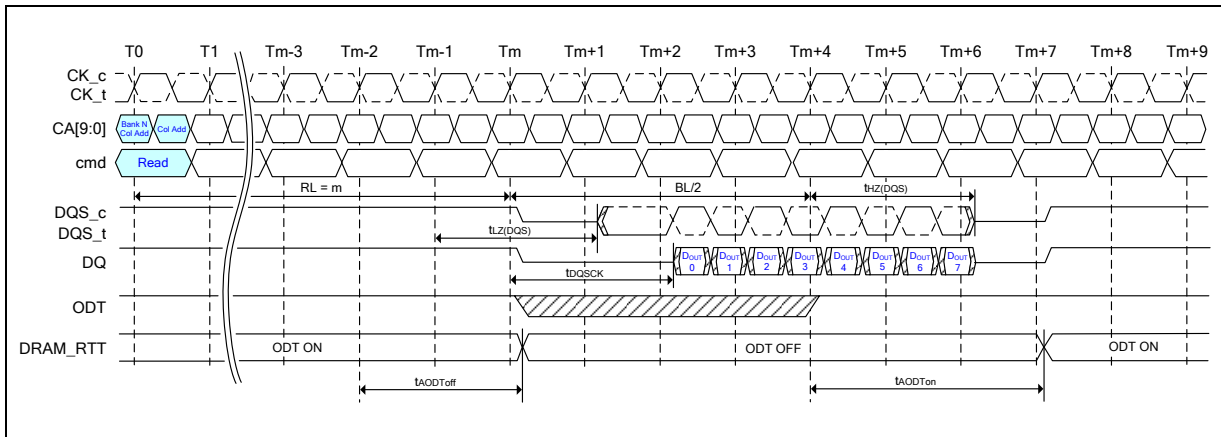

Figure 48 - Automatic ODT Timing During READ Operation Example for RL = m

Notes:

1. The automatic RTT turn-off delay, $t_{AODTOff}$, is referenced from the rising edge of “RL-2” clock at T_{m-2} .
2. The automatic RTT turn-on delay, t_{AODTon} , is referenced from the rising edge of “RL+ BL/2” clock at T_{m+4} .

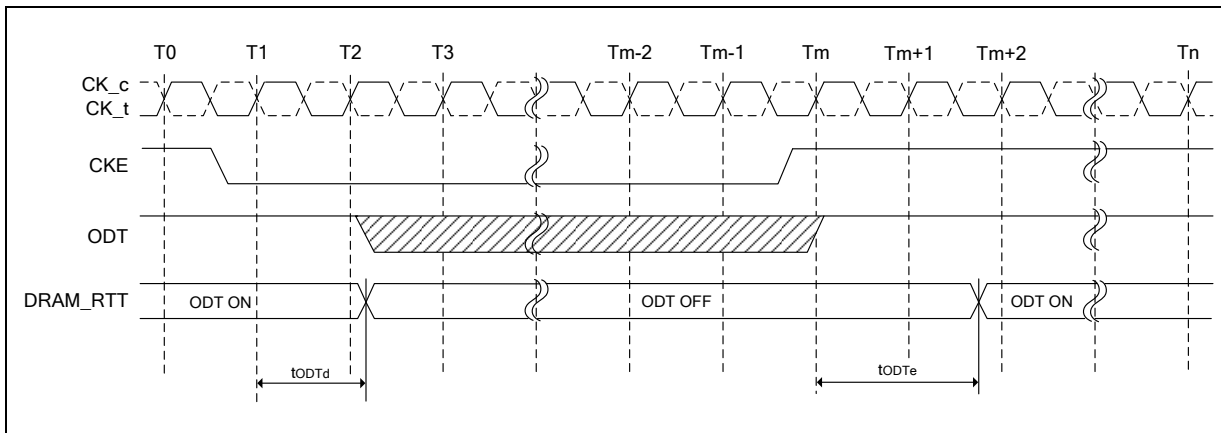

Figure 49 –ODT Timing During Power Down, Self Refresh, Deep Power Down Entry/Exit Example

Notes:

1. Upon exit of Deep Power Down mode, a complete power-up initialization sequence is required.
2. t_{ODTd} has a different value if the command at T_1 is normal Power Down entry, Deep Power Down entry or Self Refresh entry; see section 8.8.1 “LPDDR3 AC Timing” Table.



7.4.15 Power-Down

Power-down is entered synchronously when CKE is registered LOW and CS_n is HIGH at the rising edge of clock. CKE must not go LOW while MRR, MRW, Read, or Write operations are in progress. CKE can go LOW while any other operations such as row activation, Precharge, auto precharge, or Refresh are in progress, but the power-down IDD specification will not be applied until such operations are complete. Power-down entry and exit are shown in Figure 50 to Figure 61.

Entering power-down deactivates the input and output buffers, excluding CKE. To ensure that there is enough time to account for internal delay on the CKE signal path, two NOP commands are required after CKE is driven LOW, this timing period is defined as tCPDED. CKE LOW will result in deactivation of input receivers after tCPDED has expired. In power-down mode, CKE must be held LOW; all other input signals are "Don't Care". CKE LOW must be maintained until tCKE,min is satisfied. VREFCA must be maintained at a valid level during power-down.

VDDQ can be turned off during power-down. If VDDQ is turned off, VREFDQ must also be turned off. Prior to exiting power-down, both VDDQ and VREFDQ must be within their respective minimum/maximum operating ranges.

No refresh operations are performed in power-down mode. The maximum duration in power-down mode is only limited by the refresh requirements outlined in the Refresh command section.

The power-down state is exited when CKE is registered HIGH. The controller must drive CS_n HIGH in conjunction with CKE HIGH when exiting the power-down state. CKE HIGH must be maintained until tCKE,min is satisfied. A valid, executable command can be applied with power-down exit latency tXP after CKE goes HIGH. Power-down exit latency is defined in the AC timing parameter table.

If power-down occurs when all banks are idle, this mode is referred to as idle power-down; if power-down occurs when there is a row active in any bank, this mode is referred to as active power-down. For the description of ODT operation and specifications during power-down entry and exit, see section 7.4.14 "On-Die Termination".

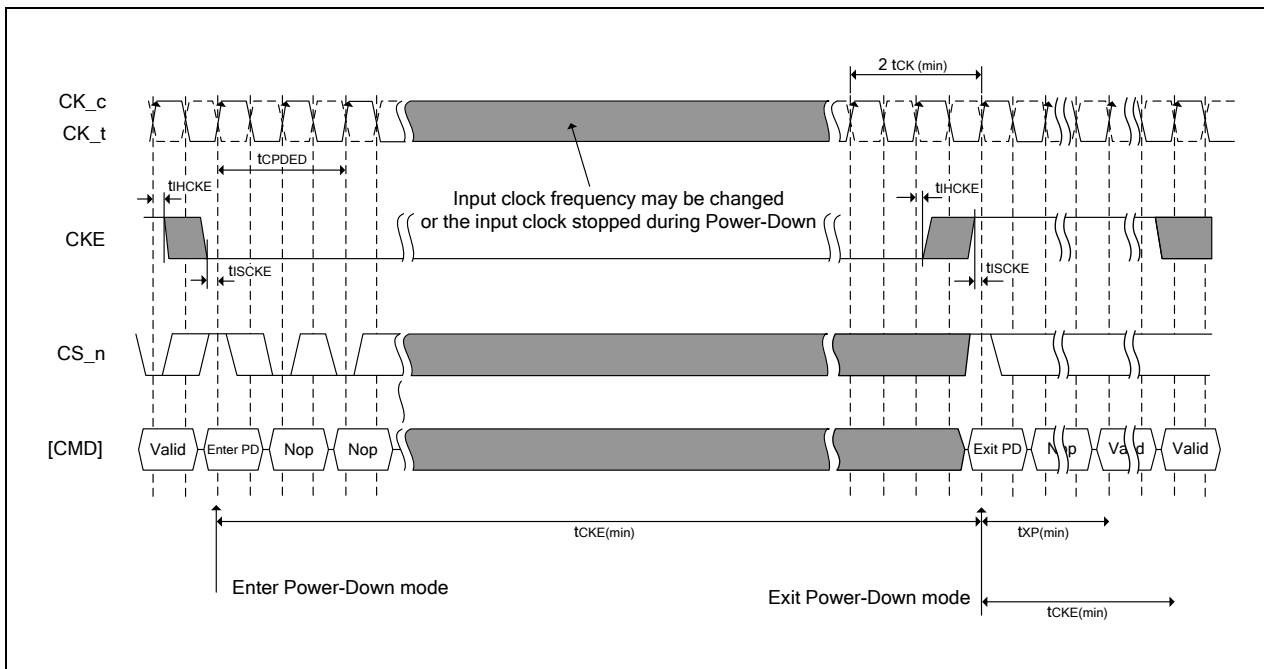

Figure 50 - Basic Power-Down Entry and Exit Timing

Note:

Input clock frequency can be changed or the input clock can be stopped or floated during power-down, provided that upon exiting power-down, the clock is stable and within specified limits for a minimum of 2 clock cycles prior to power-down exit and the clock frequency is between the minimum and maximum specified frequency for the speed grade in use.

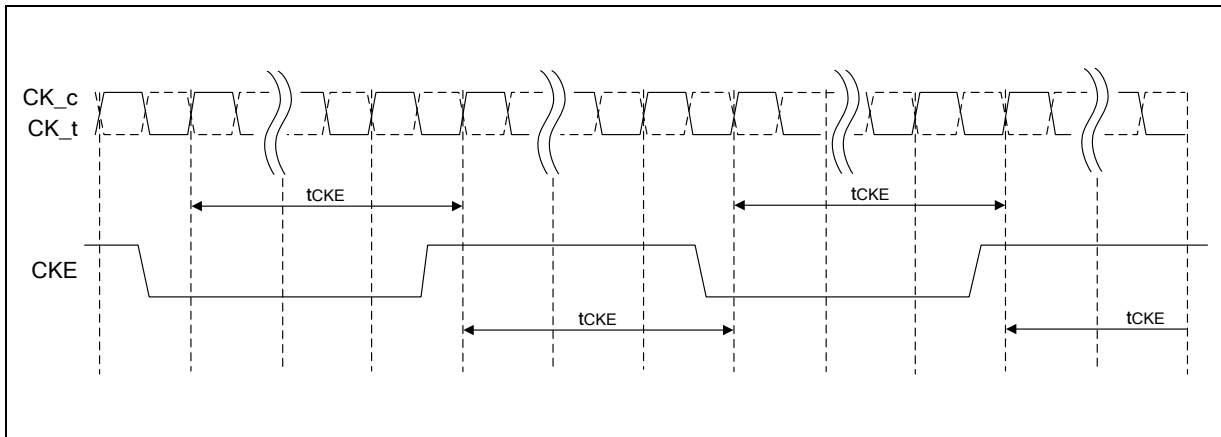

Figure 51 - CKE-Intensive Environment

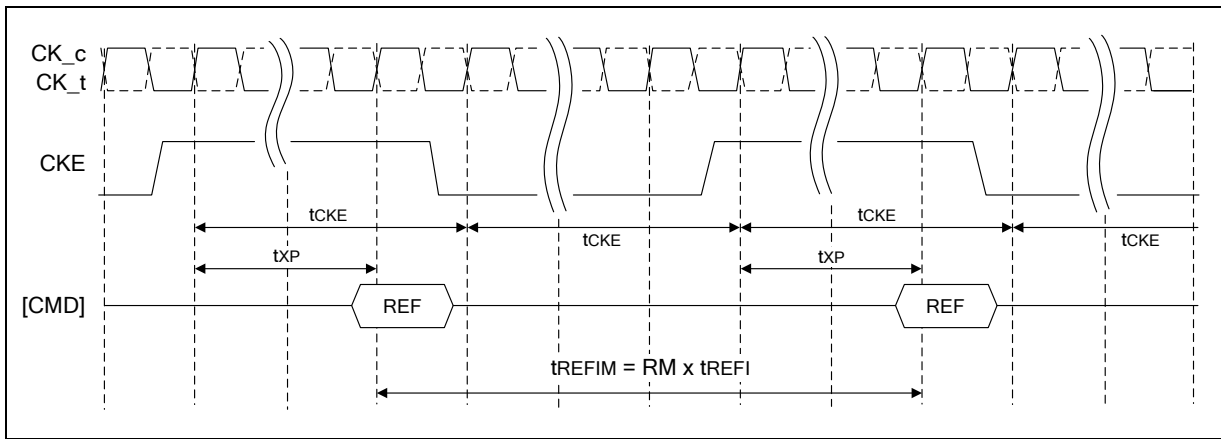

Figure 52 - Refresh-to-Refresh Timing in CKE-Intensive Environments

Note:

The pattern shown can repeat over an extended period of time. With this pattern, all AC and DC timing and voltage specifications with temperature and voltage drift are ensured.

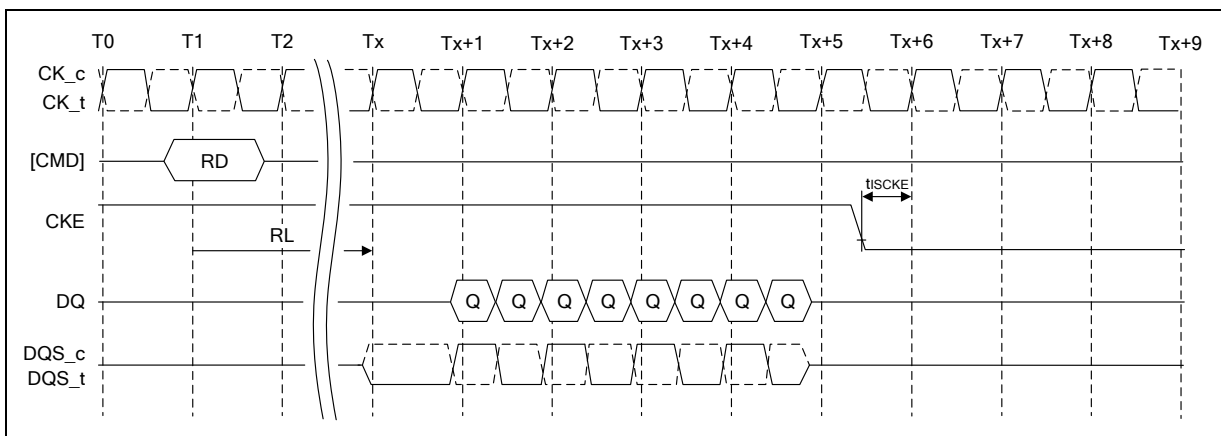

Figure 53 - Read to Power-Down Entry

Notes:

1. CKE must be held HIGH until the end of the burst operation.
2. CKE can be registered LOW at RL + RU(tDQSCK(MAX)/tCK) + BL/2 + 1 clock cycles after the clock on which the Read command is registered.

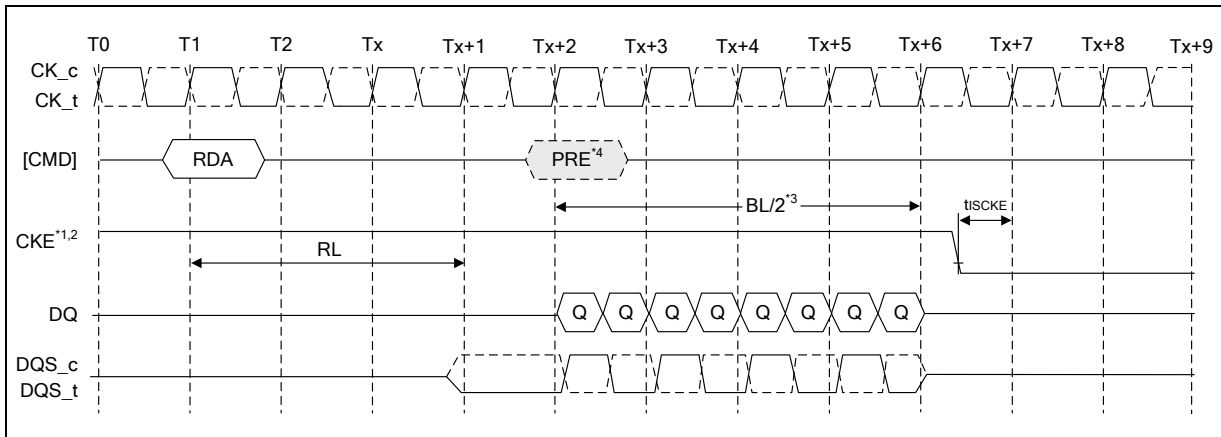

Figure 54 - Read with Auto Precharge to Power-Down Entry

Notes:

1. CKE must be held HIGH until the end of the burst operation.
2. CKE can be registered LOW at $RL + RU(tDQSCK/tCK) + BL/2 + 1$ clock cycles after the clock on which the Read command is registered.
3. $BL/2$ with $tRTP = 7.5nS$ and $tRAS(MIN)$ is satisfied.
4. Start internal Precharge.

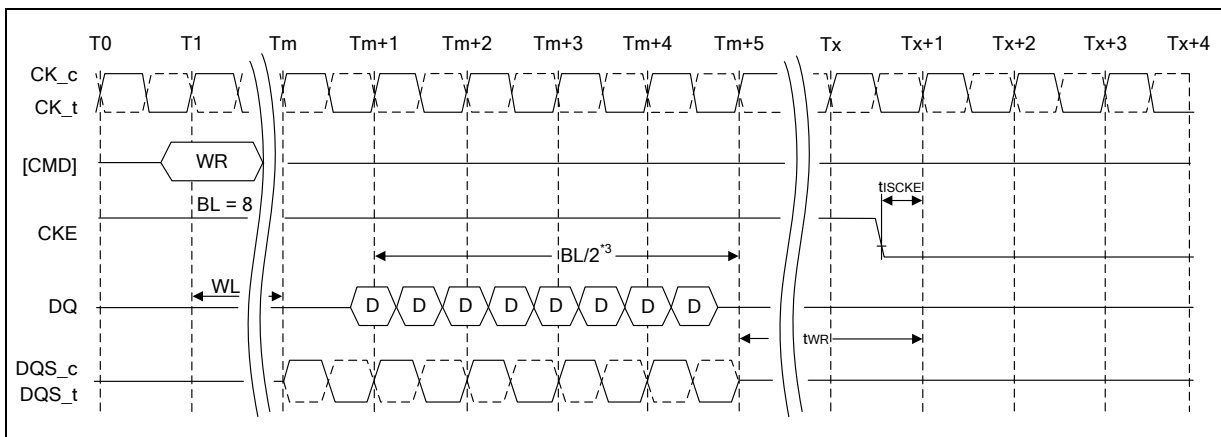

Figure 55 - Write to Power-Down Entry

Note:

CKE can be registered LOW at $WL + 1 + BL/2 + RU(tWR/tCK)$ clock cycles after the clock on which the Write command is registered.

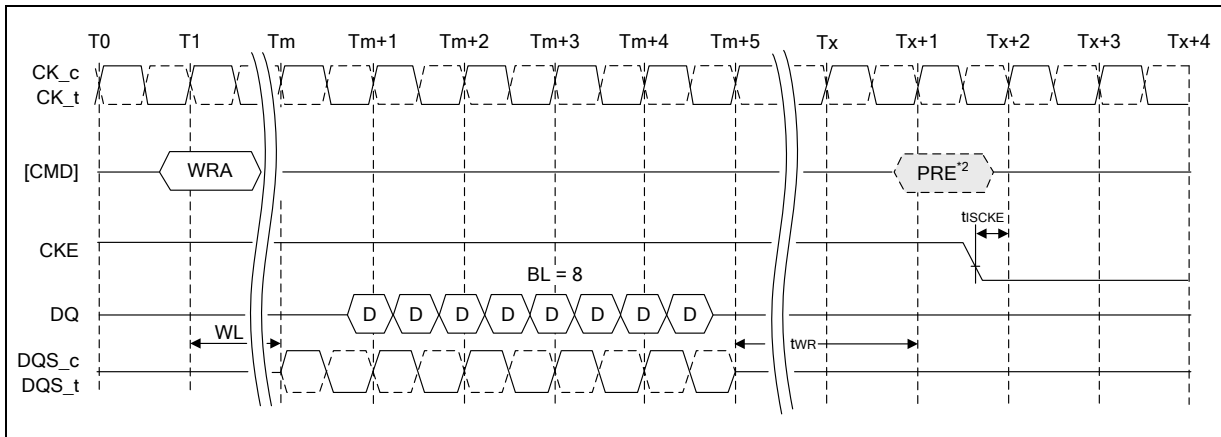

Figure 56 - Write with Auto Precharge to Power-Down Entry

Notes:

1. CKE can be registered LOW at $WL + 1 + BL/2 + RU(tWR/tCK) + 1$ clock cycles after the Write command is registered.
2. Start internal Precharge.

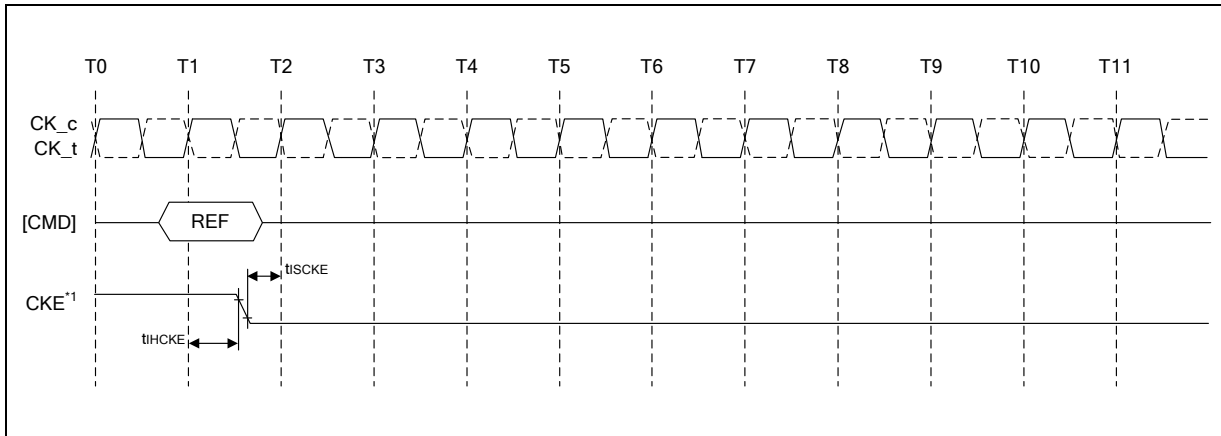

Figure 57 - Refresh Command to Power-Down Entry

Note:

1. CKE can go LOW $tIHCKE$ after the clock on which the Refresh command is registered.

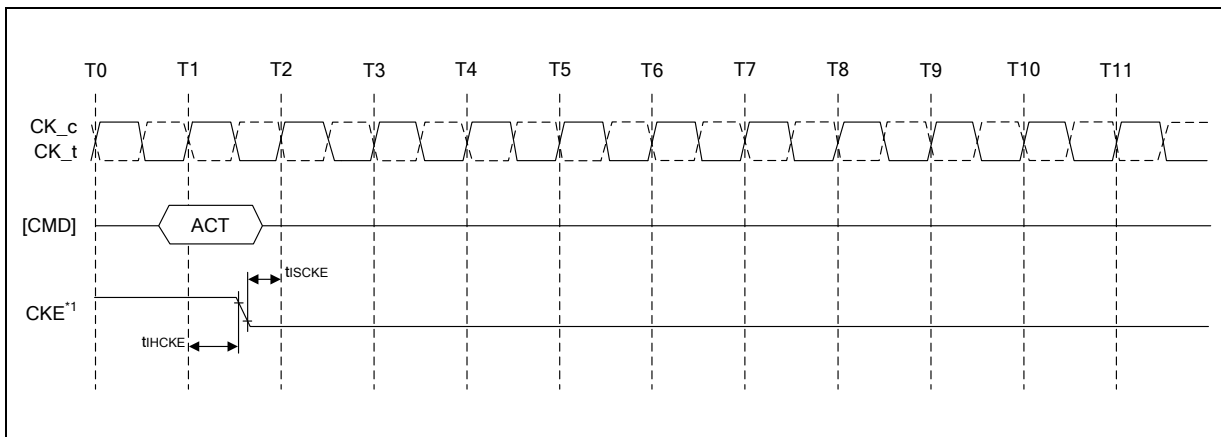

Figure 58 - Activate Command to Power-Down Entry

Note:

1. CKE can go LOW at $tIHCKE$ after the clock on which the Activate command is registered.

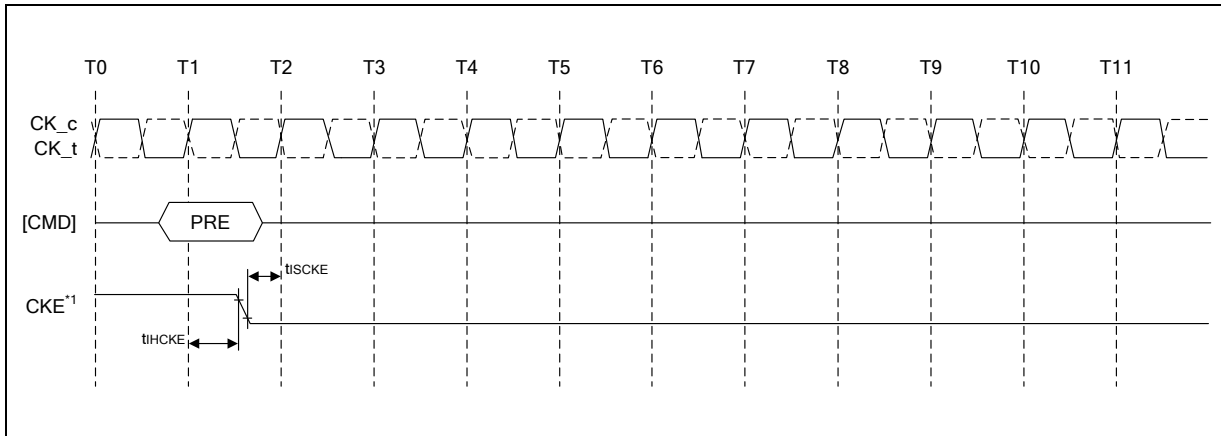

Figure 59 - Precharge Command to Power-Down Entry

Note:

CKE can go LOW tIHCKE after the clock on which the Precharge command is registered.

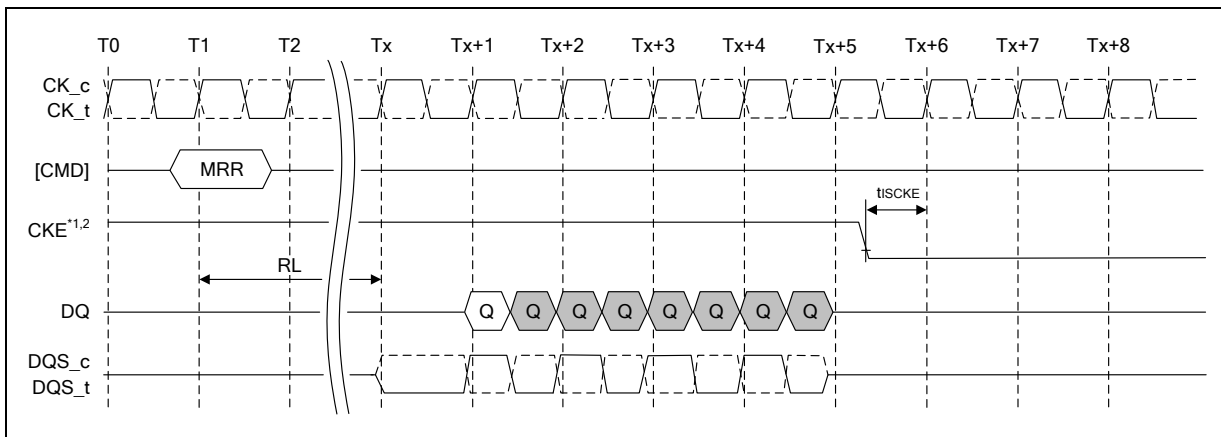

Figure 60 - MRR to Power-Down Entry

Notes:

1. CKE can be registered LOW $RL + RU(tDQSCK/tCK) + BL/2 + 1$ clock cycles after the clock on which the MRR command is registered.
2. CKE should be held high until the end of the burst operation.

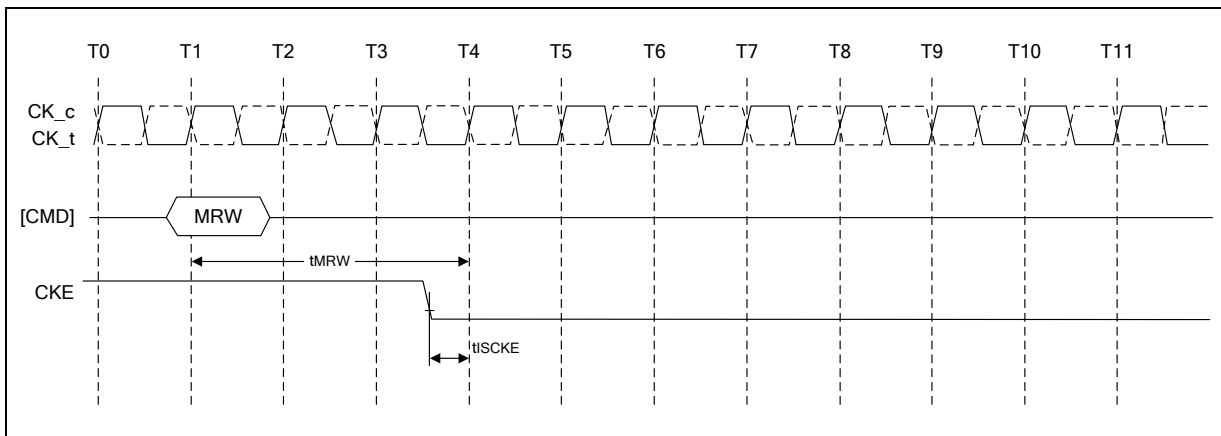

Figure 61 - MRW to Power-Down Entry

Note:

CKE can be registered LOW tMRW after the clock on which the MRW command is registered.



7.4.16 Deep Power-Down

Deep Power-Down is entered when CKE is registered LOW with CS_n LOW, CA0 HIGH, CA1 HIGH, and CA2 LOW at the rising edge of clock. All banks must be in idle state with no activity on the data bus prior to entering the Deep Power-Down mode. During Deep Power-Down, CKE must be held LOW. The contents of the SDRAM will be lost upon entry into Deep Power-Down mode.

In Deep Power-Down mode, all input buffers except CKE, all output buffers, and the power supply to internal circuitry may be disabled within the SDRAM. To ensure that there is enough time to account for internal delay on the CKE signal path, two NOP commands are required after CKE is driven LOW, and this timing period is defined as tCPDED.

CKE LOW will result in deactivation of command and address receivers after tCPDED has expired. All power supplies must be within specified limits prior to exiting Deep Power-Down. VREFDQ and VREFCA may be at any level within minimum and maximum levels (See “**Absolute Maximum DC Ratings**”). However prior to exiting Deep Power-Down, VREF must be within specified limits (See “**Recommended DC Operating Conditions**”).

The Deep Power-Down state is exited when CKE is registered HIGH, while meeting tISCKE with a stable clock input. The SDRAM must be fully re-initialized as described in the power up initialization sequence. The SDRAM is ready for normal operation after the initialization sequence is completed. For the description of ODT operation and specifications during DPD entry and exit, see section 7.4.14 “**On-Die Termination**”.

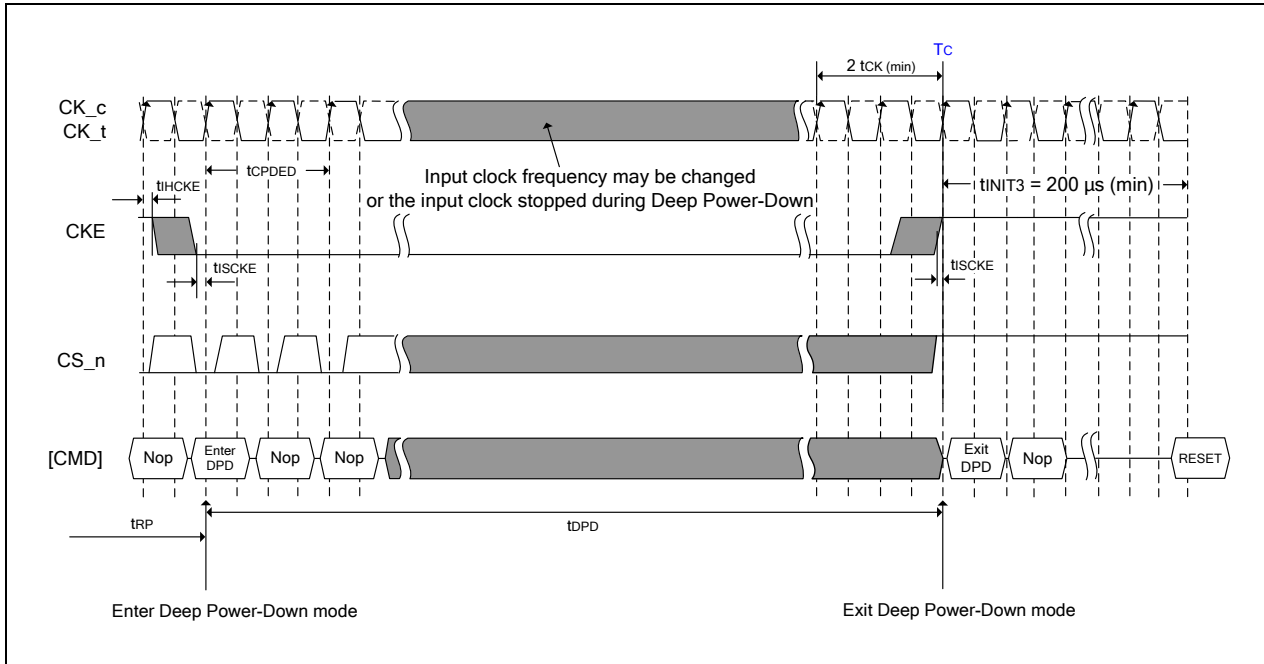

Figure 62 - Deep power down entry and exit timing diagram

Notes:

1. Initialization sequence may start at any time after Tc.
2. tINIT3, and Tc refer to timings in the LPDDR3 initialization sequence. For more detail, see Power-Up and Initialization.
3. Input clock frequency may be changed or the input clock can be stopped or floated during deep power-down, provided that upon exiting deep power-down, the clock is stable and within specified limits for a minimum of 2 clock cycles prior to deep power-down exit and the clock frequency is between the minimum and maximum frequency for the particular speed grade.



7.4.17 Input clock stop and frequency change

LPDDR3 SDRAMs support input clock frequency change during CKE LOW under the following conditions:

- $t_{CK(ABS)min}$ is met for each clock cycle;
- Refresh requirements apply during clock frequency change;
- During clock frequency change, only REFab or REFpb commands may be executing;
- Any Activate, or Precharge commands have executed to completion prior to changing the frequency;
- The related timing conditions (t_{RCD} , t_{RP}) have been met prior to changing the frequency;
- The initial clock frequency shall be maintained for a minimum of 2 clock cycles after CKE goes LOW;
- The clock satisfies $t_{CH(ABS)}$ and $t_{CL(ABS)}$ for a minimum of 2 clock cycles prior to CKE going HIGH.

After the input clock frequency is changed and CKE is held HIGH, additional MRW commands may be required to set the WR, RL etc. These settings may need to be adjusted to meet minimum timing requirements at the target clock frequency.

LPDDR3 devices support clock stop during CKE LOW under the following conditions:

- CK_t is held LOW and CK_c is held HIGH or both are floated during clock stop;
- Refresh requirements apply during clock stop;
- During clock stop, only REFab or REFpb commands may be executing;
- Any Activate, or Precharge commands have executed to completion prior to stopping the clock;
- The related timing conditions (t_{RCD} , t_{RP}) have been met prior to stopping the clock;
- The initial clock frequency shall be maintained for a minimum of 2 clock cycles after CKE goes LOW;
- The clock satisfies $t_{CH(ABS)}$ and $t_{CL(ABS)}$ for a minimum of 2 clock cycles prior to CKE going HIGH.

LPDDR3 devices support input clock frequency change during CKE HIGH under the following conditions:

- $t_{CK(ABS)min}$ is met for each clock cycle;
- Refresh requirements apply during clock frequency change;
- Any Activate, Read, Write, Precharge, Mode Register Write, or Mode Register Read commands must have executed to completion, including any associated data bursts prior to changing the frequency;
- The related timing conditions (t_{RCD} , t_{WR} , t_{WRA} , t_{RP} , t_{MRW} , t_{MRR} , etc.) have been met prior to changing the frequency;
- CS_n shall be held HIGH during clock frequency change;
- During clock frequency change, only REFab or REFpb commands may be executing;
- The LPDDR3 device is ready for normal operation after the clock satisfies $t_{CH(ABS)}$ and $t_{CL(ABS)}$ for a minimum of $2 \times t_{CK} + t_{XP}$.

After the input clock frequency is changed, additional MRW commands may be required to set the WR, RL etc. These settings may need to be adjusted to meet minimum timing requirements at the target clock frequency.

LPDDR3 devices support clock stop during CKE HIGH under the following conditions:

- CK_t is held LOW and CK_c is held HIGH during clock stop;
- CS_n shall be held HIGH during clock stop;
- Refresh requirements apply during clock stop;
- During clock stop, only REFab or REFpb commands may be executing;
- Any Activate, Read, Write, Precharge, Mode Register Write, or Mode Register Read commands must have executed to completion, including any associated data bursts prior to stopping the clock;
- The related timing conditions (t_{RCD} , t_{WR} , t_{WRA} , t_{RP} , t_{MRW} , t_{MRR} , etc.) have been met prior to stopping the clock;
- The LPDDR3 device is ready for normal operation after the clock is restarted and satisfies $t_{CH(ABS)}$ and $t_{CL(ABS)}$ for a minimum of $2 \times t_{CK} + t_{XP}$.

**7.4.18 No Operation Command**

The purpose of the No Operation command (NOP) is to prevent the LPDDR3 device from registering any unwanted command between operations. Only when the CKE level is constant for clock cycle N-1 and clock cycle N, a NOP command may be issued at clock cycle N. A NOP command has two possible encodings:

1. CS_n HIGH at the clock rising edge N.
2. CS_n LOW and CA0, CA1, CA2 HIGH at the clock rising edge N.

The No Operation command will not terminate a previous operation that is still executing, such as a burst read or write cycle.



7.5 Truth Tables

Operation or timing that is not specified is illegal, and after such an event, in order to guarantee proper operation, the LPDDR3 device must be powered down and then restarted through the specified initialization sequence before normal operation can continue.

7.5.1 Command Truth Table

SDRAM Command	SDR Command Pins			DDR CA Pins (10)										CK_t EDGE
	CKE		CS_n	CA0	CA1	CA2	CA3	CA4	CA5	CA6	CA7	CA8	CA9	
	CK_t(n-1)	CK_t(n)												
MRW	H	H	L	L	L	L	L	MA0	MA1	MA2	MA3	MA4	MA5	↕
			X	MA6	MA7	OP0	OP1	OP2	OP3	OP4	OP5	OP6	OP7	↘
MRR	H	H	L	L	L	L	H	MA0	MA1	MA2	MA3	MA4	MA5	↕
			X	MA6	MA7	X						↘		
Refresh (per bank)	H	H	L	L	L	H	L	X						↕
			X	X						↘				
Refresh (all bank)	H	H	L	L	L	H	H	X						↕
			X	X						↘				
Enter Self Refresh	H	L	L	L	L	H	X						↕	
	X		X						↘					
Activate (bank)	H	H	L	L	H	R8	R9	R10	R11	R12	BA0	BA1	BA2	↕
			X	R0	R1	R2	R3	R4	R5	R6	R7	X	X	↘
Write (bank)	H	H	L	H	L	L	RFU	RFU	C1	C2	BA0	BA1	BA2	↕
			X	AP*3	C3	C4	C5	C6	C7	C8	C9	X	X	↘
Read (bank)	H	H	L	H	L	H	RFU	RFU	C1	C2	BA0	BA1	BA2	↕
			X	AP*3	C3	C4	C5	C6	C7	C8	C9	X	X	↘
Precharge ¹¹ (per bank, all bank)	H	H	L	H	H	L	H	AB*11	X	X	BA0	BA1	BA2	↕
			X	X	X	X	X	X	X	X	X	X	X	↘
Enter Deep Power Down	H	L	L	H	H	L	X						↕	
	X		X						↘					
NOP	H	H	L	H	H	H	X						↕	
			X	X						↘				
Maintain PD, SREF, DPD (NOP) See note 4	L	L	L	H	H	H	X						↕	
			X	X						↘				
NOP	H	H	H	X						↕				
			X	X						↘				
Maintain PD, SREF, DPD See note 4	L	L	X	X						↕				
			X	X						↘				
Enter Power Down	H	L	H	X						↕				
	X		X						↘					
Exit PD, SREF,DPD	L	H	H	X						↕				
	X		X						↘					



Notes:

1. All LPDDR3 commands are defined by states of CS_n, CA0, CA1, CA2, CA3, and CKE at the rising edge of the clock.
2. Bank addresses BA0, BA1, BA2 (BA) determine which bank is to be operated upon.
3. AP "high" during a Read or Write command indicates that an auto-precharge will occur to the bank associated with the Read or Write command.
4. "X" means "H or L (but a defined logic level)", except when the LPDDR3 SDRAM is in PD, SREF, or DPD, in which case CS_n, CK_t/CK_c, and CA can be floated after the required tCPDED time is satisfied, and until the required exit procedure is initiated as described in the respective entry/exit procedure.
5. Self refresh exit and Deep Power Down exit are asynchronous.
6. VREF must be between 0 and VDDQ during Self Refresh and Deep Power Down operation.
7. CAx_r refers to command/address bit "x" on the rising edge of clock.
8. CAx_f refers to command/address bit "x" on the falling edge of clock.
9. CS_n and CKE are sampled at the rising edge of clock.
10. The least-significant column address C0 is not transmitted on the CA bus, and is implied to be zero.
11. AB "high" during Precharge command indicates that all bank Precharge will occur. In this case, Bank Address is don't care.
12. When CS_n is HIGH, LPDDR3 CA bus can be floated.

7.5.2 CKE Truth Table

Device Current State ^{*3}	CKEn-1 ^{*4}	CKEn ^{*4}	CS_n ^{*5}	Command n ^{*6}	Operation n ^{*6}	Device Next State	Notes
Active Power Down	L	L	X	X	Maintain Active Power Down	Active Power Down	
	L	H	H	NOP	Exit Active Power Down	Active	7
Idle Power Down	L	L	X	X	Maintain Idle Power Down	Idle Power Down	
	L	H	H	NOP	Exit Idle Power Down	Idle	7
Resetting Power Down	L	L	X	X	Maintain Resetting Power Down	Resetting Power Down	
	L	H	H	NOP	Exit Resetting Power Down	Idle or Resetting	7, 10
Deep Power Down	L	L	X	X	Maintain Deep Power Down	Deep Power Down	
	L	H	H	NOP	Exit Deep Power Down	Power On	9
Self Refresh	L	L	X	X	Maintain Self Refresh	Self Refresh	
	L	H	H	NOP	Exit Self Refresh	Idle	8
Bank(s) Active	H	L	H	NOP	Enter Active Power Down	Active Power Down	
All Banks Idle	H	L	H	NOP	Enter Idle Power Down	Idle Power Dow	11
	H	L	L	Enter Self Refresh	Enter Self Refresh	Self Refresh	
	H	L	L	Deep Power Down	Enter Deep Power Down	Deep Power Down	
Resetting	H	L	H	NOP	Enter Resetting Power Down	Resetting Power Down	
	H	H	Refer to the Command Truth Table				

Notes:

1. All states and sequences not shown are illegal or reserved unless explicitly described elsewhere in this document.
2. 'X' means 'Don't care'.
3. "Current state" is the state of the LPDDR3 device immediately prior to clock edge n.
4. "CKEn" is the logic state of CKE at clock rising edge n; "CKEn-1" was the state of CKE at the previous clock edge.
5. "CS_n" is the logic state of CS_n at the clock rising edge n;
6. "Command n" is the command registered at clock edge N, and "Operation n" is a result of "Command n".
7. Power Down exit time (tXP) should elapse before a command other than NOP is issued. The clock must toggle at least twice during the tXP period.
8. Self-Refresh exit time (tXSR) should elapse before a command other than NOP is issued. The clock must toggle at least twice during the tXSR time.
9. The Deep Power-Down exit procedure must be followed as discussed in the Deep Power-Down section of the Functional Description.
10. Upon exiting Resetting Power Down, the device will return to the idle state if tINIT5 has expired.
11. In the case of ODT disabled, all DQ output shall be Hi-Z. In the case of ODT enabled, all DQ shall be terminated to VDDQ.



7.5.3 State Truth Tables

The truth tables provide complementary information to the state diagram; they clarify the device behavior and the applied restrictions when considering the actual state of all banks.

Current State Bank n - Command to Bank n

Current State	Command	Operation	Next State	Notes
Any	NOP	Continue previous operation	Current State	
Idle	Activate	Select and activate row	Active	
	Refresh (Per Bank)	Begin to refresh	Refreshing(Per Bank)	6
	Refresh (All Bank)	Begin to refresh	Refreshing(All Bank)	7
	MRW	Write value to Mode Register	MR Writing	7
	MRR	Read value from Mode Register	Idle MR Reading	
	Reset	Begin Device Auto-Initialization	Resetting	8
	Precharge	Deactivate row in bank or banks	Precharging	9, 14
Row Active	Read	Select column, and start read burst	Reading	11
	Write	Select column, and start write burst	Writing	11
	MRR	Read value from Mode Register	Active MR Reading	
	Precharge	Deactivate row in bank or banks	Precharging	9
Reading	Read	Select column, and start new read burst	Reading	10, 11
	Write	Select column, and start write burst	Writing	10, 11, 12
Writing	Write	Select column, and start new write burst	Writing	10, 11
	Read	Select column, and start read burst	Reading	10, 11, 13
Power On	Reset	Begin Device Auto-Initialization	Resetting	8
Resetting	MRR	Read value from Mode Register	Resetting MR Reading	

Notes:

- The table applies when both CKEn-1 and CKEn are HIGH, and after tXSR or tXP has been met if the previous state was Power Down.
- All states and sequences not shown are illegal or reserved.
- Current State Definitions:
 Idle: The bank or banks have been precharged, and tRP has been met.
 Active: A row in the bank has been activated, and tRCD has been met. No data bursts / accesses and no register accesses are in progress.
 Reading: A Read burst has been initiated, with Auto Precharge disabled.
 Writing: A Write burst has been initiated, with Auto Precharge disabled.
- The following states must not be interrupted by a command issued to the same bank. NOP commands or allowable commands to the other bank should be issued on any clock edge occurring during these states. Allowable commands to the other banks are determined by its current state and according to Current State Bank n - Command to Bank m.
 Precharging: starts with the registration of a Precharge command and ends when tRP is met. Once tRP is met, the bank will be in the idle state.
 Row Activating: starts with registration of an Activate command and ends when tRCD is met. Once tRCD is met, the bank will be in the 'Active' state.
 Read with AP Enabled: starts with the registration of the Read command with Auto Precharge enabled and ends when tRP has been met. Once tRP has been met, the bank will be in the idle state.
 Write with AP Enabled: starts with registration of a Write command with Auto Precharge enabled and ends when tRP has been met. Once tRP is met, the bank will be in the idle state.



5. The following states must not be interrupted by any executable command; NOP commands must be applied to each positive clock edge during these states.
 - Refreshing (Per Bank): starts with registration of a Refresh (Per Bank) command and ends when tRFCpb is met. Once tRFCpb is met, the bank will be in an 'idle' state.
 - Refreshing (All Bank): starts with registration of a Refresh (All Bank) command and ends when tRFCab is met. Once tRFCab is met, the device will be in an 'all banks idle' state.
 - Idle MR Reading: starts with the registration of a MRR command and ends when tMRR has been met. Once tMRR has been met, the bank will be in the idle state.
 - Resetting MR Reading: starts with the registration of a MRR command and ends when tMRR has been met. Once tMRR has been met, the bank will be in the Resetting state.
 - Active MR Reading: starts with the registration of a MRR command and ends when tMRR has been met. Once tMRR has been met, the bank will be in the Active state.
 - MR Writing: starts with the registration of a MRW command and ends when tMRW has been met. Once tMRW has been met, the bank will be in the idle state.
 - Precharging All: starts with the registration of a Precharge-All command and ends when tRP is met. Once tRP is met, the bank will be in the idle state.
6. Bank-specific; requires that the bank is idle and no bursts are in progress.
7. Not bank-specific; requires that all banks are idle and no bursts are in progress.
8. Not bank-specific reset command is achieved through Mode Register Write command.
9. This command may or may not be bank specific. If all banks are being precharged, they must be in a valid state for precharging.
10. A command other than NOP should not be issued to the same bank while a Read or Write burst with Auto Precharge is enabled.
11. The new Read or Write command could be Auto Precharge enabled or Auto Precharge disabled.
12. A Write command may be applied after the completion of the Read burst; burst terminates are not permitted.
13. A Read command may be applied after the completion of the Write burst; burst terminates are not permitted.
14. If a Precharge command is issued to a bank in the idle state, tRP shall still apply.



Current State Bank n - Command to Bank m

Current State of Bank n	Command for Bank m	Operation	Next State for Bank m	Notes
Any	NOP	Continue previous operation	Current State of Bank m	
Idle	Any	Any command allowed to Bank m	-	18
Row Activating, Active, or Precharging	Activate	Select and activate row in Bank m	Active	6
	Read	Select column, and start read burst from Bank m	Reading	7
	Write	Select column, and start write burst to Bank m	Writing	7
	Precharge	Deactivate row in bank or banks	Precharging	8
	MRR	Read value from Mode Register	Idle MR Reading or Active MR Reading	9, 10, 12
Reading (Autoprecharge disabled)	Read	Select column, and start read burst from Bank m	Reading	7
	Write	Select column, and start write burst to Bank m	Writing	7, 13
	Activate	Select and activate row in Bank m	Active	
	Precharge	Deactivate row in bank or banks	Precharging	8
Writing (Autoprecharge disabled)	Read	Select column, and start read burst from Bank m	Reading	7, 15
	Write	Select column, and start write burst to Bank m	Writing	7
	Activate	Select and activate row in Bank m	Active	
	Precharge	Deactivate row in bank or banks	Precharging	8
Reading with Autoprecharge	Read	Select column, and start read burst from Bank m	Reading	7, 14
	Write	Select column, and start write burst to Bank m	Writing	7, 13, 14
	Activate	Select and activate row in Bank m	Active	
	Precharge	Deactivate row in bank or banks	Precharging	8
Writing with Autoprecharge	Read	Select column, and start read burst from Bank m	Reading	7, 14, 15
	Write	Select column, and start write burst to Bank m	Writing	7, 14
	Activate	Select and activate row in Bank m	Active	
	Precharge	Deactivate row in bank or banks	Precharging	8
Power On	Reset	Begin Device Auto-Initialization	Resetting	11, 16
Resetting	MRR	Read value from Mode Register	Resetting MR Reading	

Notes:

- The table applies when both CKEn-1 and CKEn are HIGH, and after tXSR or tXP has been met if the previous state was Self Refresh or Power Down.
- All states and sequences not shown are illegal or reserved.
- Current State Definitions:
 Idle: the bank has been precharged, and tRP has been met.
 Active: a row in the bank has been activated, and tRCD has been met. No data bursts/accesses and no register accesses are in progress.
 Reading: a Read burst has been initiated, with Auto Precharge disabled.
 Writing: a Write burst has been initiated, with Auto Precharge disabled.



4. Refresh, Self-Refresh, and Mode Register Write commands may only be issued when all bank are idle.
5. The following states must not be interrupted by any executable command; NOP commands must be applied during each clock cycle while in these states:
 - Idle MR Reading: starts with the registration of a MRR command and ends when tMRR has been met. Once tMRR has been met, the bank will be in the idle state.
 - Resetting MR Reading: starts with the registration of a MRR command and ends when tMRR has been met. Once tMRR has been met, the bank will be in the Resetting state.
 - Active MR Reading: starts with the registration of a MRR command and ends when tMRR has been met. Once tMRR has been met, the bank will be in the Active state.
 - MR Writing: starts with the registration of a MRW command and ends when tMRW has been met. Once tMRW has been met, the bank will be in the idle state.
6. tRRD must be met between Activate command to Bank n and a subsequent Activate command to Bank m. Additionally, in the case of multiple banks activated, tFAW must be satisfied.
7. Reads or Writes listed in the Command column include Reads and Writes with Auto Precharge enabled and Reads and Writes with Auto Precharge disabled.
8. This command may or may not be bank specific. If all banks are being precharged, they must be in a valid state for precharging.
9. MRR is allowed during the Row Activating state (Row Activating starts with registration of an Activate command and ends when tRCD is met).
10. MRR is allowed during the Precharging state. (Precharging starts with registration of a Precharge command and ends when tRP is met).
11. Not bank-specific; requires that all banks are idle and no bursts are in progress.
12. The next state for Bank m depends on the current state of Bank m (Idle, Row Activating, Precharging, or Active). The reader shall note that the state may be in transition when a MRR is issued. Therefore, if Bank m is in the Row Activating state and Precharging, the next state may be Active and Precharge dependent upon tRCD and tRP respectively.
13. A Write command may be applied after the completion of the Read burst, burst terminates are not permitted.
14. Read with auto precharge enabled or a Write with auto precharge enabled may be followed by any valid command to other banks provided that the timing restrictions described in the precharge and auto-precharge clarification table are followed.
15. A Read command may be applied after the completion of the Write burst; burst terminates are not permitted.
16. Reset command is achieved through Mode Register Write command.

7.5.4 Data Mask Truth Table

Name (Functional)	DM	DQs	Note
Write enable	L	Valid	1
Write inhibit	H	X	1

Note:

1. Used to mask write data, provided coincident with the corresponding data.



8. ELECTRICAL CHARACTERISTIC

8.1 Absolute Maximum DC Ratings

Stresses greater than those listed may cause permanent damage to the device. This is a stress rating only, and functional operation of the device at these or any other conditions above those indicated in the operational sections of this specification is not implied. Exposure to absolute maximum rating conditions for extended periods may affect reliability.

Parameter	Symbol	Min	Max	Units	Notes
VDD1 supply voltage relative to VSS	VDD1	-0.4	+2.3	V	1
VDD2 supply voltage relative to VSS	VDD2	-0.4	+1.6	V	1
VDDCA supply voltage relative to VSS	VDDCA	-0.4	+1.6	V	1, 2
VDDQ supply voltage relative to VSS	VDDQ	-0.4	+1.6	V	1, 3
Voltage on any pin relative to VSS	VIN, VOUT	-0.4	+1.6	V	
Storage Temperature	TSTG	-55	+125	°C	4

Notes:

- See "Voltage Ramp" in section 7.2.1 "Voltage Ramp and Device Initialization" for relationships between power supplies.
- $V_{REFCA} \leq 0.6 \times V_{DDCA}$; however, V_{REFCA} may be $\geq V_{DDCA}$ provided that $V_{REFCA} \leq 300\text{mV}$.
- $V_{REFDQ} \leq 0.7 \times V_{DDQ}$; however, V_{REFDQ} may be $\geq V_{DDQ}$ provided that $V_{REFDQ} \leq 300\text{mV}$.
- Storage Temperature is the case surface temperature on the center/top side of the LPDDR3 device. For the measurement conditions, please refer to JEESD51-2 standard.

8.2 AC & DC Operating Conditions

Operation or timing that is not specified is illegal, and after such an event, in order to guarantee proper operation, the LPDDR3 Device must be powered down and then restarted through the specialized initialization sequence before normal operation can continue.

8.2.1 Recommended DC Operating Conditions

8.2.1.1 Recommended DC Operating Conditions

Symbol	Voltage			DRAM	Unit
	Min	Typ	Max		
VDD1	1.70	1.80	1.95	Core Power1	V
VDD2	1.14	1.20	1.30	Core Power2	V
VDDCA	1.14	1.20	1.30	Input Buffer Power	V
VDDQ	1.14	1.20	1.30	I/O Buffer Power	V

Notes:

- VDD1 uses significantly less power than VDD2.
- The voltage range is for DC voltage only. DC is defined as the voltage supplied at the DRAM and is inclusive of all noise up to 1MHz at the DRAM pin.
- All parts list in section 3 order information table will not guarantee to meet functional and AC specification if the DC operation conditions out of range mentioned in above table.



8.2.2 Input Leakage Current

Parameter/Condition	Symbol	Min	Max	Unit	Notes
Input Leakage current	IL	-2	2	μA	1, 2
VREF supply leakage current	IVREF	-1	1	μA	3, 4

Notes:

- For CA, CE, CS_n, CK_t, CK_c. Any input $0V \leq V_{IN} \leq V_{DDCA}$. (All other pins not under test = 0V)
- Although DM is for input only, the DM leakage shall match the DQ and DQS_t/DQS_c output leakage specification.
- The minimum limit requirement is for testing purposes. The leakage current on VREFCA and VREFDQ pins should be minimal.
- $V_{REFDQ} = V_{DDQ}/2$ or $V_{REFCA} = V_{DDCA}/2$. (All other pins not under test = 0V)

8.2.3 Operating Temperature Range

Parameter/Condition	Symbol	Min	Max	Unit
Standard	TOPER	-40	85	°C
Extended		85	105	°C

Notes:

- Operating Temperature is the case surface temperature on the center-top side of the LPDDR3 device. For the measurement conditions, please refer to JESD51-2 standard.
- Some applications require operation of LPDDR3 in the maximum temperature conditions in the Extended Temperature Range between 85°C and 105°C. For LPDDR3 devices, some derating is necessary to operate in this range. See **MR4_Device Temperature (MA[7:0] = 04H)** table.
- Either the device operating temperature or the temperature sensor (See section 7.4.12.1 “**Temperature Sensor**”) may be used to set an appropriate refresh rate, determine the need for AC timing de-rating and/or monitor the operating temperature. When using the temperature sensor, the actual device case temperature may be higher than the TOPER rating that applies for the Standard or Extended Temperature Ranges. For example, TCASE may be above 85°C when the temperature sensor indicates a temperature of less than 85°C.
- All parts list in section 3 order information table will not guarantee to meet functional and AC specification if operating temperature out of the [range in order information table](#).

8.2.4 AC and DC Input Measurement Levels

8.2.4.1 AC and DC Logic Input Levels for Single-Ended Signals

8.2.4.1.1 Single-Ended AC and DC Input Levels for CA and CS_n Inputs

Symbol	Parameter	1600		1866/2133		Unit	Notes
		Min	Max	Min	Max		
$V_{IHCA}(AC)$	AC input logic high	$V_{REF} + 0.150$	Note 2	$V_{REF} + 0.135$	Note 2	V	1, 2
$V_{ILCA}(AC)$	AC input logic low	Note 2	$V_{ref} - 0.150$	Note 2	$V_{REF} - 0.135$	V	1, 2
$V_{IHCA}(DC)$	DC input logic high	$V_{REF} + 0.100$	V_{DDCA}	$V_{REF} + 0.100$	V_{DDCA}	V	1
$V_{ILCA}(DC)$	DC input logic low	VSS	$V_{REF} - 0.100$	VSS	$V_{REF} - 0.100$	V	1
$V_{REFCA}(DC)$	Reference Voltage for CA and CS_n inputs	$0.49 * V_{DDCA}$	$0.51 * V_{DDCA}$	$0.49 * V_{DDCA}$	$0.51 * V_{DDCA}$	V	3, 4

Notes:

- For CA and CS_n input only pins. $V_{REF} = V_{REFCA}(DC)$.
- See section 8.2.5.5 “**Overshoot and Undershoot Specifications**”.
- The ac peak noise on VREFCA may not allow VREFCA to deviate from VREFCA(DC) by more than $\pm 1\% V_{DDCA}$ (for reference: approx. ± 12 mV).
- For reference: approx. $V_{DDCA}/2 \pm 12$ mV.



8.2.4.1.2 Single-Ended AC and DC Input Levels for CKE

Symbol	Parameter	Min	Max	Unit	Note
V _{IHCKE}	CKE Input High Level	0.65 * VDDCA	Note 1	V	1
V _{ILCKE}	CKE Input Low Level	Note 1	0.35 * VDDCA	V	1

Note 1: See section 8.2.5.5 “Overshoot and Undershoot Specifications”.

8.2.4.1.3 Single-Ended AC and DC Input Levels for DQ and DM

Symbol	Parameter	1600		1866/2133		Unit	Notes
		Min	Max	Min	Max		
VIHDQ(AC)	AC input logic high	VREF + 0.150	Note 2	VREF + 0.135	Note 2	V	1, 2, 5
VILDQ(AC)	AC input logic low	Note 2	VREF - 0.150	Note 2	VREF - 0.135	V	1, 2, 5
VIHDQ(DC)	DC input logic high	VREF + 0.100	VDDQ	VREF + 0.100	VDDQ	V	1
VILDQ(DC)	DC input logic low	VSS	VREF - 0.100	VSS	VREF - 0.100	V	1
VREFDQ(DC) (DQ ODT disabled)	Reference Voltage for DQ, DM inputs	0.49 * VDDQ	0.51 * VDDQ	0.49 * VDDQ	0.51 * VDDQ	V	3, 4
VREFDQ(DC) (DQ ODT enabled)	Reference Voltage for DQ, DM inputs	VODTR/2 - 0.01 * VDDQ	VODTR/2 + 0.01 * VDDQ	VODTR/2 - 0.01 * VDDQ	VODTR/2 + 0.01 * VDDQ	V	3, 5, 6

Notes:

- For DQ input only pins. VREF = VREFDQ(DC).
- See section 8.2.5.5 “Overshoot and Undershoot Specifications”.
- The ac peak noise on VREFDQ may not allow VREFDQ to deviate from VREFDQ(DC) by more than $\pm 1\%$ VDDQ (for reference: approx. ± 12 mV).
- For reference: approx. VDDQ/2 ± 12 mV.
- For reference: approx. VODTR/2 ± 12 mV.
- The nominal mode register programmed value for RODT and the nominal controller output impedance RON are used for the calculation of VODTR. For testing purposes a controller RON value of 50 Ω is used.

$$VODTR = [(2 RON + RTT) / (RON + RTT)] \times VDDQ$$

8.2.4.2 VREF Tolerances

The dc-tolerance limits and ac-noise limits for the reference voltages VREFCA and VREFDQ are illustrated in below figure. It shows a valid reference voltage VREF(t) as a function of time. (VREF stands for VREFCA and VREFDQ likewise). VDD stands for VDDCA for VREFCA and VDDQ for VREFDQ. VREF(DC) is the linear average of VREF(t) over a very long period of time (e.g. 1 sec) and is specified as a fraction of the linear average of VDDQ or VDDCA also over a very long period of time (e.g. 1 sec). This average has to meet the min/max requirements in 8.2.4.1.1 “Single-Ended AC and DC Input Levels for CA and CS_n Inputs” table. Furthermore VREF(t) may temporarily deviate from VREF(DC) by no more than $\pm 1\%$ VDD. VREF(t) cannot track noise on VDDQ or VDDCA if this would send VREF outside these specifications.

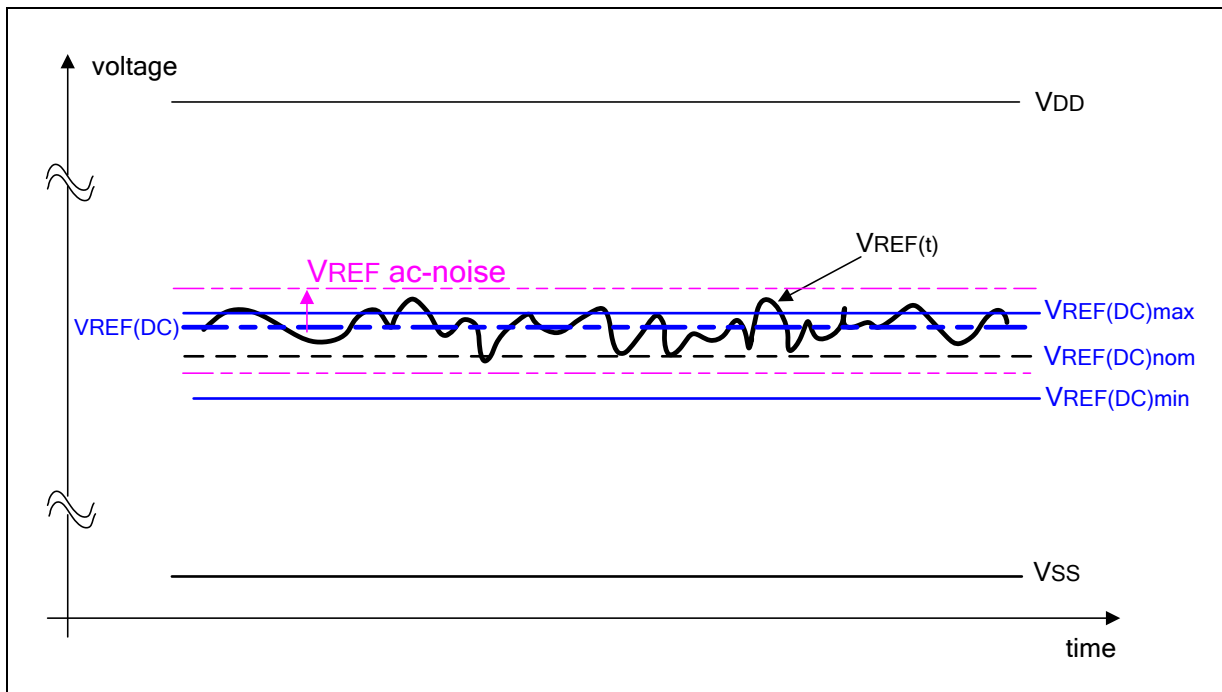

Figure 63 – Illustration of VREF(DC) tolerance and VREF ac-noise limits

The voltage levels for setup and hold time measurements $V_{IH}(AC)$, $V_{IH}(DC)$, $V_{IL}(AC)$ and $V_{IL}(DC)$ are dependent on VREF. “VREF” shall be understood as VREF(DC), as defined in above figure.

This clarifies that dc-variations of VREF affect the absolute voltage a signal has to reach to achieve a valid high or low level and therefore the time to which setup and hold is measured. System timing and voltage budgets need to account for VREF(DC) deviations from the optimum position within the data-eye of input signals.

This also clarifies that the LPDDR3 setup/hold specification and derating values need to include time and voltage associated with VREF ac-noise. Timing and voltage effects due to ac-noise on VREF up to the specified limit ($\pm 1\%$ of VDD) are included in LPDDR3 timings and their associated deratings.



8.2.4.3 Input Signal

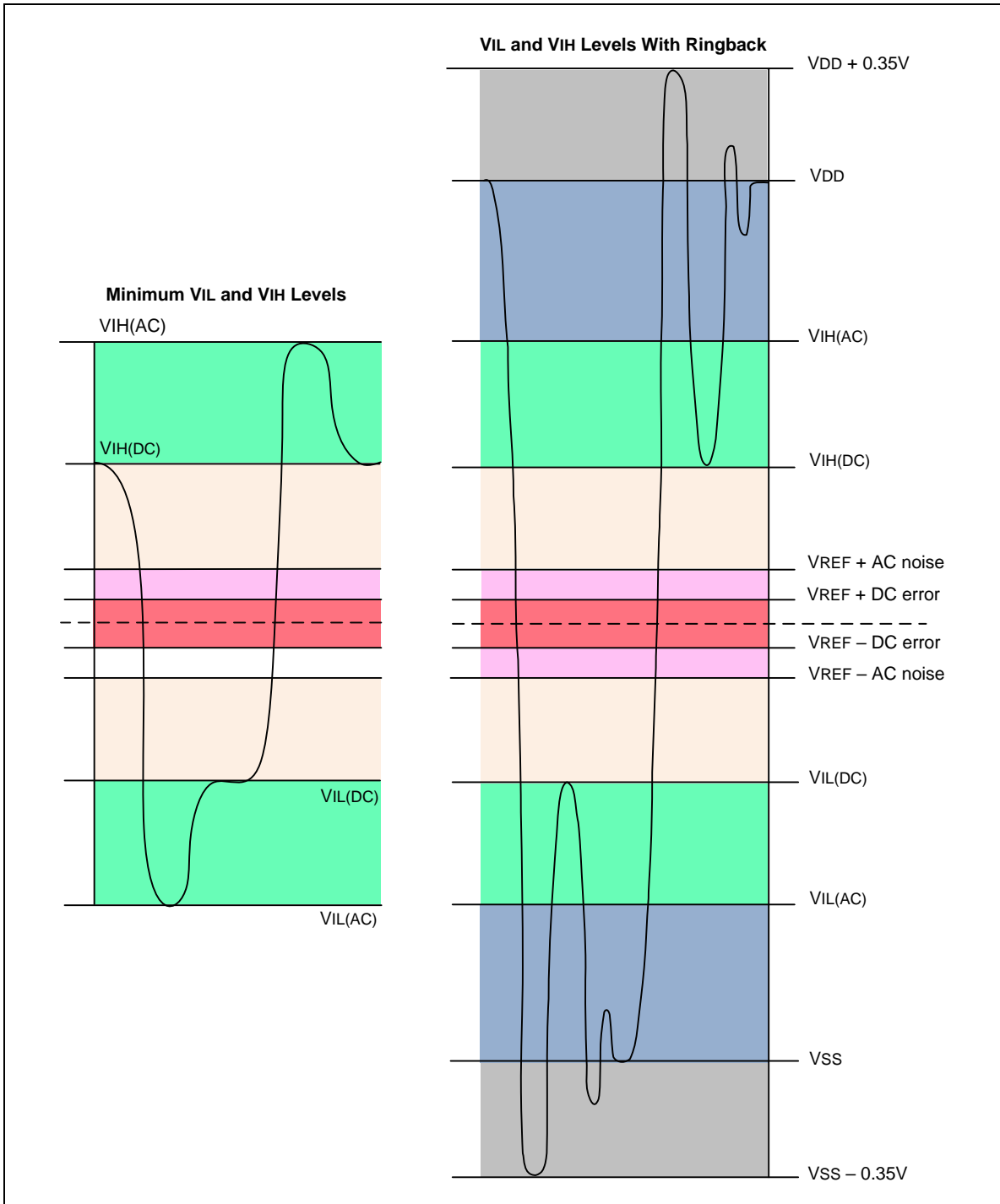

Figure 64 – LPDDR3 Input Signal

Notes:

1. Numbers reflect nominal values.
2. For CA0-9, CK_t, CK_c, and CS_n, VDD stands for VDDCA. For DQ, DM, DQS_t, and DQS_c, VDD stands for VDDQ.



8.2.4.4 AC and DC Logic Input Levels for Differential Signals

8.2.4.4.1 Differential Signal Definition

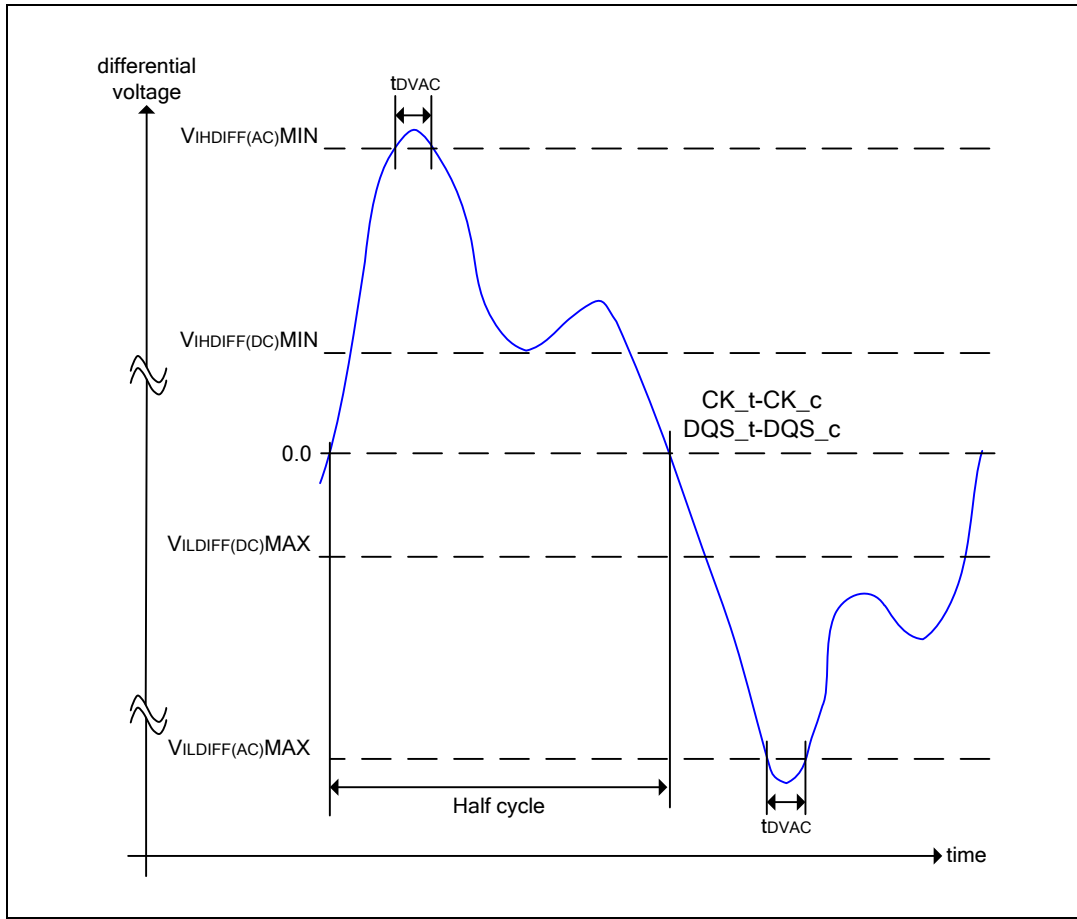

Figure 65 – Definition of Differential ac-swing and “time above ac-level” tDVAC

8.2.4.4.2 Differential swing requirements for clock (CK_t - CK_c) and strobe (DQS_t - DQS_c)

Differential AC and DC Input Levels

Symbol	Parameter	Value		Unit	Notes
		Min	Max		
$V_{IHdiff(dc)}$	Differential input high	$2 \times (V_{IH(dc)} - V_{REF})$	Note 3	V	1
$V_{ILdiff(dc)}$	Differential input logic low	Note 3	$2 \times (V_{IL(dc)} - V_{REF})$	V	1
$V_{IHdiff(ac)}$	Differential input high ac	$2 \times (V_{IH(ac)} - V_{REF})$	Note 3	V	2
$V_{ILdiff(ac)}$	Differential input low ac	Note 3	$2 \times (V_{IL(ac)} - V_{REF})$	V	2

Notes:

- Used to define a differential signal slew-rate. For CK_t - CK_c use $V_{IH}/V_{IL}(dc)$ of CA and V_{REFCA} ; for DQS_t - DQS_c, use $V_{IH}/V_{IL}(dc)$ of DQs and V_{REFDQ} ; if a reduced dc-high or dc-low level is used for a signal group, then the reduced level applies also here.
- For CK_t - CK_c use $V_{IH}/V_{IL}(ac)$ of CA and V_{REFCA} ; for DQS_t - DQS_c, use $V_{IH}/V_{IL}(ac)$ of DQs and V_{REFDQ} ; if a reduced ac-high or ac-low level is used for a signal group, then the reduced level applies also here.
- These values are not defined, however the single-ended signals CK_t, CK_c, DQS_t, and DQS_c need to be within the respective limits ($V_{IH}(dc)$ max, $V_{IL}(dc)$ min) for single-ended signals as well as the limitations for overshoot and undershoot. Refer to section 8.2.5.5 “Overshoot and Undershoot Specifications”.
- For CK_t and CK_c, $V_{REF} = V_{REFCA}(DC)$. For DQS_t and DQS_c, $V_{REF} = V_{REFDQ}(DC)$.



Allowed time before ringback t_{DVAC} for CK_t/CK_c and DQS_t/DQS_c

Slew Rate [V/nS]	t _{DVAC} [pS] @ V _{IH} /Ldiff(ac) = 300mV 1600Mbps		t _{DVAC} [pS] @ V _{IH} /Ldiff(ac) = 270mV 1866Mbps		t _{DVAC} [pS] @ V _{IH} /Ldiff(ac) = 270mV 2133Mbps	
	min	max	min	max	min	max
> 8.0	48	-	40	-	34	-
8.0	48	-	40	-	34	-
7.0	46	-	39	-	33	-
6.0	43	-	36	-	30	-
5.0	40	-	33	-	27	-
4.0	35	-	29	-	23	-
3.0	27	-	21	-	15	-
< 3.0	27	-	21	-	15	-

8.2.4.5 Single-ended requirements for differential signals

Each individual component of a differential signal (CK_t, DQS_t, CK_c, or DQS_c) has also to comply with certain requirements for single-ended signals.

CK_t and CK_c shall meet VSEH(ac)min / VSEL(ac)max in every half-cycle.

DQS_t, DQS_c shall meet VSEH(ac)min / VSEL(ac)max in every half-cycle preceding and following a valid transition.

Note that the applicable ac-levels for CA and DQ's are different per speed-bin.

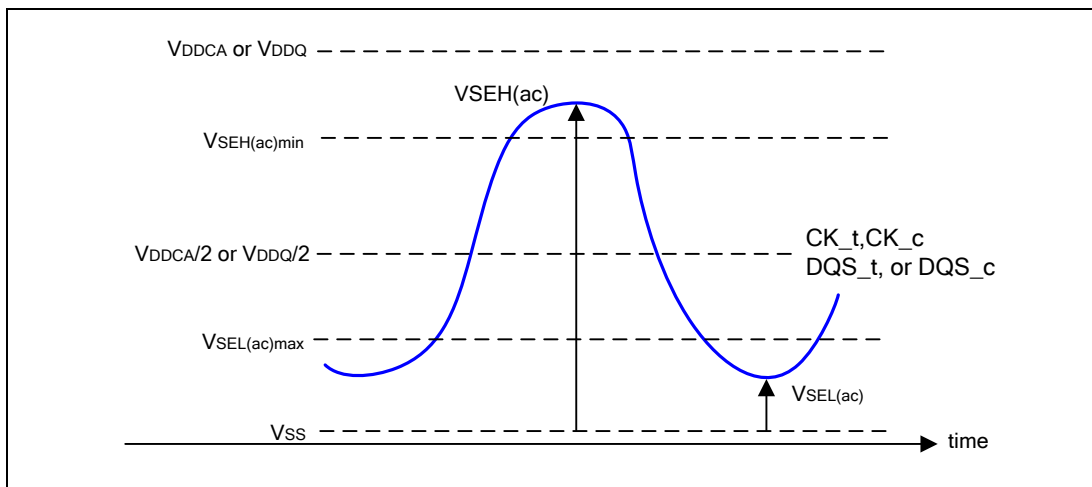

Figure 66 – Single-Ended Requirement for Differential Signals

Note that while CA and DQ signal requirements are with respect to VREF, the single-ended components of differential signals have a requirement with respect to VDDQ/2 for DQS_t, DQS_c and VDDCA/2 for CK_t, CK_c; this is nominally the same. The transition of single-ended signals through the ac-levels is used to measure setup time. For single-ended components of differential signals the requirement to reach VSEL(ac)max, VSEH(ac)min has no bearing on timing, but adds a restriction on the common mode characteristics of these signals.



The signal ended requirements for CK_t, CK_c, DQS_t and DQS_c are found in 8.2.4.1.1 “Single-Ended AC and DC Input Levels for CA and CS_n Inputs” table and 8.2.4.1.3 “Single-Ended AC and DC Input Levels for DQ and DM” table, respectively.

Table of Single-ended levels for CK_t, DQS_t, CK_c, DQS_c

Symbol	Parameter	Value		Unit	Notes
		Min	Max		
VSEH(AC150)	Single-ended high-level for strobes	$(V_{DDQ}/2) + 0.150$	Note 3	V	1, 2
	Single-ended high-level for CK_t, CK_c	$(V_{DDCA}/2) + 0.150$	Note 3	V	1, 2
VSEL(AC150)	Single-ended low-level for strobes	Note 3	$(V_{DDQ}/2) - 0.150$	V	1, 2
	Single-ended low-level for CK_t, CK_c	Note 3	$(V_{DDCA}/2) - 0.150$	V	1, 2
VSEH(AC135)	Single-ended high-level for strobes	$(V_{DDQ}/2) + 0.135$	Note 3	V	1, 2
	Single-ended high-level for CK_t, CK_c	$(V_{DDCA}/2) + 0.135$	Note 3	V	1, 2
VSEL(AC135)	Single-ended low-level for strobes	Note 3	$(V_{DDQ}/2) - 0.135$	V	1, 2
	Single-ended low-level for CK_t, CK_c	Note 3	$(V_{DDCA}/2) - 0.135$	V	1, 2

Notes:

1. For CK_t, CK_c use VSEH/VSEL(ac) of CA; for strobes (DQS0_t, DQS0_c, DQS1_t, DQS1_c, DQS2_t, DQS2_c, DQS3_t, DQS3_c) use VIH/VIL(ac) of DQs.
2. VIH(ac)/VIL(ac) for DQs is based on VREFDQ; VSEH(ac)/VSEL(ac) for CA is based on VREFCA; if a reduced ac-high or ac-low level is used for a signal group, then the reduced level applies also here.
3. These values are not defined, however the single-ended signals CK_t, CK_c, DQS0_t, DQS0_c, DQS1_t, DQS1_c, DQS2_t, DQS2_c, DQS3_t, DQS3_c need to be within the respective limits (VIH(dc) max, VIL(dc)min) for single-ended signals as well as the limitations for overshoot and undershoot. Refer to section 8.2.5.5 “Overshoot and Undershoot Specifications”.

8.2.4.6 Differential Input Cross Point Voltage

To guarantee tight setup and hold times as well as output skew parameters with respect to clock and strobe, each cross point voltage of differential input signals (CK_t, CK_c and DQS_t, DQS_c) must meet the requirements of above Single-ended levels for CK_t, DQS_t, CK_c, DQS_c table. The differential input cross point voltage Vix is measured from the actual cross point of true and complement signals to the midlevel between of VDD and VSS.

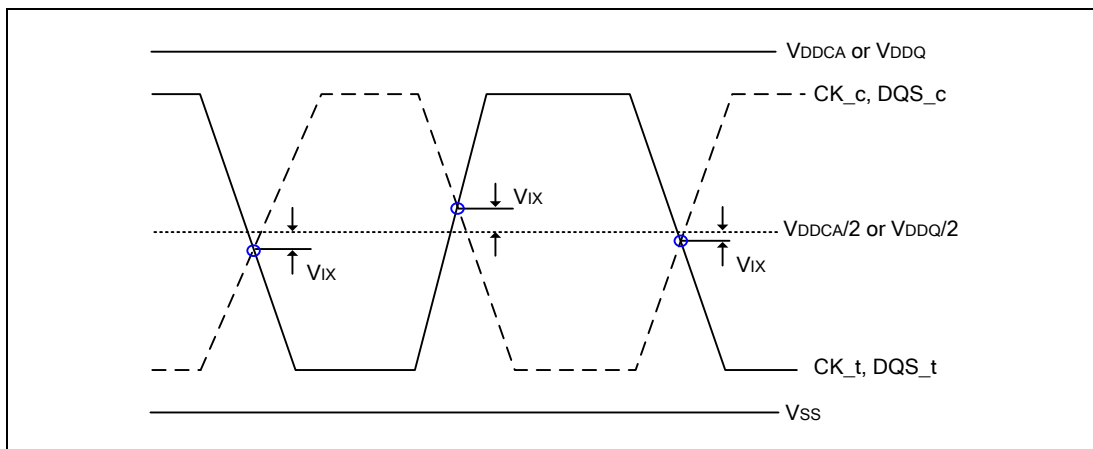

Figure 67 – VIX Definition



Table of Cross point voltage for differential input signals (CK, DQS)

Symbol	Parameter	Value		Unit	Notes
		Min	Max		
VIXCA	Differential Input Cross Point Voltage relative to VDDCA/2 for CK_t, CK_c	- 120	120	mV	1, 2
VIXDQ	Differential Input Cross Point Voltage relative to VDDQ/2 for DQS_t, DQS_c	- 120	120	mV	1, 2

Notes:

1. The typical value of VIX(AC) is expected to be about 0.5 × VDD of the transmitting device, and VIX(AC) is expected to track variations in VDD. VIX(AC) indicates the voltage at which differential input signals must cross.
2. For CK_t and CK_c, VREF = VREFCA(DC). For DQS_t and DQS_c, VREF = VREFDQ(DC).

8.2.4.7 Slew Rate Definitions for Single-Ended Input Signals

See section 8.8.2 “CA and CS_n Setup, Hold and Derating” for single-ended slew rate definitions for address and command signals.

See section 8.8.3 “Data Setup, Hold and Slew Rate Derating” for single-ended slew rate definitions for data signals.

8.2.4.8 Slew Rate Definitions for Differential Input Signals

Input slew rate for differential signals (CK_t, CK_c and DQS_t, DQS_c) are defined and measured as shown in below table and figure.

Table of Differential Input Slew Rate Definition

Description	Measured		Defined by
	from	to	
Differential input slew rate for rising edge (CK_t - CK_c and DQS_t - DQS_c).	VILdiffmax	VIHdiffmin	$[VIHdiffmin - VILdiffmax] / \Delta TRdiff$
Differential input slew rate for falling edge (CK_t - CK_c and DQS_t - DQS_c).	VIHdiffmin	VILdiffmax	$[VIHdiffmin - VILdiffmax] / \Delta TFdiff$

Note: The differential signal (i.e. CK_t - CK_c and DQS_t - DQS_c) must be linear between these thresholds.

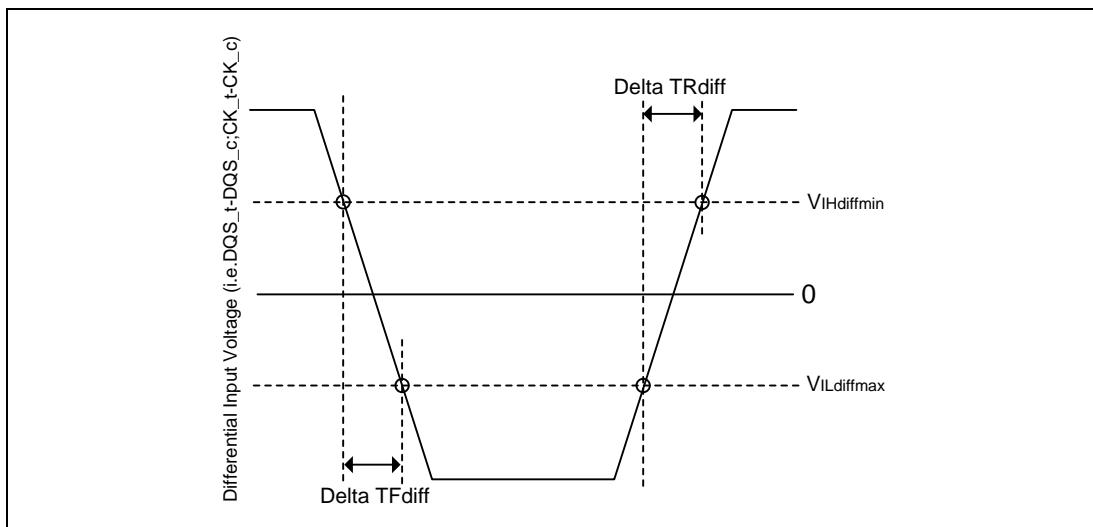

Figure 68 – Differential Input Slew Rate Definition for DQS_t, DQS_c and CK_t, CK_c



8.2.5 AC and DC Output Measurement Levels

8.2.5.1 Single Ended AC and DC Output Levels

Table of Single-Ended AC and DC Output Levels

Symbol	Parameter	Value		Unit	Notes
VOH(DC)	DC output high measurement level (for IV curve linearity)	0.9 x VDDQ		V	1
VOL(DC) ODT disabled	DC output low measurement level (for IV curve linearity)	0.1 x VDDQ		V	2
VOL(DC) ODT enabled	DC output low measurement level (for IV curve linearity)	$V_{DDQ} \times [0.1 + 0.9 \times (RON / (RTT + RON))]$		V	3
VOH(AC)	AC output high measurement level (for output slew rate)	VREFDQ + 0.12		V	
VOL(AC)	AC output low measurement level (for output slew rate)	VREFDQ - 0.12		V	
IOZ	Output Leakage current (DQ, DM, DQS_t, DQS_c) (DQ, DQS_t, DQS_c are disabled; $0V \leq V_{out} \leq V_{DDQ}$)	Min	-5	μA	
		Max	+5		
MM _{PUPD}	Delta RON between pull-up and pull-down for DQ/DM	Min	-15	%	
		Max	+15		

Notes:

1. IOH = -0.1mA.
2. IOL = +0.1mA.
3. The min value is derived when using RTT, min and RON,max ($\pm 30\%$ uncalibrated, $\pm 15\%$ calibrated).

8.2.5.2 Differential AC and DC Output Levels

Table of Differential AC and DC Output Levels of (DQS_t, DQS_c)

Symbol	Parameter	Value	Unit	Notes
VOH _{diff} (AC)	AC differential output high measurement level (for output SR)	+ 0.20 x VDDQ	V	1
VOL _{diff} (AC)	AC differential output low measurement level (for output SR)	- 0.20 x VDDQ	V	2

Notes:

1. IOH = -0.1mA.
2. IOL = +0.1mA.

8.2.5.3 Single Ended Output Slew Rate

With the reference load for timing measurements, output slew rate for falling and rising edges is defined and measured between VOL(AC) and VOH(AC) for single ended signals as shown in below table and figure.

Table of Single-Ended Output Slew Rate Definition

Description	Measured		Defined by
	from	to	
Single-ended output slew rate for rising edge	VOL(AC)	VOH(AC)	$[VOH(AC) - VOL(AC)] / \Delta t_{Rse}$
Single-ended output slew rate for falling edge	VOH(AC)	VOL(AC)	$[VOH(AC) - VOL(AC)] / \Delta t_{Fse}$
Note: Output slew rate is verified by design and characterization, and may not be subject to production test.			

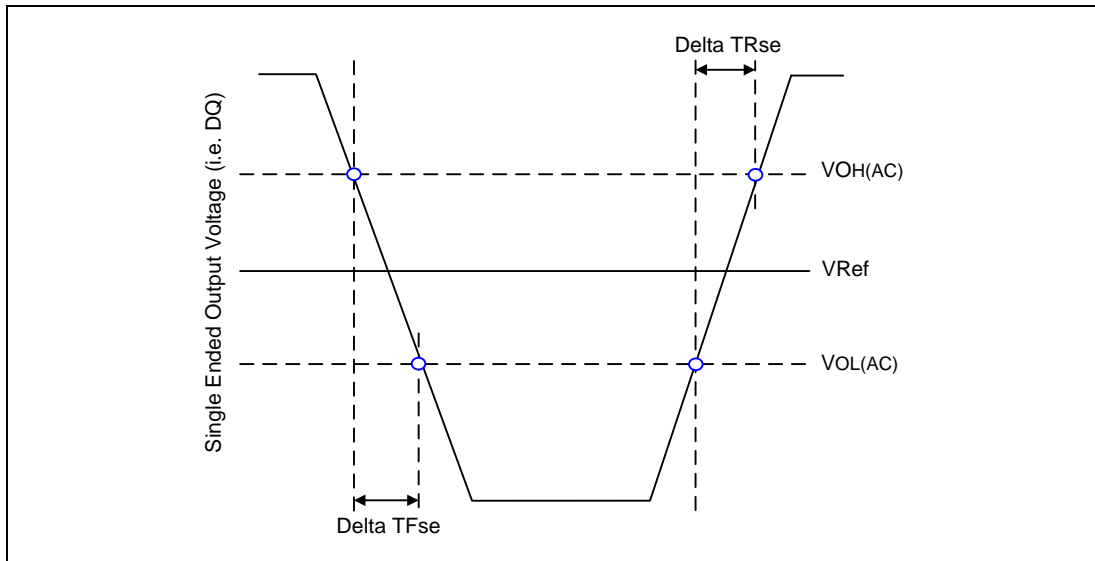

Figure 69 – Single Ended Output Slew Rate Definition

Table of Output Slew Rate (Single-Ended)

Parameter	Symbol	Value		Units
		Min ^{*1}	Max ^{*2}	
Single-ended Output Slew Rate (RON = 40Ω ± 30%)	SRQse	1.5	4.0	V/nS
Output slew-rate matching Ratio (Pull-up to Pull-down)		0.7	1.4	

Description:

SR: Slew Rate

Q: Query Output (like in DQ, which stands for Data-in, Query-Output)

se: Single-ended Signals

Notes:

1. Measured with output reference load.
2. The ratio of pull-up to pull-down slew rate is specified for the same temperature and voltage, over the entire temperature and voltage range. For a given output, it represents the maximum difference between pull-up and pull-down drivers due to process variation.
3. The output slew rate for falling and rising edges is defined and measured between VOL(AC) and VOH(AC).
4. Slew rates are measured under normal SSO conditions, with 50% of DQ signals per data byte switching.



8.2.5.4 Differential Output Slew Rate

With the reference load for timing measurements, output slew rate for falling and rising edges is defined and measured between VOLdiff(AC) and VOHdiff(AC) for differential signals as shown in below table and figure.

Table of Differential Output Slew Rate Definition

Description	Measured		Defined by
	from	to	
Differential output slew rate for rising edge	VOLdiff(AC)	VOHdiff(AC)	$[VOHdiff(AC) - VOLdiff(AC)] / \Delta TRdiff$
Differential output slew rate for falling edge	VOHdiff(AC)	VOLdiff(AC)	$[VOHdiff(AC) - VOLdiff(AC)] / \Delta TFdiff$

Note: Output slew rate is verified by design and characterization, and may not be subject to production test.

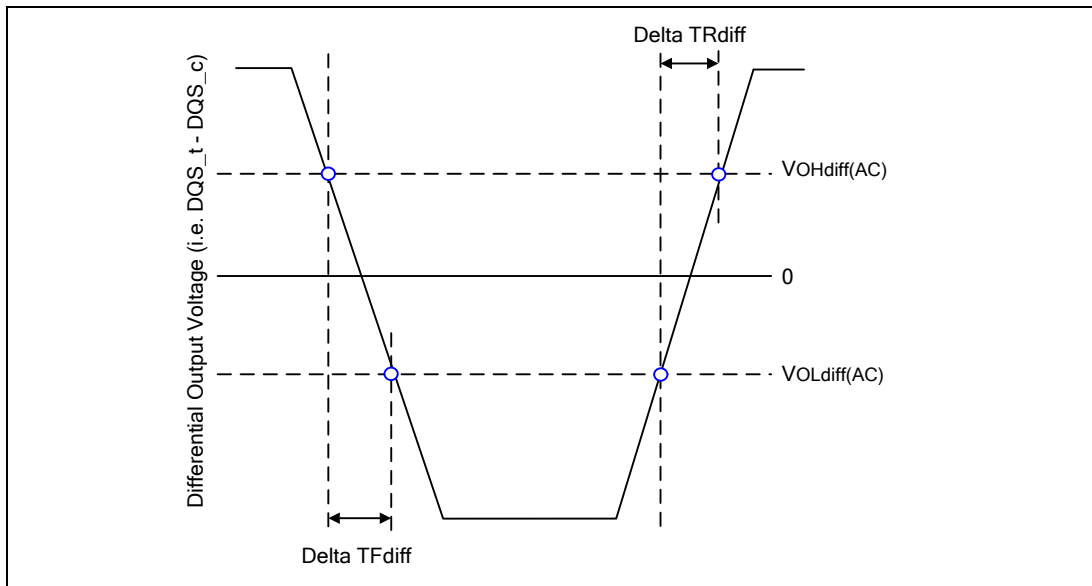

Figure 70 – Differential Output Slew Rate Definition

Table of Differential Output Slew Rate

Parameter	Symbol	Value		Units
		Min	Max	
Differential Output Slew Rate (RON = 40Ω ± 30%)	SRQdiff	3.0	8.0	V/nS

Description:

SR: Slew Rate

Q: Query Output (like in DQ, which stands for Data-in, Query-Output)

diff: Differential Signals

Notes:

1. Measured with output reference load.
2. The output slew rate for falling and rising edges is defined and measured between VOLdiff(AC) and VOHdiff(AC).
3. Slew rates are measured under normal SSO conditions, with 50% of DQ signals per data byte switching.



8.2.5.5 Overshoot and Undershoot Specifications

Table of AC Overshoot/Undershoot Specification

Parameter		1600	1866	2133	Unit
Maximum peak amplitude allowed for overshoot area. (See figure below)	Max	0.35			V
Maximum peak amplitude allowed for undershoot area. (See figure below)	Max	0.35			V
Maximum area above VDD. (See figure below)	Max	0.10			V-nS
Maximum area below VSS. (See figure below)	Max	0.10			V-nS

Notes:

1. VDD stands for VDDCA for CA[9:0], CK_t, CK_c, CS_n and CKE. VDD stands for VDDQ for DQ, DM, ODT, DQS_t and DQS_c.
2. Maximum peak amplitude values are referenced from actual VDD and VSS values.
3. Maximum area values are referenced from maximum operating VDD and VSS values.

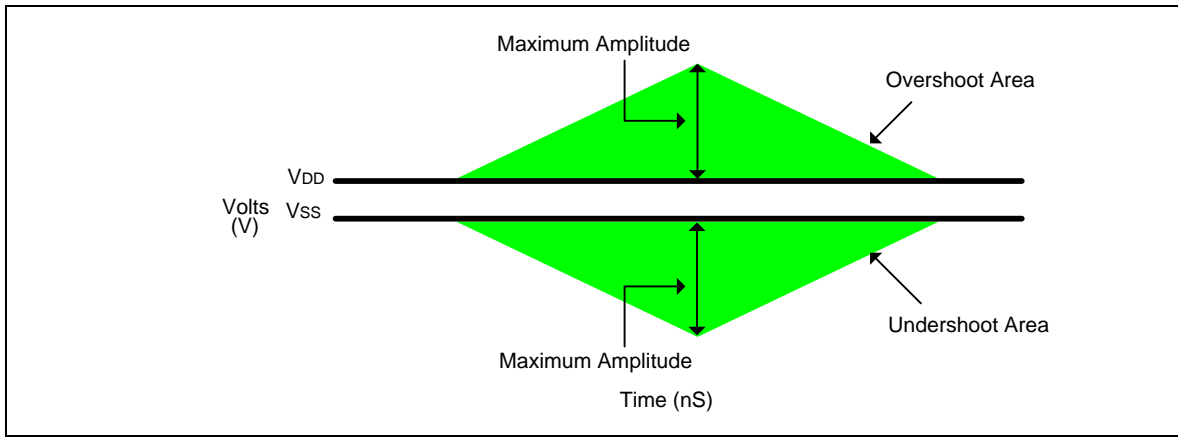

Figure 71 – Overshoot and Undershoot Definition

Notes:

1. VDD stands for VDDCA for CA[9:0], CK_t, CK_c, CS_n, and CKE. VDD stands for VDDQ for DQ, DM, ODT, DQS_t, and DQS_c.
2. Absolute maximum requirements apply.
3. Maximum peak amplitude values are referenced from actual VDD and VSS values.
4. Maximum area values are referenced from maximum operating VDD and VSS values.



8.2.6 Output buffer characteristics

8.2.6.1 HSUL_12 Driver Output Timing Reference Load

The timing reference loads are not intended as a precise representation of any particular system environment or a depiction of the actual load presented by a production tester. System designers should use IBIS or other simulation tools to correlate the timing reference load to a system environment. Manufacturers correlate to their production test conditions, generally one or more coaxial transmission lines terminated at the tester electronics.

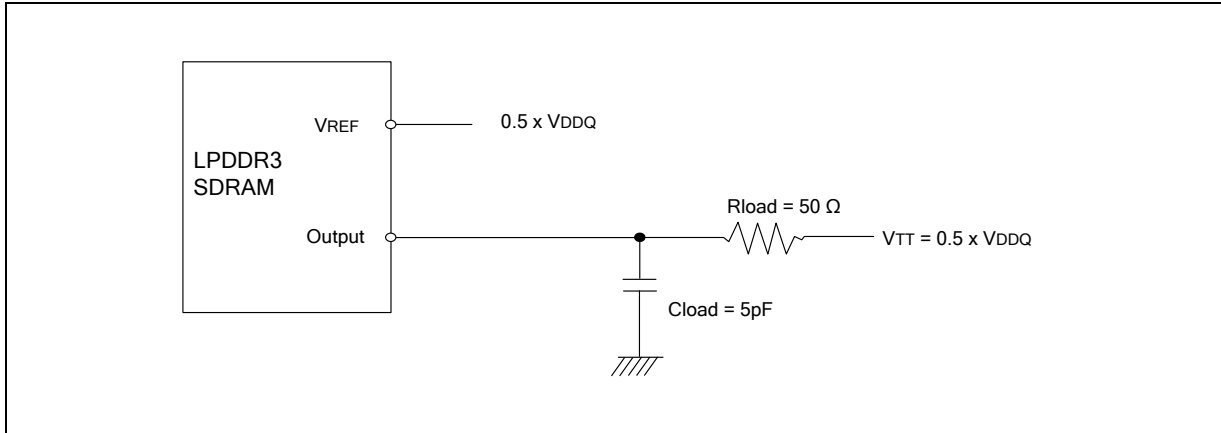

Figure 72 – HSUL_12 Driver Output Reference Load for Timing and Slew Rate

Note:

All output timing parameter values (like tDQ_{SCK}, tDQ_{SQ}, tQHS, tHZ, tRPRE etc.) are reported with respect to this reference load. This reference load is also used to report slew rate.

8.2.6.2 R_{ONPU} and R_{ONPD} Resistor Definition

$$R_{ONPU} = \frac{(V_{DDQ} - V_{out})}{ABS(I_{out})}$$

Note: This is under the condition that R_{ONPD} is turned off

$$R_{ONPD} = \frac{V_{out}}{ABS(I_{out})}$$

Note: This is under the condition that R_{ONPU} is turned off

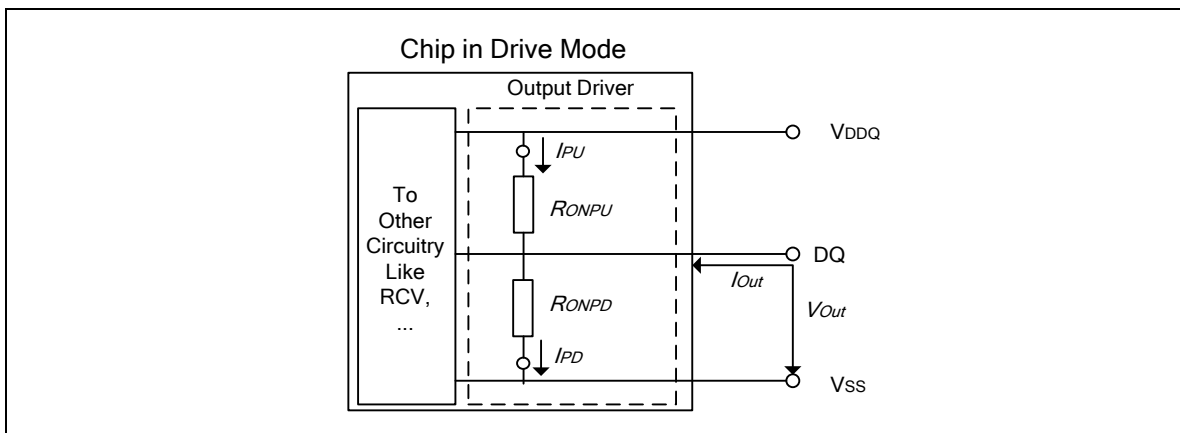

Figure 73 – Output Driver Definition of Voltages and Currents



8.2.6.3 R_{ONPU} and R_{ONPD} Characteristics with ZQ Calibration

Output driver impedance R_{ON} is defined by the value of the external reference resistor R_{ZQ} . Nominal R_{ZQ} is 240 Ω .

Table of Output Driver DC Electrical Characteristics with ZQ Calibration

$R_{ON,NOM}$	Resistor	Vout	Min	Nom	Max	Unit	Note
34.3 Ω	R_{ON34PD}	$0.5 \times V_{DDQ}$	0.85	1.00	1.15	$R_{zq}/7$	1, 2, 3, 4
	R_{ON34PU}	$0.5 \times V_{DDQ}$	0.85	1.00	1.15	$R_{zq}/7$	1, 2, 3, 4
40.0 Ω	R_{ON40PD}	$0.5 \times V_{DDQ}$	0.85	1.00	1.15	$R_{zq}/6$	1, 2, 3, 4
	R_{ON40PU}	$0.5 \times V_{DDQ}$	0.85	1.00	1.15	$R_{zq}/6$	1, 2, 3, 4
48.0 Ω	R_{ON48PD}	$0.5 \times V_{DDQ}$	0.85	1.00	1.15	$R_{zq}/5$	1, 2, 3, 4
	R_{ON48PU}	$0.5 \times V_{DDQ}$	0.85	1.00	1.15	$R_{zq}/5$	1, 2, 3, 4
60.0 Ω	R_{ON60PD}	$0.5 \times V_{DDQ}$	0.85	1.00	1.15	$R_{zq}/4$	1, 2, 3, 4
	R_{ON60PU}	$0.5 \times V_{DDQ}$	0.85	1.00	1.15	$R_{zq}/4$	1, 2, 3, 4
80.0 Ω	R_{ON80PD}	$0.5 \times V_{DDQ}$	0.85	1.00	1.15	$R_{zq}/3$	1, 2, 3, 4
	R_{ON80PU}	$0.5 \times V_{DDQ}$	0.85	1.00	1.15	$R_{zq}/3$	1, 2, 3, 4
Mismatch between pull-up and pull-down	MM_{PUPD}		-15.00		+15.00	%	1, 2, 3, 4, 5

Notes:

1. Across entire operating temperature range, after calibration.
2. $R_{ZQ} = 240\Omega$.
3. The tolerance limits are specified after calibration with fixed voltage and temperature. For behavior of the tolerance limits if temperature or voltage changes after calibration, see following section on voltage and temperature sensitivity.
4. Pull-down and pull-up output driver impedances are recommended to be calibrated at $0.5 \times V_{DDQ}$.
5. Measurement definition for mismatch between pull-up and pull-down: MM_{PUPD} : Measure R_{ONPU} and R_{ONPD} , both at $0.5 \times V_{DDQ}$:

$$MM_{PUPD} = \frac{R_{ONPU} - R_{ONPD}}{R_{ONNOM}} \times 100$$

For example, with $MM_{PUPD(max)} = 15\%$ and $R_{ONPD} = 0.85$, R_{ONPU} must be less than 1.0.

6. Output driver strength measured without ODT.

8.2.6.4 Output Driver Temperature and Voltage Sensitivity

If temperature and/or voltage change after calibration, the tolerance limits widen according to the tables shown below.

Table of Output Driver Sensitivity Definition

Resistor	Vout	Min	Max	Unit	Notes
R_{ONPD}	$0.5 \times V_{DDQ}$	$85 - (dR_{ONdT} \times \Delta T) - (dR_{ONdV} \times \Delta V)$	$115 + (dR_{ONdT} \times \Delta T) + (dR_{ONdV} \times \Delta V)$	%	1, 2
R_{ONPU}					
R_{TT}	$0.5 \times V_{DDQ}$	$85 - (dR_{TTdT} \times \Delta T) - (dR_{TTdV} \times \Delta V)$	$115 + (dR_{TTdT} \times \Delta T) + (dR_{TTdV} \times \Delta V)$	%	1, 2

Notes:

1. $\Delta T = T - T(@\text{calibration})$, $\Delta V = V - V(@\text{calibration})$.
2. dR_{ONdT} and dR_{ONdV} , dR_{TTdV} and dR_{TTdT} are not subject to production test but are verified by design and characterization.

Table of Output Driver Temperature and Voltage Sensitivity

Symbol	Parameter	Min	Max	Unit
dR_{ONdT}	R_{ON} Temperature Sensitivity	0.00	0.75	% / $^{\circ}\text{C}$
dR_{ONdV}	R_{ON} Voltage Sensitivity	0.00	0.20	% / mV
dR_{TTdT}	R_{TT} Temperature Sensitivity	0.00	0.75	% / $^{\circ}\text{C}$
dR_{TTdV}	R_{TT} Voltage Sensitivity	0.00	0.20	% / mV



8.2.6.5 R_{ONPU} and R_{ONPD} Characteristics without ZQ Calibration

Output driver impedance R_{ON} is defined by design and characterization as default setting.

Table of Output Driver DC Electrical Characteristics without ZQ Calibration

$R_{ON,NOM}$	Resistor	Vout	Min	Nom	Max	Unit	Note
34.3 Ω	R_{ON34PD}	0.5 x V_{DDQ}	24	34.3	44.6	Ω	1
	R_{ON34PU}	0.5 x V_{DDQ}	24	34.3	44.6	Ω	1
40.0 Ω	R_{ON40PD}	0.5 x V_{DDQ}	28	40	52	Ω	1
	R_{ON40PU}	0.5 x V_{DDQ}	28	40	52	Ω	1
48.0 Ω	R_{ON48PD}	0.5 x V_{DDQ}	33.6	48	62.4	Ω	1
	R_{ON48PU}	0.5 x V_{DDQ}	33.6	48	62.4	Ω	1
60.0 Ω	R_{ON60PD}	0.5 x V_{DDQ}	42	60	78	Ω	1
	R_{ON60PU}	0.5 x V_{DDQ}	42	60	78	Ω	1
80.0 Ω	R_{ON80PD}	0.5 x V_{DDQ}	56	80	104	Ω	1
	R_{ON80PU}	0.5 x V_{DDQ}	56	80	104	Ω	1

Note 1: Across entire operating temperature range, without calibration.

8.2.6.6 R_{ZQ} I-V CurveTable of R_{ZQ} I-V Curve

Voltage[V]	$R_{ON} = 240\Omega (R_{ZQ})$							
	Pull-Down				Pull-Up			
	Current [mA] / R_{ON} [Ohms]				Current [mA] / R_{ON} [Ohms]			
	default value after ZQReset		With Calibration		default value after ZQReset		With Calibration	
	Min	Max	Min	Max	Min	Max	Min	Max
	[mA]	[mA]	[mA]	[mA]	[mA]	[mA]	[mA]	[mA]
0.00	0.00	0.00	n/a	n/a	0.00	0.00	n/a	n/a
0.05	0.17	0.35	n/a	n/a	-0.17	-0.35	n/a	n/a
0.10	0.34	0.70	n/a	n/a	-0.34	-0.70	n/a	n/a
0.15	0.50	1.03	n/a	n/a	-0.50	-1.03	n/a	n/a
0.20	0.67	1.39	n/a	n/a	-0.67	-1.39	n/a	n/a
0.25	0.83	1.73	n/a	n/a	-0.83	-1.73	n/a	n/a
0.30	0.97	2.05	n/a	n/a	-0.97	-2.05	n/a	n/a
0.35	1.13	2.39	n/a	n/a	-1.13	-2.39	n/a	n/a
0.40	1.26	2.71	n/a	n/a	-1.26	-2.71	n/a	n/a
0.45	1.39	3.01	n/a	n/a	-1.39	-3.01	n/a	n/a
0.50	1.51	3.32	n/a	n/a	-1.51	-3.32	n/a	n/a
0.55	1.63	3.63	n/a	n/a	-1.63	-3.63	n/a	n/a
0.60	1.73	3.93	2.17	2.94	-1.73	-3.93	-2.17	-2.94
0.65	1.82	4.21	n/a	n/a	-1.82	-4.21	n/a	n/a
0.70	1.90	4.49	n/a	n/a	-1.90	-4.49	n/a	n/a
0.75	1.97	4.74	n/a	n/a	-1.97	-4.74	n/a	n/a
0.80	2.03	4.99	n/a	n/a	-2.03	-4.99	n/a	n/a
0.85	2.07	5.21	n/a	n/a	-2.07	-5.21	n/a	n/a
0.90	2.11	5.41	n/a	n/a	-2.11	-5.41	n/a	n/a
0.95	2.13	5.59	n/a	n/a	-2.13	-5.59	n/a	n/a
1.00	2.17	5.72	n/a	n/a	-2.17	-5.72	n/a	n/a
1.05	2.19	5.84	n/a	n/a	-2.19	-5.84	n/a	n/a
1.10	2.21	5.95	n/a	n/a	-2.21	-5.95	n/a	n/a
1.15	2.23	6.03	n/a	n/a	-2.23	-6.03	n/a	n/a
1.20	2.25	6.11	n/a	n/a	-2.25	-6.11	n/a	n/a

Note: The I-V curve of R_{ZQ} is not tested.

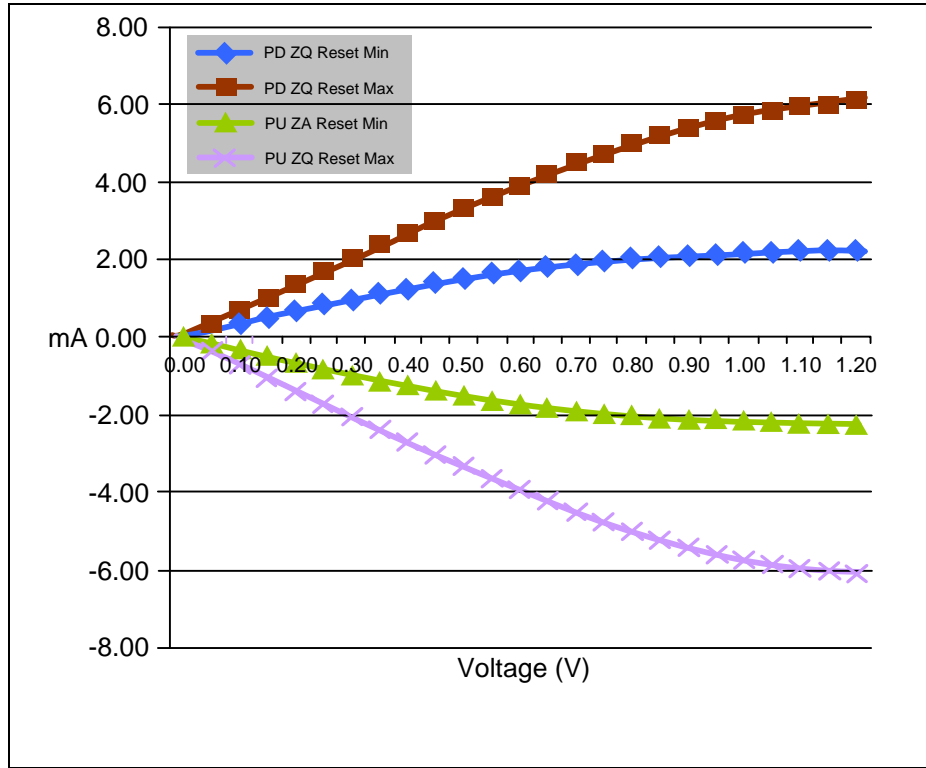

Figure 74 – I-V Curve after ZQ Reset

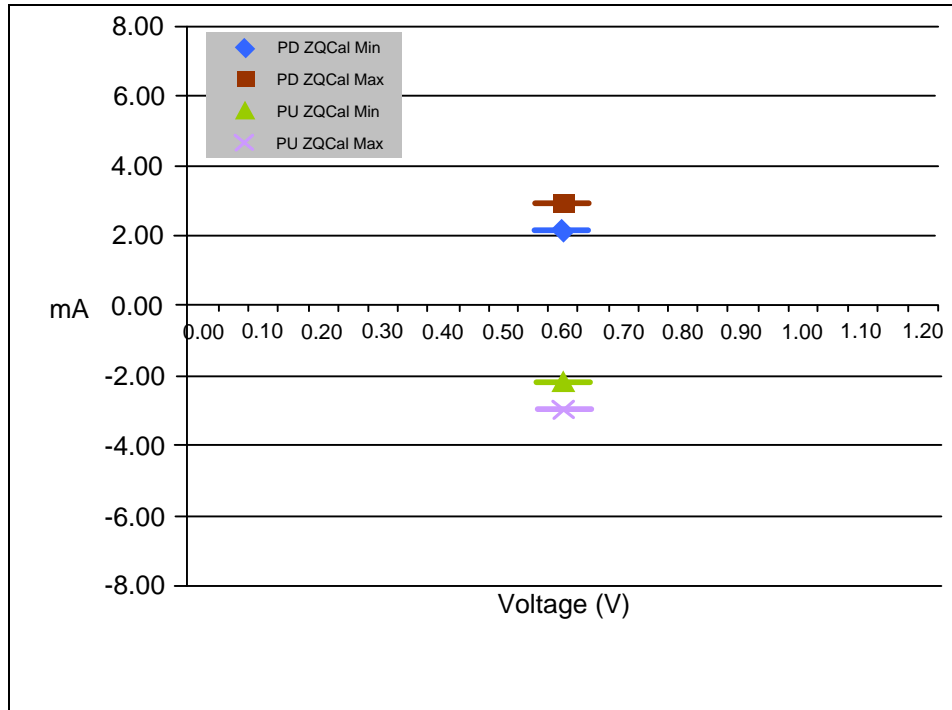

Figure 75 – I-V Curve after Calibration



8.2.6.7 ODT Levels and I-V Characteristics

On-Die Termination effective resistance, R_{TT} , is defined by mode register MR11[1:0]. ODT is applied to the DQ, DM, and DQS_t/DQS_c pins. A functional representation of the on-die termination is shown in the figure below.

R_{TT} is defined by the following formula:

$$R_{TTPU} = (V_{DDQ} - V_{Out}) / |I_{Out}|$$

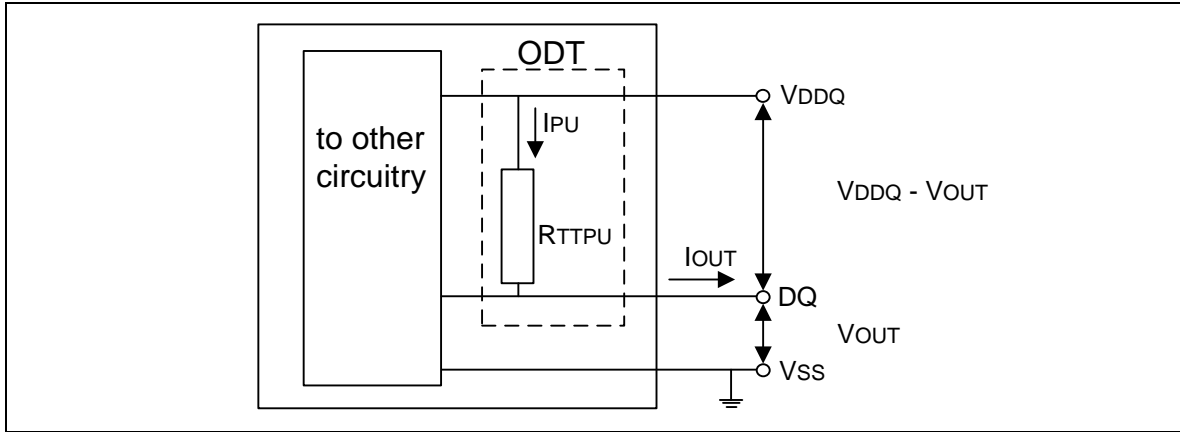

Figure 76 –Functional representation of On-Die Termination

Table of ODT DC Electrical Characteristics, assuming $R_{ZQ} = 240$ ohm after proper ZQ calibration

R_{TT} (ohm)	V_{OUT} (V)	I_{OUT}	
		Min(mA)	Max(mA)
$R_{ZQ}/1$	0.6	-2.17	-2.94
$R_{ZQ}/2$	0.6	-4.34	-5.88
$R_{ZQ}/4$	0.6	-8.68	-11.76



8.3 Input/Output Capacitance

Table of Input/Output Capacitance

Parameter	Symbol	Min	Max	Units	Note
Input capacitance, CK_t and CK_c	CCK	0.5	1.2	pF	1, 2
Input capacitance delta, CK_t and CK_c	CDCK	0	0.15	pF	1, 2, 3
Input capacitance, all other input-only pins	CI	0.5	1.1	pF	1, 2, 4
Input capacitance delta, all other input-only pins	CDI	-0.2	0.2	pF	1, 2, 5
Input/output capacitance, DQ, DM, DQS_t, DQS_c	CIO	1.0	1.8	pF	1, 2, 6, 7
Input/output capacitance delta, DQS_t, DQS_c	CDDQS	0	0.2	pF	1, 2, 7, 8
Input/output capacitance delta, DQ, DM	CDIO	-0.25	0.25	pF	1, 2, 7, 9
Input/output capacitance, ZQ Pin	CZQ	0	2.0	pF	1, 2

Notes:

1. This parameter applies to die device only (does not include package capacitance).
2. This parameter is not subject to production test. It is verified by design and characterization. The capacitance is measured according to JEP147 (Procedure for measuring input capacitance using a vector network analyzer (VNA) with VDD1, VDD2, VDDQ, VSS applied and all other pins floating).
3. Absolute value of CCK_t - CCK_c.
4. CI applies to CS_n, CKE, CA0-CA9, ODT
5. $CDI = CI - 0.5 * (CCK_t + CCK_c)$.
6. DM loading matches DQ and DQS.
7. MR3 I/O configuration DS OP3-OP0 = 0001b (34.3 Ω typical).
8. Absolute value of CDQS_t and CDQS_c.
9. $CDIO = CIO - 0.5 * (CDQS_t + CDQS_c)$ in byte lane.



8.4 IDD Specification Parameters and Test Conditions

8.4.1 IDD Measurement Conditions

The following definitions are used within the IDD measurement tables unless stated otherwise:

LOW: $V_{IN} \leq V_{IL(DC)} \text{ MAX}$

HIGH: $V_{IN} \geq V_{IH(DC)} \text{ MIN}$

STABLE: Inputs are stable at a HIGH or LOW level

SWITCHING: See tables below.

Table of Definition of Switching for CA Input Signals

Switching for CA								
	CK_t (RISING) / CK_c (FALLING)	CK_t (FALLING) / CK_c (RISING)	CK_t (RISING) / CK_c (FALLING)	CK_t (FALLING) / CK_c (RISING)	CK_t (RISING) / CK_c (FALLING)	CK_t (FALLING) / CK_c (RISING)	CK_t (RISING) / CK_c (FALLING)	CK_t (FALLING) / CK_c (RISING)
Cycle	N		N+1		N+2		N+3	
CS_n	HIGH		HIGH		HIGH		HIGH	
CA0	HIGH	LOW	LOW	LOW	LOW	HIGH	HIGH	HIGH
CA1	HIGH	HIGH	HIGH	LOW	LOW	LOW	LOW	HIGH
CA2	HIGH	LOW	LOW	LOW	LOW	HIGH	HIGH	HIGH
CA3	HIGH	HIGH	HIGH	LOW	LOW	LOW	LOW	HIGH
CA4	HIGH	LOW	LOW	LOW	LOW	HIGH	HIGH	HIGH
CA5	HIGH	HIGH	HIGH	LOW	LOW	LOW	LOW	HIGH
CA6	HIGH	LOW	LOW	LOW	LOW	HIGH	HIGH	HIGH
CA7	HIGH	HIGH	HIGH	LOW	LOW	LOW	LOW	HIGH
CA8	HIGH	LOW	LOW	LOW	LOW	HIGH	HIGH	HIGH
CA9	HIGH	HIGH	HIGH	LOW	LOW	LOW	LOW	HIGH

Notes:

1. CS_n must always be driven HIGH.
2. 50% of CA bus is changing between HIGH and LOW once per clock for the CA bus.
3. The above pattern (N, N+1, N+2, N+3...) is used continuously during IDD measurement for IDD values that require SWITCHING on the CA bus.



Table of Definition of Switching for IDD4R

Clock	CKE	CS_n	Clock Cycle Number	Command	CA0-CA2	CA3-CA9	All DQ
Rising	HIGH	LOW	N	Read_Rising	HLH	LHLHLHL	L
Falling	HIGH	LOW	N	Read_Falling	LLL	LLLLLLL	L
Rising	HIGH	HIGH	N + 1	NOP	LLL	LLLLLLL	H
Falling	HIGH	HIGH	N + 1	NOP	LLL	LLLLLLL	L
Rising	HIGH	HIGH	N + 2	NOP	LLL	LLLLLLL	H
Falling	HIGH	HIGH	N + 2	NOP	LLL	LLLLLLL	H
Rising	HIGH	HIGH	N + 3	NOP	LLL	LLLLLLL	H
Falling	HIGH	HIGH	N + 3	NOP	HLH	HLHLLHL	L
Rising	HIGH	LOW	N + 4	Read_Rising	HLH	HLHLLHL	H
Falling	HIGH	LOW	N + 4	Read_Falling	LHH	HHHHHHH	H
Rising	HIGH	HIGH	N + 5	NOP	HHH	HHHHHHH	H
Falling	HIGH	HIGH	N + 5	NOP	HHH	HHHHHHH	L
Rising	HIGH	HIGH	N + 6	NOP	HHH	HHHHHHH	L
Falling	HIGH	HIGH	N + 6	NOP	HHH	HHHHHHH	L
Rising	HIGH	HIGH	N + 7	NOP	HHH	HHHHHHH	H
Falling	HIGH	HIGH	N + 7	NOP	HLH	LHLHLHL	L

Notes:

1. Data strobe (DQS) is changing between HIGH and LOW every clock cycle.
2. The above pattern (N, N+1...) is used continuously during IDD measurement for IDD4R.

Table of Definition of Switching for IDD4W

Clock	CKE	CS_n	Clock Cycle Number	Command	CA0-CA2	CA3-CA9	All DQ
Rising	HIGH	LOW	N	Write_Rising	HLL	LHLHLHL	L
Falling	HIGH	LOW	N	Write_Falling	LLL	LLLLLLL	L
Rising	HIGH	HIGH	N + 1	NOP	LLL	LLLLLLL	H
Falling	HIGH	HIGH	N + 1	NOP	LLL	LLLLLLL	L
Rising	HIGH	HIGH	N + 2	NOP	LLL	LLLLLLL	H
Falling	HIGH	HIGH	N + 2	NOP	LLL	LLLLLLL	H
Rising	HIGH	HIGH	N + 3	NOP	LLL	LLLLLLL	H
Falling	HIGH	HIGH	N + 3	NOP	HLL	HLHLLHL	L
Rising	HIGH	LOW	N + 4	Write_Rising	HLL	HLHLLHL	H
Falling	HIGH	LOW	N + 4	Write_Falling	LHH	HHHHHHH	H
Rising	HIGH	HIGH	N + 5	NOP	HHH	HHHHHHH	H
Falling	HIGH	HIGH	N + 5	NOP	HHH	HHHHHHH	L
Rising	HIGH	HIGH	N + 6	NOP	HHH	HHHHHHH	L
Falling	HIGH	HIGH	N + 6	NOP	HHH	HHHHHHH	L
Rising	HIGH	HIGH	N + 7	NOP	HHH	HHHHHHH	H
Falling	HIGH	HIGH	N + 7	NOP	HLL	LHLHLHL	L

Notes:

1. Data strobe (DQS) is changing between HIGH and LOW every clock cycle.
2. Data masking (DM) must always be driven LOW.
3. The above pattern (N, N+1...) is used continuously during IDD measurement for IDD4W.



8.4.2 IDD Specifications

IDD values are for the entire operating voltage range, and all of them are for the entire standard range, with the exception of IDD6ET which is for the entire extended temperature range.

8.4.2.1 IDD Specification Parameters and Operating Conditions (85°C, x16, x32)

Notes: 1, 2, 3 apply for all values

Parameter/Condition	Symbol	Power Supply	800 MHz	933 MHz	1066 MHz	Unit	Notes
Operating one bank active-precharge current: tCK = tCKmin; tRC = tRCmin; CKE is HIGH; CS_n is HIGH between valid commands; CA bus inputs are switching; Data bus inputs are stable ODT disabled	IDD01	VDD1	7	7	7	mA	
	IDD02	VDD2	36	37	39	mA	
	IDD0,in	VDDCA VDDQ	8	8	8	mA	3
Idle power-down standby current: tCK = tCKmin; CKE is LOW; CS_n is HIGH; All banks are idle; CA bus inputs are switching; Data bus inputs are stable ODT disabled	IDD2P1	VDD1	0.2	0.2	0.2	mA	
	IDD2P2	VDD2	2	2	2	mA	
	IDD2P,in	VDDCA VDDQ	50	50	50	μA	3
Idle power-down standby current with clock stop: CK_t = LOW, CK_c = HIGH; CKE is LOW; CS_n is HIGH; All banks are idle; CA bus inputs are stable; Data bus inputs are stable ODT disabled	IDD2PS1	VDD1	0.2	0.2	0.2	mA	
	IDD2PS2	VDD2	2	2	2	mA	
	IDD2PS,in	VDDCA VDDQ	50	50	50	μA	3
Idle non power-down standby current: tCK = tCKmin; CKE is HIGH; CS_n is HIGH; All banks are idle; CA bus inputs are switching; Data bus inputs are stable ODT disabled	IDD2N1	VDD1	0.7	0.7	0.7	mA	
	IDD2N2	VDD2	9	10	11	mA	
	IDD2N,in	VDDCA VDDQ	8	8	8	mA	3
Idle non power-down standby current with clock stopped: CK_t = LOW, CK_c = HIGH; CKE is HIGH; CS_n is HIGH; All banks are idle; CA bus inputs are stable; Data bus inputs are stable ODT disabled	IDD2NS1	VDD1	0.7	0.7	0.7	mA	
	IDD2NS2	VDD2	4	4	4	mA	
	IDD2NS,in	VDDCA VDDQ	8	8	8	mA	3
Active power-down standby current: tCK = tCKmin; CKE is LOW; CS_n is HIGH; One bank is active; CA bus inputs are switching; Data bus inputs are stable ODT disabled	IDD3P1	VDD1	0.9	0.9	0.9	mA	
	IDD3P2	VDD2	5	5	5	mA	
	IDD3P,in	VDDCA VDDQ	50	50	50	μA	3



IDD Specification Parameters and Operating Conditions, (Continued)

Parameter/Condition	Symbol	Power Supply	800 MHz	933 MHz	1066 MHz	Unit	Notes
Active power-down standby current with clock stop: CK _t = LOW, CK _c = HIGH; CKE is LOW; CS _n is HIGH; One bank is active; CA bus inputs are stable; Data bus inputs are stable ODT disabled	IDD3PS1	VDD1	0.9	0.9	0.9	mA	
	IDD3PS2	VDD2	5	5	5	mA	
	IDD3PS,in	VDDCA VDDQ	50	50	50	μA	4
Active non power-down standby current: tCK = tCKmin; CKE is HIGH; CS _n is HIGH; One bank is active; CA bus inputs are switching; Data bus inputs are stable ODT disabled	IDD3N1	VDD1	1.1	1.1	1.1	mA	
	IDD3N2	VDD2	13	14	15	mA	
	IDD3N,in	VDDCA VDDQ	8	8	8	mA	4
Active non power-down standby current with clock stopped: CK _t = LOW, CK _c = HIGH; CKE is HIGH; CS _n is HIGH; One bank is active; CA bus inputs are stable; Data bus inputs are stable ODT disabled	IDD3NS1	VDD1	1.1	1.1	1.1	mA	
	IDD3NS2	VDD2	5	5	5	mA	
	IDD3NS,in	VDDCA VDDQ	8	8	8	mA	4
Operating burst READ current: tCK = tCKmin; CS _n is HIGH between valid commands; One bank is active; BL = 8; RL = RL (MIN); CA bus inputs are switching; 50% data change each burst transfer ODT disabled	IDD4R1	VDD1	1.3	1.3	1.3	mA	
	IDD4R2	VDD2	162	186	210	mA	
	IDD4R,in	VDDCA	8	8	8	mA	
Operating burst WRITE current: tCK = tCKmin; CS _n is HIGH between valid commands; One bank is active; BL = 8; WL = WLmin; CA bus inputs are switching; 50% data change each burst transfer ODT disabled	IDD4W1	VDD1	1.3	1.3	1.3	mA	
	IDD4W2	VDD2	163	189	215	mA	
	IDD4W,in	VDDCA VDDQ	34	34	34	mA	4
All-bank REFRESH burst current: tCK = tCKmin; CKE is HIGH between valid commands; tRC = tRFCabmin; Burst refresh; CA bus inputs are switching; Data bus inputs are stable ODT disabled	IDD51	VDD1	18	18	18	mA	
	IDD52	VDD2	60	62	63	mA	
	IDD5,in	VDDCA VDDQ	8	8	8	mA	4



IDD Specification Parameters and Operating Conditions, (Continued)

Parameter/Condition	Symbol	Power Supply	800 MHz	933 MHz	1066 MHz	Unit	Notes
All-bank REFRESH average current: tCK = tCKmin; CKE is HIGH between valid commands; tRC = RM x tREFI; CA bus inputs are switching; Data bus inputs are stable ODT disabled	IDD5AB1	VDD1	1.22	1.22	1.22	mA	
	IDD5AB2	VDD2	10.5	11	12	mA	
	IDD5AB,in	VDDCA VDDQ	8	8	8	mA	4
Per-bank REFRESH average current: tCK = tCKmin; CKE is HIGH between valid commands; tRC = RM x tREFI/8; CA bus inputs are switching; Data bus inputs are stable ODT disabled	IDD5PB1	VDD1	1.3	1.3	1.3	mA	
	IDD5PB2	VDD2	11	11	12	mA	
	IDD5PB,in	VDDCA VDDQ	8	8	8	mA	4
Deep power-down current: CK_t = LOW, CK_c = HIGH; CKE is LOW; CA bus inputs are stable; Data bus inputs are stable ODT disabled	IDD81	VDD1	50	50	50	μA	
	IDD82	VDD2	50	50	50	μA	
	IDD8,in	VDDCA VDDQ	50	50	50	μA	4

Notes:

1. Published IDD values are the maximum of the distribution of the arithmetic mean.
2. ODT disabled: MR11[2:0] = 000b.
3. IDD current specifications are tested after the device is properly initialized.
4. Measured currents are the summation of VDDQ and VDDCA.
5. For all IDD measurements, VIHCKE = 0.8 x VDDCA, VILCKE = 0.2 x VDDCA.



8.4.2.2 IDD6 Partial Array Self-Refresh Current (x16, x32)

Parameter		Symbol	Power Supply	85 °C	Condition	Unit
IDD6 Partial Array Self-Refresh Current	Full Array	IDD6 ₁	VDD1	600	Self refresh current CK_t=LOW, CK_c=HIGH; CKE is LOW; CA bus inputs are stable; Data bus inputs are stable; ODT disabled	μA
		IDD6 ₂	VDD2	3000		
		IDD6 _{IN}	VDDCA VDDQ	50		
	1/2 Array	IDD6 ₁	VDD1	500		μA
		IDD6 ₂	VDD2	2000		
		IDD6 _{IN}	VDDCA VDDQ	50		
	1/4 Array	IDD6 ₁	VDD1	400		μA
		IDD6 ₂	VDD2	1700		
		IDD6 _{IN}	VDDCA VDDQ	50		
	1/8 Array	IDD6 ₁	VDD1	300		μA
		IDD6 ₂	VDD2	1500		
		IDD6 _{IN}	VDDCA VDDQ	50		

Notes:

1. IDD6 currents are measured using bank-masking only.
2. IDD values published are the maximum of the distribution of the arithmetic mean.

8.5 Clock Specification

The jitter specified is a random jitter meeting a Gaussian distribution. Input clocks violating the min/max values may result in malfunction of the LPDDR3 device.

8.5.1 Definition for tCK(avg) and nCK

tCK(avg) is calculated as the average clock period across any consecutive 200 cycle window, where each clock period is calculated from rising edge to rising edge.

$$tCK(avg) = \left[\sum_{j=1}^N tCK_j \right] / N$$

where $N = 200$

Unit 'tCK(avg)' represents the actual clock average tCK(avg) of the input clock under operation. Unit 'nCK' represents one clock cycle of the input clock, counting the actual clock edges.

tCK(avg) may change by up to ± 1% within a 100 clock cycle window, provided that all jitter and timing specs are met.

8.5.2 Definition for tCK(abs)

tCK(abs) is defined as the absolute clock period, as measured from one rising edge to the next consecutive rising edge.

tCK(abs) is not subject to production test.



8.5.3 Definition for tCH(avg) and tCL(avg)

tCH(avg) is defined as the average high pulse width, as calculated across any consecutive 200 high pulses.

$$tCH(avg) = \left[\sum_{j=1}^N tCH_j \right] / (N \times tCK(avg))$$

where $N = 200$

tCL(avg) is defined as the average low pulse width, as calculated across any consecutive 200 low pulses.

$$tCL(avg) = \left[\sum_{j=1}^N tCL_j \right] / (N \times tCK(avg))$$

where $N = 200$

8.5.4 Definition for tJIT(per)

tJIT(per) is the single period jitter defined as the largest deviation of any signal tCK from tCK(avg).

tJIT(per) = Min/max of {tCK_i - tCK(avg) where i = 1 to 200}.

tJIT(per),act is the actual clock jitter for a given system.

tJIT(per),allowed is the specified allowed clock period jitter.

tJIT(per) is not subject to production test.

8.5.5 Definition for tJIT(cc)

tJIT(cc) is defined as the absolute difference in clock period between two consecutive clock cycles.

tJIT(cc) = Max of [{tCK_{i+1} - tCK_i}].

tJIT(cc) defines the cycle to cycle jitter.

tJIT(cc) is not subject to production test.

8.5.6 Definition for tERR(nper)

tERR(nper) is defined as the cumulative error across n multiple consecutive cycles from tCK(avg).

tERR(nper),act is the actual clock jitter over n cycles for a given system.

tERR(nper),allowed is the specified allowed clock period jitter over n cycles.

tERR(nper) is not subject to production test.

$$tERR(nper) = \left[\sum_{j=i}^{i+n-1} tCK_j \right] - n \times tCK(avg)$$

tERR(nper),min can be calculated by the formula shown below:

$$tERR(nper), min = (1 + 0.68LN(n)) \times tJIT(per), min$$

tERR(nper),max can be calculated by the formula shown below:

$$tERR(nper), max = (1 + 0.68LN(n)) \times tJIT(per), max$$

Using these equations, tERR(nper) tables can be generated for each tJIT(per),act value.



8.5.7 Definition for Duty Cycle Jitter tJIT(duty)

tJIT(duty) is defined with absolute and average specification of tCH / tCL.

$$tJIT(duty),min = MIN((tCH(abs),min - tCH(avg),min), (tCL(abs),min - tCL(avg),min)) \times tCK(avg)$$

$$tJIT(duty),max = MAX((tCH(abs),max - tCH(avg),max), (tCL(abs),max - tCL(avg),max)) \times tCK(avg)$$

8.5.8 Definition for tCK(abs), tCH(abs) and tCL(abs)

These parameters are specified per their average values, however it is understood that the following relationship between the average timing and the absolute instantaneous timing holds at all times.

Table of Definition for tCK(abs), tCH(abs), and tCL(abs)

Parameter	Symbol	Min	Unit
Absolute Clock Period	tCK(abs)	tCK(avg),min + tJIT(per),min	pS
Absolute Clock HIGH Pulse Width	tCH(abs)	tCH(avg),min + tJIT(duty),min / tCK(avg)min	tCK(avg)
Absolute Clock LOW Pulse Width	tCL(abs)	tCL(avg),min + tJIT(duty),min / tCK(avg)min	tCK(avg)

Notes:

1. tCK(avg),min is expressed in pS for this table.
2. tJIT(duty),min is a negative value.

8.6 Period Clock Jitter

LPDDR3 devices can tolerate some clock period jitter without core timing parameter de-rating. This section describes device timing requirements in the presence of clock period jitter (tJIT(per)) in excess of the values found in section 8.8.1 “LPDDR3 AC Timing

” table and how to determine cycle time de-rating and clock cycle de-rating.

8.6.1 Clock period jitter effects on core timing parameters (tRCD, tRP, tRTP, tWR, tWRA, tWTR, tRC, tRAS, tRRD, tFAW)

Core timing parameters extend across multiple clock cycles. Period clock jitter will impact these parameters when measured in numbers of clock cycles. When the device is operated with clock jitter within the specification limits, the LPDDR3 device is characterized and verified to support $tnPARAM = RU\{tPARAM / tCK(avg)\}$.

When the device is operated with clock jitter outside specification limits, the number of clocks or tCK(avg) may need to be increased based on the values for each core timing parameter.

8.6.1.1 Cycle time de-rating for core timing parameters

For a given number of clocks (tnPARAM), for each core timing parameter, average clock period (tCK(avg)) and actual cumulative period error (tERR(tnPARAM),act) in excess of the allowed cumulative period error (tERR(tnPARAM),allowed), the equation below calculates the amount of cycle time de-rating (in nS) required if the equation results in a positive value for a core timing parameter.

$$CycleTimeDerating = MAX\left\{\left(\frac{tnPARAM + tERR(tnPARAM),act - tERR(tnPARAM),allowed}{tnPARAM} - tCK(avg)\right), 0\right\}$$

A cycle time derating analysis should be conducted for each core timing parameter. The amount of cycle time derating required is the maximum of the cycle time de-ratings determined for each individual core timing parameter.



8.6.1.2 Clock cycle de-rating for core timing parameters

For a given number of clocks (t_{nPARAM}) for each core timing parameter, clock cycle de-rating should be specified with amount of period jitter ($t_{JIT(per)}$).

For a given number of clocks (t_{nPARAM}), for each core timing parameter, average clock period ($t_{CK(avg)}$) and actual cumulative period error ($t_{ERR}(t_{nPARAM},act)$) in excess of the allowed cumulative period error ($t_{ERR}(t_{nPARAM},allowed)$), the equation below calculates the clock cycle derating (in clocks) required if the equation results in a positive value for a core timing parameter.

$$ClockCycleDerating = RU \left\{ \frac{t_{PARAM} + t_{ERR}(t_{nPARAM},act) - t_{ERR}(t_{nPARAM},allowed)}{t_{CK(avg)}} \right\} - t_{nPARAM}$$

A clock cycle de-rating analysis should be conducted for each core timing parameter.

8.6.2 Clock jitter effects on Command/Address timing parameters (t_{ISCA} , t_{IHCA} , t_{ISCS} , t_{IHCS} , t_{ISCKE} , t_{IHCKE} , t_{ISb} , t_{IHb} , t_{ISCKEb} , t_{IHCKEb})

These parameters are measured from a command/address signal (CKE, CS, CA0 - CA9) transition edge to its respective clock signal (CK_t/CK_c) crossing. The spec values are not affected by the amount of clock jitter applied (i.e. $t_{JIT(per)}$), as the setup and hold are relative to the clock signal crossing that latches the command/address. Regardless of clock jitter values, these values shall be met.

8.6.3 Clock jitter effects on Read timing parameters

8.6.3.1 t_{RPRE}

When the device is operated with input clock jitter, t_{RPRE} needs to be de-rated by the actual period jitter ($t_{JIT(per),act,max}$) of the input clock in excess of the allowed period jitter ($t_{JIT(per),allowed,max}$). Output de-ratings are relative to the input clock.

$$t_{RPRE}(min, derated) = 0.9 - \left(\frac{t_{JIT(per),act,max} - t_{JIT(per),allowed,max}}{t_{CK(avg)}} \right)$$

For example,

if the measured jitter into a LPDDR3-1600 device has $t_{CK(avg)} = 1250$ pS, $t_{JIT(per),act,min} = -92$ pS and $t_{JIT(per),act,max} = +134$ pS, then

$$t_{RPRE,min,derated} = 0.9 - (t_{JIT(per),act,max} - t_{JIT(per),allowed,max})/t_{CK(avg)} = 0.9 - (134 - 100)/1250 = .8728 t_{CK(avg)}$$

8.6.3.2 $t_{LZ(DQ)}$, $t_{HZ(DQ)}$, t_{DQSCK} , $t_{LZ(DQS)}$, $t_{HZ(DQS)}$

These parameters are measured from a specific clock edge to a data signal (DM_n, DQ_m: n=0,1,2,3, m=0–31) transition and will be met with respect to that clock edge. Therefore, they are not affected by the amount of clock jitter applied (i.e. $t_{JIT(per)}$).

8.6.3.3 t_{QSH} , t_{QSL}

These parameters are affected by duty cycle jitter which is represented by $t_{CH(abs)min}$ and $t_{CL(abs)min}$.

These parameters determine absolute Data-Valid Window (DVW) at the LPDDR3 device pin.

Absolute min DVW @ LPDDR3 device pin=

$$\min \{ (t_{QSH(abs)min} - t_{DQSQmax}), (t_{QSL(abs)min} - t_{DQSQmax}) \}$$

This minimum DVW shall be met at the target frequency regardless of clock jitter.



8.6.3.4 tRPST

tRPST is affected by duty cycle jitter which is represented by tCL(abs). Therefore tRPST(abs)min can be specified by tCL(abs)min.

$$tRPST(abs)min = tCL(abs)min - 0.05 = tQSL(abs)min$$

8.6.4 Clock jitter effects on Write timing parameters

8.6.4.1 tDS, tDH

These parameters are measured from a data signal (DMn, DQm.: n=0,1,2,3, m=0-31) transition edge to its respective data strobe signal (DQSn_t, DQSn_c: n=0,1,2,3) crossing. The spec values are not affected by the amount of clock jitter applied (i.e. tJIT(per)), as the setup and hold are relative to the clock signal crossing that latches the data. Regardless of clock jitter values, these values shall be met.

8.6.4.2 tDSS, tDSH

These parameters are measured from a data strobe signal (DQSx_t, DQSx_c) crossing to its respective clock signal (CK_t/CK_c) crossing. The spec values are not affected by the amount of clock jitter applied (i.e. tJIT(per)), as the setup and hold of the data strobes are relative to the corresponding clock signal crossing. Regardless of clock jitter values, these values shall be met.

8.6.4.3 tDQSS

This parameter is measured from a data strobe signal (DQSx_t, DQSx_c) crossing to the subsequent clock signal (CK_t/CK_c) crossing. When the device is operated with input clock jitter, this parameter needs to be de-rated by the actual period jitter tJIT(per),act of the input clock in excess of the allowed period jitter tJIT(per),allowed.

$$tDQSS(min, derated) = 0.75 - \frac{tJIT(per), act, min - tJIT(per), allowed, min}{tCK(avg)}$$

$$tDQSS(max, derated) = 1.25 - \frac{tJIT(per), act, max - tJIT(per), allowed, max}{tCK(avg)}$$

For example,

If the measured jitter into a LPDDR3-1600 device has tCK(avg) = 1250 pS, tJIT(per),act,min = -93 pS and tJIT(per),act,max = + 134 pS, then

$$tDQSS,(min,derated) = 0.75 - (tJIT(per),act,min - tJIT(per),allowed,min)/tCK(avg) = 0.75 - (-93+ 100)/1250 = .7444 tCK(avg)$$

and

$$tDQSS,(max,derated) = 1.25 - (tJIT(per),act,max - tJIT(per),allowed,max)/tCK(avg) = 1.25 - (134 - 100)/1250 = 1.2228 tCK(avg)$$



8.7 Refresh Requirements

8.7.1 Refresh Requirement Parameters

Parameter	Symbol	1 Gb	Unit	
Number of Banks		8		
Refresh Window TCASE $\leq 85^{\circ}\text{C}$	tREFW	32	mS	
Refresh Window 1/2-Rate Refresh	tREFW	16	mS	
Refresh Window 1/4-Rate Refresh	tREFW	8	mS	
Required number of Refresh commands (min)	R	4,096		
Average time between Refresh commands (for reference only) TCASE $\leq 85^{\circ}\text{C}$	REFab	tREFI	7.8	μS
	REFpb	tREFIpb	0.975	μS
Refresh Cycle time	tRFCab	130	nS	
Per Bank Refresh Cycle time	tRFCpb	60	nS	

8.7.2 LPDDR3 Read and Write Latencies

Parameter	Value								Unit
Max. Clock Frequency	400	533	600	667	733	800	933	1066	MHz
Max. Data Rate	800	1066	1200	1333	1466	1600	1866	2133	MT/S
Average Clock Period	2.5	1.875	1.667	1.5	1.364	1.25	1.071	0.938	nS
Read Latency	6	8	9	10	11	12	14	16	tCK(avg)
Write Latency (Set A)	3	4	5	6	6	6	8	8	tCK(avg)



8.8 AC Timings

8.8.1 LPDDR3 AC Timing

(Notes 1, 2 and 3 apply to all parameters)

Parameter	Symbol	min / max	Data Rate			Unit
			1600	1866	2133	
Max. clock Frequency	fCK	-	800	933	1066	MHz
Clock Timing						
Average clock period	tCK(avg)	MIN	1.25	1.071	0.938	nS
		MAX	100			
Average HIGH pulse width	tCH(avg)	MIN	0.45			tCK(avg)
		MAX	0.55			
Average LOW pulse width	tCL(avg)	MIN	0.45			tCK(avg)
		MAX	0.55			
Absolute clock period	tCK(abs)	MIN	tCK(avg)min + tJIT(per)min			nS
Absolute clock HIGH pulse width	tCH(abs), allowed	MIN	0.43			tCK(avg)
		MAX	0.57			
Absolute clock LOW pulse width	tCL(abs), (allowed)	MIN	0.43			tCK(avg)
		MAX	0.57			
Clock Period Jitter (with supported jitter)	tJIT(per), (allowed)	MIN	-70	-60	-50	pS
		MAX	70	60	50	
Maximum Clock Jitter between two consecutive clock cycles (with allowed jitter)	tJIT(cc), allowed	MAX	140	120	100	pS
Duty cycle Jitter (with supported jitter)	tJIT(duty), allowed	MIN	min((tCH(abs),min - tCH(avg),min), (tCL(abs),min - tCL(avg),min)) * tCK(avg)			pS
		MAX	max((tCH(abs),max - tCH(avg),max), (tCL(abs),max - tCL(avg),max)) * tCK(avg)			pS
Cumulative error across 2 cycles	tERR(2per), (allowed)	MIN	-103	-88	-74	pS
		MAX	103	88	74	
Cumulative error across 3 cycles	tERR(3per), (allowed)	MIN	-122	-105	-87	pS
		MAX	122	105	87	
Cumulative error across 4 cycles	tERR(4per), (allowed)	MIN	-136	-117	-97	pS
		MAX	136	117	97	
Cumulative error across 5 cycles	tERR(5per), (allowed)	MIN	-147	-126	-105	pS
		MAX	147	126	105	
Cumulative error across 6 cycles	tERR(6per), (allowed)	MIN	-155	-133	-111	pS
		MAX	155	133	111	
Cumulative error across 7 cycles	tERR(7per), (allowed)	MIN	-163	-139	-116	pS
		MAX	163	139	116	
Cumulative error across 8 cycles	tERR(8per), (allowed)	MIN	-169	-145	-121	pS
		MAX	169	145	121	
Cumulative error across 9 cycles	tERR(9per), (allowed)	MIN	-175	-150	-125	pS
		MAX	175	150	125	
Cumulative error across 10 cycles	tERR(10per), (allowed)	MIN	-180	-154	-128	pS
		MAX	180	154	128	
Cumulative error across 11 cycles	tERR(11per), (allowed)	MIN	-184	-158	-132	pS
		MAX	184	158	132	
Cumulative error across 12 cycles	tERR(12per), (allowed)	MIN	-188	-161	-134	pS
		MAX	188	161	134	
Cumulative error across n = 13, 14 , 15..., 19, 20 cycles	tERR(nper), (allowed)	MIN	tERR(nper),allowed MIN = (1 + 0.68ln(n)) x tJIT(per),allowed MIN			pS
		MAX	tERR(nper),allowed,max = (1 + 0.68ln(n)) x tJIT(per),allowed MAX			



ZQ Calibration Parameters						
Initialization calibration time	tZQINIT	MIN	1			μS
Long calibration time	tZQCL	MIN	360			nS
Short calibration time	tZQCS	MIN	90			nS
Calibration Reset time	tZQRESET	MIN	max(50nS,3nCK)			nS
Read Parameters⁴						
DQS output access time from CK_t/CK_c	tDQSCK	MIN	2500			pS
		MAX	5500			
DQSCK delta short ⁵	tDQSCKDS	MAX	220	190	165	pS
DQSCK delta medium ⁶	tDQSCKDM	MAX	511	435	380	pS
DQSCK delta long ⁷	tDQSCKDL	MAX	614	525	460	pS
DQS-DQ skew	tDQSQ	MAX	135	115	100	pS
DQS output High pulse width	tQSH	MIN	tCH(abs) - 0.05			tCK(avg)
DQS output Low pulse width	tQSL	MIN	tCL(abs) - 0.05			tCK(avg)
DQ/DQS output hold time from DQS	tQH	MIN	min(tQSH, tQSL)			tCK(avg)
Read preamble ^{8,10}	tRPRE	MIN	0.9			tCK(avg)
Read postamble ^{8,11}	tRPST	MIN	0.3			tCK(avg)
DQS Low-Z from clock ⁸	tLZ(DQS)	MIN	tDQSCK(MIN) - 300			pS
DQ Low-Z from clock ⁸	tLZ(DQ)	MIN	tDQSCK(MIN) - 300			pS
DQS High-Z from clock ⁸	tHZ(DQS)	MAX	tDQSCK(MAX) - 100			pS
DQ High-Z from clock ⁸	tHZ(DQ)	MAX	tDQSCK(MAX) + (1.4 x tDQSQ(MAX))			pS
Write Parameters⁴						
DQ and DM input hold time (VREF based)	tDH	MIN	150	130	115	pS
DQ and DM input setup time (VREF based)	tDS	MIN	150	130	115	pS
DQ and DM input pulse width	tDIPW	MIN	0.35			tCK(avg)
Write command to 1st DQS latching transition	tDQSS	MIN	0.75			tCK(avg)
		MAX	1.25			
DQS input high-level width	tDQSH	MIN	0.4			tCK(avg)
DQS input low-level width	tDQSL	MIN	0.4			tCK(avg)
DQS falling edge to CK setup time	tDSS	MIN	0.2			tCK(avg)
DQS falling edge hold time from CK	tDSH	MIN	0.2			tCK(avg)
Write postamble	tWPST	MIN	0.4			tCK(avg)
Write preamble	tWPRE	MIN	0.8			tCK(avg)
CKE Input Parameters						
CKE minimum. pulse width (HIGH and LOW pulse width)	tCKE	MIN	max(7.5nS,3nCK)			nS
CKE input setup time	tISCKE ¹²	MIN	0.25			tCK(avg)
CKE input hold time	tIHCKE ¹³	MIN	0.25			tCK(avg)
Command path disable delay	tCPDED	MIN	2			tCK(avg)
Command Address Input Parameters⁴						
Address and control input setup time	tISCA ¹⁴	MIN	150	130	115	pS
Address and control input hold time	tIHCA ¹⁴	MIN	150	130	115	pS
CS_n input setup time	tISCS ¹⁴	MIN	270	230	205	pS
CS_n input hold time	tIHCS ¹⁴	MIN	270	230	205	pS
Address and control input pulse width	tIPWCA	MIN	0.35			tCK(avg)
CS_n input pulse width	tIPWCS	MIN	0.7			tCK(avg)
Boot Parameters (10 MHz–55 MHz)^{15, 16, 17}						
Clock Cycle Time	tCKb	MAX	100			nS
		MIN	18			
CKE Input setup time	tISCKEb	MIN	2.5			nS
CKE Input hold time	tIHCKEb	MIN	2.5			nS
Address and control input setup time	tISb	MIN	1150			pS



Address and control input hold time	tIHb	MIN	1150			pS
DQS output data access time from CK_t/CK_c	tDQSCKb	MIN	2.0			nS
		MAX	10.0			
Data strobe edge to output data edge	tDQSQb	MAX	1.2			nS
Mode Register Parameters						
Mode Register Write command period	tMRW	MIN	10			tCK(avg)
Mode Register Read command period	tMRR	MIN	4			tCK(avg)
Additional time after tXP has expired until MRR command may be issued	tMRRi	MIN	tRCD(MIN)			nS
Core Parameters^{*18}						
Read Latency	RL	MIN	12	14	16	tCK(avg)
Write Latency (set A)	WL	MIN	6	8	8	tCK(avg)
Activate to Activate command period	tRC	MIN	tRAS + tRPab (with all-bank precharge) tRAS + tRPpb (with per-bank precharge)			nS
CKE minimum pulse width during Self Refresh (low pulse width during Self Refresh)	tCKESR	MIN	max(15nS,3nCK)			nS
Self Refresh exit to next valid command delay	tXSR	MIN	max(tRFCab + 10nS, 2nCK)			nS
Exit power-down to next valid command delay	tXP	MIN	max(7.5nS, 3nCK)			nS
CAS-to-CAS delay	tCCD	MIN	4			tCK(avg)
Internal Read to Precharge command delay	tRTP	MIN	max(7.5nS, 4nCK)			nS
RAS to CAS Delay	tRCD (typ)	MIN	max(18nS, 3nCK)			nS
Row precharge time (single bank)	tRPpb (typ)	MIN	max(18nS, 3nCK)			nS
Row precharge time (all banks)	tRPab (typ)	MIN	max(21nS, 3nCK)			nS
Row active time	tRAS	MIN	max(42nS, 3nCK)			nS
		MAX	min(70.2, 9 x RM x tREFI)			μS
Write Recovery Time	tWR	MIN	max(15nS, 4nCK)			nS
Internal Write-to-Read command delay	tWTR	MIN	max(7.5nS, 4nCK)			nS
Active bank A to active bank B	tRRD	MIN	max(10nS, 2nCK)			nS
Four-bank Activate Window	tFAW	MIN	max(50nS, 8nCK)			nS
Minimum deep power-down time	tDPD	MIN	500			μS
ODT Parameters						
Asynchronous RTT turn-on delay from ODT input	tODTon	MIN	1.75			nS
		MAX	3.5			
Asynchronous RTT turn-off delay from ODT input	tODToff	MIN	1.75			nS
		MAX	3.5			
Automatic RTT turn-on delay after Read data	tAODTon	MAX	tDQSCK + 1.4 x tDQSQ,max + tCK(avg,min)			pS
Automatic RTT turn-off delay after Read data	tAODToff	MIN	tDQSCK,min - 300			pS
RTT disable delay from power down entry	tODTd	MAX	12			nS
RTT disable delay from self-refresh, and deep power down entry	tODTd	MAX	12 + 0.5 tCK			nS
RTT enable delay from power down and self refresh exit	tODTe	MAX	12			nS
CA Training Parameters						
First CA calibration command after CA calibration mode is programmed	tCAMRD	MIN	20			tCK(avg)
First CA calibration command after CKE is LOW	tCAENT	MIN	10			tCK(avg)
CA calibration exit command after CKE is HIGH	tCAEXT	MIN	10			tCK(avg)
CKE LOW after CA calibration mode is programmed	tCACKEL	MIN	10			tCK(avg)
CKE HIGH after the last CA calibration results are driven	tCACKEH	MIN	10			tCK(avg)
Data out delay after CA training calibration command is programmed	tADR	MAX	20			nS
MRW CA exit command to DQ tri-state	tMRZ	MIN	3			nS
CA calibration command to CA calibration command delay	tCACD	MIN	RU(tADR+2 x tCK)			tCK(avg)



Write Leveling Parameters						
DQS_t/DQS_c delay after write leveling mode is programmed	tWLDQSEN	MIN	25			nS
		MAX	-			
First DQS_t/DQS_c edge after write leveling mode is programmed	tWLMRD	MIN	40			nS
		MAX	-			
Write leveling output delay	twLO	MIN	0			nS
		MAX	20			
Write leveling hold time	tWLH	MIN	175	150	135	pS
Write leveling setup time	tWLS	MIN	175	150	135	pS
Mode register set command delay	tMRD	MIN	max(14nS, 10nCK)			nS
		MAX	-			
Temperature Derating ^{*17}						
DQS output access time from CK_t/CK_c (derated)	tDQSC	MAX	5620			pS
RAS-to-CAS delay (derated)	tRCD	MIN	tRCD + 1.875			nS
Activate -to- Activate command period (derated)	tRC	MIN	tRC + 1.875			nS
Row active time (derated)	tRAS	MIN	tRAS + 1.875			nS
Row precharge time (derated)	tRP	MIN	tRP + 1.875			nS
Active bank A to active bank B (derated)	tRRD	MIN	tRRD + 1.875			nS

Notes:

1. Frequency values are for reference only. Clock cycle time (tCK) is used to determine device capabilities.
2. All AC timings assume an input slew rate of 2 V/nS for single ended signals.
3. Measured with 4 V/nS differential CK_t/CK_c slew rate and nominal Vix.
4. Read, Write, and input setup and hold values are referenced to VREF.
5. tDQSCKDS is the absolute value of the difference between any two tDQSCK measurements (in a byte lane) within a contiguous sequence of bursts in a 160nS rolling window. tDQSCKDS is not tested and is guaranteed by design. Temperature drift in the system is < 10 °C/S. Values do not include clock jitter.
6. tDQSCKDM is the absolute value of the difference between any two tDQSCK measurements (in a byte lane) within a 1.6µS rolling window. tDQSCKDM is not tested and is guaranteed by design. Temperature drift in the system is < 10 °C/S. Values do not include clock jitter.
7. tDQSCKDL is the absolute value of the difference between any two tDQSCK measurements (in a byte lane) within a 32mS rolling window. tDQSCKDL is not tested and is guaranteed by design. Temperature drift in the system is < 10 °C/S. Values do not include clock jitter.
8. For LOW-to-HIGH and HIGH-to-LOW transitions, the timing reference is at the point when the signal crosses the transition threshold (VTT). tHZ and tLZ transitions occur in the same access time (with respect to clock) as valid data transitions. These parameters are not referenced to a specific voltage level but to the time when the device output is no longer driving (for tRPST, tHZ(DQS) and tHZ(DQ)), or begins driving (for tRPRE, tLZ(DQS), tLZ(DQ)). The figure below shows a method to calculate the point when device is no longer driving tHZ(DQS) and tHZ(DQ), or begins driving tLZ(DQS) and tLZ(DQ) by measuring the signal at two different voltages. The actual voltage measurement points are not critical as long as the calculation is consistent.

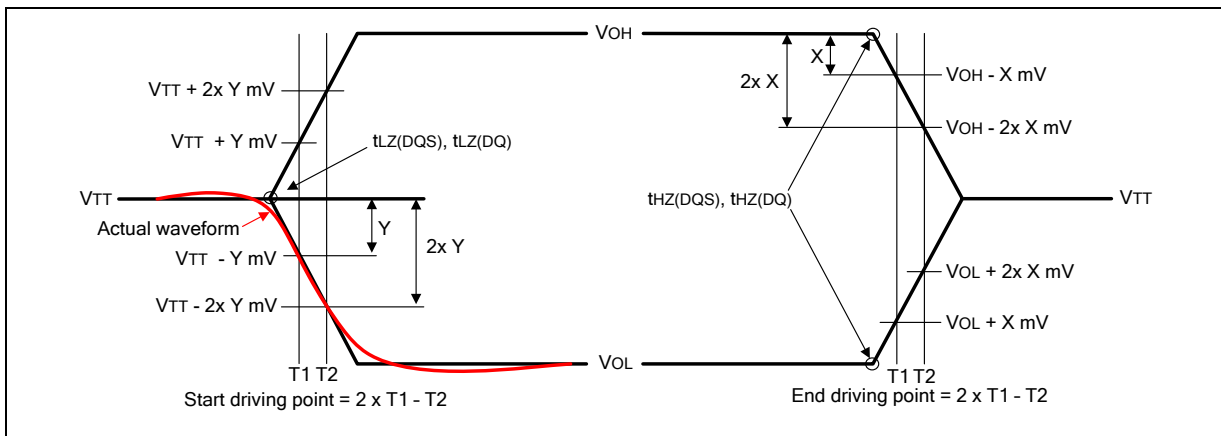

Output Transition Timing

9. The parameters tLZ(DQS), tLZ(DQ), tHZ(DQS), and tHZ(DQ) are defined as single-ended. The timing parameters tRPRE and tRPST are determined from the differential signal DQS_t/DQS_c.



10. Measured from the point when DQS_t/DQS_c begins driving the signal to the point when DQS_t/DQS_c begins driving the first rising strobe edge.
11. Measured from the last falling strobe edge of DQS_t/DQS_c to the point when DQS_t/DQS_c finishes driving the signal.
12. CKE input setup time is measured from CKE reaching a HIGH/LOW voltage level to CK_t/CK_c crossing.
13. CKE input hold time is measured from CK_t/CK_c crossing to CKE reaching a HIGH/LOW voltage level.
14. Input set-up/hold time for signal (CA[9:0], CS_n).
15. To ensure device operation before the device is configured, a number of AC boot-timing parameters are defined in this table. Boot parameter symbols have the letter b appended (for example, tCK during boot is tCKb).
16. The LPDDR3 device will set some mode register default values upon receiving a RESET (MRW) command as specified in "Mode Register Definition".
17. The output skew parameters are measured with default output impedance settings using the reference load.
18. The minimum tCK column applies only when tCK is greater than 6nS.
19. All parts list in section 3 order information table will not guarantee to meet functional and AC specification if the tCK(avg) out of range mentioned in above table.



8.8.2 CA and CS_n Setup, Hold and Derating

For all input signals (CA and CS_n) the total t_{IS} (setup time) and t_{IH} (hold time) required is calculated by adding the datasheet $t_{IS}(\text{base})$ and $t_{IH}(\text{base})$ value (see the CA and CS-n Setup and Hold Base-Values tables) to the Δt_{IS} and Δt_{IH} derating value (see the Derating values t_{IS}/t_{IH} - ac/dc based AC150 and AC135 tables) respectively. Example: t_{IS} (total setup time) = $t_{IS}(\text{base}) + \Delta t_{IS}$.

Setup (t_{IS}) nominal slew rate for a rising signal is defined as the slew rate between the last crossing of $V_{REF(dc)}$ and the first crossing of $V_{IH(ac)min}$. Setup (t_{IS}) nominal slew rate for a falling signal is defined as the slew rate between the last crossing of $V_{REF(dc)}$ and the first crossing of $V_{IL(ac)max}$. If the actual signal is always earlier than the nominal slew rate line between shaded ' $V_{REF(dc)}$ to ac region', use nominal slew rate for derating value (see Figure 77). If the actual signal is later than the nominal slew rate line anywhere between shaded ' $V_{REF(dc)}$ to ac region', the slew rate of a tangent line to the actual signal from the ac level to dc level is used for derating value (see Figure 79).

Hold (t_{IH}) nominal slew rate for a rising signal is defined as the slew rate between the last crossing of $V_{IL(dc)max}$ and the first crossing of $V_{REF(dc)}$. Hold (t_{IH}) nominal slew rate for a falling signal is defined as the slew rate between the last crossing of $V_{IH(dc)min}$ and the first crossing of $V_{REF(dc)}$. If the actual signal is always later than the nominal slew rate line between shaded ' dc to $V_{REF(dc)}$ region', use nominal slew rate for derating value (see Figure 78). If the actual signal is earlier than the nominal slew rate line anywhere between shaded ' dc to $V_{REF(dc)}$ region', the slew rate of a tangent line to the actual signal from the dc level to $V_{REF(dc)}$ level is used for derating value (see Figure 80).

For a valid transition the input signal has to remain above/below $V_{IH/IL(ac)}$ for some time t_{VAC} (see the Required time t_{VAC} above $V_{IH(ac)}$ {below $V_{IL(ac)}$ } for valid transition for CA table).

Although for slow slew rates the total setup time might be negative (i.e. a valid input signal will not have reached $V_{IH/IL(ac)}$ at the time of the rising clock transition) a valid input signal is still required to complete the transition and reach $V_{IH/IL(ac)}$.

For slew rates in between the values listed in the Derating values t_{IS}/t_{IH} - ac/dc based AC150 and AC135 tables, the derating values may obtained by linear interpolation. These values are typically not subject to production test. They are verified by design and characterization.

Table of CA Setup and Hold Base-Values

Unit [pS]	Data Rate			reference
	1600	1866	2133	
$t_{ISCA}(\text{base})$	75	-	-	$V_{IH/IL(ac)} = V_{REF(dc)} \pm 150mV$
$t_{ISCA}(\text{base})$	-	62.5	47.5	$V_{IH/IL(ac)} = V_{REF(dc)} \pm 135mV$
$t_{IHCA}(\text{base})$	100	80	65	$V_{IH/IL(dc)} = V_{REF(dc)} \pm 100mV$

Note: AC/DC referenced for 2V/nS CA slew rate and 4V/nS differential CK_t-CK_c slew rate.

Table of CS_n Setup and Hold Base-Values

Unit [pS]	Data Rate			reference
	1600	1866	2133	
$t_{ISCS}(\text{base})$	195	-	-	$V_{IH/IL(ac)} = V_{REF(dc)} \pm 150mV$
$t_{ISCS}(\text{base})$	-	162.5	137.5	$V_{IH/IL(ac)} = V_{REF(dc)} \pm 135mV$
$t_{IHCS}(\text{base})$	220	180	155	$V_{IH/IL(dc)} = V_{REF(dc)} \pm 100mV$

Note: AC/DC referenced for 2V/nS CS_n slew rate and 4V/nS differential CK_t-CK_c slew rate.



Table of Derating values t_{IS}/t_{IH} - ac/dc based AC150

Δt_{ISCA} , Δt_{IHCA} , Δt_{ISCS} , Δt_{IHCS} derating in [pS] AC/DC based AC150 Threshold $\geq V_{IH(ac)} = V_{REF(dc)} + 150mV$, $V_{IL(ac)} = V_{REF(dc)} - 150mV$ DC100 Threshold $\geq V_{IH(dc)} = V_{REF(dc)} + 100mV$, $V_{IL(dc)} = V_{REF(dc)} - 100mV$												
CA, CS_n Slew Rate V/nS	CK_t, CK_c Differential Slew Rate											
	8.0 V/nS		7.0 V/nS		6.0 V/nS		5.0 V/nS		4.0 V/nS		3.0 V/nS	
	Δt_{IS}	Δt_{IH}	Δt_{IS}	Δt_{IH}	Δt_{IS}	Δt_{IH}	Δt_{IS}	Δt_{IH}	Δt_{IS}	Δt_{IH}	Δt_{IS}	Δt_{IH}
4.0	38	25	38	25	38	25	38	25	38	25	-	-
3.0	-	-	25	17	25	17	25	17	25	17	38	29
2.0	-	-	-	-	0	0	0	0	0	0	13	13
1.5	-	-	-	-	-	-	-25	-17	-25	-17	-12	-4

Note: Cell contents '-' are defined as not supported.

Table of Derating Values t_{IS}/t_{IH} - ac/dc Based AC135

Δt_{ISCA} , Δt_{IHCA} , Δt_{ISCS} , Δt_{IHCS} derating in [pS] AC/DC based AC135 Threshold $\geq V_{IH(ac)} = V_{REF(dc)} + 135mV$, $V_{IL(ac)} = V_{REF(dc)} - 135mV$ DC100 Threshold $\geq V_{IH(dc)} = V_{REF(dc)} + 100mV$, $V_{IL(dc)} = V_{REF(dc)} - 100mV$												
CA, CS_n Slew Rate V/nS	CK_t, CK_c Differential Slew Rate											
	8.0 V/nS		7.0 V/nS		6.0 V/nS		5.0 V/nS		4.0 V/nS		3.0 V/nS	
	Δt_{IS}	Δt_{IH}	Δt_{IS}	Δt_{IH}	Δt_{IS}	Δt_{IH}	Δt_{IS}	Δt_{IH}	Δt_{IS}	Δt_{IH}	Δt_{IS}	Δt_{IH}
4.0	34	25	34	25	34	25	34	25	34	25	-	-
3.0	-	-	23	17	23	17	23	17	23	17	34	29
2.0	-	-	-	-	0	0	0	0	0	0	11	13
1.5	-	-	-	-	-	-	-23	-17	-23	-17	-12	-4

Note: Cell contents '-' are defined as not supported.

Table of Required time t_{VAC} above $V_{IH(ac)}$ (below $V_{IL(ac)}$) for valid transition for CA

Slew Rate [V/nS]	t_{VAC} [pS] @ 150mV 1600Mbps		t_{VAC} [pS] @ 135mV 1866Mbps		t_{VAC} [pS] @ 135mV 2133Mbps	
	min	max	min	max	min	max
> 4.0	48	-	40	-	34	-
4.0	48	-	40	-	34	-
3.5	46	-	39	-	33	-
3.0	43	-	36	-	30	-
2.5	40	-	33	-	27	-
2.0	35	-	29	-	23	-
1.5	27	-	21	-	15	-
<1.5	27	-	21	-	15	-

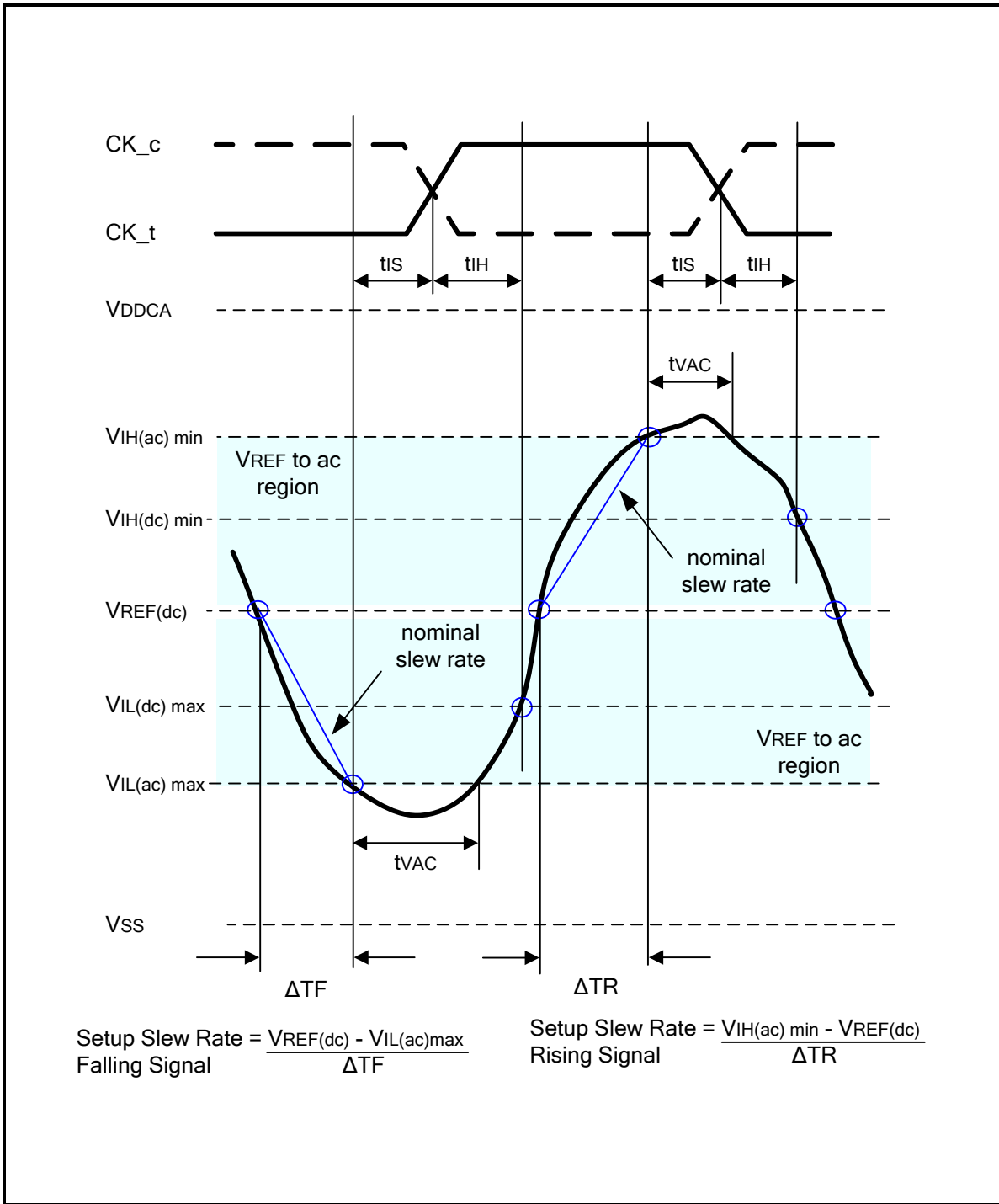

Figure 77 - Nominal slew rate and t_{VAC} for setup time t_{IS} for CA and CS_n with respect to clock

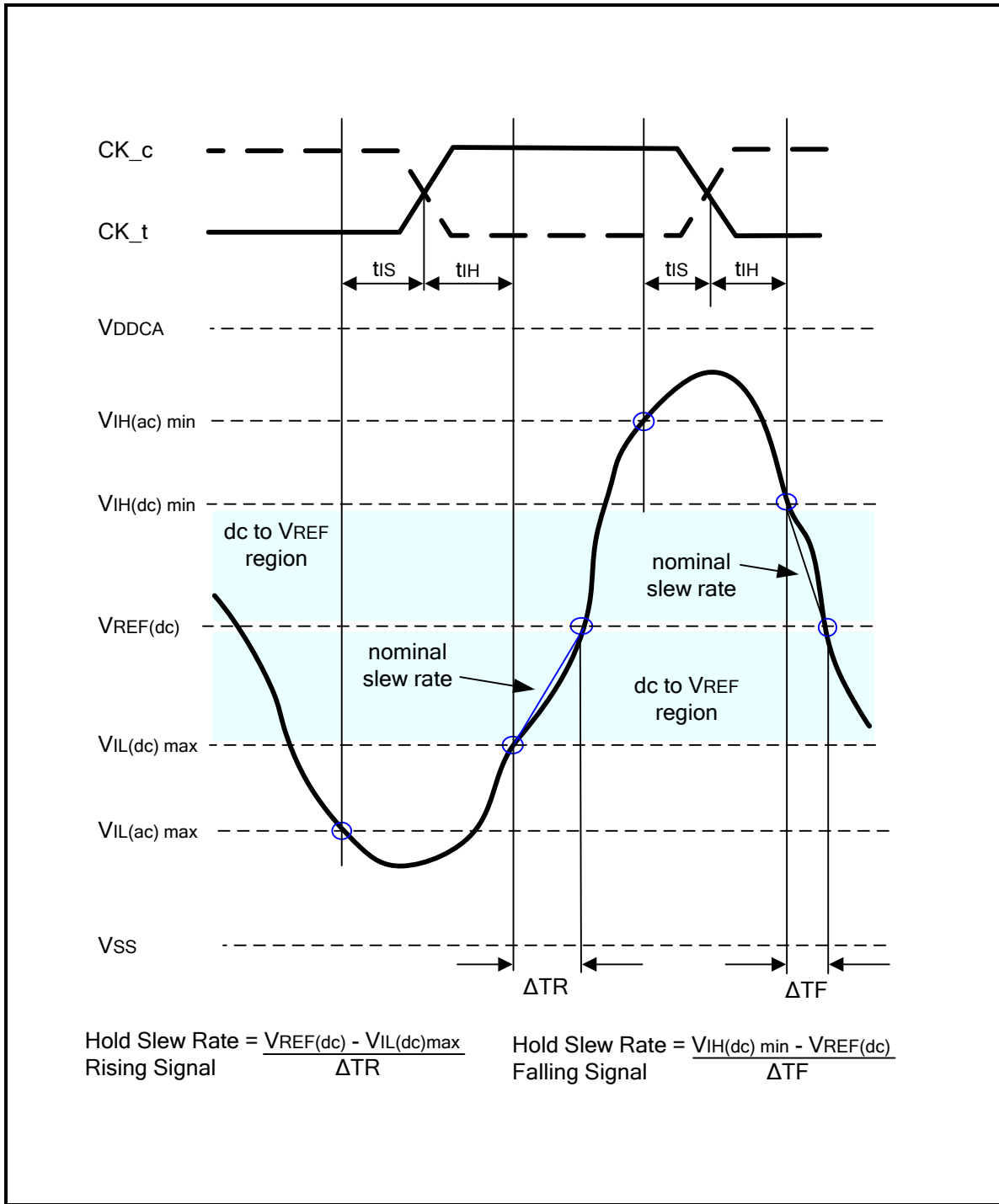

Figure 78 - Nominal slew rate for hold time t_{IH} for CA and CS_n with respect to clock

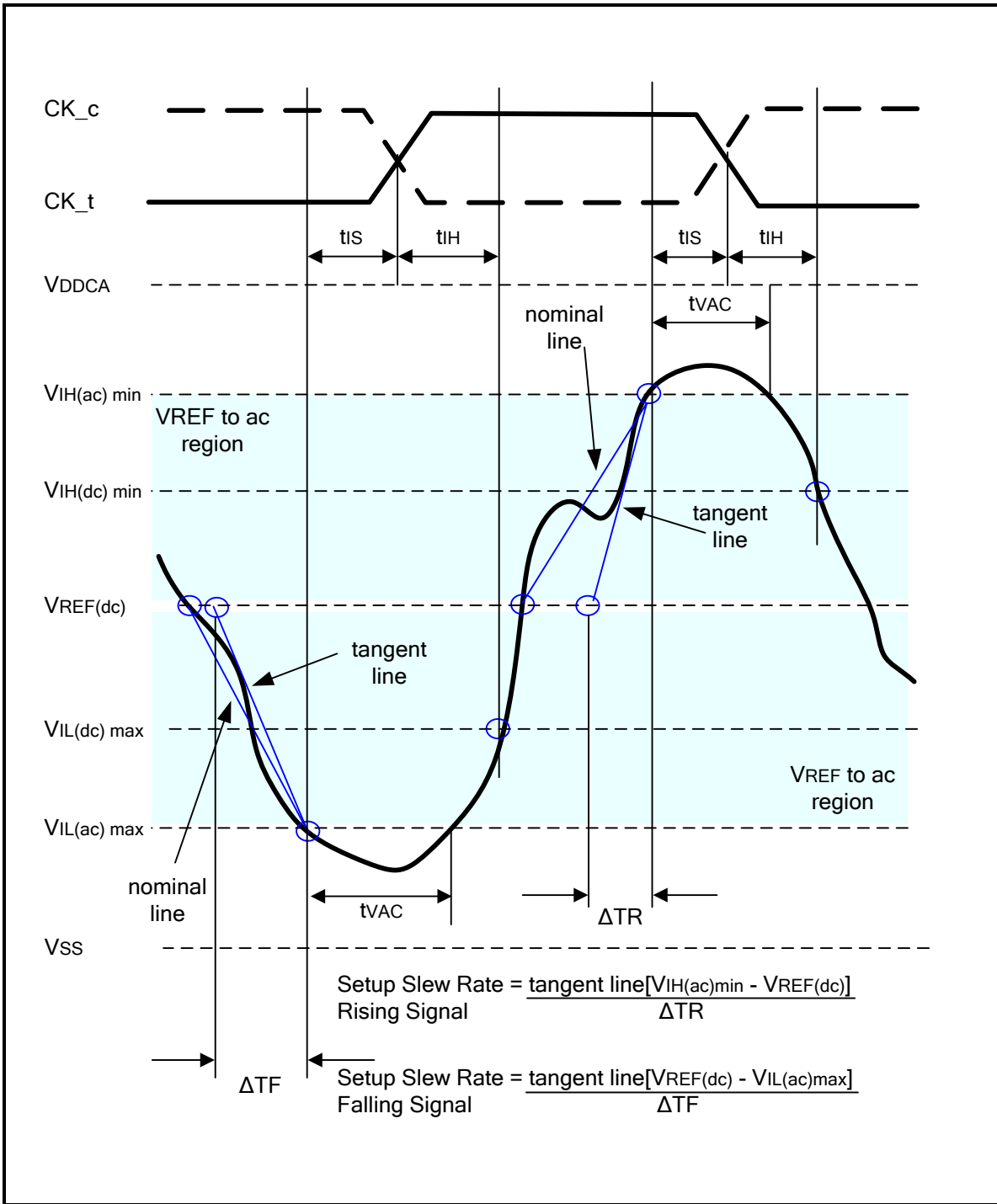

Figure 79 - Tangent line for setup time t_{IS} for CA and CS_n with respect to clock

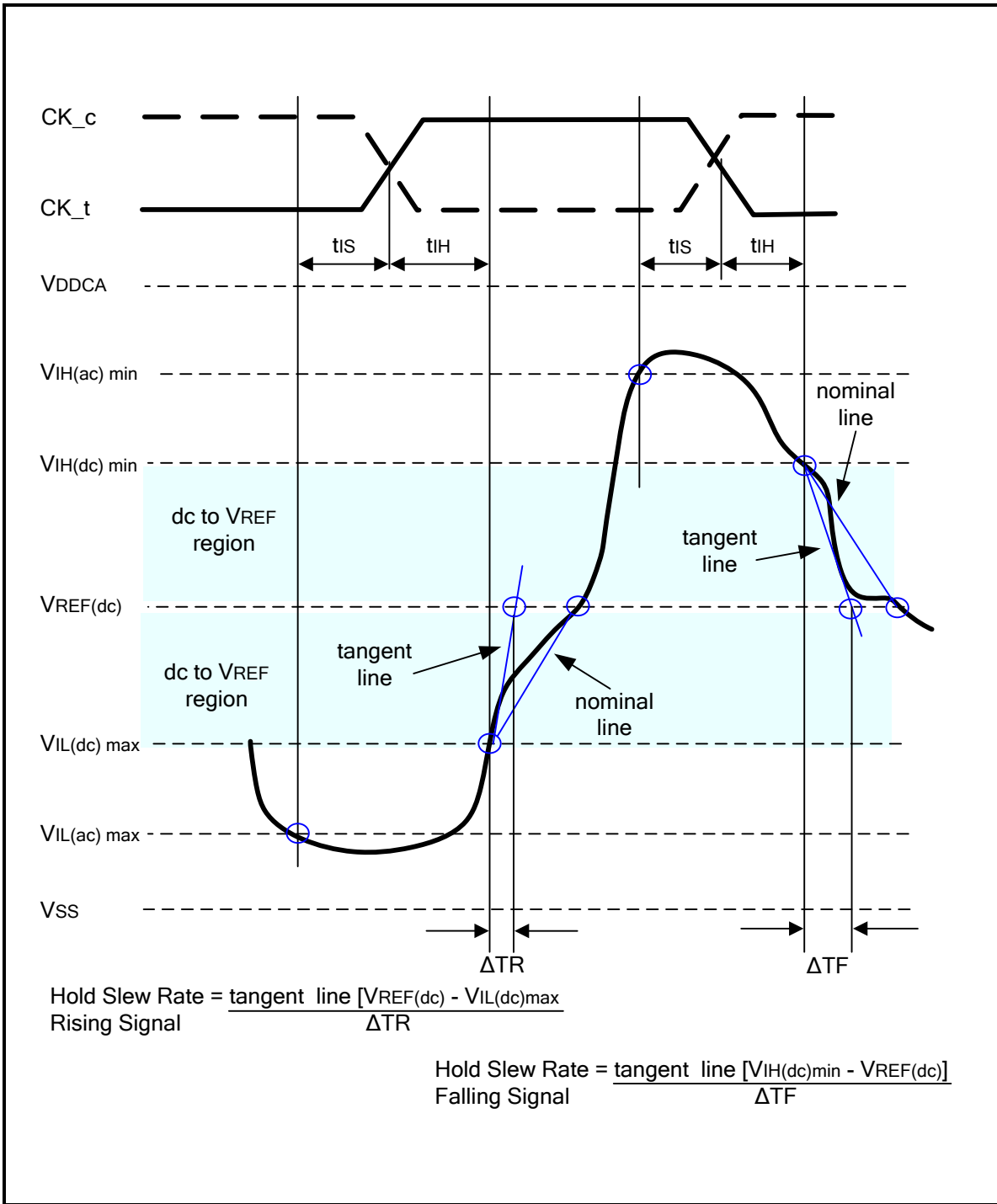

Figure 80 - Tangent line for hold time t_{IH} for CA and CS_n with respect to clock



8.8.3 Data Setup, Hold and Slew Rate Derating

For all input signals (DQ, DM) the total t_{DS} (setup time) and t_{DH} (hold time) required is calculated by adding the data sheet $t_{DS}(\text{base})$ and $t_{DH}(\text{base})$ value (see the Data Setup and Hold Base-Values table) to the Δt_{DS} and Δt_{DH} derating value (see the Derating values LPDDR3 t_{DS}/t_{DH} - ac/dc based AC150 and AC135 tables) respectively. Example: t_{DS} (total setup time) = $t_{DS}(\text{base}) + \Delta t_{DS}$.

Setup (t_{DS}) nominal slew rate for a rising signal is defined as the slew rate between the last crossing of $V_{REF(dc)}$ and the first crossing of $V_{IH(ac)min}$. Setup (t_{DS}) nominal slew rate for a falling signal is defined as the slew rate between the last crossing of $V_{REF(dc)}$ and the first crossing of $V_{IL(ac)max}$ (see Figure 81). If the actual signal is always earlier than the nominal slew rate line between shaded ' $V_{REF(dc)}$ to ac region', use nominal slew rate for derating value. If the actual signal is later than the nominal slew rate line anywhere between shaded ' $V_{REF(dc)}$ to ac region', the slew rate of a tangent line to the actual signal from the ac level to dc level is used for derating value (see Figure 83).

Hold (t_{DH}) nominal slew rate for a rising signal is defined as the slew rate between the last crossing of $V_{IL(dc)max}$ and the first crossing of $V_{REF(dc)}$. Hold (t_{DH}) nominal slew rate for a falling signal is defined as the slew rate between the last crossing of $V_{IH(dc)min}$ and the first crossing of $V_{REF(dc)}$ (see Figure 82). If the actual signal is always later than the nominal slew rate line between shaded 'dc level to $V_{REF(dc)}$ region', use nominal slew rate for derating value. If the actual signal is earlier than the nominal slew rate line anywhere between shaded 'dc to $V_{REF(dc)}$ region', the slew rate of a tangent line to the actual signal from the dc level to $V_{REF(dc)}$ level is used for derating value (see Figure 84).

For a valid transition the input signal has to remain above/below $V_{IH/IL(ac)}$ for some time t_{VAC} (see Required time t_{VAC} above $V_{IH(ac)}$ {below $V_{IL(ac)}$ } for valid transition for DQ, DM Table).

Although for slow slew rates the total setup time might be negative (i.e. a valid input signal will not have reached $V_{IH/IL(ac)}$ at the time of the rising clock transition) a valid input signal is still required to complete the transition and reach $V_{IH/IL(ac)}$.

For slew rates in between the values listed in the Derating values LPDDR3 t_{DS}/t_{DH} - ac/dc based AC150 and AC135 tables, the derating values may obtained by linear interpolation. These values are typically not subject to production test. They are verified by design and characterization.

Table of Data Setup and Hold Base-Values

Unit [pS]	Data Rate			reference
	1600	1866	2133	
$t_{DS}(\text{base})$	75	-	-	$V_{IH/IL(ac)} = V_{REF(dc)} \pm 150\text{mV}$
$t_{DS}(\text{base})$	-	62.5	47.5	$V_{IH/IL(ac)} = V_{REF(dc)} \pm 135\text{mV}$
$t_{DH}(\text{base})$	100	80	65	$V_{IH/IL(dc)} = V_{REF(dc)} \pm 100\text{mV}$

Note: AC/DC referenced for 2V/nS DQ, DM slew rate and 4V/nS differential DQS_t-DQS_c slew rate and nominal V_IX.



Table of Derating values LPDDR3 t_{DS}/t_{DH} - ac/dc based AC150

$\Delta t_{DS}, \Delta t_{DH}$ derating in [pS] AC/DC based AC150 Threshold $\geq V_{IH(ac)} = V_{REF(dc)} + 150mV, V_{IL(ac)} = V_{REF(dc)} - 150mV$ DC100 Threshold $\geq V_{IH(dc)} = V_{REF(dc)} + 100mV, V_{IL(dc)} = V_{REF(dc)} - 100mV$												
DQ, DM Slew Rate V/nS	DQS_t, DQS_c Differential Slew Rate											
	8.0 V/nS		7.0 V/nS		6.0 V/nS		5.0 V/nS		4.0 V/nS		3.0 V/nS	
	Δt_{DS}	Δt_{DH}	Δt_{DS}	Δt_{DH}	Δt_{DS}	Δt_{DH}	Δt_{DS}	Δt_{DH}	Δt_{DS}	Δt_{DH}	Δt_{DS}	Δt_{DH}
4.0	38	25	38	25	38	25	38	25	38	25	-	-
3.0	-	-	25	17	25	17	25	17	25	17	38	29
2.0	-	-	-	-	0	0	0	0	0	0	13	13
1.5	-	-	-	-	-	-	-25	-17	-25	-17	-12	-4

Note: Cell contents '-' are defined as not supported.

Table of Derating values LPDDR3 t_{DS}/t_{DH} - ac/dc based AC135

$\Delta t_{DS}, \Delta t_{DH}$ derating in [pS] AC/DC based AC135 Threshold $\rightarrow V_{IH(ac)} = V_{REF(dc)} + 135mV, V_{IL(ac)} = V_{REF(dc)} - 135mV$ DC100 Threshold $\rightarrow V_{IH(dc)} = V_{REF(dc)} + 100mV, V_{IL(dc)} = V_{REF(dc)} - 100mV$												
DQ, DM Slew Rate V/nS	DQS_t, DQS_c Differential Slew Rate											
	8.0 V/nS		7.0 V/nS		6.0 V/nS		5.0 V/nS		4.0 V/nS		3.0 V/nS	
	Δt_{DS}	Δt_{DH}	Δt_{DS}	Δt_{DH}	Δt_{DS}	Δt_{DH}	Δt_{DS}	Δt_{DH}	Δt_{DS}	Δt_{DH}	Δt_{DS}	Δt_{DH}
4.0	34	25	34	25	34	25	34	25	34	25	-	-
3.0	-	-	23	17	23	17	23	17	23	17	34	29
2.0	-	-	-	-	0	0	0	0	0	0	11	13
1.5	-	-	-	-	-	-	-23	-17	-23	-17	-12	-4

Note: Cell contents '-' are defined as not supported.

Table of Required time t_{VAC} above V_{IH(ac)} {below V_{IL(ac)}} for valid transition for DQ, DM

Slew Rate [V/nS]	t _{VAC} [pS] @ 150mV 1600Mbps		t _{VAC} [pS] @ 135mV 1866Mbps		t _{VAC} [pS] @ 135mV 2133Mbps	
	min	max	min	max	min	max
> 4.0	48	-	40	-	34	-
4.0	48	-	40	-	34	-
3.5	46	-	39	-	33	-
3.0	43	-	36	-	30	-
2.5	40	-	33	-	27	-
2.0	35	-	29	-	23	-
1.5	27	-	21	-	15	-
<1.5	27	-	21	-	15	-

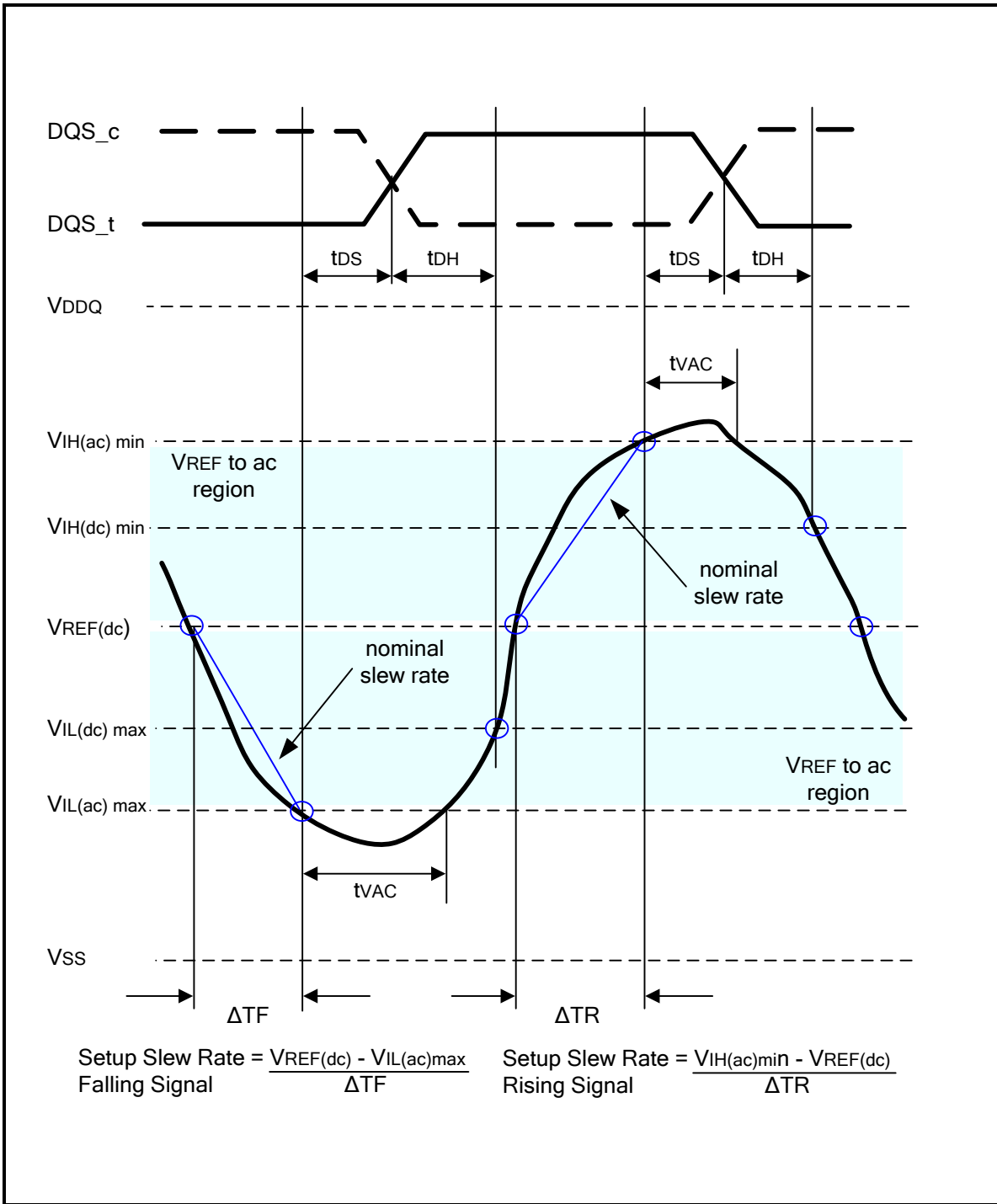

Figure 81 - Nominal slew rate and tvAC for setup time tDS for DQ with respect to strobe

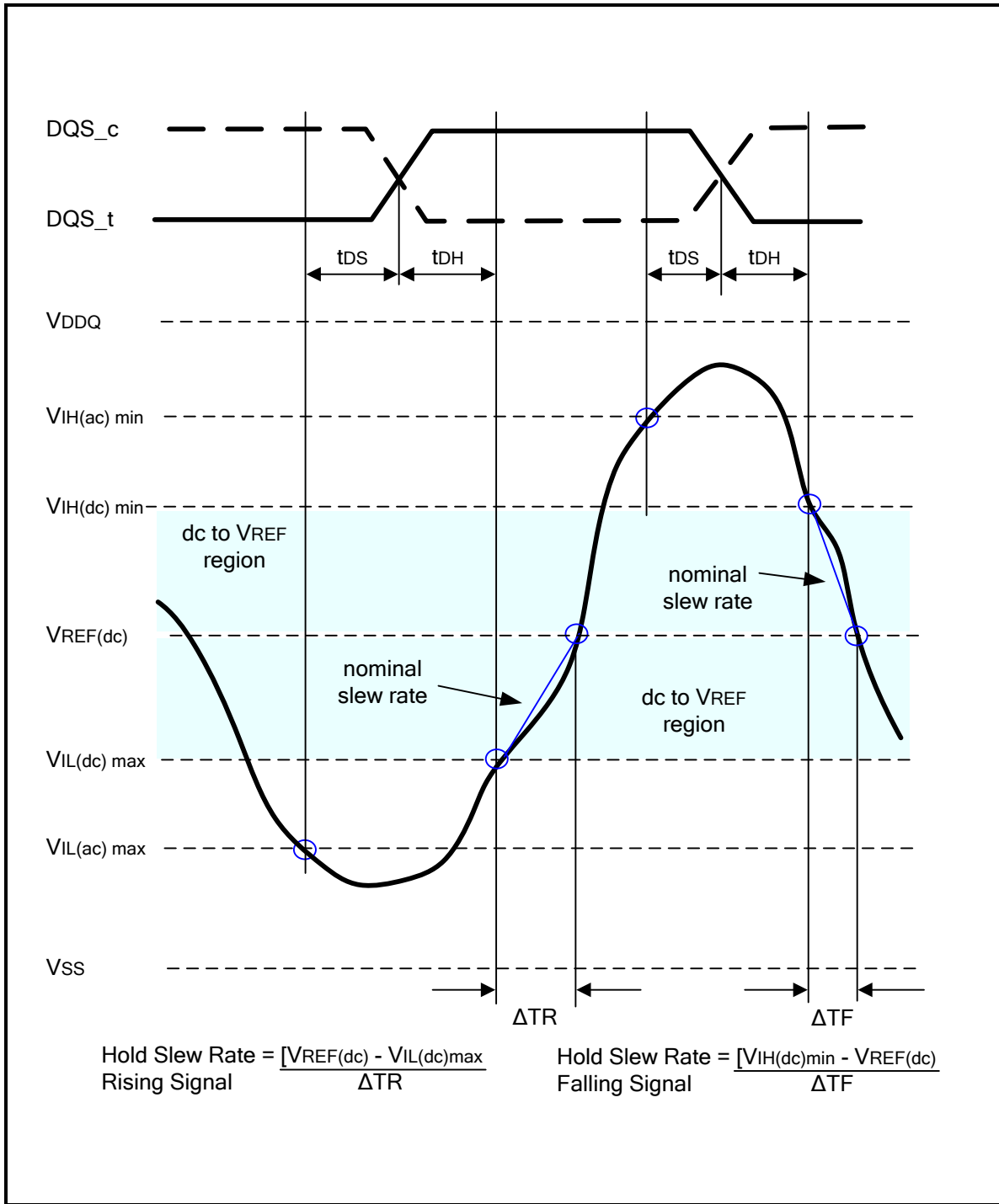

Figure 82 - Nominal slew rate for hold time t_{DH} for DQ with respect to strobe

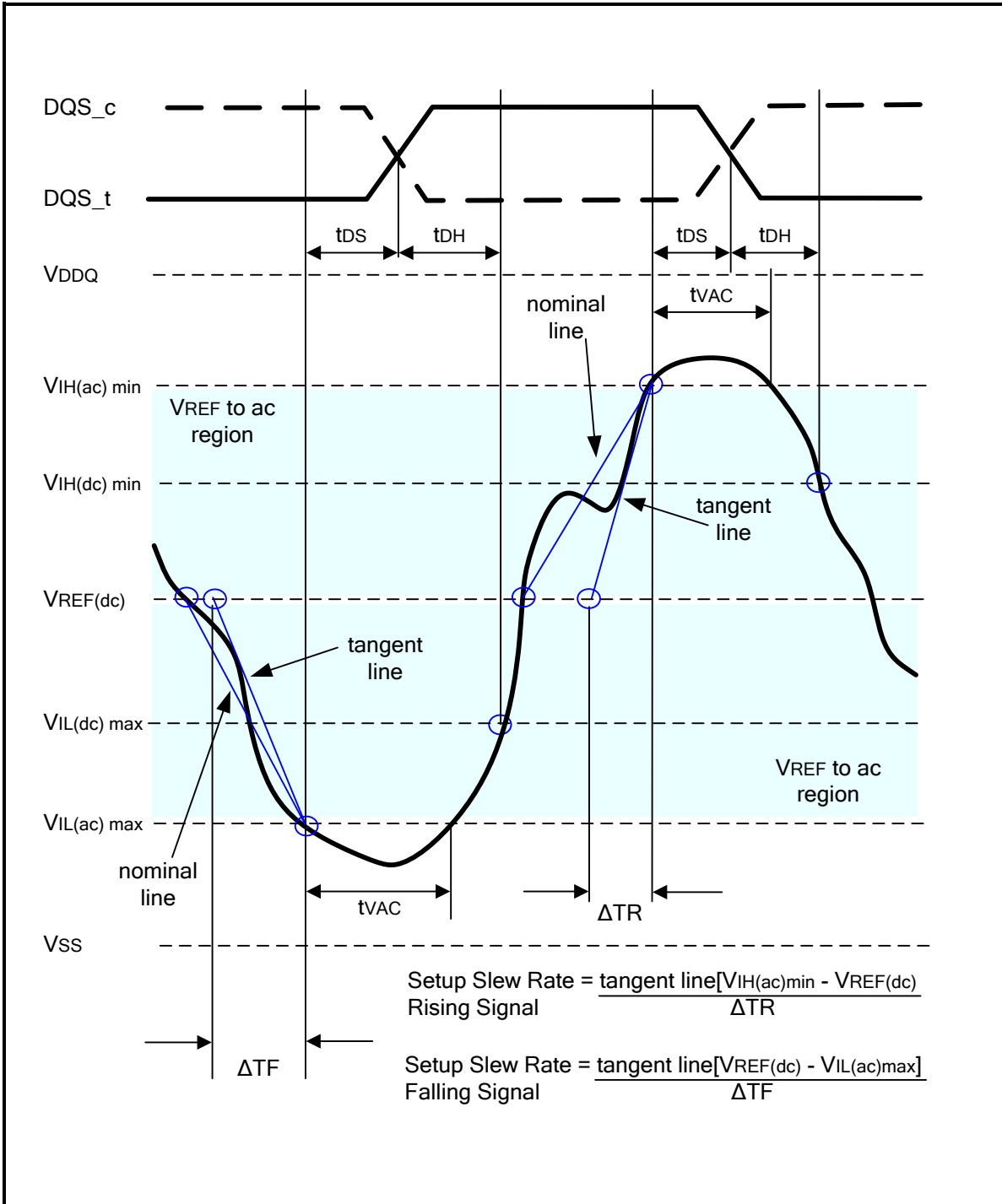

Figure 83 - Tangent line for setup time t_{DS} for DQ with respect to strobe

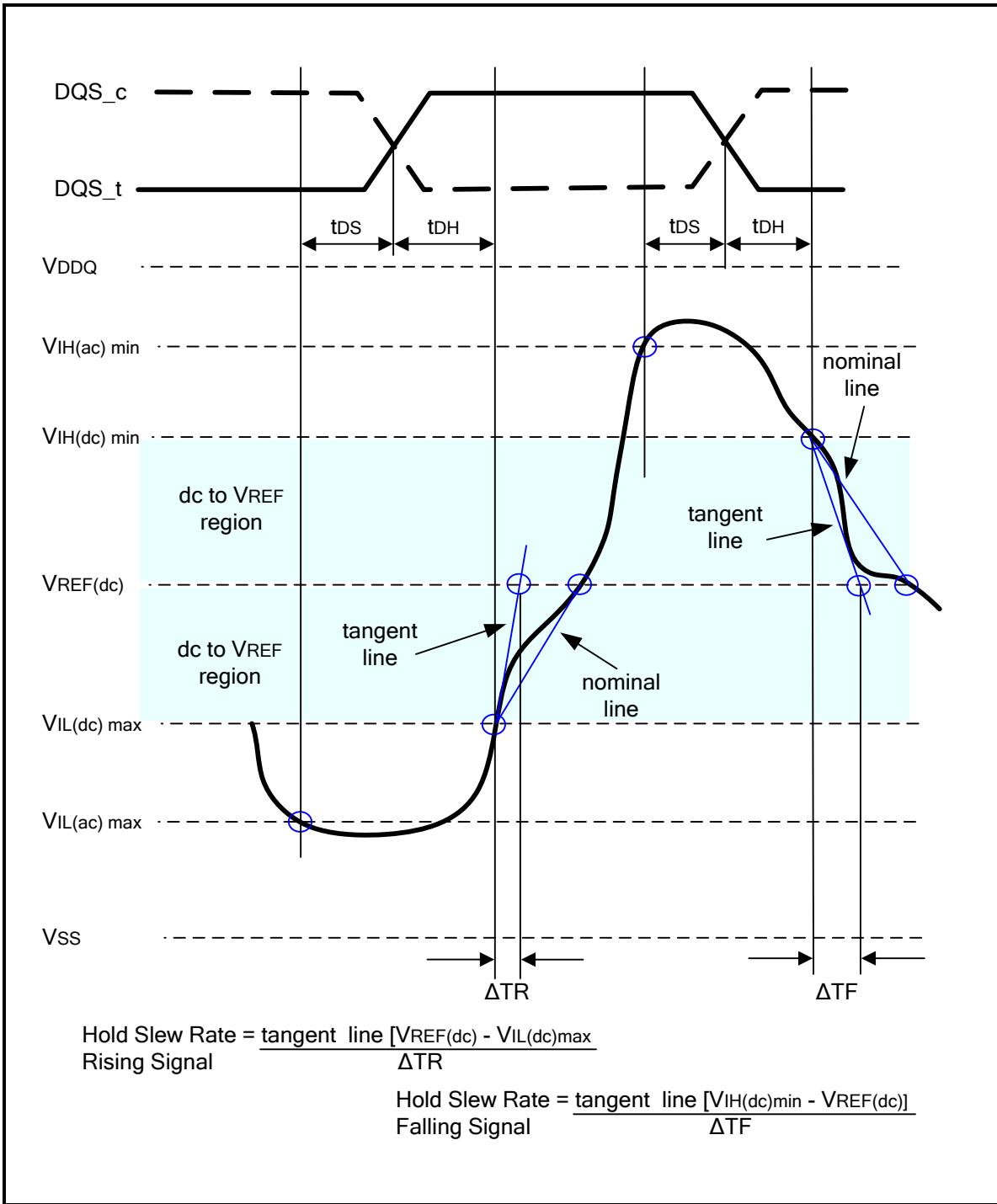
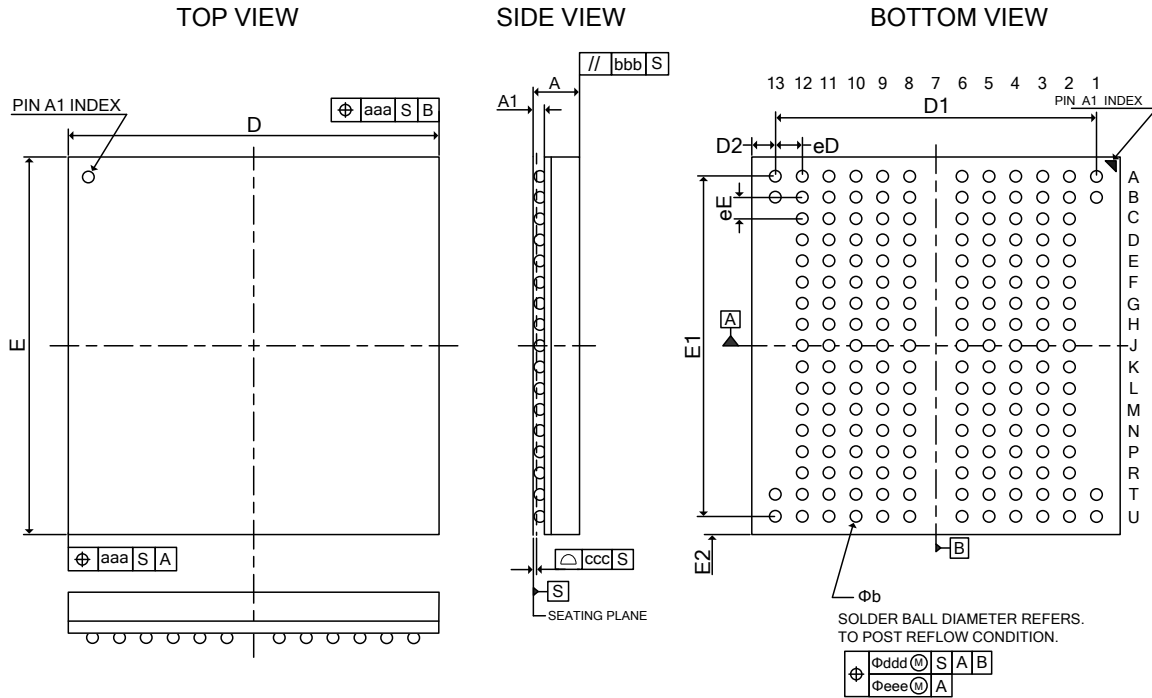

Figure 84 - Tangent line for hold time t_{DH} for DQ with respect to strobe



9. PACKAGE DIMENSIONS

Package Outline VFBGA 178 Ball (11x11.5 mm²) Solder ball size: 0.3mm



Controlling Dimension: Millimeters

SYMBOL	DIMENSION (MM)			DIMENSION (Inch)		
	MIN.	NOM.	MAX.	MIN.	NOM.	MAX.
A	0.80	0.90	1.00	0.031	0.035	0.039
A1	0.18	0.23	0.28	0.007	0.009	0.011
b	0.26	0.31	0.36	0.010	0.012	0.014
D	10.90	11.00	11.10	0.429	0.433	0.437
E	11.40	11.50	11.60	0.449	0.453	0.457
D1	9.60 BSC.			0.378 BSC.		
E1	10.40 BSC.			0.409 BSC.		
D2	0.70 BSC.			0.028 BSC.		
E2	0.55 BSC.			0.022 BSC.		
eD	0.80 BSC.			0.032 BSC.		
eE	0.65 BSC.			0.026 BSC.		
aaa	---	---	0.15	---	---	0.006
bbb	---	---	0.10	---	---	0.004
ccc	---	---	0.10	---	---	0.004
ddd	---	---	0.15	---	---	0.006
eee	---	---	0.05	---	---	0.002

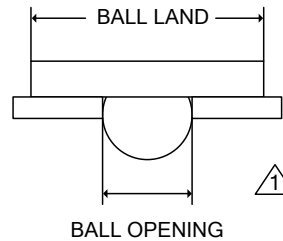

Note:
1. Ball land: 0.38mm, Ball opening: 0.28mm,
PCB Ball land suggested ≤ 0.38mm



10. REVISION HISTORY

VERSION	DATE	PAGE	DESCRIPTION
A01-001	May 30, 2019	All	Initial formal datasheet
A01-002	Jul. 24, 2019	97	Revise 800 & 1066 MHz IDD5AB1 spec value (1mA ---> 1.22mA)
			Revise 800 MHz IDD5AB2 spec value (11mA ---> 10.5mA)
A01-003	Dec. 03, 2019	5, 74, 75, 79, 85, 95~97, 104~107, 109, 110, 115, 116	Add four of 933 MHz x16 and 32 VFBGA178 package part numbers and DC/AC spec

*Please note that all data and specifications are subject to change without notice.
All the trademarks of products and companies mentioned in this datasheet belong to their respective owners.*

*Publication Release Date: Dec. 03, 2019
Revision: A01-003*