



W6/W9 series

Magnetic Hydraulic Circuit Breakers



Features

- Designed for the international market. UL Recognized, CSA Certified, and VDE approved.
- Ratings to 50 amps.
- Heavy duty #10-32 stud connections. (W9)
- Optional 10 amp auxiliary switch.
- Optional snap-in mounting. (W6)
- Several delay curve options.
- Trip-free operation.

Typical Resistance and Impedance

Current (Amps)	DC Resistance (Ohms)	50/60 Hz. Impedance (Ohms)	400 Hz. Impedance (Ohms)
0.2	90	90	180
1.0	1.2	1.2	2.0
2.0	0.28	0.28	0.50
5.0	0.04	0.04	0.05
10.0	0.013	0.013	0.025
20.0	0.004	0.005	0.0065
30.0	0.0027	0.004	0.004
40.0	0.002	0.002	0.003
50.0	0.0015	0.0015	0.0025

Tolerance: 0.1 - 4.99 ± 15%; 5 - 9.99 ± 20%; 10 - 15 ± 25%; 16 - 30 ± 50%.

Agency Approvals

- UL:** Recognized as Supplementary Protector under UL 1077. File E69543.
- CSA:** Certified as a Supplementary Protector. File LR15734.
- VDE:** Approved to VDE 0642/EN 60 934 (Circuit Breakers for Equipment) License No. 73782.

Mechanical/Environmental Data

- Operating Temperature:** -40°C to +85°C.
- Humidity:** Meets requirements of Mil-STD-202 method 103.
- Shock:** Tested per Mil-STD-202, method 213, test condition C (100g @ 6 ms).
- Vibration:** Tested per Mil-STD-202, method 201, 10-55 Hz., 0.06" (1.52mm) total excursion in 2 planes.
- Fungus And Moisture Resistance:** Special moisture resistant finish applied to all ferrous parts. Plastic parts are made of inherently fungus resistant material.
- Marking:** W6 units have ON and OFF molded on the rocker of rocker actuated units (rocker actuated VDE units have international "1" and "0"). W9 units have ON and OFF molded into the area at the base of the toggle. International "1" and "0" symbols are marked on the toggle for both W6 and W9.
- Mounting:** Panel mounted units are mounted with two #6-32 screws from the front of the panel. Metric models for use with M3 x 0.5 screws are available. Units with snap-in mounting option snap through the front of the panel. To maintain published performance specifications, units should not be mounted more than 90° from their normal upright position.
- Weight:** Approximately 2.5 ounces per pole.

Electrical Data

- Auxiliary Switch:** See Auxiliary Switch Ratings Table 2 for details.
- Calibration:** Breakers will hold 100% of rated current. Breakers may trip between 101% and 124% of rated load (149% for 400 Hz. units and 134% for AC/DC units). Breakers must trip at 125% of rated load and above (150% for 400 Hz. units and 135% for AC/DC units).
- Dielectric Strength:** 50/60 or 400 Hz., 1500V: DC, 1100V.
- Insulation Resistance:** 100 Megohms at 500VDC.
- Endurance:** 10,000 on/off cycles - 6000 at rated load, 4000 at no load. Units tested at six cycles per minute, 1 second on and 9 seconds off at 25°C ambient.

Approvals and Ratings Table 1

W6 Series		UL/CSA (All Circuit Functions)		
Maximum Voltage	Frequency (Hz)	Current Phase	Interrupting Rating (Amps)	Capacity (Amps)
65	DC	-	0.2 - 50	2,000
277	50/60	1	0.2 - 20	5,000
277	50/60	1	21 - 50	2,500
277/480	50/60	3Ø-Wye	0.2 - 20	5,000
250	400	1	0.2 - 20	2,500
250	400	1	21 - 50	1,250
250	400	3Ø-Wye	0.2 - 20	2,500

W6 Series		VDE (Circuit Function X)		
Maximum Voltage	Frequency (Hz)	Current Phase	Interrupting Rating (Amps)	Capacity (Amps)
65	DC	-	0.2-50	2,000
250	50/60	1	0.2-30	5,000
250	50/60	1	31-50	2,000
415/240	50/60	3Ø	0.2-30	5,000

W9 Series		UL/CSA (All Circuit Functions)		
Maximum Voltage	Frequency (Hz)	Current Phase	Interrupting Rating (Amps)	Capacity (Amps)
65	DC	-	0.2 - 50	2,000
277	50/60	1	0.2 - 50	5,000
277/480	50/60	3Ø-Wye	0.2 - 20	5,000
250	400	1	0.2 - 50	2,500
250	400	3Ø-Wye	0.2 - 50	2,500

W9 Series		VDE (Circuit Function X)		
Maximum Voltage	Frequency (Hz)	Current Phase	Interrupting Rating (Amps)	Capacity (Amps)
65	DC	-	0.2-50	2,000
250	50/60	1	0.2-30	5,000
250	50/60	1	31-50	2,000
415/240	50/60	3Ø	0.2-30	5,000

Approvals and Ratings Table 2

UL/CSA			
Switch Number	Voltage 50/60 Hz.	Current (Amps)	Terminals WxTxL
A	125	10	.093 x .020 x .250 (2.36 x .51 x 6.40)

VDE			
Switch Number	Voltage 50/60 Hz.	Current (Amps)	Terminals WxTxL
V1	250	10	.110 x .020 x .280
V2	250	5	(2.79 x .51 x 7.11)
V3	250	0.1	

Time vs. Current Trip Curves For W6 Series and W9 Series

AC 50/60 Hz.

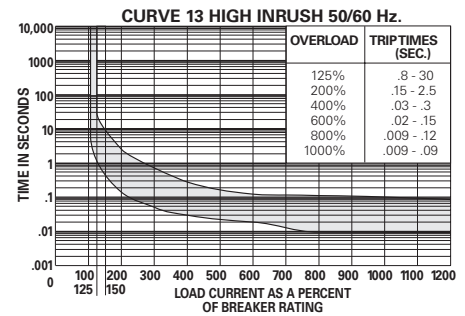
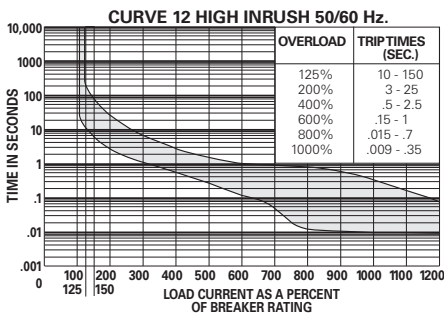
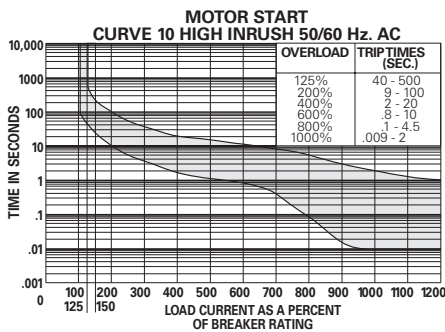
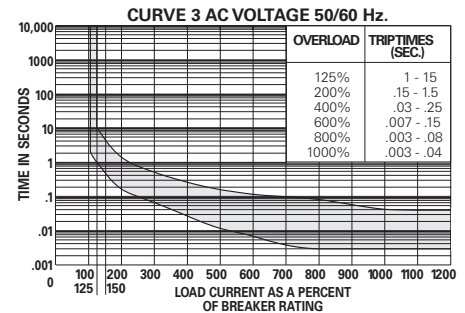
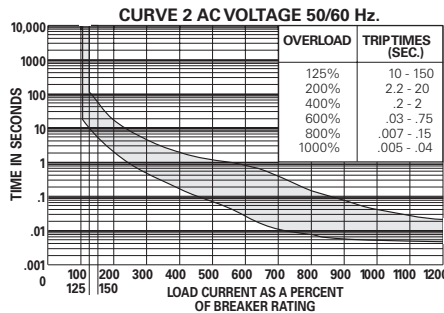
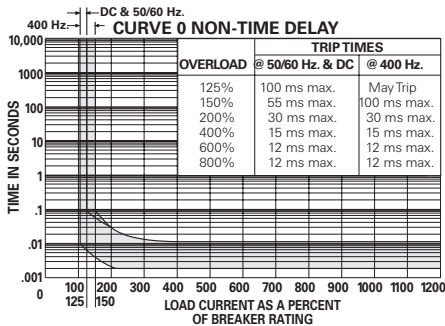

DC

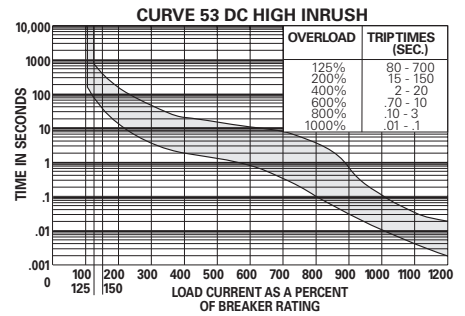
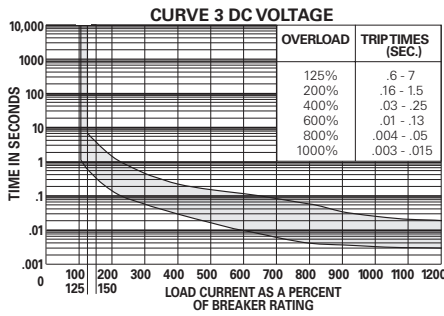
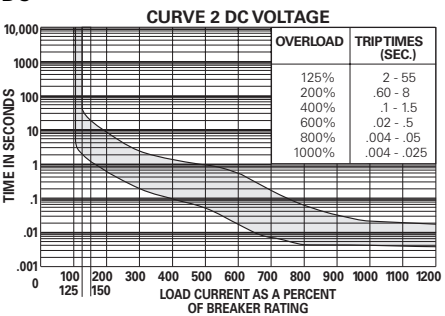

AC/DC

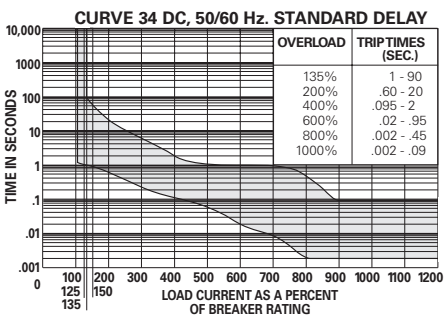

AC 400 Hz.

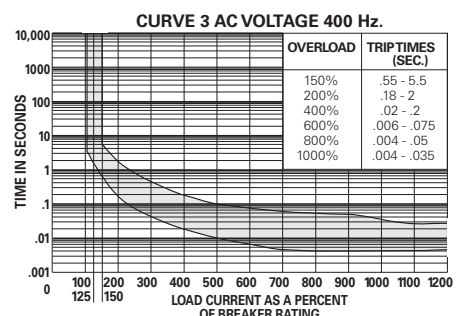
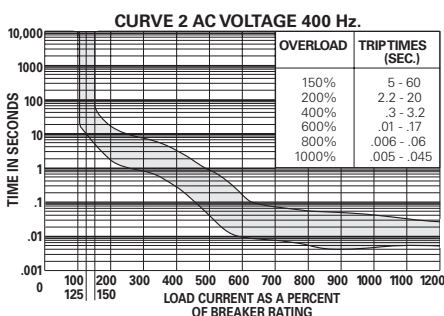

Note:

For instantaneous curves for all voltages refer to Curve 0 Non-Time Delay under the AC 50/60 Hz. heading.

Pulse Tolerance Specifications

Pulse tolerance is defined as a single pulse of a half sine wave (1/2 cycle or 8 milliseconds) that will not trip the breaker. An inertia wheel for increased pulse tolerance is available by specifying "P" after the time delay curve number in the ordering information. The table at right lists pulse tolerance values of standard and inertia delay models.

Voltage	Time Delay Curve	Pulse Tolerance Value	
		Standard	Inertia Delay
AC 50/60 Hz.	2	7.5	18
	3	6	18
	10	18	30
	12	18	30
	13	18	30
AC 400 Hz.	2	6.5	18
	3	5.5	18

To determine pulse tolerance multiply breaker rating by value in table. For example, a 2A breaker with time delay curve 3 has a standard pulse tolerance of 12A (2A x 6). The same breaker with an inertia delay has a pulse tolerance of 36A (2A x 18).

Ordering Information

W6 Series

Typical Part No. ▶														W	67-	X	2	Q	1	2-	20							
1. Circuit Breaker Mounting: W = #6-32 mounting threads. M = M3.0 x 0.5 mounting threads. X = Snap-in mounting. (Not available in rocker actuated models.)																												
2. Number of Poles: 67 = Single pole 68 = Two pole 69 = Three pole 70 = Four pole																												
3. Circuit Function: (Only X is VDE approved) A = Series trip with auxiliary switch (.093" QC) X = Series trip																												
4. Actuator: (One actuator per pole) 1 = Black toggle 3 = Black rocker 5 = Red rocker 9 = Red toggle 2 = White toggle 4 = White rocker 6 = Grey rocker																												
5. Termination: Q = .250" QC (DIN 46 244) 25A Max. VDE S = #8-32 screw T = #10-32 screw Note: "T" termination must be used for all ratings of 31 amps or above.																												
6. Maximum Line Voltage: (See Table 1 for current ranges)																												
UL/CSA TYPES 1 = 277VAC, 50/60 Hz. 2 = 277/480 3 = 250VAC, 400 Hz. 5 = 65VDC 7 = AC/DC 277VAC or 65VDC (Delay curve 34 must be specified.)																												
VDE TYPES 1 = 250VAC, 415/240VAC 5 = 65VDC 7 = AC/DC 250VAC, 415/240VAC, 65VDC (Delay curve 34 must be specified.)																												
7. Time Delay Curve: 0 = Instantaneous 10 = AC high inrush (Motor start) 2 = Standard delay 12 = AC high inrush version of #2 3 = Short delay 13 = AC high inrush version of #3 53 = DC high inrush 34 = Combination AC/DC standard delay Notes: Curves may be specified with increased pulse tolerance for 1/2 cycle by adding "P" after curve. See delay curve section for availability and details.																												
8. Amp Rating: 0.20 0.50 1.0 2.0 3.0 4.0 6.0 7.5 9.0 11.0 15.0 25.0 35.0 45.0 Consult factory for other values. 0.25 0.75 1.5 2.5 3.5 5.0 7.0 8.0 10.0 12.0 20.0 30.0 40.0 50.0																												
9. VDE Approval: (See Table 2 for auxiliary switch ratings) Blank = UL/CSA approved breaker V2 = VDE approved breaker with 5 amp VDE auxiliary switch V = VDE approved breaker without auxiliary switch V3 = VDE approved breaker with 0.1 amp VDE auxiliary switch V1 = VDE approved breaker with 10 amp VDE auxiliary switch																												

Stock Items - We recommend that our authorized distributors stock the following items for immediate delivery.

W67-A2Q12-5	W67-X2Q12-5	W67-X2Q13-1	W67-X2Q13-25	W67-X2Q52-15	W68-X2Q12-5	W68-X2Q12-30	W69-X2Q12-15
W67-A2Q12-10	W67-X2Q12-7	W67-X2Q13-2	W67-X2Q13-30	W67-X2Q52-20	W68-X2Q12-7	W68-X2Q13-15	W69-X2Q12-20
W67-X2Q10-3	W67-X2Q12-10	W67-X2Q13-3	W67-X2Q50-5	W67-X2Q52-30	W68-X2Q12-10	W68-X2Q110-10	W69-X2Q12-25
W67-X2Q10-5	W67-X2Q12-15	W67-X2Q13-10	W67-X2Q50-10	W67-X2Q110-15	W68-X2Q12-15	W68-X2Q110-20	W69-X2Q12-30
W67-X2Q12-2	W67-X2Q12-20	W67-X2Q13-15	W67-X2Q52-5	W67-X2Q110-20	W68-X2Q12-20	W69-X2Q12-5	W69-X2Q110-20
W67-X2Q12-3	W67-X2Q12-30	W67-X2Q13-20	W67-X2Q52-10	W68-X2Q12-3	W68-X2Q12-25	W69-X2Q12-10	W69-X2Q110-30

Ordering Information

W9 Series

Typical Part No. ▶														W	91-	X	1	1	2-	20							
1. Circuit Breaker Mounting: W = #6-32 mounting threads. M = M3.0 x 0.5 mounting threads.																											
2. Number of Poles: 91 = Single pole 92 = Two pole 93 = Three pole 94 = Four pole																											
3. Circuit Function: (Only X is VDE approved) A = Series trip with auxiliary switch (.093" QC) X = Series trip																											
4. Actuator: (One actuator per pole): 1 = Black toggle 2 = White toggle																											
5. Maximum Line Voltage: (See Table 1 for current ranges)																											
UL/CSA TYPES 1 = 277VAC, 50/60 Hz. 2 = 277/480 3 = 250VAC, 400 Hz. 5 = 65VDC 7 = AC/DC 277VAC or 65VDC (Delay curve 34 must be specified.)																											
VDE TYPES 1 = 250VAC, 415/240VAC 5 = 65VDC 7 = AC/DC 250VAC, 415/240VAC, 65VDC (Delay curve 34 must be specified.)																											
6. Time Delay Curve: 0 = Instantaneous 10 = AC high inrush (Motor start) 2 = Standard delay 12 = AC high inrush version of #2 3 = Short delay 13 = AC high inrush version of #3 53 = DC high inrush 34 = Combination AC/DC standard delay Notes: Curves may be specified with increased pulse tolerance for 1/2 cycle by adding "P" after curve. See delay curve section for availability and details.																											
7. Amp Rating: 0.20 0.75 2.0 3.5 6.0 8.0 11.0 20.0 35.0 50.0 0.25 1.0 2.5 4.0 7.0 9.0 12.0 25.0 40.0 Consult factory for other values 0.50 1.5 3.0 5.0 7.5 10.0 15.0 30.0 45.0																											
8. VDE Approval: (See Table 2 for auxiliary switch ratings) Blank = UL/CSA approved breaker V2 = VDE approved breaker with 5 amp VDE auxiliary switch V = VDE approved breaker without auxiliary switch V3 = VDE approved breaker with 0.1 amp VDE auxiliary switch V1 = VDE approved breaker with 10 amp VDE auxiliary switch																											

Stock Items - We recommend that our authorized distributors stock the following items for immediate delivery.

W91-X112-1	W91-X112-2	W91-X112-3	W91-X112-5	W91-X112-7	W91-X112-10	W91-X112-15	W91-X112-20	W91-X112-30	W91-X112-40	W91-X112-50	W91-X112-75	W91-X112-100	W91-X112-150	W91-X112-200	W91-X112-300	W91-X112-400	W91-X112-500	W91-X112-600	W91-X112-750	W91-X112-1000	W91-X112-1500	W91-X112-2000	W91-X112-3000	W91-X112-4000	W91-X112-5000	W91-X112-6000	W91-X112-7500	W91-X112-10000	W91-X112-15000	W91-X112-20000	W91-X112-30000	W91-X112-40000	W91-X112-50000	W91-X112-60000	W91-X112-75000	W91-X112-100000
------------	------------	------------	------------	------------	-------------	-------------	-------------	-------------	-------------	-------------	-------------	--------------	--------------	--------------	--------------	--------------	--------------	--------------	--------------	---------------	---------------	---------------	---------------	---------------	---------------	---------------	---------------	----------------	----------------	----------------	----------------	----------------	----------------	----------------	----------------	-----------------

Outline Dimensions - Toggle Actuator Models.

W6 Series

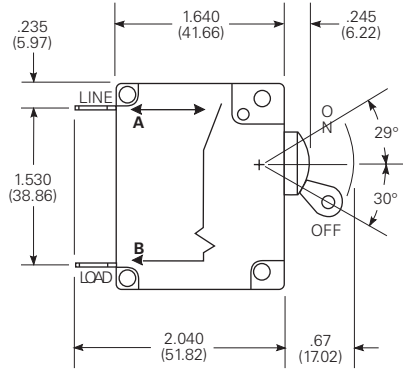

Panel Mounting Cutout

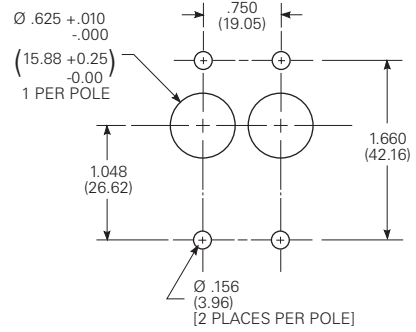

W6 Series

1 Pole

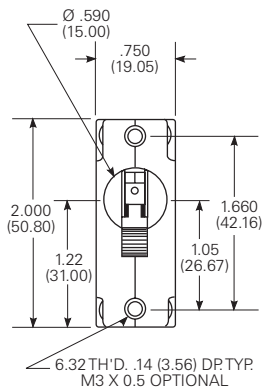

2 Pole

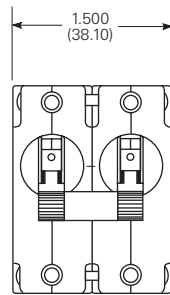

3 Pole

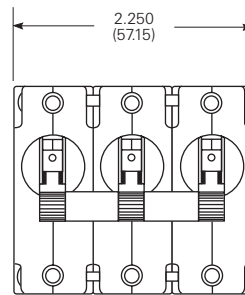

4 Pole

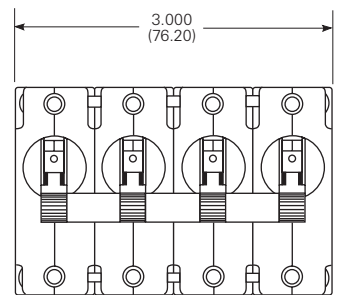

Note:
Multi-pole models furnished with separate handle tie hardware.

VDE Models
W/Screw Terminals

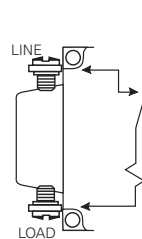

UL/CSA Models
W/Screw Terminals

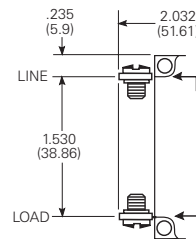

UL/CSA/VDE Models
W/Aux. Switch

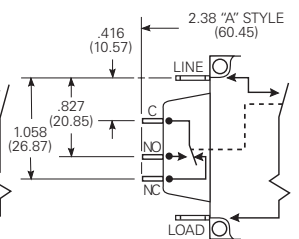

Notes:

- Terminal protrusion dimensions are referenced from back of mounting panel.
- Main terminals are male quick connect type .250 (6.35) wide x .031 (.79) thick x .377 (9.58) long. Optional 8-32 x .250 (6.35) or 10-32 x .250 (6.35) screw type.
- Panel mounting cutout detail mtg. detail tol.: ± .005 (.13) unless noted. Add additional cutouts to correspond to number of poles. Outline drawing tolerance ± .015 (.38) unless noted. Dimensions in brackets () are in millimeters.

Outline Dimensions - Rocker Actuator Models

W6 Series

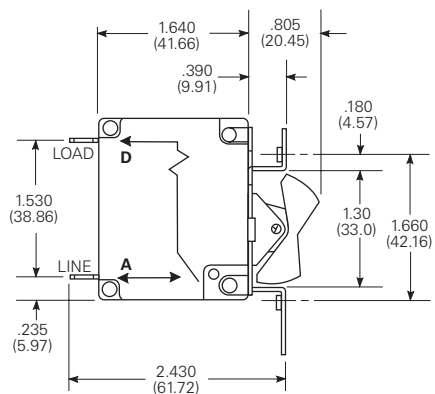

1 Pole

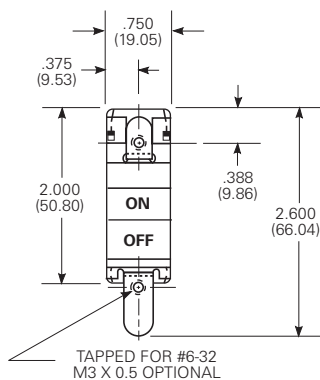

2, 3 & 4 Pole

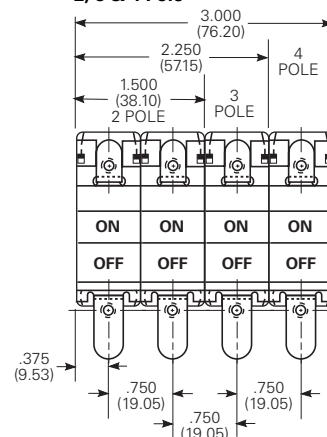

Panel Mounting Cutout

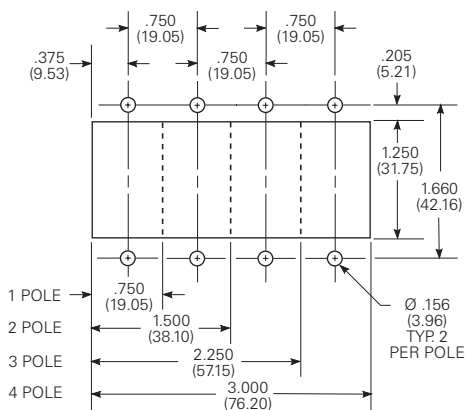

VDE Rocker Marking

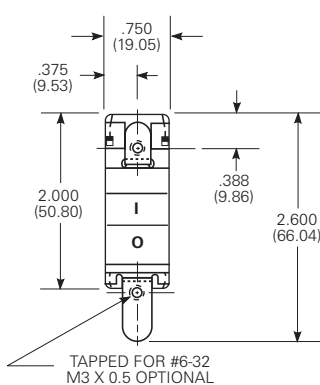

Notes:

1. Outline drawing tolerance $\pm .015$ (.38) unless noted. Dimensions in brackets () are in millimeters.
2. Mounting Detail Tol.: $\pm .005$ (.13) unless noted

Outline Dimensions - Snap-in Mounted Models

W6 Series

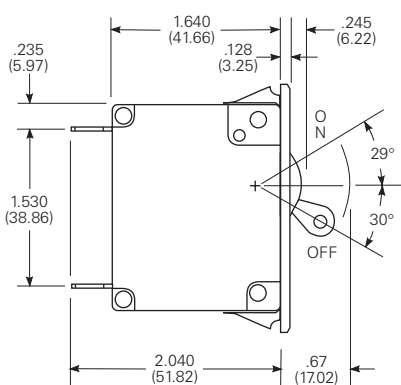

1 Pole

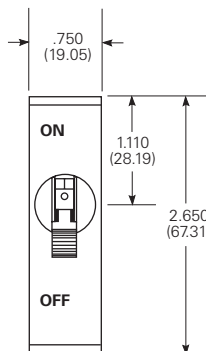

2 Pole

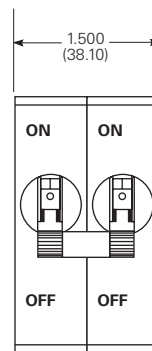

3 Pole

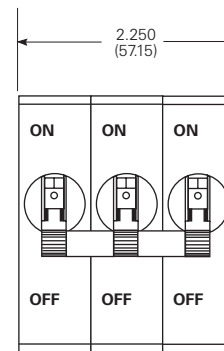

Panel Mounting Cutout

1 Pole

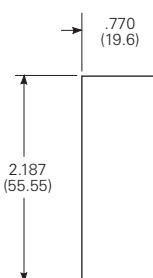

2 Pole

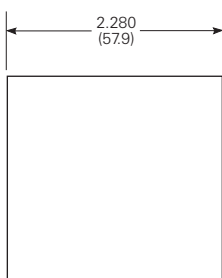

3 Pole

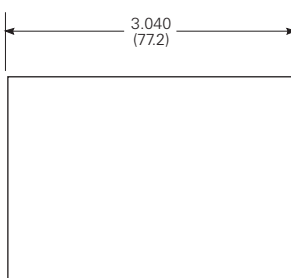

4 Pole

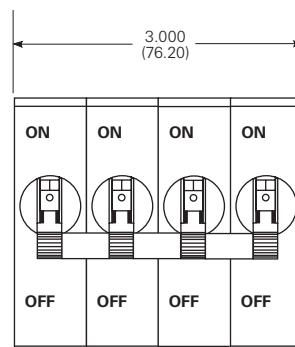

Notes:

- Mounting Detail Tol.: $\pm .005$ (.13) unless noted
 Panel Thickness: .047 (1.2) to .110 (2.8)

