

High Voltage Fast-Switching NPN Power Transistor

Features

- Very High Switching Speed
- Minimum Lot-to-Lot h_{FE} Variation
- Wide Reverse Bias SOA
- Built-in freewheeling diode

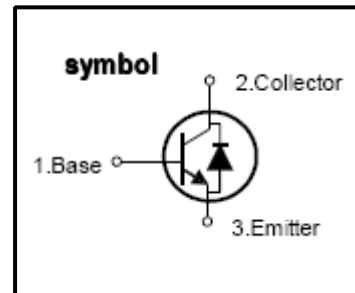

General Description

This Device is designed for high voltage, High speed switching characteristics required such as lighting system, switching mode power supply.

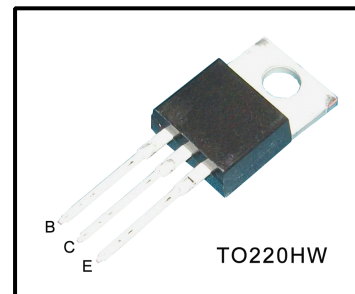

Absolute Maximum Ratings

Symbol	Paramete	Test Conditions	Value	Units
V_{CES}	Collector-Emitter Voltage	$V_{BE} = 0$	700	V
V_{CEO}	Collector-Emitter Voltage	$I_B = 0$	400	V
V_{EBO}	Emitter-Base Voltage	$I_C = 0$	9.0	V
I_C	Collector Current		4.0	A
I_{CP}	Collector pulse Current		8.0	A
I_B	Base Current		2.0	A
I_{BM}	Base Peak Current	$t_P = 5ms$	4.0	A
P_C	Total Dissipation at $T_c = 25^{\circ}C$		75	W
	Total Dissipation at $T_a = 25^{\circ}C$		1.8	
T_J	Operation Junction Temperature		- 40 ~ 150	$^{\circ}C$
T_{STG}	Storage Temperature		- 40 ~ 150	$^{\circ}C$

T_c : Case temperature (good cooling)

T_a : Ambient temperature (without heat sink)

Thermal Characteristics

Symbol	Parameter	Value	Units
$R_{\theta JC}$	Thermal Resistance Junction to Case	1.67	$^{\circ}C/W$
$R_{\theta JA}$	Thermal Resistance Junction to Ambient	62.5	$^{\circ}C/W$

Electrical Characteristics ($T_C=25^{\circ}\text{C}$ unless otherwise noted)

Symbol	Parameter	Test Conditions	Value			Units
			Min	Typ	Max	
I_{CEV}	Collector Cut-off Current ($V_{BE} = -1.5\text{V}$)	$V_{CE} = 700\text{V}$	-	-	1.0	mA
		$V_{CE} = 700\text{V}, T_C = 100^{\circ}\text{C}$	-	-	5.0	
$V_{CEO(SUS)}$	Collector-Emitter Sustaining Voltage	$I_B = 0, I_C = 10\text{mA}$	400	-	-	V
$V_{CE(sat)}$	Collector-Emitter Saturation Voltage	$I_C = 1.0\text{A}, I_B = 0.2\text{A}$	-	-	0.5	V
		$I_C = 2.0\text{A}, I_B = 0.5\text{A}$	-	-	0.6	
		$I_C = 4.0\text{A}, I_B = 1.0\text{A}$	-	-	1.0	
$V_{BE(sat)}$	Base-Emitter Saturation Voltage	$I_C = 1.0\text{A}, I_B = 0.2\text{A}$	-	-	1.2	V
		$I_C = 2.0\text{A}, I_B = 0.5\text{A}$	-	-	1.6	
h_{FE}	DC Current Gain	$I_C = 1.0\text{A}, V_{CE} = 5\text{V}$	10		40	
		$I_C = 2.0\text{A}, V_{CE} = 5\text{V}$	10		30	
t_s	Storage Time	$I_C = 2.0\text{A}, V_{CC} = 125\text{V}$	-	-	3.6	μs
t_f	Fall Time	$I_{B1} = 0.4\text{A}, I_{B2} = -0.4\text{A}$ $T_P = 25\mu\text{s}$	-	-	1.6	
f_T	Current Gain Bandwidth Product	$I_C=0.5\text{A}, V_{CE}=10\text{V}$	4	-	-	MHz
V_F	Diode Forward Voltage	$I_F=2\text{A}$	-	-	2.5	V
C_{OB}	Output Capacitance	$I_C=0.5\text{A}, V_{CE}=10\text{V}$	-	6.5		pF

Note:

Pulse Test : Pulse width 300, Duty cycle 2%

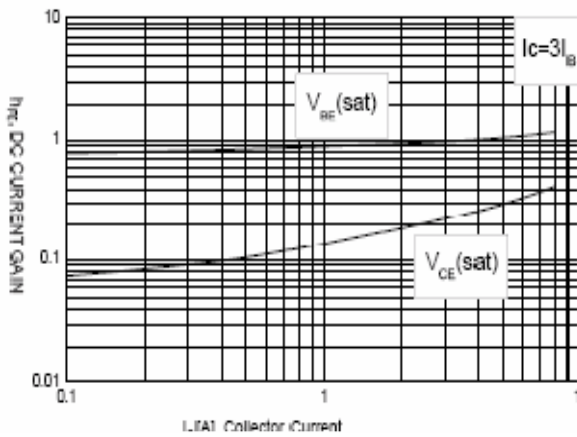

Fig. 1 DC Current Gain

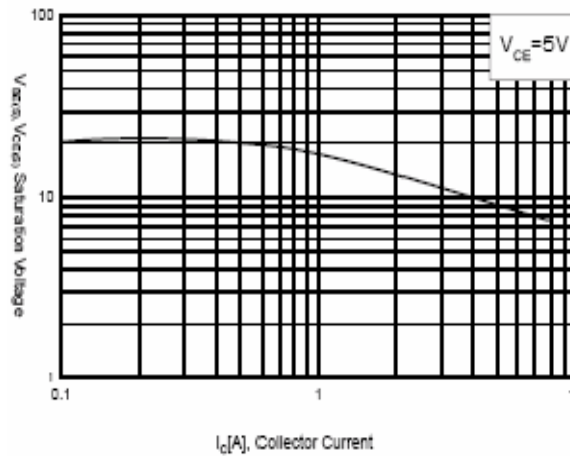

Fig. 2 Saturation Voltage

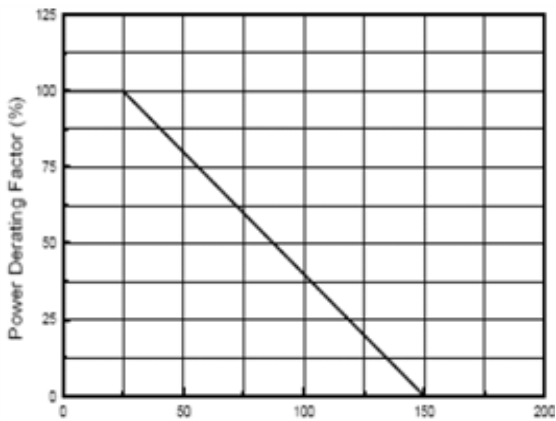

Fig. 3 Power Derating

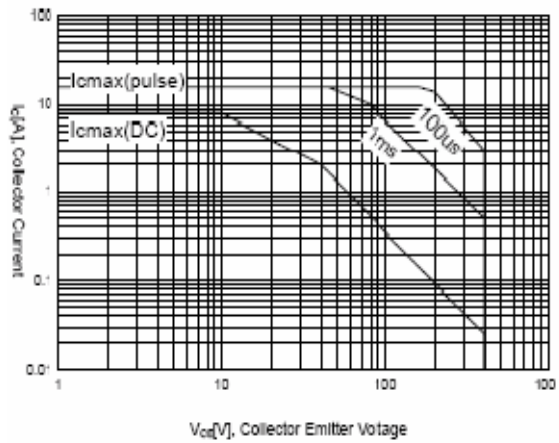

Fig. 4 Safe Operation Area

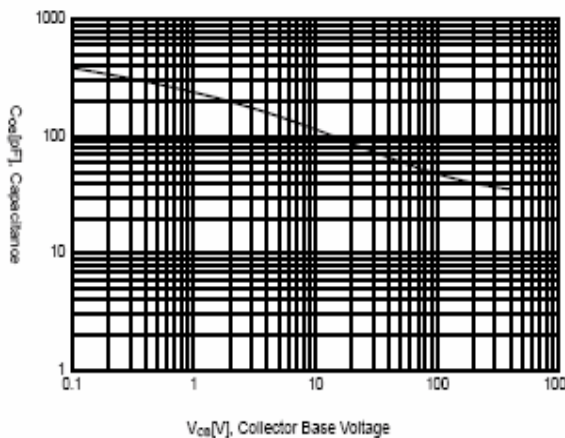
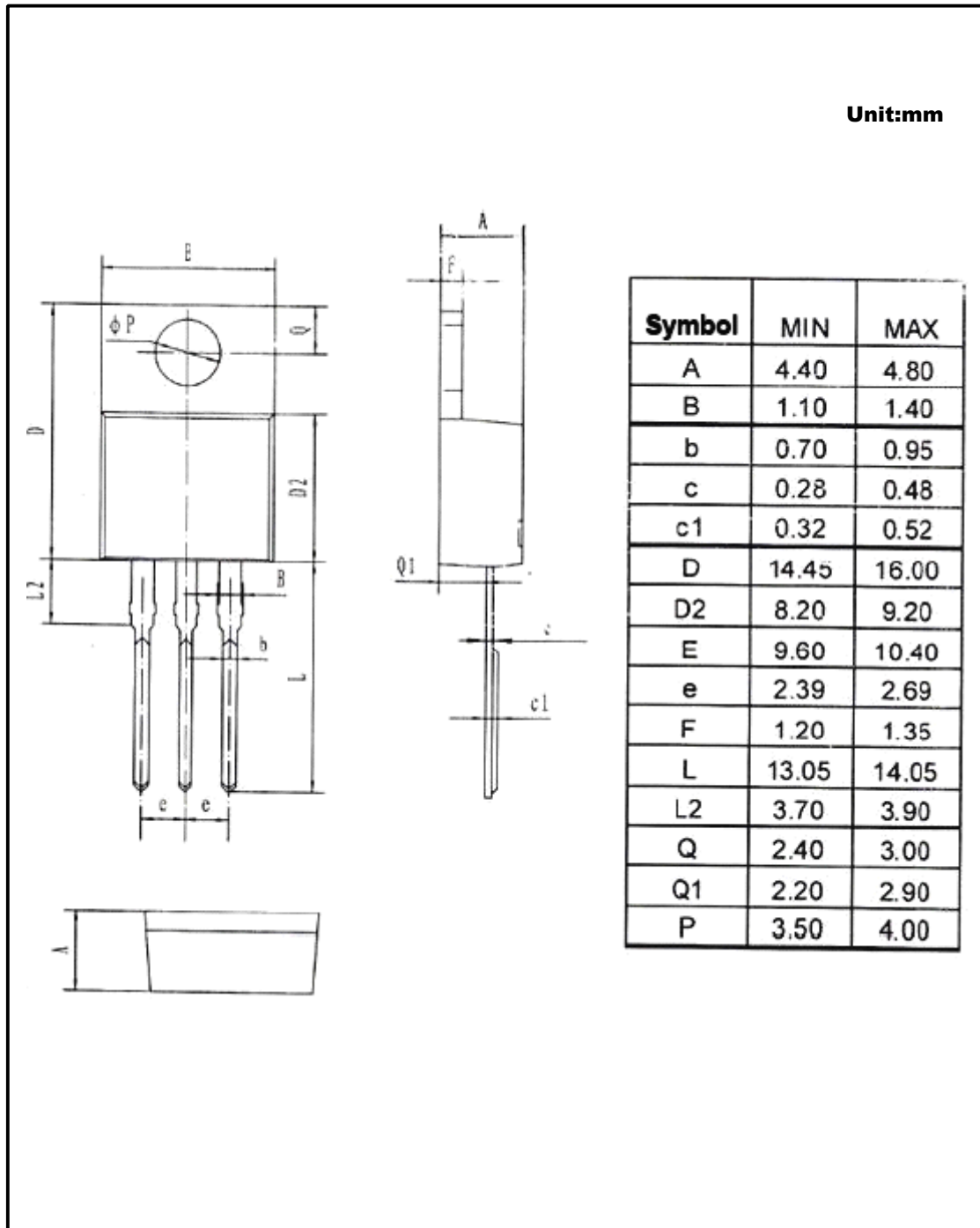

Fig. 5 Collect output capacitance

TO-220HW Package Dimension

Unit:mm



Symbol	MIN	MAX
A	4.40	4.80
B	1.10	1.40
b	0.70	0.95
c	0.28	0.48
c1	0.32	0.52
D	14.45	16.00
D2	8.20	9.20
E	9.60	10.40
e	2.39	2.69
F	1.20	1.35
L	13.05	14.05
L2	3.70	3.90
Q	2.40	3.00
Q1	2.20	2.90
P	3.50	4.00