

Silicon Controlled Rectifiers

Features

- Repetitive Peak Off-State Voltage:600V
- R.M.S On-State Current ($I_{T(RMS)}=20A$)
- Low On-State Voltage(1.3V(Typ.)@ I_{TM})
- Non-isolaed Type

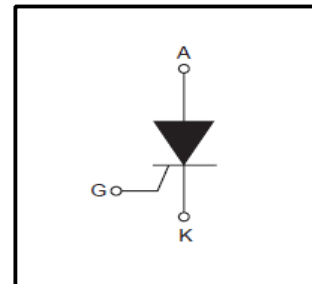

General Description

Standard gate triggering SCR is fully isolated package suitable for the application where requiring high bidirectional blocking voltage capability and also suitable for over voltage protection ,motor control circuit in power tool, inrush current limit circuit and heating control system



Absolute Maximum Ratings ($T_J= 25^{\circ}C$ unless otherwise specified)

| Symbol | Parameter | Condition | Value | Units |
|--------------|---|---|---------|-------------|
| V_{DRM} | Repetitive Peak Off-State Voltage | | 600 | V |
| $I_{T(AV)}$ | Average On-State Current | Half Sine Wave: $T_C=102^{\circ}C$ | 13 | A |
| $I_{T(RMS)}$ | R.M.S On-State Current | 180°conduction Angle | 20 | A |
| I_{TSM} | Surge on-state Current | 1/2 Cycle,60Hz,Sine Wave Non-Repetitive | 220 | A |
| I^2t | I^2t for Fusing | $t=8.3ms$ | 242 | A^2s |
| di/dt | Critical rate of rise of on-state current | | 50 | $A/\mu s$ |
| P_{GM} | Forward Peak Gate Power Dissipation | | 20 | W |
| $P_{G(AV)}$ | Forward Average Gate Power Dissipation | Over any 20ms period | 1 | W |
| I_{FGM} | Forward Peak Gate Current | | 5 | A |
| V_{RGM} | Reverse Peak Gate Voltage | | 5.0 | V |
| T_J | Operating Junction Temperature | | -40~125 | $^{\circ}C$ |
| T_{STG} | Storage Temperature | | -40~150 | $^{\circ}C$ |

Thermal Characteristics

| Symbol | Parameter | Value | | | Units |
|-----------------|--|-------|-----|-----|---------------|
| | | Min | Typ | Max | |
| $R_{\theta Jc}$ | Thermal Resistance Junction to Case | - | - | 1.1 | $^{\circ}C/W$ |
| $R_{\theta JA}$ | Thermal Resistance Junction to Ambient | - | - | 60 | $^{\circ}C/W$ |

Electrical Characteristics (T_C=25°C, unless otherwise noted)

| Symbol | Parameter | Test Conditions | Value | | | Units |
|------------------|---|---|-------|-----|-----|-------|
| | | | Min | Typ | Max | |
| I _{DRM} | Repetitive Peak Off-State Current | V _{AK} =V _{DRM} T _C =25°C | - | - | 10 | μA |
| | | T _C =125°C | - | - | 200 | μA |
| V _{TM} | Peak On-State Voltage (1) | I _{TM} =20A, t _p =380μs | - | 1.3 | 1.6 | V |
| I _{GT} | Gate Trigger Current (2) | V _{AK} =6V(DC), R _L =10Ω T _C =25°C | - | - | 15 | mA |
| V _{GT} | Gate Trigger Voltage (2) | V _D =6V(DC), R _L =10Ω T _C =25°C | - | - | 1.5 | V |
| V _{GD} | Non-Trigger Gate Voltage (1) | V _{AK} =12V, R _L =100Ω T _C =125°C | 0.2 | - | - | V |
| dv/dt | Critical Rate of Rise Off-State Voltage | Linear slope up to V _D =67% V _{DRM} , gate open T _J =125°C | 200 | - | - | V/μs |
| I _H | Holding Current | I _T =100mA, Gate Open T _C =25°C | - | - | 20 | mA |

***Notes:**

1 Pulse Width ≤1.0ms, Duty cycle ≤1%

2 R_{GK} Current is not Included in measurement.

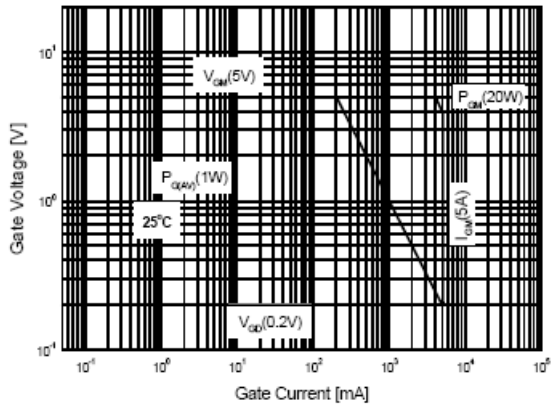

Fig.1 Gate Characteristics

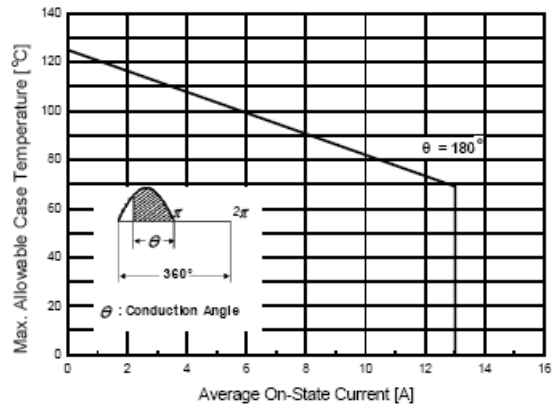

Fig.2 Maximum Case Temperature

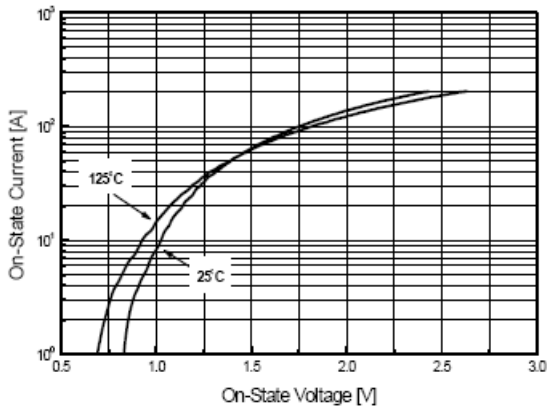

Fig.3 Typical Forward Voltage

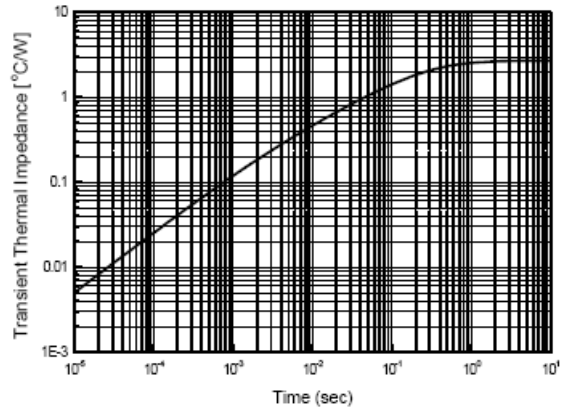

Fig.4 Thermal Response

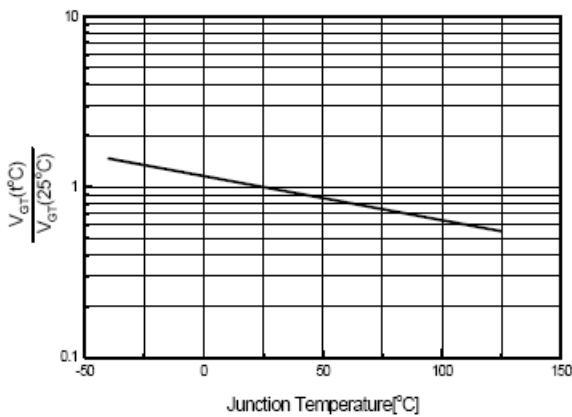

Fig.5 Typical Gate Trigger Voltage vs. Junction Temperature

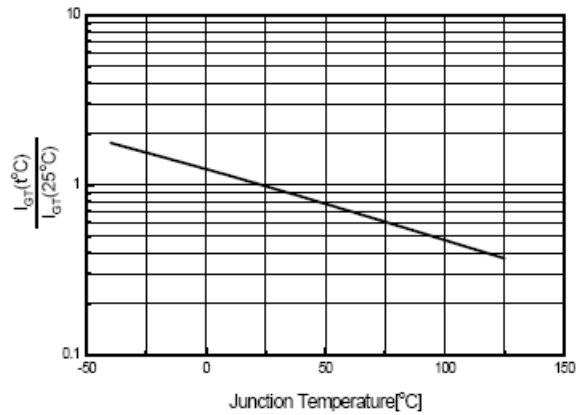

Fig.6 Typical Gate Trigger current vs. Junction Temperature

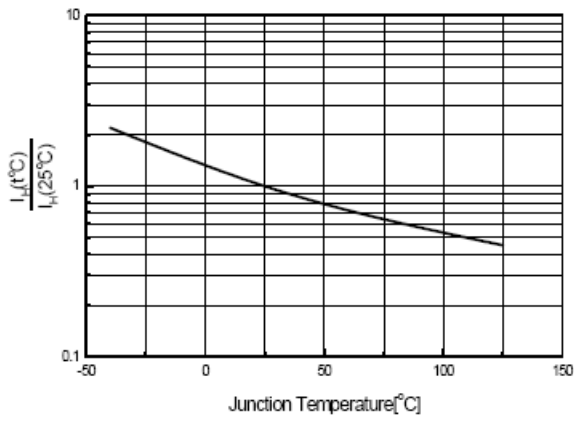

Fig.7 Typical Holding Current

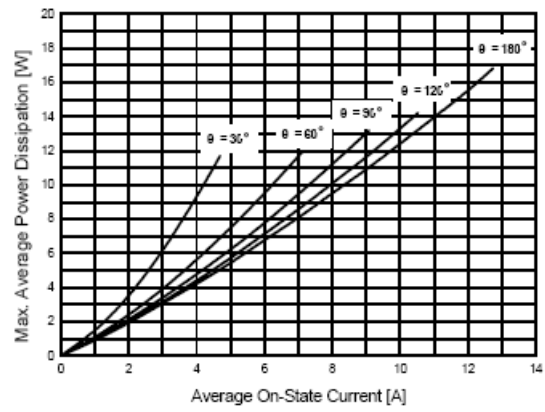

Fig.8 Power Dissipation

TO-252 Package Dimension

Unit: mm

