

WCMA2008U1X

256K x 8 Static RAM

Features

- **High Speed**
— 70ns availability
- **Voltage range**
— 2.7V–3.6V
- **Ultra low active power**
— Typical active current: 1 mA @ f = 1MHz
— Typical active current: 7 mA @ f = f_{max} (70ns speed)
- **Low standby power**
- **Easy memory expansion with \overline{CE}_1 , \overline{CE}_2 , and \overline{OE} features**
- **Automatic power-down when deselected**
- **CMOS for optimum speed/power**

Functional Description

The WCMA2008U1X is a high-performance CMOS static RAM organized as 256K words by 8 bits. This device features advanced circuit design to provide ultra-low active current. This device is ideal for portable applications. The device also has an automatic power-down feature that significantly reduces

power consumption by 80% when addresses are not toggling. The device can be put into standby mode reducing power consumption by more than 99% when deselected (\overline{CE}_1 HIGH or \overline{CE}_2 LOW).

Writing to the device is accomplished by taking Chip Enable (\overline{CE}_1) and Write Enable (\overline{WE}) inputs LOW and Chip Enable 2 (\overline{CE}_2) HIGH. Data on the eight I/O pins (I/O₀ through I/O₇) is then written into the location specified on the address pins (A₀ through A₁₇).

Reading from the device is accomplished by taking Chip Enable (\overline{CE}_1) and Output Enable (\overline{OE}) LOW while forcing Write Enable (\overline{WE}) and Chip Enable 2 (\overline{CE}_2) HIGH. Under these conditions, the contents of the memory location specified by the address pins will appear on the I/O pins.

The eight input/output pins (I/O₀ through I/O₇) are placed in a high-impedance state when the device is deselected (\overline{CE}_1 HIGH or \overline{CE}_2 LOW), the outputs are disabled (\overline{OE} HIGH), or during a write operation (\overline{CE}_1 LOW and \overline{CE}_2 HIGH and \overline{WE} LOW).

The WCMA2008U1X is available in a 36-ball FBGA package.

Logic Block Diagram

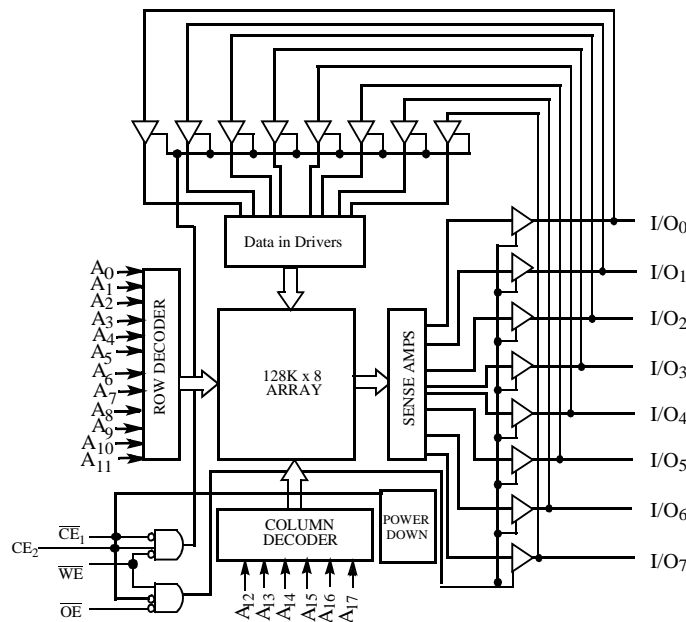

Pin Configurations

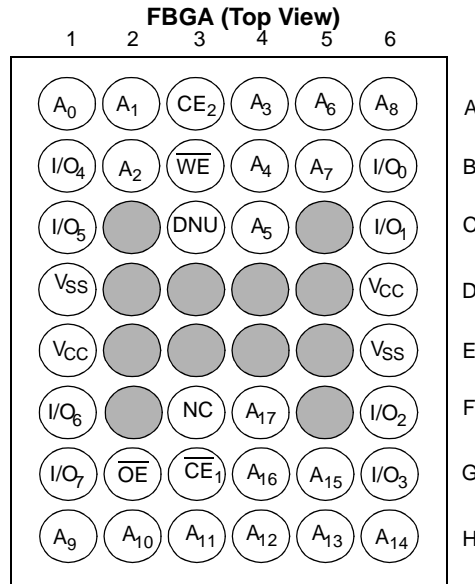

Maximum Ratings

(Above which the useful life may be impaired. For user guidelines, not tested.)

Storage Temperature-65°C to +150°C
 Ambient Temperature with Power Applied.....55°C to +125°C
 Supply Voltage to Ground Potential.....-0.5V to +4.6V

DC Voltage Applied to Outputs

in High Z State^[1].....0.5V to V_{CC} + 0.5V

DC Input Voltage^[1].....-0.5V to V_{CC} + 0.5V

Output Current into Outputs (LOW).....20 mA

Static Discharge Voltage>2001V
 (per MIL-STD-883, Method 3015)

Latch-Up Current>200 mA

Operating Range

Product	Range	Ambient Temperature	V _{CC}
WCMA2008U1X	Industrial	-40°C to +85°C	2.7V to 3.6V

Product Portfolio

Product	V _{CC} Range			Speed	Power Dissipation (Industrial)					
					Operating, I _{CC}				Standby (I _{SB2})	
	f = 1 MHz		f = f _{max}							
	Min.	Typ. ^[2]	Max.		Typ. ^[2]	Max.	Typ. ^[2]	Max.	Typ. ^[2]	Max.
WCMA2008U1X	2.7V	3.0V	3.6V	70 ns	1 mA	2 mA	7 mA	15 mA	1 μA	30 μA

Notes:

- V_{IL(min.)} = -2.0V for pulse durations less than 20 ns.
- Typical values are included for reference only and are not guaranteed or tested. Typical values are measured at V_{CC} = V_{CC(typ.)}, T_A = 25°C.

Electrical Characteristics Over the Operating Range

Parameter	Description	Test Conditions	WCMA2008U1X-70			Unit
			Min.	Typ. ^[2]	Max.	
V _{OH}	Output HIGH Voltage	I _{OH} = -1.0 mA V _{CC} = 2.7V	2.4			V
V _{OL}	Output LOW Voltage	I _{OL} = 2.1 mA V _{CC} = 2.7V			0.4	V
V _{IH}	Input HIGH Voltage		2.2		V _{CC} + 0.5V	V
V _{IL}	Input LOW Voltage		-0.5		0.8	V
I _{IX}	Input Leakage Current	GND ≤ V _I ≤ V _{CC}	-1		+1	μA
I _{OZ}	Output Leakage Current	GND ≤ V _O ≤ V _{CC} , Output Disabled	-1		+1	μA
I _{CC}	V _{CC} Operating Supply Current	f = f _{MAX} = 1/t _{RC} V _{CC} = 3.6V I _{OUT} = 0 mA CMOS Levels		7	15	mA
		f = 1 MHz		1	2	
I _{SB1}	Automatic CE Power-Down Current—TTL Inputs	Max. V _{CC} , CE ₁ ≥ V _{IH} , CE ₂ < V _{IH} V _{IN} ≥ V _{IH} or V _{IN} ≤ V _{IL} , f = f _{MAX}			100	μA
I _{SB2}	Automatic CE Power-Down Current—CMOS Inputs	Max. V _{CC} , CE ₁ ≥ V _{CC} - 0.3V, CE ₂ < 0.3V V _{IN} ≥ V _{CC} - 0.3V or V _{IN} ≤ 0.3V, f = 0		1	15	

Capacitance^[3]

Parameter	Description	Test Conditions	Max.	Unit
C _{IN}	Input Capacitance	T _A = 25°C, f = 1 MHz, V _{CC} = V _{CC(typ)}	6	pF
C _{OUT}	Output Capacitance		8	pF

Thermal Resistance

www.DataSheet4U.com

Description	Test Conditions	Symbol	BGA	Unit
Thermal Resistance ^[3] (Junction to Ambient)	Still Air, soldered on a 4.25 x 1.125 inch, 4-layer printed circuit board	θ _{JA}	55	°C/W
Thermal Resistance ^[3] (Junction to Case)		θ _{JC}	16	°C/W

Note:

- Tested initially and after any design or process changes that may affect these parameters.

AC Test Loads and Waveforms

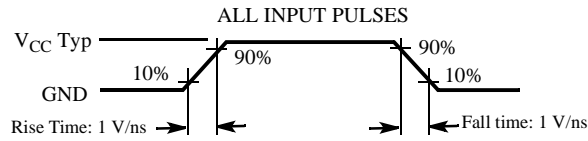
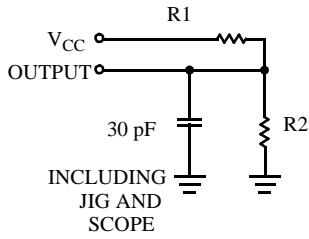

Equivalent to: THÉVENIN EQUIVALENT

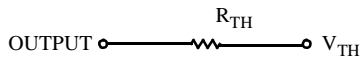

Parameters	3.3V	Unit
R1	1105	Ohms
R2	1550	Ohms
R _{TH}	645	Ohms
V _{TH}	1.75	Volts

Data Retention Characteristics (Over the Operating Range)

Parameter	Description	Conditions	Min.	Typ. ^[2]	Max.	Unit
V _{DR}	V _{CC} for Data Retention		1.0		3.6	V
I _{CCDR}	Data Retention Current	V _{CC} = 1.0V, $\overline{CE}_1 \geq V_{CC} - 0.3V$, CE ₂ < 0.3V V _{IN} ≥ V _{CC} - 0.3V or V _{IN} ≤ 0.3V		0.1	5	μA
t _{CDR} ^[3]	Chip Deselect to Data Retention Time		0			ns
t _R ^[4]	Operation Recovery Time		100			ns

Data Retention Waveform

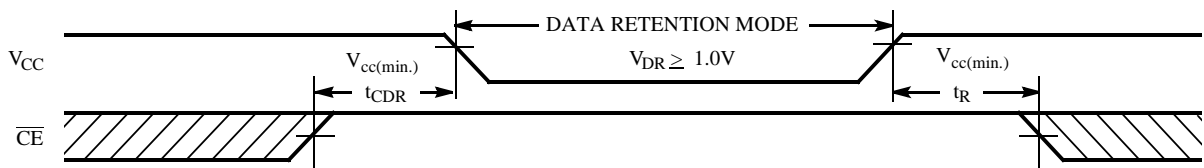

Note:

- Full Device AC operation requires linear V_{CC} ramp from V_{DR} to V_{CC(min.)} ≥ 100 μs or stable at V_{CC(min.)} ≥ 100 μs.



Switching Characteristics Over the Operating Range^[5]

Parameter	Description	WCMA2008U1X-70		Unit
		Min.	Max.	
READ CYCLE				
t _{RC}	Read Cycle Time	70		ns
t _{AA}	Address to Data Valid		70	ns
t _{OHA}	Data Hold from Address Change	10		ns
t _{ACE}	\overline{CE}_1 LOW and CE ₂ HIGH to Data Valid		70	ns
t _{DOE}	\overline{OE} LOW to Data Valid		35	ns
t _{LZOE}	\overline{OE} LOW to Low Z ^[6]	5		ns
t _{HZOE}	\overline{OE} HIGH to High Z ^[6, 7]		25	ns
t _{LZCE}	\overline{CE}_1 LOW and CE ₂ HIGH to Low Z ^[6]	10		ns
t _{HZCE}	\overline{CE}_1 HIGH or CE ₂ LOW to High Z ^[6, 7]		25	ns
t _{PU}	\overline{CE}_1 LOW and CE ₂ HIGH to Power-Up	0		ns
t _{PD}	\overline{CE}_1 HIGH or CE ₂ LOW to Power-Down		70	ns
WRITE CYCLE^[8,]				
t _{WC}	Write Cycle Time	70		ns
t _{SCE}	\overline{CE}_1 LOW and CE ₂ HIGH to Write End	60		ns
t _{AW}	Address Set-Up to Write End	60		ns
t _{HA}	Address Hold from Write End	0		ns
t _{SA}	Address Set-Up to Write Start	0		ns
t _{PWE}	\overline{WE} Pulse Width	50		ns
t _{SD}	Data Set-Up to Write End	30		ns
t _{HD}	Data Hold from Write End	0		ns
t _{HZWE}	\overline{WE} LOW to High Z ^[6, 7]		25	ns
t _{LZWE}	\overline{WE} HIGH to Low Z ^[6]	10		ns

www.DataSheet4U.com

- Notes:**
5. Test conditions assume signal transition time of 5 ns or less, timing reference levels of $V_{CC(typ.)}/2$, input pulse levels of 0 to $V_{CC(typ.)}$, and output loading of the specified I_{OL}/I_{OH} and 30 pF load capacitance.
 6. At any given temperature and voltage condition, t_{HZCE} is less than t_{LZCE}, t_{HZOE} is less than t_{LZOE}, and t_{HZWE} is less than t_{LZWE} for any given device.
 7. t_{HZOE}, t_{HZCE}, and t_{HZWE} transitions are measured when the outputs enter a high impedance state.
 8. The internal write time of the memory is defined by the overlap of \overline{WE} , $\overline{CE}_1 = V_{IL}$, and CE₂ = V_{IH}. All signals must be ACTIVE to initiate a write and any of these signals can terminate a write by going INACTIVE. The data input set-up and hold timing should be referenced to the edge of the signal that terminates the write.

Switching Waveforms

Read Cycle No. 1 (Address Transition Controlled) [9, 10]

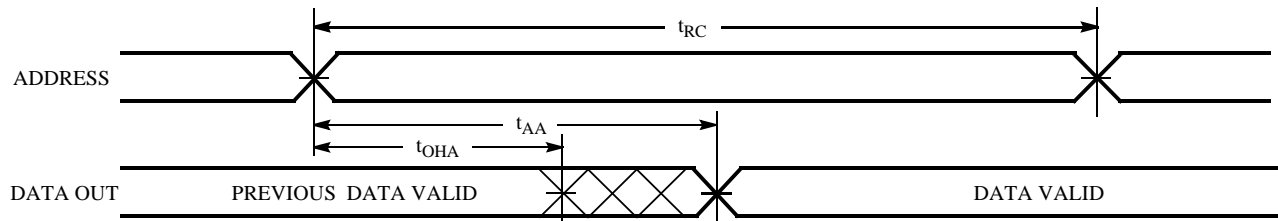

Read Cycle No. 2 (\overline{OE} Controlled) [10, 11]

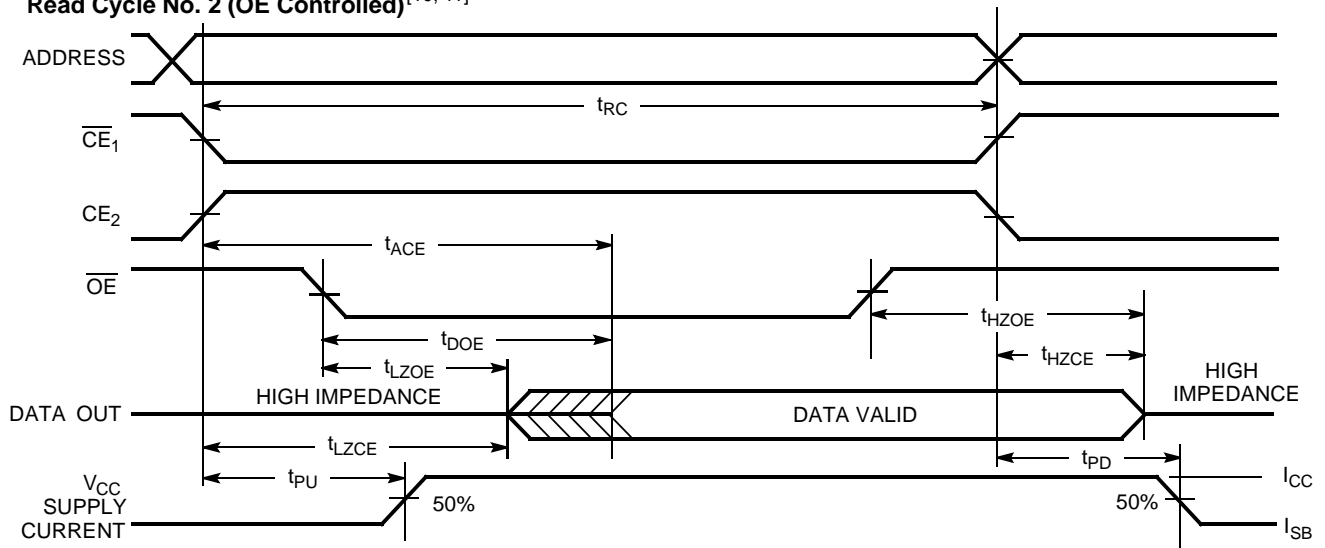

www.DataSheet4U.com

- 9. Device is continuously selected. \overline{OE} , $\overline{CE}_1 = V_{IL}$, $CE_2 = V_{IH}$.
- 10. \overline{WE} is HIGH for read cycle.
- 11. Address valid prior to or coincident with \overline{CE} transition LOW.

Switching Waveforms (continued)

Write Cycle No. 1 (\overline{WE} Controlled) [8, 12, 14]

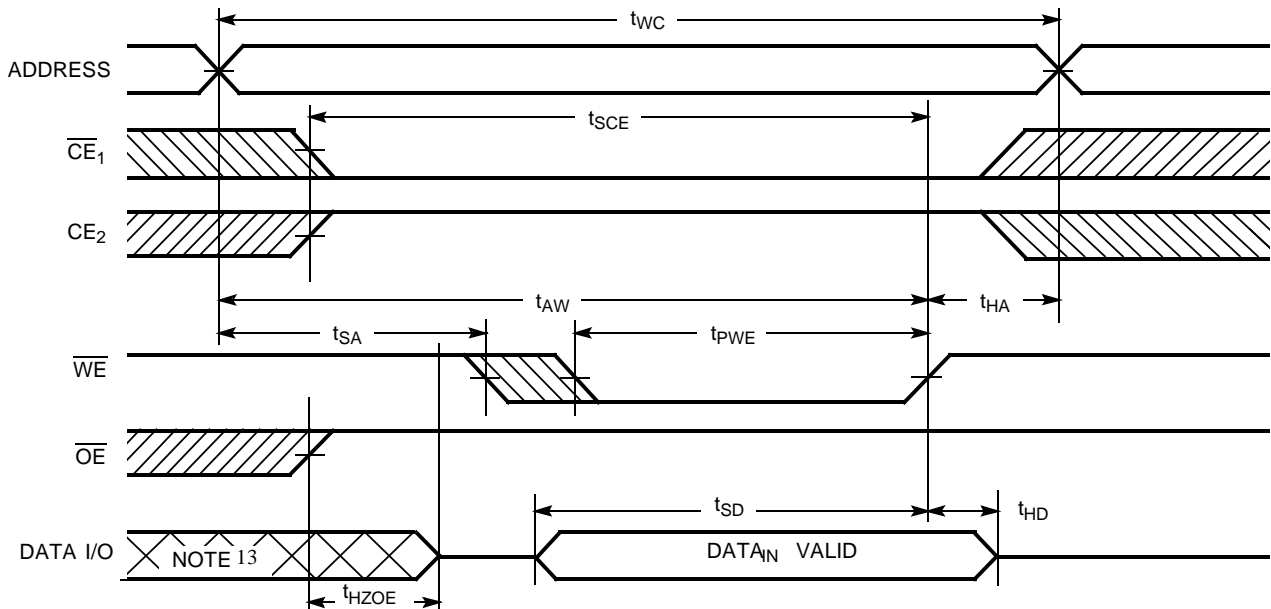

Write Cycle No. 2 (\overline{CE}_1 or \overline{CE}_2 Controlled) [8, 12, 14]

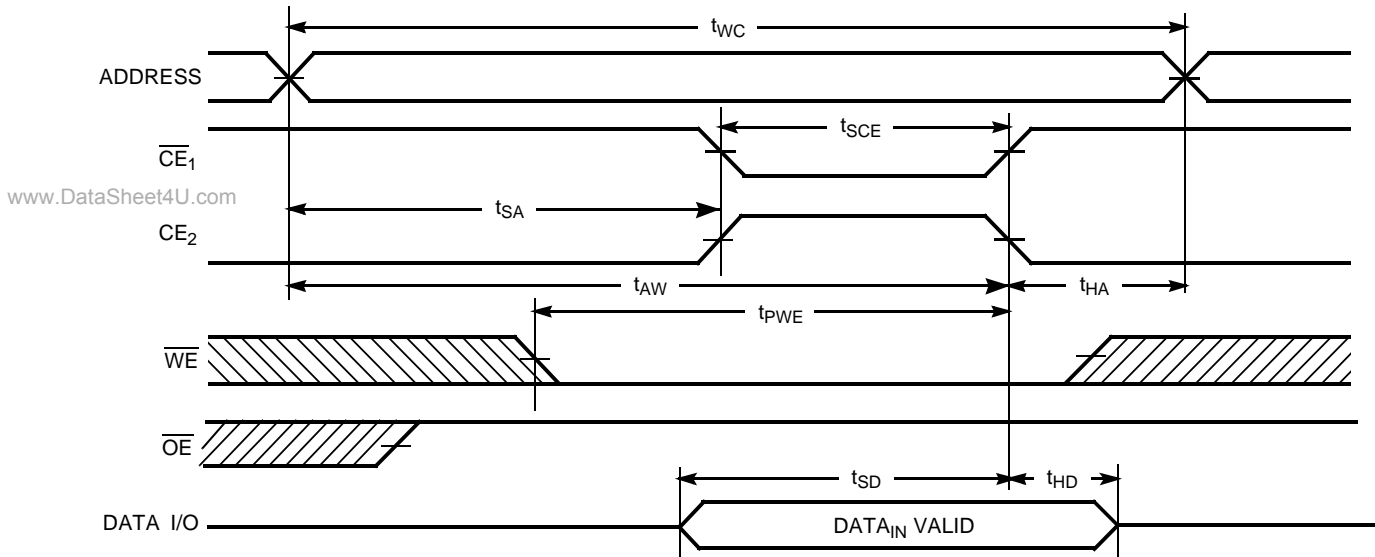

Notes:

- 12. Data I/O is high impedance if $\overline{OE} = V_{IH}$.
- 13. During this period, the I/Os are in output state and input signals should not be applied.
- 14. If \overline{CE}_1 goes HIGH or \overline{CE}_2 goes LOW simultaneously with \overline{WE} HIGH, the output remains in a high-impedance state.

Switching Waveforms (continued)

Write Cycle No. 3 (\overline{WE} Controlled, \overline{OE} LOW) ^[14]

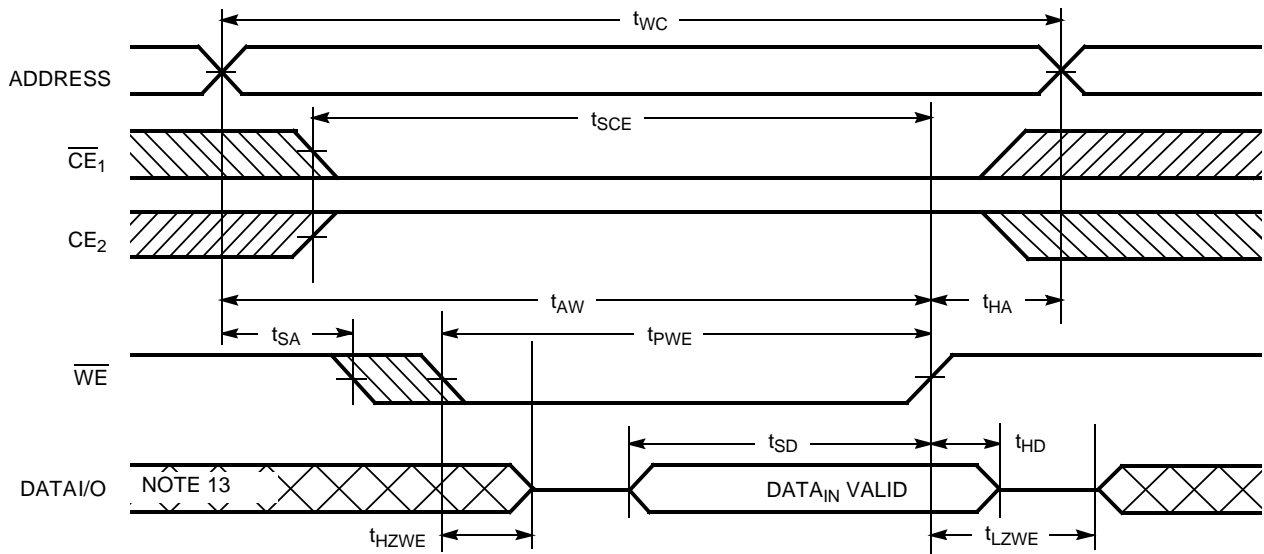



WCMA2008U1X

Truth Table

\overline{CE}_1	\overline{CE}_2	\overline{WE}	\overline{OE}	Inputs/Outputs	Mode	Power
H	X	X	X	High Z	Deselect/Power-Down	Standby (I_{SB})
X	L	X	X	High Z	Deselect/Power-Down	Standby (I_{SB})
L	H	H	L	Data Out	Read	Active (I_{CC})
L	H	L	X	Data In	Write	Active (I_{CC})
L	H	H	H	High Z	Output Disabled	Active (I_{CC})

Ordering Information

Speed (ns)	Ordering Code	Package Name	Package Type	Operating Range
70	WCMA2008U1X-FF70	FA36A	36-ball Fine Pitch BGA	Industrial

Package Diagrams

36-ball (7.0 mm x 7.0 mm x 1.2 mm) Fine Pitch BGA, FA36A

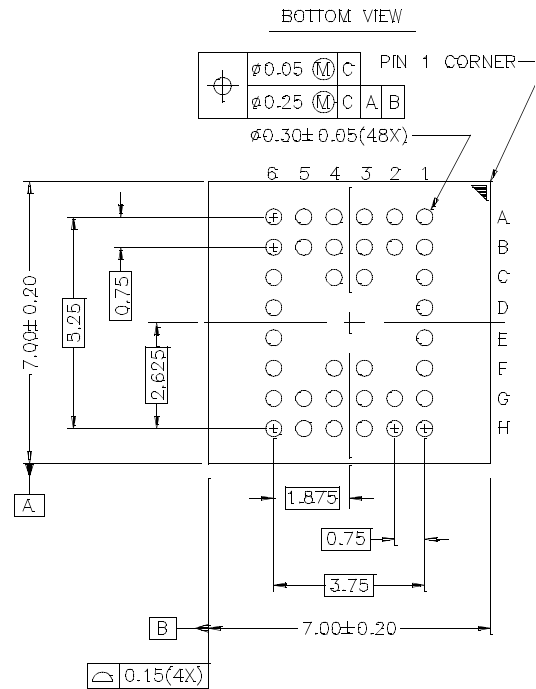
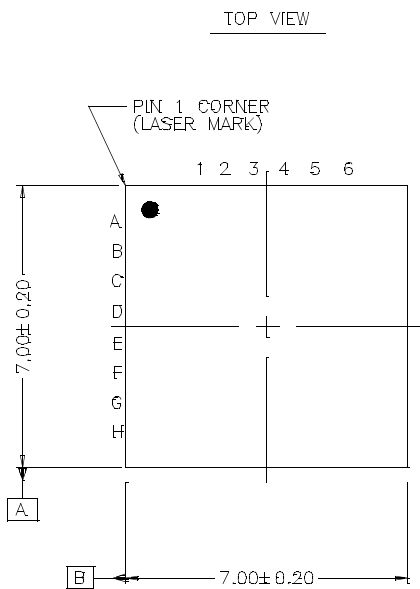

www.DataSheet4U.com

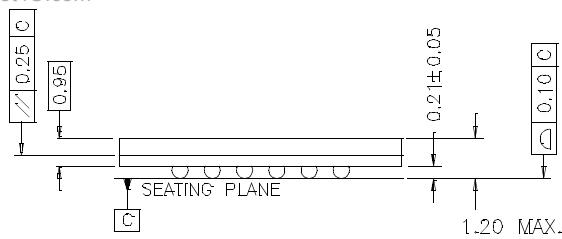



WCMA2008U1X

Document Title: WCMA2008U1X, 256K x 8 Static RAM					
REV.	Spec #	ECN #	Issue Date	Orig. of Change	Description of Change
**	38-14021	115240	3/18/2002	MGN	New Data Sheet