

Hall Effect Base Linear Current Sensor

Features:

- New spring structure with high measurement stability (increased by more than 2 times)
- 10.4 x 8 mm² split through hole design
- Output voltage proportional to AC and DC current
- Wide sensing current range 0~70 A at 5V volt
- High sensitivity 36 mV/A
- Wide operating voltage range 3.0~12V
- Low operating current 3 mA
- Isolation voltage 4000 V
- Ratiometric output from supply voltage
- 23 KHz Bandwidth
- Two bronze sticks for easy soldering on PCB

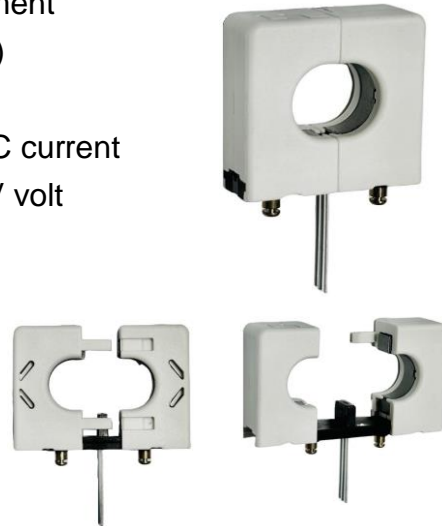

Functional Description:

The WCS7700 consists of a precise, low-temperature drift linear hall sensor IC and 10.4x8 mm² split through hole. Users can use system's own electric wire by pass it through this hole to measure passing current. **The unique spring structure of WCS7700 can improve the tightness on both sides of the iron core, making measurement more stable and reducing the influence of structural opening and closing tolerances.** This design allows system designers to monitor any current path without breaking or changing original system layout at all. Any current flowing through this hole will generate a magnetic field which is sensed by the integrated Hall IC and converted into a proportional voltage.

The Winson WCS7700 current sensor provides economical and precise solution for both DC and AC current sensing in industrial, commercial and communications systems.

The terminals of the conductive path are electrically isolated from the sensor leads. This allows the WCS7700 current sensor to be used in applications requiring electrical isolation without the use of opto-isolators or other costly isolation techniques and make system more competitive in cost.

Winson reserves the right to make changes to improve reliability or manufacturability.

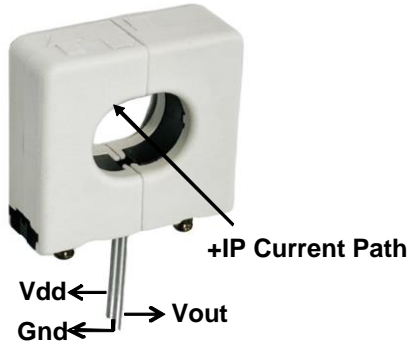

Vout vs. Primary Current

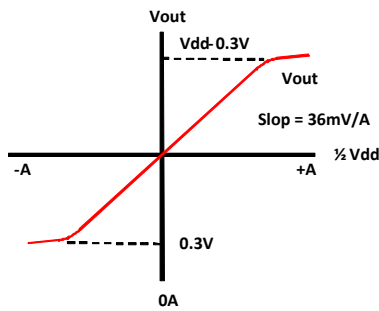

Absolute Maximum Range

Supply Voltage, Vdd	-----	14V
Pass Through Wire Channel	-----	10.4X8mm ²
Output Current Sink	-----	0.4mA
Output Current Source	-----	2mA
Basic Isolation Voltage	-----	4000V
Operating Temperature Range, Ta	-----	-20°C to +125°C
Storage Temperature Range, Ts	-----	-65°C to +150°C
Power Dissipation, Pd	-----	1W

Order Information

(Vdd = 5V)

Part No.	Sensitivity	Current range
WCS7700	36mV/A	DC: ± 0 ~ 70A
		AC: rms 50A

Function Block:

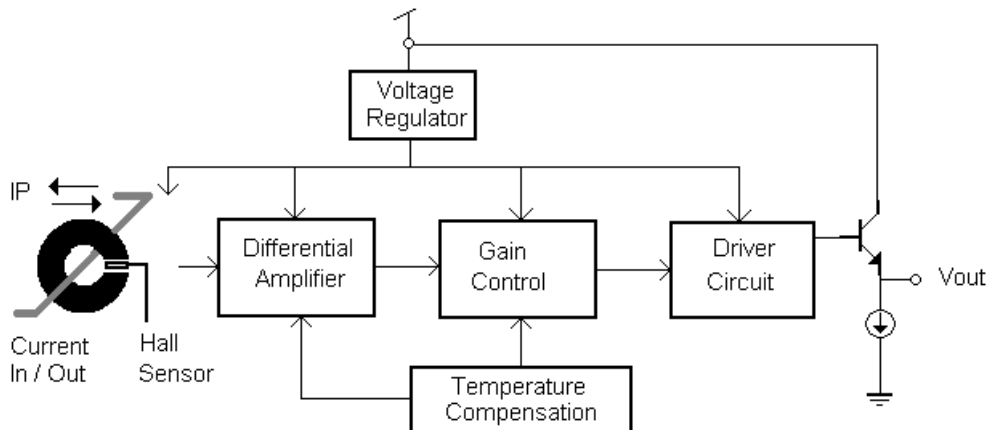

Winson reserves the right to make changes to improve reliability or manufacturability.

Electrical Characteristics:

(T=+25°C, V_{dd}=5.0V)

Characteristic	Symbol	Test Conditions	Min	Typ	Max	Units
Supply Voltage	V _{dd}	—	3.0	—	12	V
Supply Current	I _{supply}	IP = 0 A	—	3.5	6.0	mA
Zero Current Vout	V _{0G}	IP = 0 A	2.4	2.5	2.6	V
Conductor Through Hole	—	—	—	10.4x8	—	mm ²
Sensitivity	Sens	IP = ±10 A	30	36	42	mV/A
Bandwidth	BW	—	—	23	—	kHz
Measurable Current Range	MR	V _{dd} =5V (DC Mode)	—	±70	—	A
		V _{dd} =5V (AC RMS)	—	50	—	
Temperature Drift	ΔVout	IP = 0 A	—	±0.5	—	mV/°C
Output Noise	V _{Np-p}	IP = 0 A	—	7.5	—	mV
	V _{Np-p(0.01uF)}	IP = 0 A, C = 0.01 uF	—	1	—	

1. All output-voltage measurements are made with a voltmeter having an input impedance of at least 100kΩ

2. Do not apply any 'resistor load' on output pin, it will degrade IC's performance.

Characteristic Diagrams:

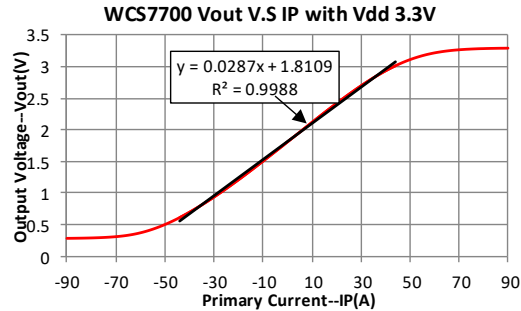
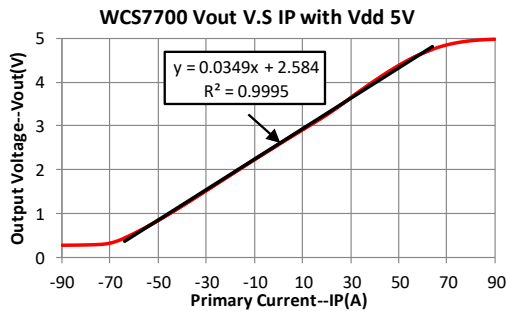
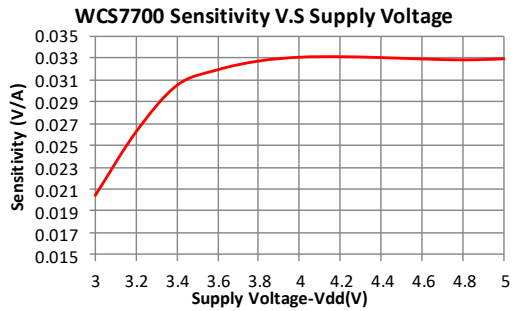
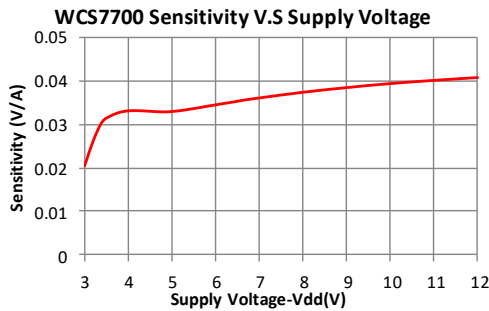

Winson reserves the right to make changes to improve reliability or manufacturability.

WCS7700 Sensitivity standardization of 30°C (5V) V.S Temperature

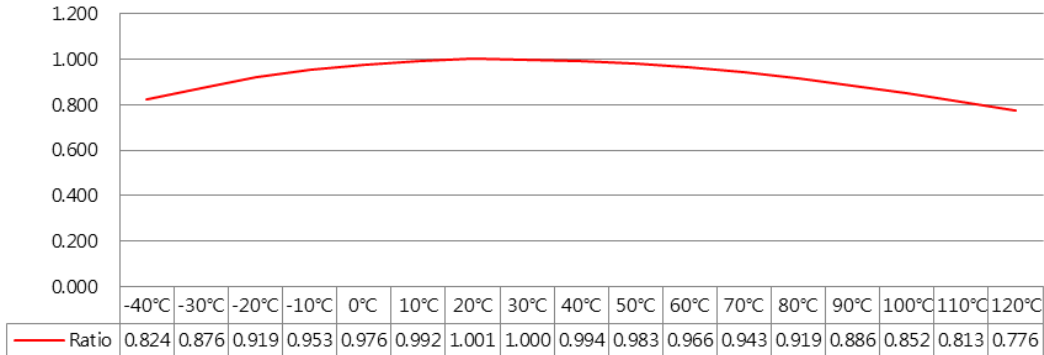

WCS7700 Sensitivity standardization of 30°C (3.3V) V.S Temperature

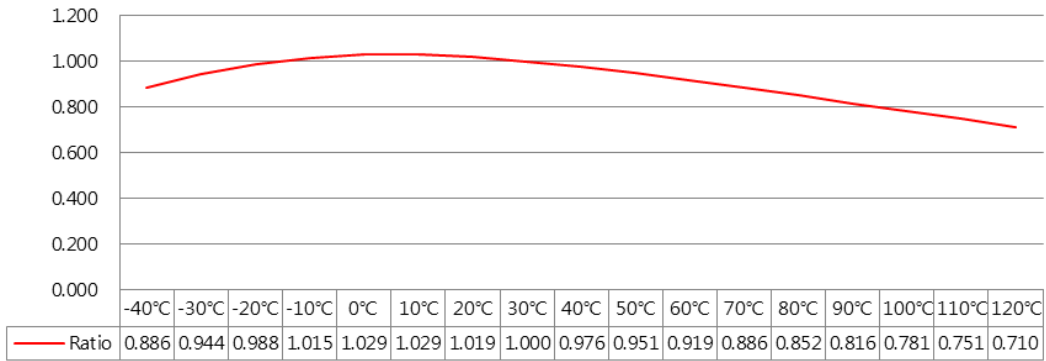

Winson reserves the right to make changes to improve reliability or manufacturability.

Application Circuit:

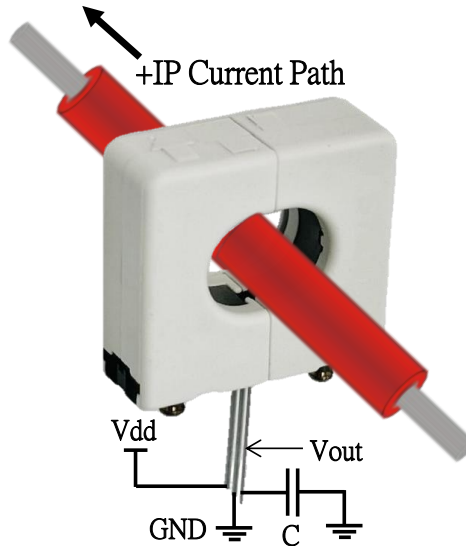

Capacitor C(0.01uF~0.1uF) is recommend to be connected between Vout and GND to reduce output noise.

Application Notice:

There is a linear variation of sensitivity along the y directions. Keep wire as fixed as possible to get steadiest reading.

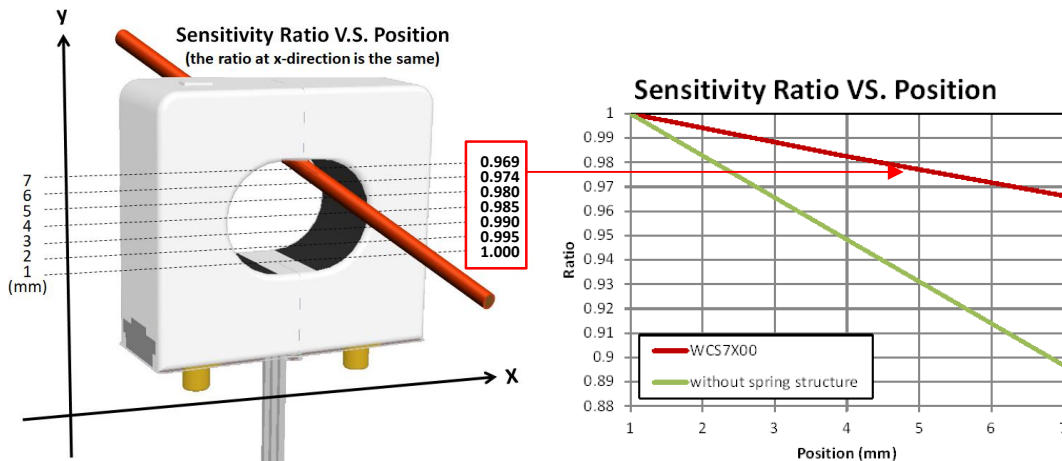

The unique spring structure of WCS7X00 can significantly reduce the impact of the vertical position of the current wire on the sensitivity.

WCS Application Note : please refer to Winson Website -> Products->

Application Note -> WCS Application Note :

<http://www.winson.com.tw/Product/83>

Winson reserves the right to make changes to improve reliability or manufacturability.

Package Information:

Unit : mm

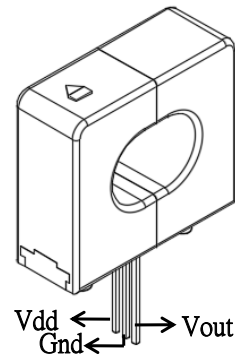
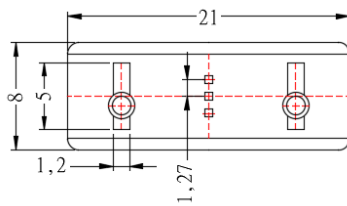
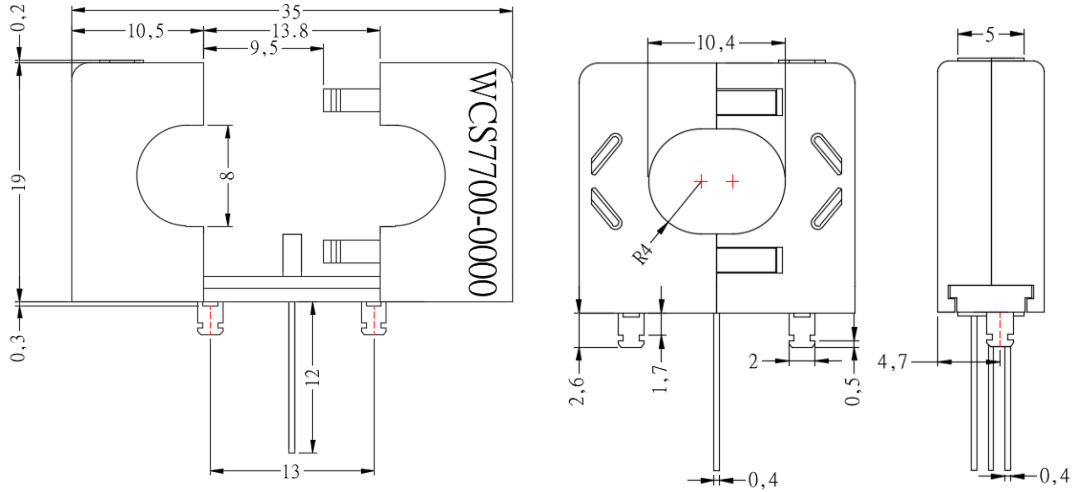

PCB Layout Reference View (Top View)

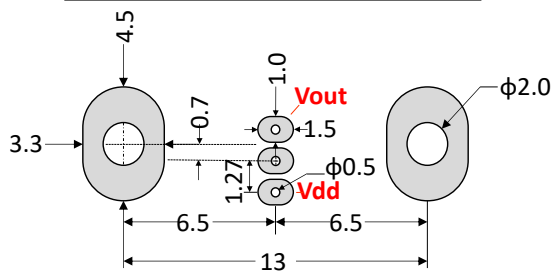

Winson reserves the right to make changes to improve reliability or manufacturability.