

# **WECX-D25501**

Intel D2550

User Manual

Rev.01, Nov. 2012

## Statement

All rights reserved. No part of this publication may be reproduced in any form or by any means, without prior written permission of the publisher.

All trademarks are the properties of the respective owners.

All product specifications are subject to change without prior notice

## Packing List

- WECX-D25501
- Driver CD (Include user's manual)

# Contents

Chapter 1 Product Information .....	錯誤! 尚未定義書籤。
1.1 Block Diagram.....	5
1.2 Features .....	6
1.3 PCB Layout.....	8
1.4 Jumper Setting .....	9
1.5 Connector Function List .....	13
1.6 Internal Connector Pin Define .....	14
Chapter 2 BIOS Setup.....	19
2.1 Main Menu .....	19
2.2 Advanced Menu .....	20
2.3 PCI Subsystem Setting .....	21
2.4 Advanced BIOS Feature Setup .....	22
2.5 CPU Configuration .....	23
2.6 SATA Configuration .....	24
2.7 USB Configuration .....	25
2.8 Super IO Configuration .....	27
2.9 Serial Port 0 Configuration .....	28
2.10 Serial Port 1 Configuration .....	29
2.11 Parallel Port Configuration.....	30
2.12 Pc Health Status.....	31
2.13 Serial Super IO Configuration .....	32
2.14 Serial Port Configuration .....	33
2.15 Chipset.....	35
2.16 Memory Information .....	36
2.17 Chipset Configuration.....	37
2.18 Intel IGD Configuration.....	38
2.19 PCI Express Root Ports Configuration .....	40
2.20 USB Mode.....	41
2.21 PCI Express Ports Configuration.....	43
2.22 Boot Configuration .....	45
2.23 Password Description .....	47
2.24 Save Changes and Exit.....	48
Chapter 3 Drivers Installation .....	49
3.1 Intel Chipset Device Software .....	49
3.2 Intel Graphic Media Accelerator Driver.....	52
3.3 LAN Driver.....	55

3.4 Audio Driver.....	57
Appendix-A Watchdog.....	58
Appendix-B GPIO.....	61

# Chapter 1 Product Information

This chapter introduces the product features, jumper and connector information.

## 1.1 Block Diagram

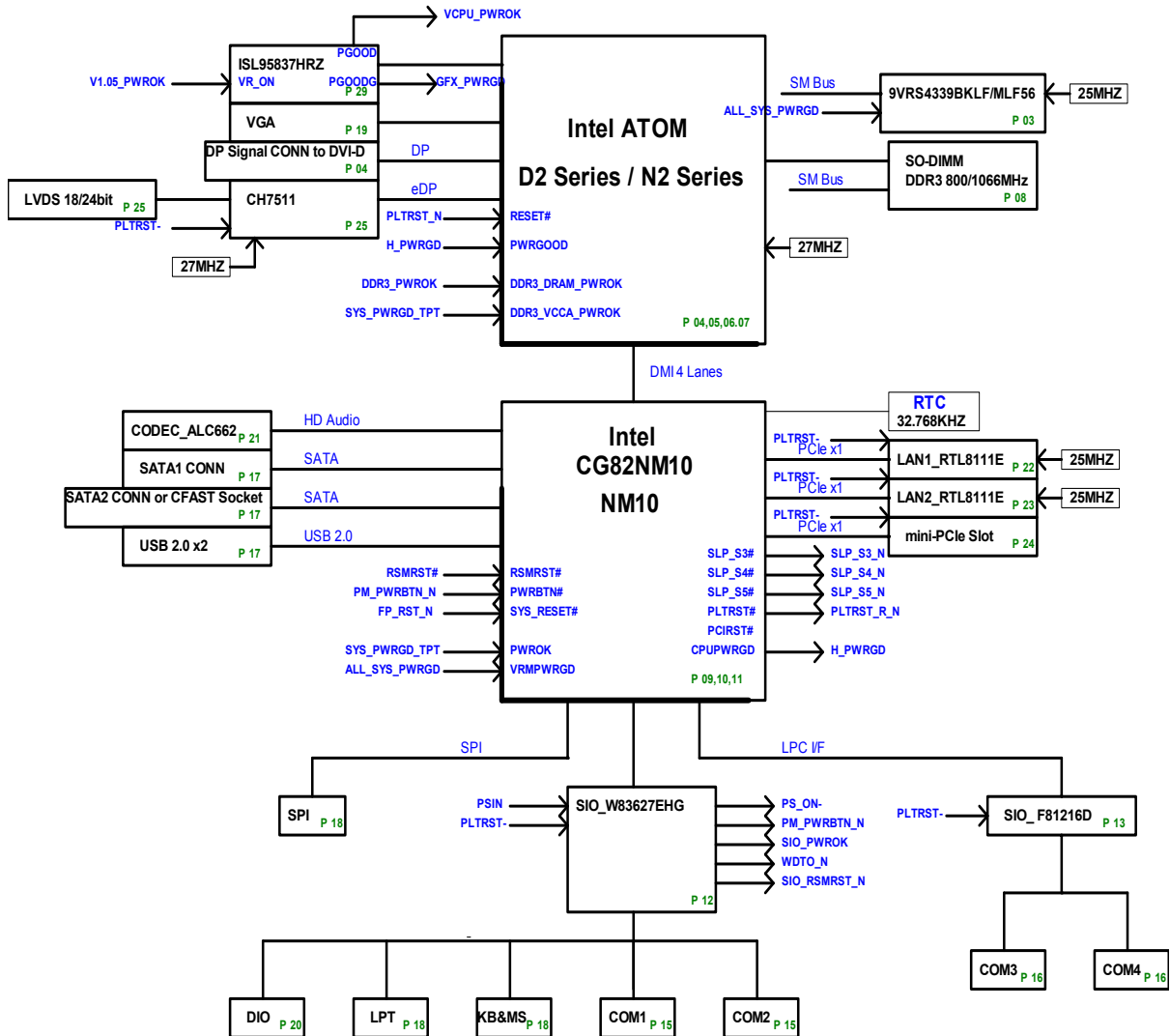

## 1.2 Features

<b>System Processor/ Chipsets</b>	Processor	Intel ATOM Processor D2550 processor on board
	Chipset	Intel D2550 + NM10
	BIOS	AMI
<b>Memory</b>	Technology	One 204-pin DDR3 1066 SO-DIMM SDRAM, upgradable to 4GB
<b>Display</b>	Chipset	Intel D2550 integrated
	VRAM	Share with System memory
	Resolution	Analog Display: Up to 2048 x 1536 (QXGA)
	LVDS	24bit, Dual channel
	LVDS Resolution	Digital LVDS: Up to 1920 x 1200
	Dual Display	CRT+LVDS, CRT+DP, LVDS+DP
<b>Ethernet</b>	Interface	Dual 10/100/1000 Mbps
	Controller	Realtek 8111E GbE
<b>Audio</b>	Interface	High Definition Audio
	Controller	Realtek ALC662 HD CODEC
<b>SATA</b>	Max. Data Transfer	300 MB/s
	Port	1
<b>Expansion Bus</b>	Mini-PCle	1
<b>Onboard Pin-Header</b>	LVDS	1
	USB 2.0	2
	COM	3
	Parallel	1
	DP	1
	Audio Header	1 (Mic.-In, Line-in, Line-out)
	C-Fast	1
	DIO <b>*Note1</b>	8-bit Digital I/O (4 In + 4 Out)
	PS/2	1 (K/B and Mouse)
<b>Rear I/O</b>	COM	1 x (RS232/422/485), support 5V & 12V by jumper selector
	VGA	1
	LAN	2 x RJ45
	USB 2.0	2

<b>Power</b>	Connector Type	4-pin DC-in power connector
	Mode	AT/ATX Mode support (by jumper selector)
<b>Watchdog Timer</b>	Interval	Programmable 1~255 sec./min.
	Output	System reset
<b>Environment</b> <b>*Note2</b>	Operating Temp.	0°C~ 60°C
	Storage Temp.	-20°C~ 80°C
	Relative Humidity	0%~ 95% (non-condensing)
<b>Form Factor</b>	Dimension (L*W)	146mm x 102mm

**\*Note:**

1. Digital I/O:

Input: 12V-tolerance & TTL inputs with ESD protection.

Output: Open-drain outputs with minimum **100mA** sinking capability.

2. Laboratory Stress Test Results:

Operating Temperature: 0°C ~ 60°C (0%~95% R.H., non-condensing)

Cold Boot Temperature: **-40°C**

# 1.3 PCB Layout

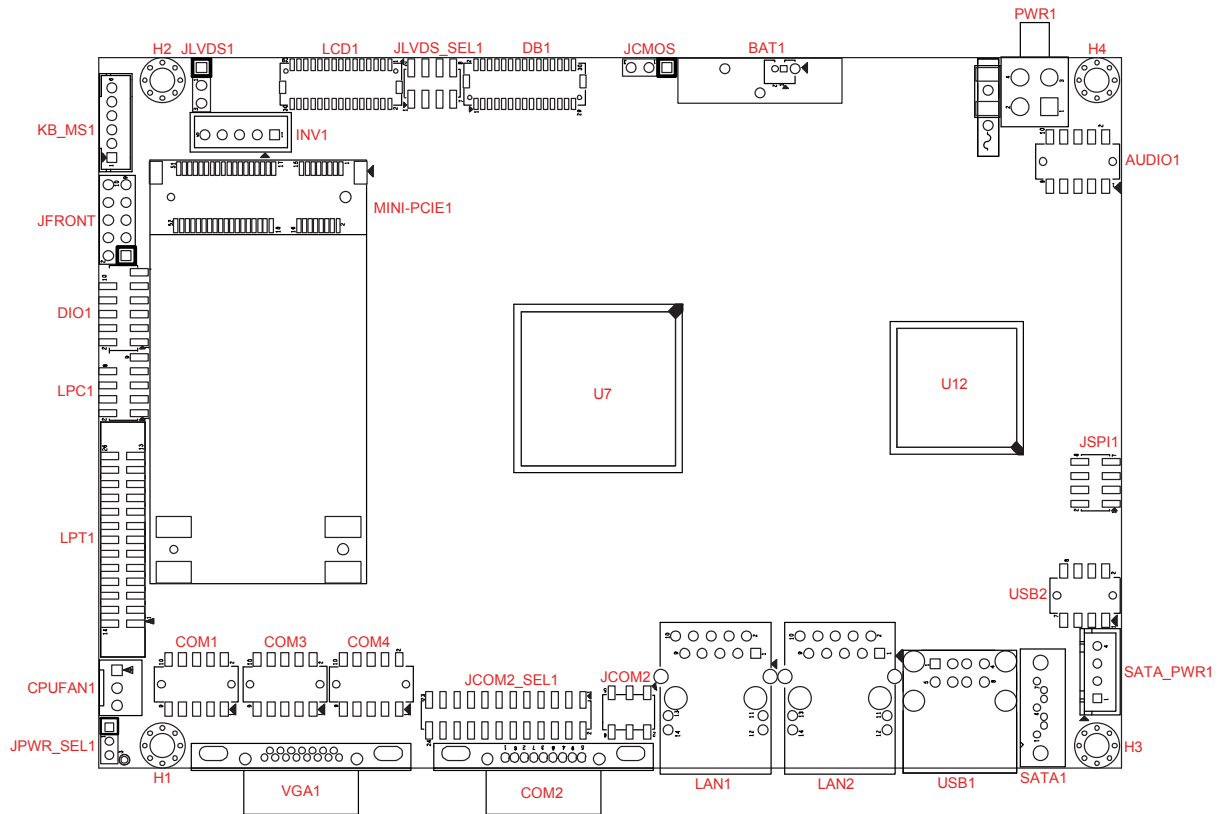



## 1.4 Jumper Setting

### JCMOS: CMOS Clear (2.54mm)

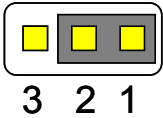
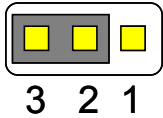
Pin No.	1-2	2-3
Function	Normal Operation (Default)	Clear CMOS Contents
Jumper Setting	 3 2 1	 3 2 1

### JCOM2: (5V/12V/RI) Select (2.54mm)

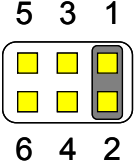
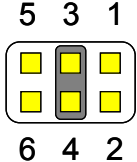
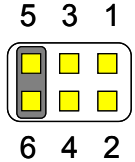
Pin No.	1-2	3-4	5-6
Function	+5V	Modem Ring In (Default)	+12V
Jumper Setting	 5 3 1 6 4 2	 5 3 1 6 4 2	 5 3 1 6 4 2

### JCOM2 SEL: COM2 (RS-232/RS-422/RS-485) Select (1/3) (2.0mm)

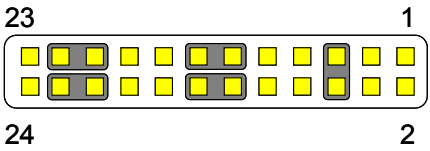
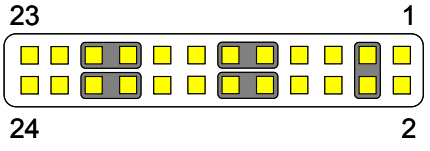
Pin No.	5-6, 11-13, 12-14, 19-21, 20-22	3-4, 9-11, 10-12, 17-19, 18-20
Function	RS-232 (Default)	RS-422
Jumper Setting	 23 1 24 2	 23 1 24 2

### JCOM2 SEL: COM2 (RS-232/RS-422/RS-485) Select (2/3) (2.0mm)

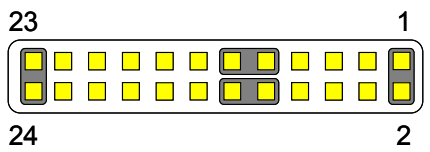
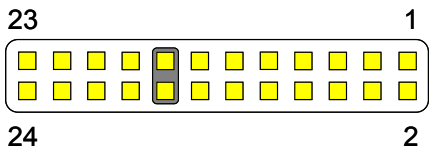
Pin No.	1-2, 9-11, 10-12, 23-24	15-16
Function	RS-485	RS-422 RX 100Ω Termination
Jumper Setting	 23 1 24 2	 23 1 24 2

**JCOM2 SEL1: COM2 (RS-232/RS-422/RS-485) Select (3/3) (2.0mm)**

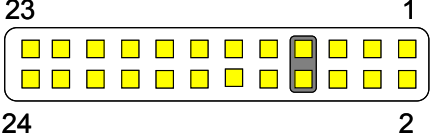
Pin No.	7-8
Function	RS-422 TXD Pair 100Ω (Not recommended)/ RS-485 Data Pair Termination
Jumper Setting	

**JLVDS1: LCD Power (+3.3V/+5V) Select**

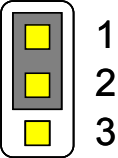
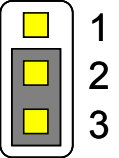
Pin No.	1-2	2-3
Function	LCD Power +3.3V (Default)	LCD Power +5V
Jumper Setting		

### JLVDS SEL1: LVDS Panel Type Select

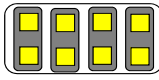
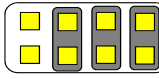
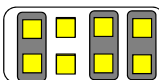
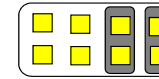
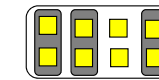
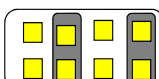
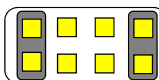
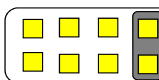
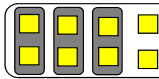
Pin No.	Jumper Setting	LVDS Panel Type
1-2, 3-4, 5-6, 7-8 (Default)	<p>2 4 6 8</p>  <p>1 3 5 7</p>	800*600/18bit Single Channel
3-4, 5-6, 7-8	<p>2 4 6 8</p>  <p>1 3 5 7</p>	1024*768/18bit Single Channel
1-2, 5-6, 7-8	<p>2 4 6 8</p>  <p>1 3 5 7</p>	1024*768/24bit Single Channel
5-6, 7-8	<p>2 4 6 8</p>  <p>1 3 5 7</p>	1280*768/18bit Single Channel
1-2, 3-4, 7-8	<p>2 4 6 8</p>  <p>1 3 5 7</p>	1280*800/18bit Single Channel
3-4, 7-8	<p>2 4 6 8</p>  <p>1 3 5 7</p>	1280*960/18bit Single Channel
1-2, 7-8	<p>2 4 6 8</p>  <p>1 3 5 7</p>	1280*1024/24bit Dual Channel
7-8	<p>2 4 6 8</p>  <p>1 3 5 7</p>	1366*768/18bit Single Channel
1-2, 3-4, 5-6	<p>2 4 6 8</p>  <p>1 3 5 7</p>	1366*768/24bit Single Channel

3-4, 5-6		1400*900/24bit Dual Channel
1-2, 5-6		1400*1050/24bit Dual Channel
5-6		1600*900/24bit Dual Channel
1-2, 3-4		1680*1050/24bit Dual Channel
3-4		1600*1200/24bit Dual Channel
1-2		1920*1080/24bit Dual Channel
NC		1920*1200/24bit Dual Channel

### **JPWR SEL1: AT/ATX Mode Select**

Pin No.	1-2	2-3
Function	AT Mode	ATX Mode (Default)
Jumper Setting		

## 1.5 Connector Function List

Connector	Function	Note
AUDIO1	Audio Amplifier Output with Wafer connector	
COM1, 3, 4	Serial Port with Box-header	
COM2	Serial Port with DSUB-9P connector	
CPUFAN1	CPUFAN 3-pin connector	
DIO1	Digital I/O with Pin-header	
INV1	Inverter with Box-header	
JFRONT	Front Panel with Pin-header	
KB_MS1	Keyboard and mouse connector	
LAN1, 2	LAN connector	
LCD1	LVDS Panel Signal with Box-header	
LPC1	Debug Port with Pin-header	
LPT1	Parallel Port with Box-header	
MINI-PCIE1	Mini PCI Express connector	
PWR1	ATX 2x2 connector	
SATA1	SATA connector	
SATA_PWR1,	SATA Power with Box-header	
USB1	USB0/1 Port connector	
USB2	USB2/3 connector with Pin-header	
VGA1	VGA connector	

## 1.6 Internal Connector Pin Define

### **AUDIO: Audio Amplifier Output with Wafer connector (2.0mm)**

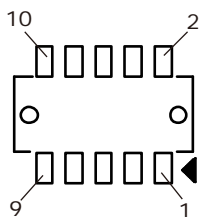

Pin No.	Signal	Pin No.	Signal
1	Line-In Right	2	Line-In Left
3	Line-In Jack Detect	4	MIC Jack Detect
5	MIC-In Right	6	MIC-In Left
7	Line-Out Jack Detect	8	Audio Ground
9	Line-Out Right	10	Line-Out Left

### **COM1, 3, 4: Serial Port with Box-header (2.0mm)**

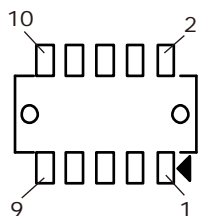

Pin No.	Signal	Pin No.	Signal
1	DCD	2	DSR
3	RXD	4	RTS
5	TXD	6	CTS
7	DTR	8,10	RI/+5V/+12V
9	Ground		

### **COM2: RS 232 Serial Port with DSUB-9P connector (1/3)**

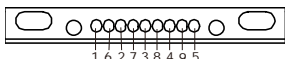

Pin No.	Signal	Pin No.	Signal
1	DCD	2	RXD
3	TXD	4	DTR
5	Ground	6	DSR
7	RTS	8	CTS
9	RI/+5V/+12V		

### **COM2: RS 422 Serial Port with DSUB-9P connector (2/3)**

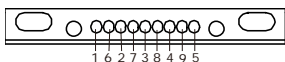

Pin No.	Signal	Pin No.	Signal
1	DATA TX-	2	DATA TX+
3	DATA RX+	4	DATA RX-
5	NC	6	NC
7	NC	8	NC
9	NC		

**COM2: RS 485 Serial Port with DSUB-9P connector (3/3)**

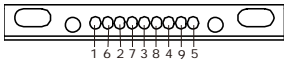

Pin No.	Signal	Pin No.	Signal
1	DATA-	2	DATA+
3	NC	4	NC
5	NC	6	NC
7	NC	8	NC
9	NC		

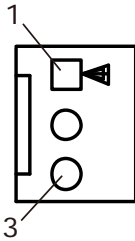

**CPUFAN: 3Pin FAN connector**

Pin No.	Signal
1	Ground
2	Fan Power (+12V)
3	Speed Sense

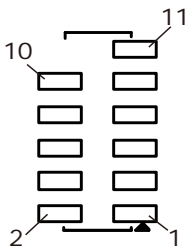

**DIO: Digital I/O with Pin-header (2.00mm)**

Pin No.	Signal	Pin No.	Signal
1	DIO-Out0	2	DIO-In0
3	DIO-Out1	4	DIO-In1
5	DIO-Out2	6	DIO-In2
7	DIO-Out3	8	DIO-In3
9	+12V	10	+5V
11	Ground		

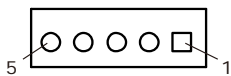

**INV1: Inverter with Box-header (2.50mm)**

Pin No.	Signal
1	+12V
2	+12V
3	Ground
4	Inverter Brightness control
5	Inverter Enable

**JFRONT: Front Panel Connector with Pin-header (2.54mm)**

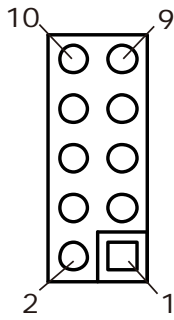

Pin No.	Signal	Pin No.	Signal
1	Power LED + (+5V, 470Ω)	2	Power LED – (Ground)
3	HDD LED + (470Ω)	4	HDD LED -
5	Suspend LED + (+V5S, 470Ω)	6	Suspend LED -
7	Reset Switch +	8	Reset Switch – (Ground)
9	Power Switch +	10	Power Switch – (Ground)

**KB MS1: Keyboard and mouse connector (2.00mm)**

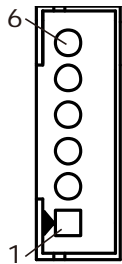

Pin No.	Signal
1	PS2 Power (+5V)
2	PS2 Mouse Data
3	PS2 Mouse Clock
4	PS2 Keyboard Data
5	PS2 Keyboard Clock
6	PS2 Ground

**LCD1: LVDS Panel Signal with Box-header (1.0mm)**

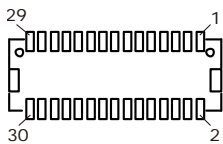

Pin No.	Signal	Pin No.	Signal
1	Ground	2	Ground
3	LA_DC3+	4	LA_DC3-
5	LA_CLK+	6	LA_CLK-
7	LA_DC2+	8	LA_DC2-
9	LA_DC1+	10	LA_DC1-
11	LA_DC0+	12	LA_DC0-
13	Ground	14	Ground
15	LB_DC7P	16	LB_DC7N
17	LB_CLK2P	18	LB_CLK2N
19	LB_DC6P	20	LB_DC6N
21	LB_DC5P	22	BL_DC5N
23	LB_DC4P	24	LB_DC4N



25	Ground	26	Ground
27	LVDS Power	28	LVDS Power
29	LVDS Power	30	LVDS Power

Note1: LVDS Power = +5V or +3.3V (Default)

#### **LPC1: Debug Port with Pin-header (2.0mm)**

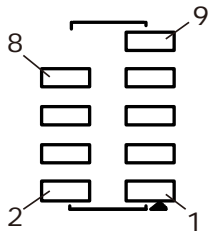

Pin No.	Signal	Pin No.	Signal
1	LAD0	2	LPC Reset#
3	LAD1	4	LFRAME#
5	LAD2	6	+3.3V
7	LAD3	8	Ground
9	LPC33MHz	10	NC

#### **LPT1: Parallel Port with Box-header (2.0mm)**

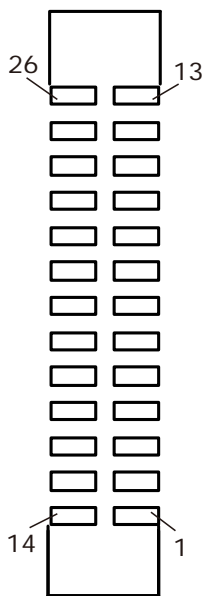

Pin No.	Signal	Pin No.	Signal
1	Strobe#	14	Auto Form Feed#
2	Data 0	15	Error#
3	Data 1	16	Initialization#
4	Data 2	17	Printer Select IN#
5	Data 3	18	Ground
6	Data 4	19	Ground
7	Data 5	20	Ground
8	Data 6	21	Ground
9	Data 7	22	Ground
10	Acknowledge#	23	Ground
11	Busy	24	Ground
12	Paper Empty	25	Ground
13	Printer Select	26	Ground

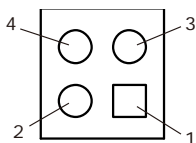

#### **PWR1: ATX 2x2 +12V Input (4.20mm)**

Pin No.	Signal	Pin No.	Signal
1	Ground	2	Ground
3	+12V	4	+12V

**SATA1: SATA Connector (2.50mm)**

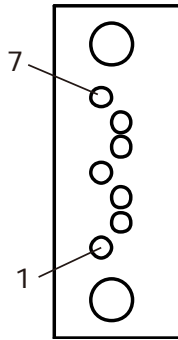

Pin No.	Signal
1	Ground
2	TX+
3	TX-
4	Ground 1
5	RX-
6	RX+
7	Ground 2

**SATA PWR1: SATA Power with Box-header (2.50mm)**

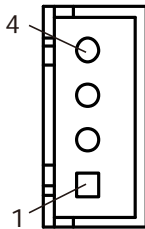

Pin No.	Signal
1	+5V
2	Ground
3	Ground
4	+12V

**USB2/3: USB connector with Pin header (2.0mm)**

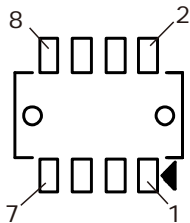

Pin No.	Signal	Pin No.	Signal
1	USB Power (+5V)	2	USB Power (+5V)
3	USB DATA-	4	USB DATA-
5	USB DATA+	6	USB DATA+
7	Ground	8	Ground

## Chapter 2 BIOS Setup

This chapter introduces BIOS setup information.

Power on or reboot the system board, when screen appears message as “Press DEL to enter SETUP.” Press <DEL> to run BIOS SETUP Utility.

Note: The BIOS configuration for reference only, it may subject to change without prior notice.

### 2.1 Main Menu

Aptio Setup Utility - Copyright (C) 2011 American Megatrends, Inc.

Main Advanced Chipset Boot Security Save & Exit

BIOS Information		Choose the system default language
BIOS Vendor	American Megatrends	
Core Version	4.6.5.1	
Compliance	UEFI 2.3; PI 1.2	
Project Version	1APJK 0.14	
Model Name	WECX-D25501	
BIOS Version	RA05	
Build Date and Time	08/24/2012 22:47:05	
System Language	[English]	→← : Select Screen ↑↓ : Select Item Enter : Select +/- : Change Opt . F1: General Help F2: Previous Values F3: Optimized Defaults F4: Save & Exit ESC: Exit
System Date	[Mon 11/12/2012]	
System Time	[14:47:18]	
Access Level1	Administrator	

Version 2.14.1219. Copyright (C) 2011 American Megatrends, INC.

**Date**

Set system date.

**Time**

Set system time.

## 2.2 Advanced Menu

This section allows you to configure CPU and other system devices for basic operation through the following sub-menus.

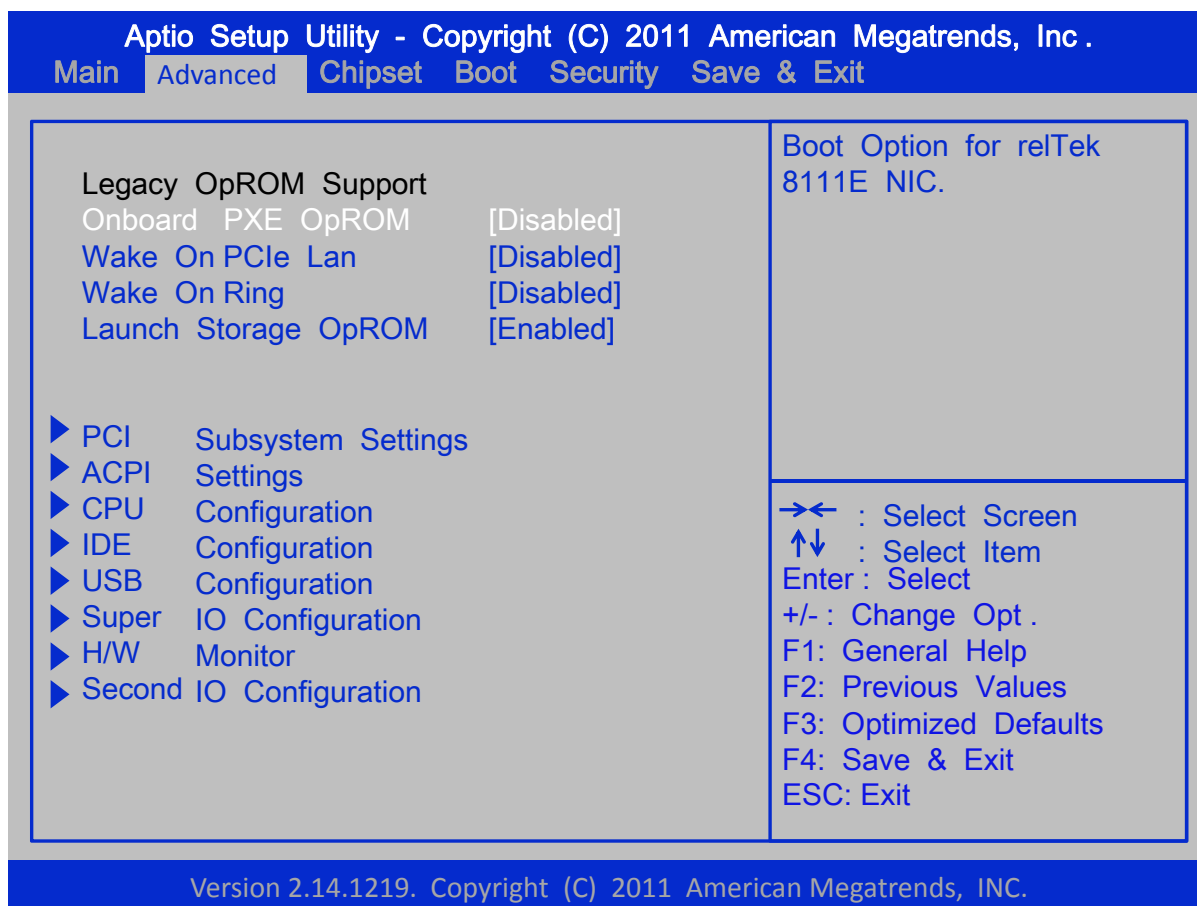

**Onboard PXE OpROM**

Choices: Disabled, Enabled.

**Wake On PCIe Lan**

Choices: Disabled, Enabled.

**Wake On Ring**

Choices: Disabled, Enabled.

**Launch Storage OpROM**

Enabled: Use this setting to specify that legacy PCI option ROMs for PCI storage devices are to be loaded and executed.

## 2.3 PCI Subsystem Setting

Aptio Setup Utility - Copyright (C) 2011 American Megatrends, Inc .	
Advanced	
PCI Bus Driver Versio V 2.05.01  PCI Option ROM Handling PCI ROM Priority [EFI Compatible ROM]	In case of multiple Option ROMs (Legacy and EFI Compatible) , specifies what PCI Option ROM to launch.
PCI Common Settings PCI Latency Timer [32 PCI Bus Clocks] VGA Palette Snoop [Disabled]	
→← : Select Screen ↑↓ : Select Item Enter : Select +/- : Change Opt . F1: General Help F2: Previous Values F3: Optimized Defaults F4: Save & Exit ESC: Exit	
Version 2.14.1219. Copyright (C) 2011 American Megatrends, INC.	

**PCI ROM Priority**

In case of multiple optional ROMs (Legacy and EFI Compatible), specifies what PCI option ROM to launch.

**PCI Latency Timer**

Choices: 32 PCI, 64 PCI, 96 PCI, 128 PCI, 160 PCI, 192 PCI, 224 PCI, 248 PCI Bus Clocks.

**VGA Palette Snoop**

Enable or Disable VGA palette registers snooping.

## 2.4 Advanced BIOS Feature Setup

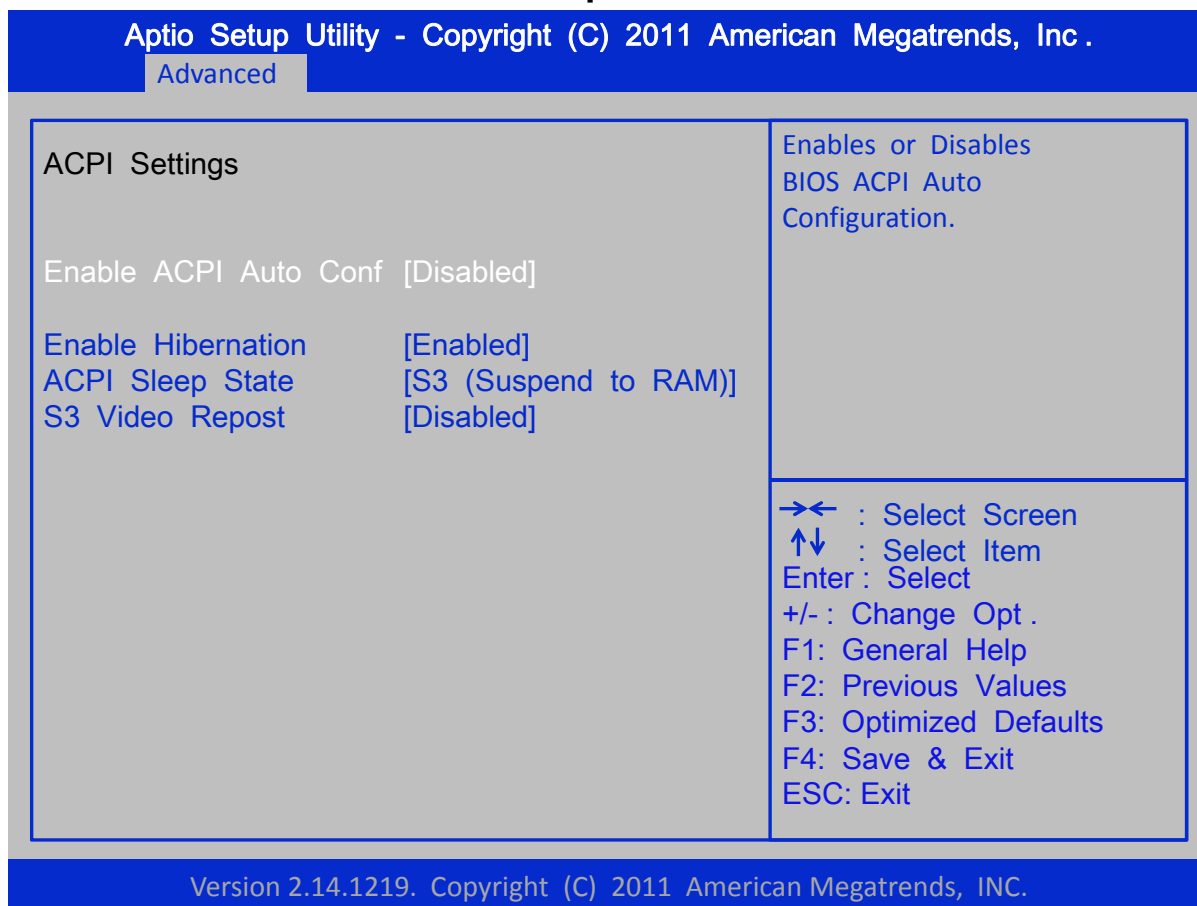

**Enable ACPI Auto Conf**

Choices: Disabled, Enabled.

**Enable Hibernation**

Choices: Disabled, Enabled.

**ACPI Sleep State**

Select the highest ACPI sleep state the system will enter, when SUSPEND button is pressed.

**S3 Video Repost**

Choices: Disabled, Enabled.

## 2.5 CPU Configuration

**Aptio Setup Utility - Copyright (C) 2009 American Megatrends, Inc.**

Advanced

<p>CPU Configuration</p> <p>Processor Type            Intel(R) Atom(TM) CPU EMT64                      Not Supported</p> <p>Processor Speed            1865 MHZ</p> <p>System Bus Speed          533 MHZ</p> <p>Ratio Status                14</p> <p>Actual Ratio                14</p> <p>System BUS Speed          533 MHZ</p> <p>Processor Stepping        30661</p> <p>Microcode Revision        265</p> <p>L1 Cache RAM              2x56 k</p> <p>L2 Cache RAM              2x512 k</p> <p>Processor Core             Dual</p> <p>Hyper-Threading          Supported</p> <p>Hyper-Threading          [Enabled]</p> <p>Execute Disable Bit        [Enabled]</p> <p>Limit CPUID Maximum      [Disabled]</p>	<p>Enabled for Windows XP and Linux (OS optimized for Hyper-Threading Technology) and Disabled for other OS (OS not optimized for Hyper-Threading Technology).</p> <p>→← : Select Screen          ↑↓ : Select Item          Enter : Select          +/- : Change Opt .          F1: General Help          F2: Previous Values          F3: Optimized Defaults          F4: Save &amp; Exit          ESC: Exit</p>
---	--

Version 2.14.1219. Copyright (C) 2011 American Megatrends, INC.

**Hyper-Threading**

Choices: Disabled, Enabled.

**Execute Disabled Bit**

Choices: Disabled, Enabled.

**Limit CPUID Maximum**

Disabled for Windows XP

Choices: Disabled, Enabled.

## 2.6 SATA Configuration

Aptio Setup Utility - Copyright (C) 2011 American Megatrends, Inc.		
Advanced		
SATA Port0	Not Present	SATA Ports (0-3) Device Names if Present and Enabled.
SATA Port1	Not Present	
SATA Controller(s)	[Enabled]	
Configure SATA as	[IDE]	
Misc Configuration for hard disk		
		→← : Select Screen ↑↓ : Select Item Enter : Select +/- : Change Opt . F1: General Help F2: Previous Values F3: Optimized Defaults F4: Save & Exit ESC: Exit

Version 2.14.1219. Copyright (C) 2011 American Megatrends, INC.

**Serial-ATA Controller(s)**

Choices: Disabled, Enabled.

**Configure SATA as**

Choices: IDE/AHCI



## 2.7 USB Configuration

Aptio Setup Utility - Copyright (C) 2009 American Megatrends, Inc.	
Advanced	
USB Configuration USB Devices 1 Drive, 1 Keyboard  Legacy USB Support                    [Enabled] EHCI Hand-off                            [Disabled]  USB hardware delays a USB transfer time-out                [20 sec] Device reset time-out                 [20 sec] Device power-up delay                 [Auto]  Mass Storage Devices: USB FLASH DRIVE PMAP               [Auto]	Enables Legacy USB support. AUTO option disables legacy support if no USB devices are connect. DISABLE option will keep USB devices available only for EFI applications.  →← : Select Screen ↑↓ : Select Item Enter : Select +/- : Change Opt . F1: General Help F2: Previous Values F3: Optimized Defaults F4: Save & Exit ESC: Exit
Version 2.14.1219. Copyright (C) 2011 American Megatrends, INC.	

### Legacy USB Support

Set [Enabled] if you need to use any USB 1.1/2.0 devices in the operating system that does not support or have any USB 1.1/2.0 drivers installed. Such as DOS and SCO Unix.

### EHCI Hand-off

This is a workaround for OSs without EHCI hand-off support. The EHCI ownership change should be claimed by EHCI driver.

### USB transfer time-out

Choices: 1, 5, 10, 20 sec.

### Device Reset time-out

USB mass storage device starts unit command timeout.  
 Choices: 10, 20, 30, 40 sec.

**Device power-up delay**

This setting determines the maximum time for USB device will take before reporting to the controller.

**USB Flash Drive PMAP**

This items shows when user inserts USB drive.

## 2.8 Super IO Configuration

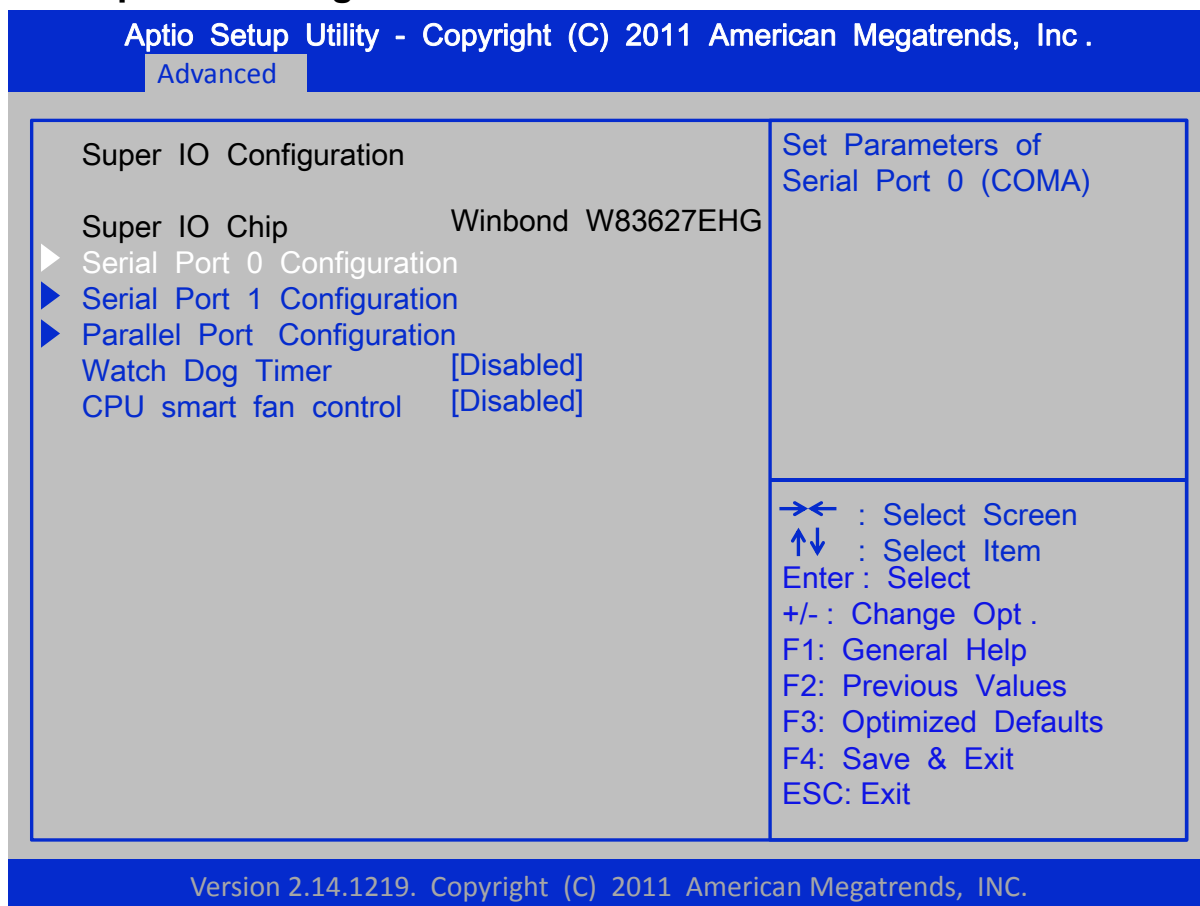

### Watch Dog Timer

This option will determine watch dog timer.

### CPU smart fan control

This option allows user to enable/disable the control of CPU fan speed by changing the fan voltage.

## 2.9 Serial Port 0 Configuration

Aptio Setup Utility - Copyright (C) 2011 American Megatrends, Inc .

Advanced

Serial Port 0 Configuration		Enable or Disable Serial Port (COM)
Serial Port	[Enabled]	
Device Settings	IO=3F8h; IRQ=4;	
Change Settings	[IO=3F8h; IRQ=4;]	
		→← : Select Screen ↑↓ : Select Item Enter : Select +/- : Change Opt . F1: General Help F2: Previous Values F3: Optimized Defaults F4: Save & Exit ESC: Exit

Version 2.14.1219. Copyright (C) 2011 American Megatrends, INC.

### Serial Port

Use this option to enable or disable the serial port.

### Device Settings

Use this option to show the serial port IO port address and interrupt address.

### Change Settings

Use this option to change the serial port IO port address and interrupt address.

## 2.10 Serial Port 1 Configuration

Aptio Setup Utility - Copyright (C) 2011 American Megatrends, Inc .

Advanced

Serial Port 1 Configuration		Enable or Disable Serial Port (COM)
Serial Port Device Settings	[Enabled] IO=2F8h; IRQ=3;	
Change Settings	[IO=2F8h; IRQ=3;]	
		→← : Select Screen ↑↓ : Select Item Enter : Select +/- : Change Opt . F1: General Help F2: Previous Values F3: Optimized Defaults F4: Save & Exit ESC: Exit

Version 2.14.1219. Copyright (C) 2011 American Megatrends, INC.

### Serial Port

Use this option to enable or disable the serial port.

### Device Settings

Use this option to change the device address and interrupt address.

### Change Settings

Use this option to change the serial port IO port address and interrupt address.

## 2.11 Parallel Port Configuration

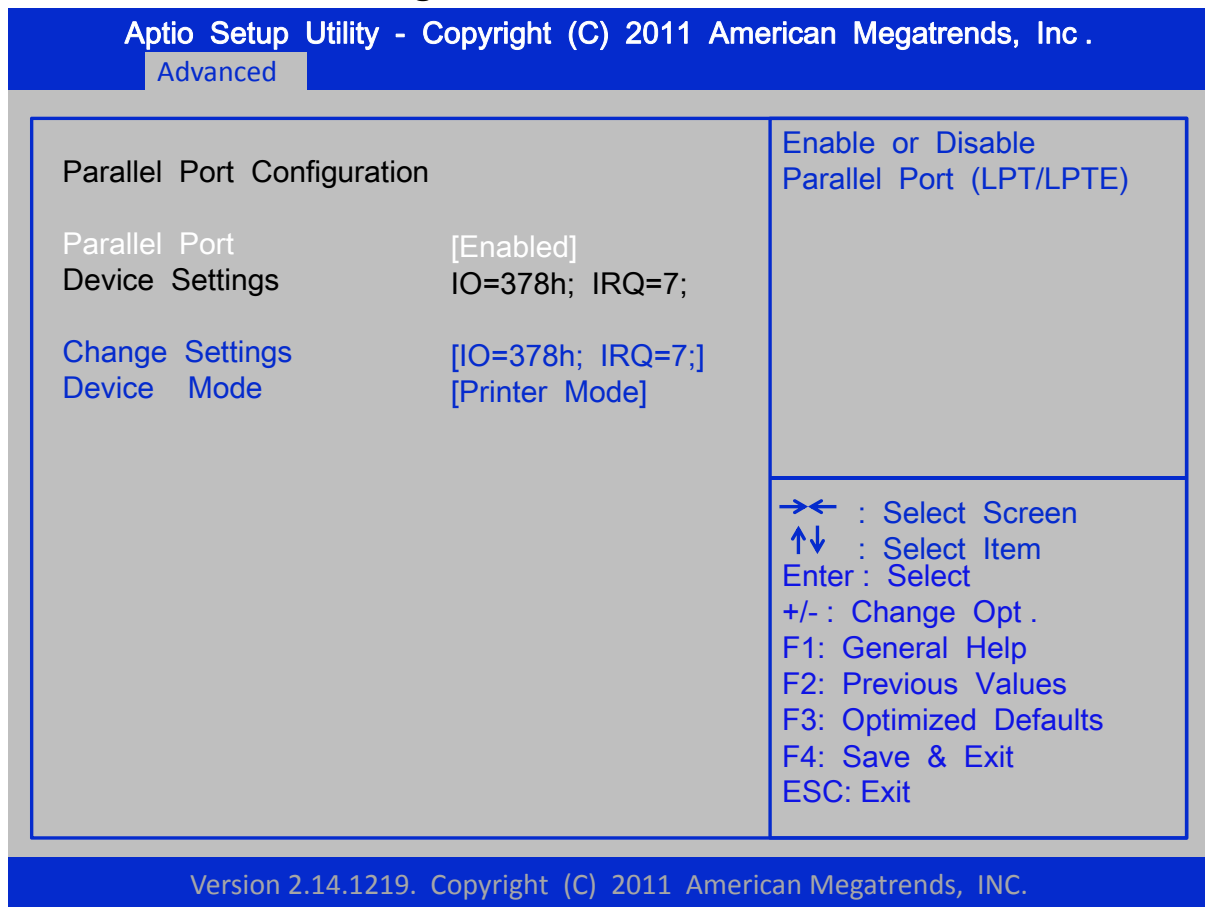

### **Parallel Port**

Use this option to enable or disable the parallel port.

### **Change Settings**

Use this option to change the serial port IO port address and interrupt address.

### **Device Mode**

Printer mode.

## 2.12 Pc Health Status

Aptio Setup Utility - Copyright (C) 2011 American Megatrends, Inc .

Advanced

Pc Health Status	
SYSTEM Temperature	: +32 C
CPU Temperature	: +34 C
CPU FAN Speed	: 7929 RPM
CPUVCORE	: +1.22 V
+12 V	: +11.88 V
+1.5 V	: +1.54 V
+5 V	: +5.02 V
+3.3 V	: +3.32 V
VBAT (V)	: +5.99 V
3.3VSB (V)	: +3.32 V

→← : Select Screen  
↑↓ : Select Item  
Enter : Select  
+/- : Change Opt .  
F1: General Help  
F2: Previous Values  
F3: Optimized Defaults  
F4: Save & Exit  
ESC: Exit

Version 2.14.1219. Copyright (C) 2011 American Megatrends, INC.

## 2.13 Serial Super IO Configuration

**Aptio Setup Utility - Copyright (C) 2011 American Megatrends, Inc.**

Advanced

Second IO Configuration	Set Parameters of Serial Port 1 (COMC)
Second IO Fintek F81216	
▶ Serial Port 1 Configuration	
▶ Serial Port 2 Configuration	

→← : Select Screen  
↑↓ : Select Item  
Enter : Select  
+/- : Change Opt .  
F1: General Help  
F2: Previous Values  
F3: Optimized Defaults  
F4: Save & Exit  
ESC: Exit

Version 2.14.1219. Copyright (C) 2011 American Megatrends, INC.

**Serial Port 1 Configuration**

**Serial Port 2 Configuration**



## 2.14 Serial Port Configuration

Aptio Setup Utility - Copyright (C) 2011 American Megatrends, Inc .

Advanced

Serial Port 1 Configuration		Enable or Disable Serial Port (COM)
Serial Port	[Enabled]	
Device Settings	Reset Required	
Change Settings	[IO=3E8h; IRQ=5;]	

→← : Select Screen  
↑↓ : Select Item  
Enter : Select  
+/- : Change Opt .  
F1: General Help  
F2: Previous Values  
F3: Optimized Defaults  
F4: Save & Exit  
ESC: Exit

Version 2.14.1219. Copyright (C) 2011 American Megatrends, INC.

### Serial Port

Use this option to enable or disable the serial port.

### Change Settings

Use this option to change the serial port IO port address and interrupt address.

## □ Serial Port 2 Configuration

The screenshot shows the 'Serial Port 2 Configuration' screen in the Aptio Setup Utility. The title bar reads 'Aptio Setup Utility - Copyright (C) 2011 American Megatrends, Inc.' and the current menu is 'Advanced'. The main area is divided into two columns. The left column contains the title 'Serial Port 2 Configuration', the current setting 'Serial Port [Enabled]', the status 'Device Settings Reset Required', and a blue link 'Change Settings [IO=2E8h; IRQ=5;]'. The right column contains the title 'Enable or Disable Serial Port (COM)' and a list of navigation and function keys: '←→ : Select Screen', '↑↓ : Select Item', 'Enter : Select', '+/- : Change Opt.', 'F1: General Help', 'F2: Previous Values', 'F3: Optimized Defaults', 'F4: Save & Exit', and 'ESC: Exit'. A footer bar at the bottom reads 'Version 2.14.1219. Copyright (C) 2011 American Megatrends, INC.'

### □ Serial Port

Use this option to enable or disable the serial port.

### □ Change Settings

Use this option to change the serial port IO port address and interrupt address.

## 2.15 Chipset

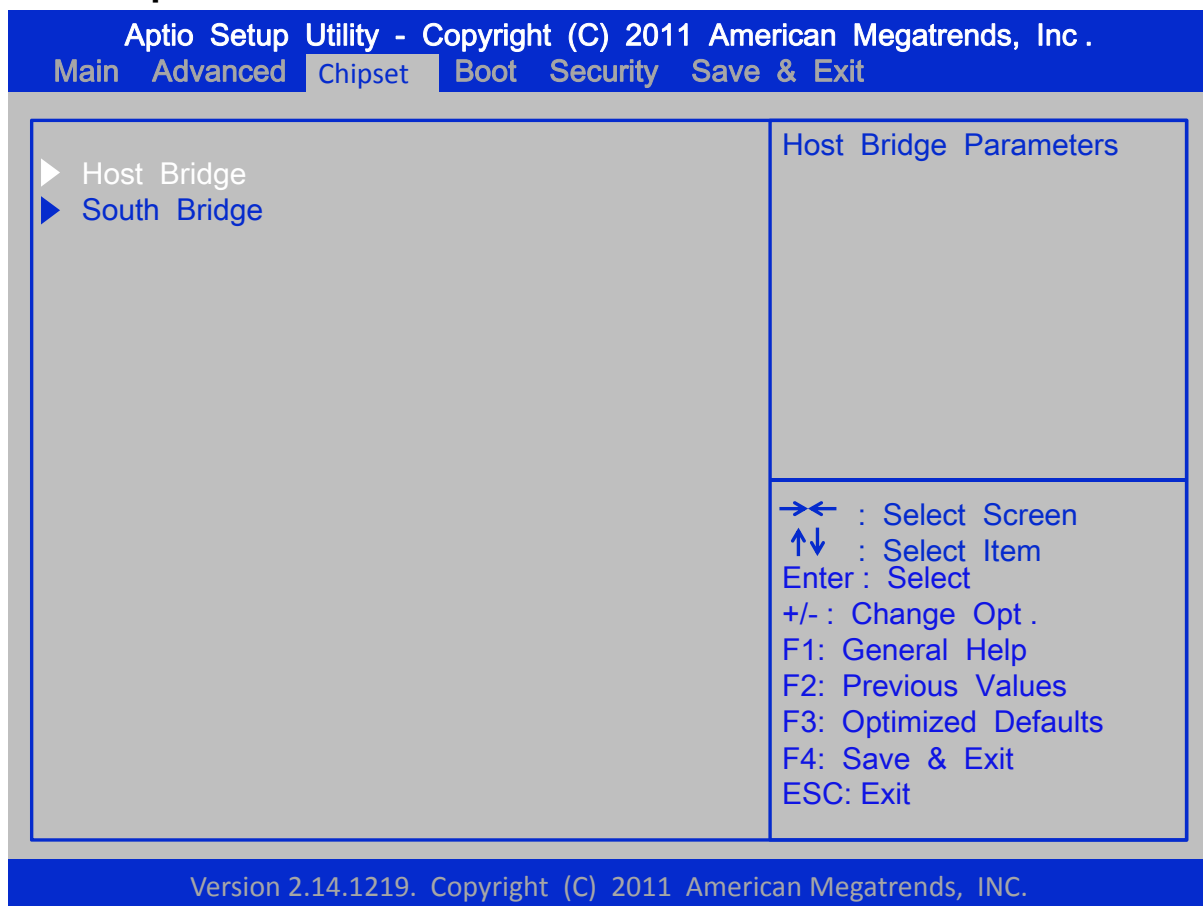

**Host Bridge**

**South Bridge**

## 2.16 Memory Information

Aptio Setup Utility - Copyright (C) 2011 American Megatrends, Inc.

Chipset

<p>▶ Memory Frequency and Timing ▶ Intel IGD Configuration</p> <p>***** Memory Information ***** Memory Frequency      1067MHZ(DDR3) Total Memory            2048 MB DIMM#0                    Not Present</p>	<p>Config Memory Frequency and Timing Settings.</p> <p>→← : Select Screen ↑↓ : Select Item Enter : Select +/- : Change Opt . F1: General Help F2: Previous Values F3: Optimized Defaults F4: Save &amp; Exit ESC: Exit</p>
--	--

Version 2.14.1219. Copyright (C) 2011 American Megatrends, INC.

Memory Frequency and Timing

Intel IGD Configuration

## 2.17 Chipset Configuration

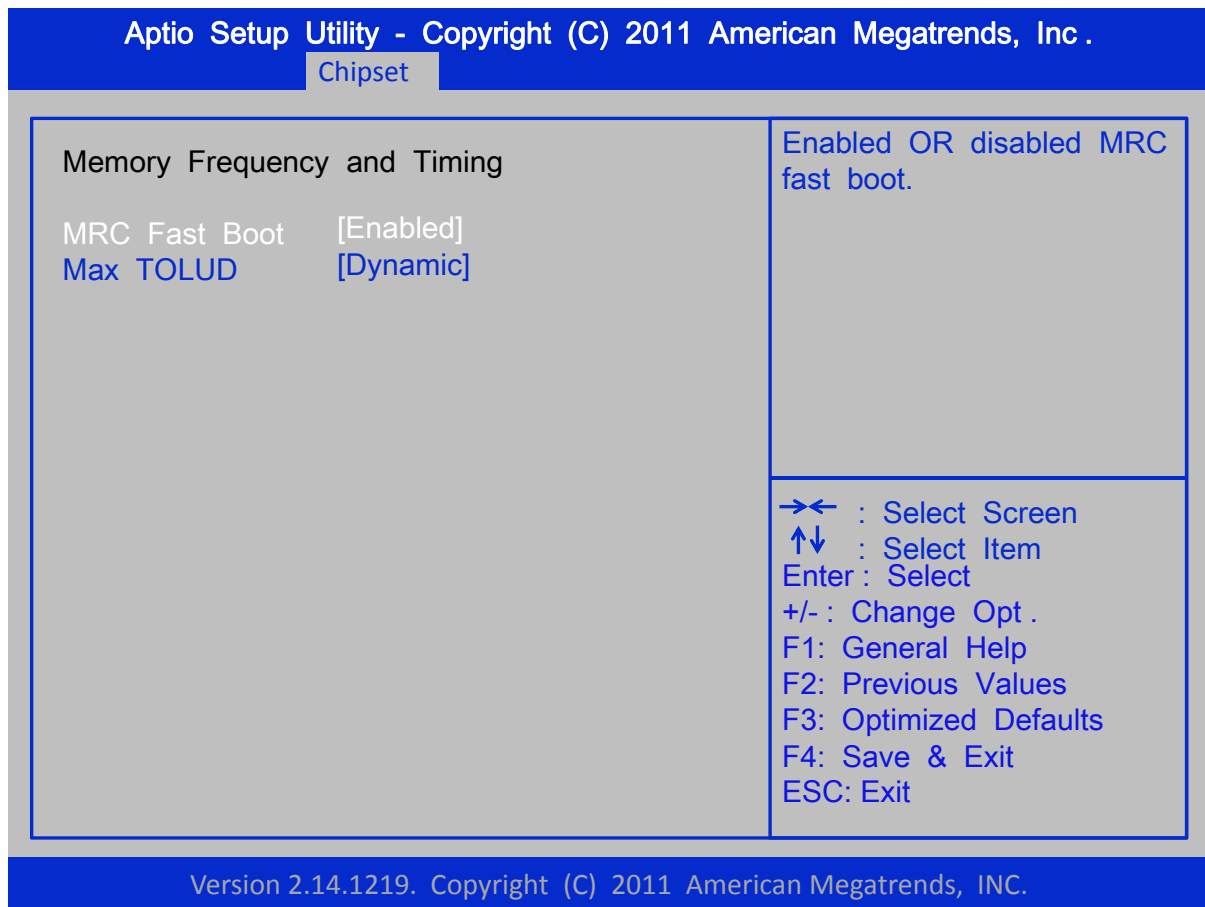

### MRC Fast Boot

Choices: Disabled, Enabled.

### Max TOLUD

This item allows you to select the size of TOLUD.

## 2.18 Intel IGD Configuration

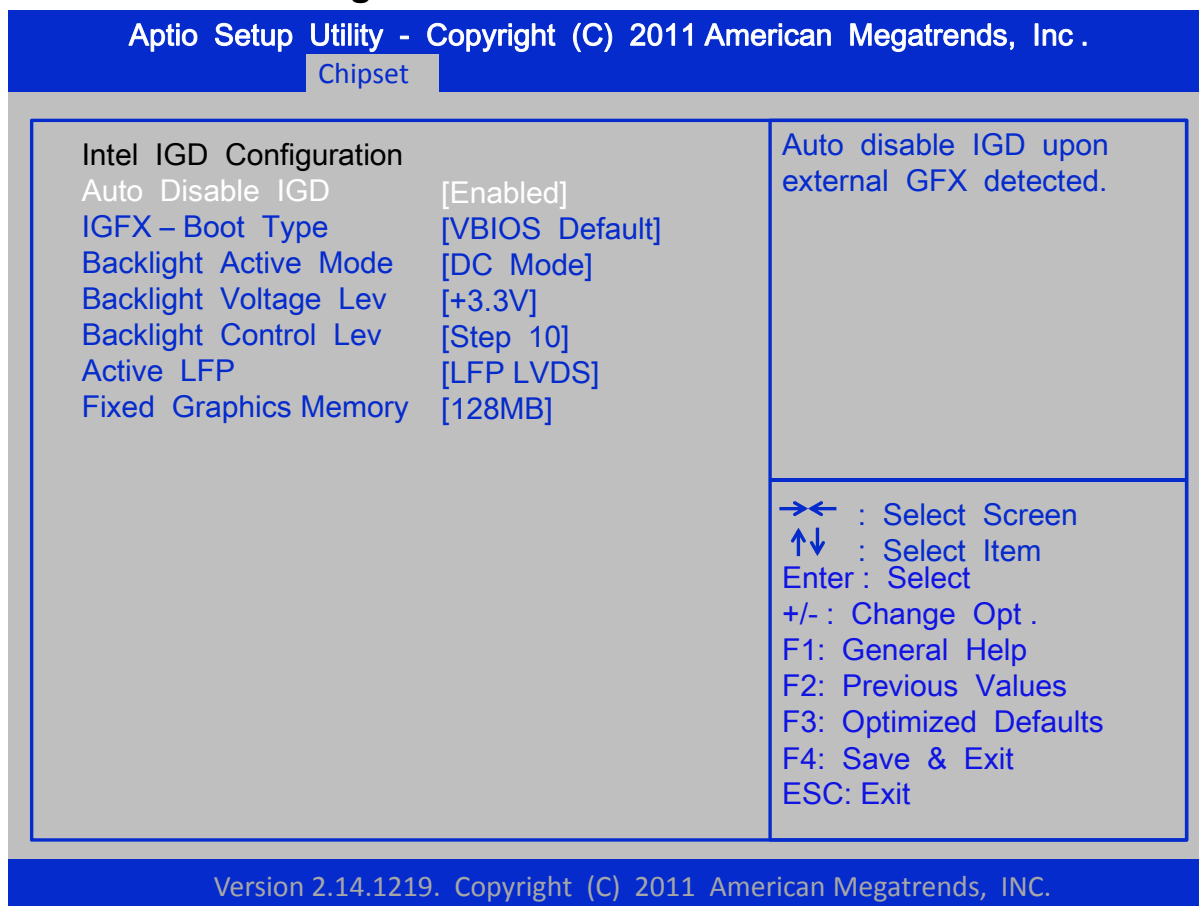

### **Auto Disable IGD**

Choices: Disabled, Enabled.

### **IGFX-Boot Type**

It is the option to select device by the system when it boots.

### **Backlight Active Mode**

Choices: PWN Mode, DC Mode.

### **Backlight Voltage Lev**

Choices: +3.3V, +5V

### **Backlight Control Lev**

Choices: Step1, Step2, Step3, Step4, Step5, Step6, Step7, Step8, Step9, Step10

### **Active LFP**

Choices: LFP LVDS, No LVDS

**Fixed Graphics Memory**

It is used by the Internal graphics device.

## 2.19 PCI Express Root Ports Configuration

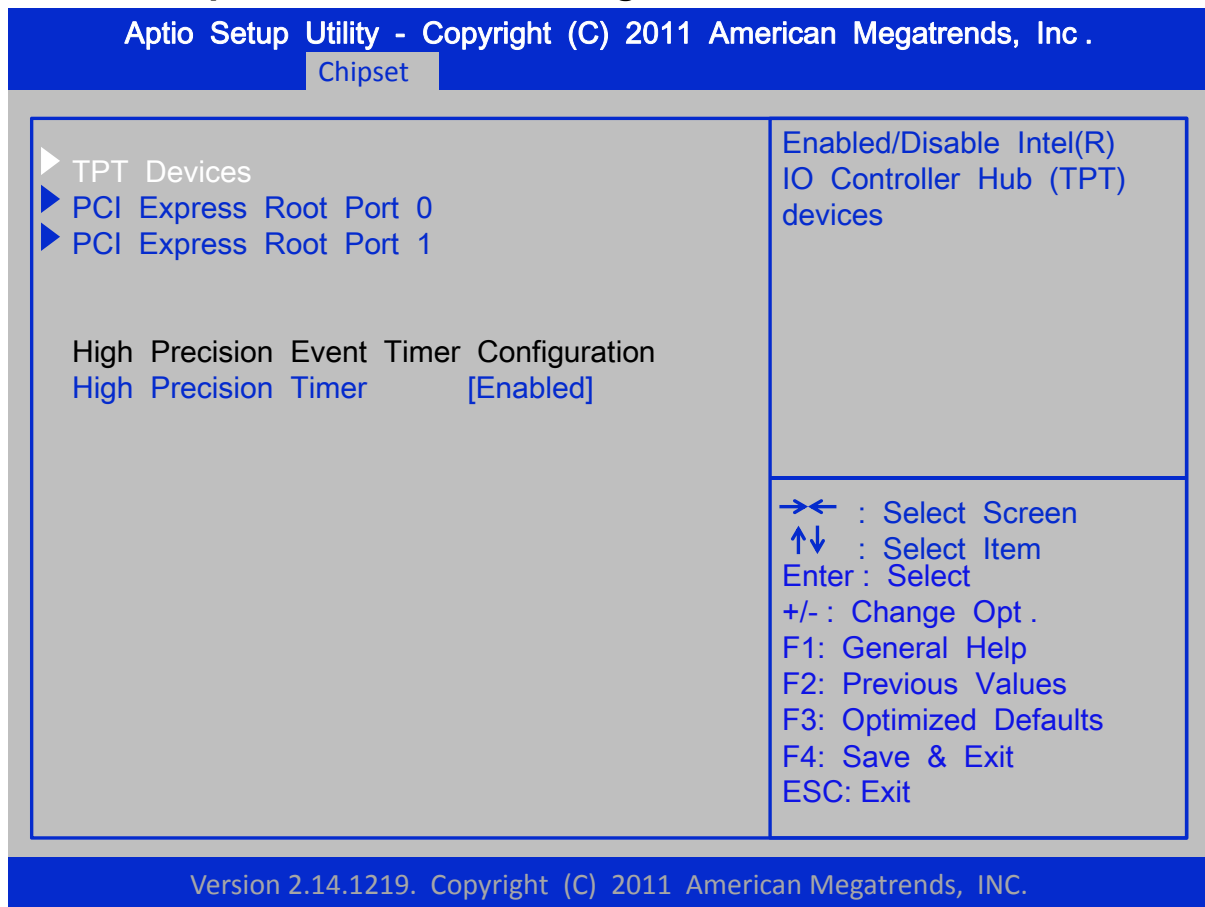

**PCI Express Root Port0**

**PCI Express Root Port1**

**High Precision Event Timer Configuration**

**High Precision Timer**

Choices: Disabled, Enabled.



## 2.20 USB Mode

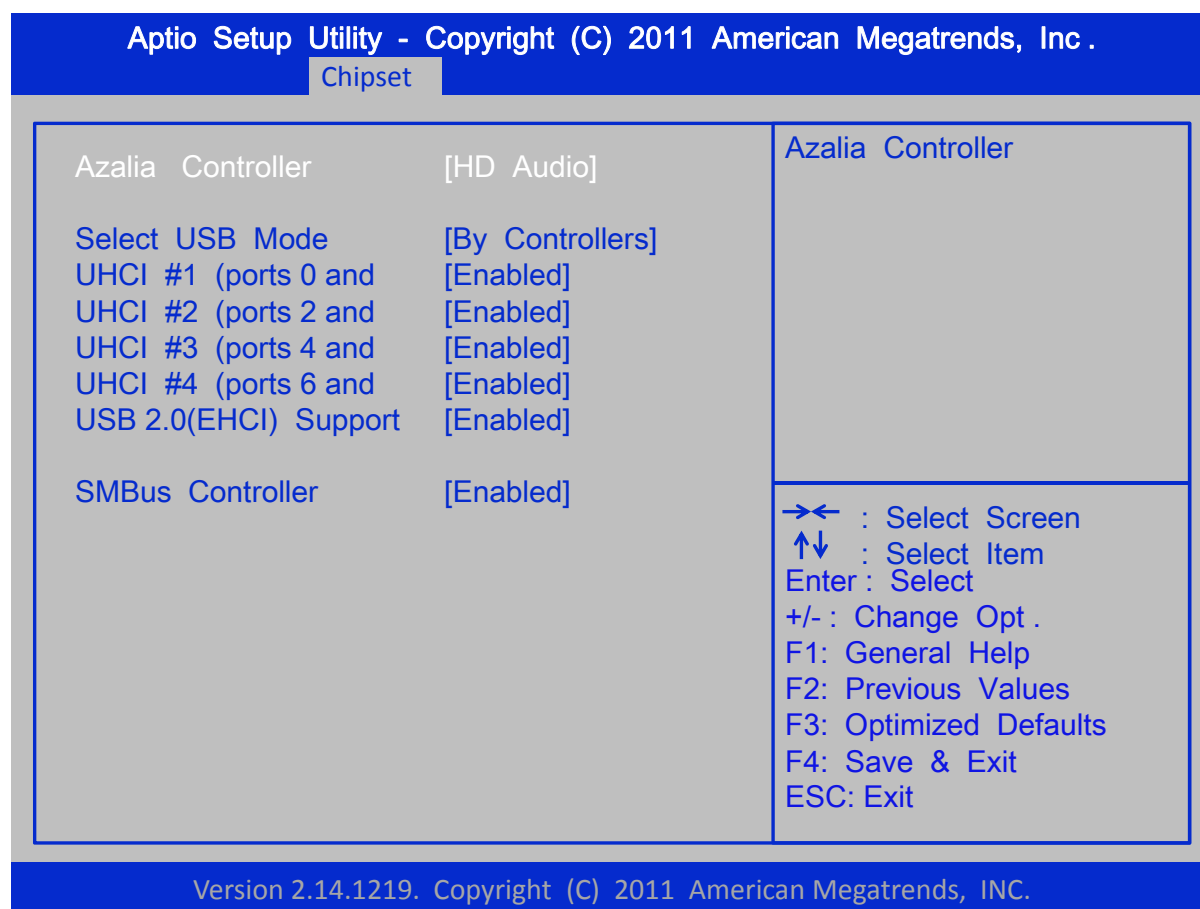

### **Select USB Mode**

Select USB mode by controllers.

### **UHCI #1**

Choices: Disabled, Enabled.

### **UHCI #2**

Choices: Disabled, Enabled.

### **UHCI #3**

Choices: Disabled, Enabled.

### **UHCI #4**

Choices: Disabled, Enabled.

### **USB 2.0 (EHCI) Support**

Choices: Disabled, Enabled.

**SMBus Controller**

Choices: Disabled, Enabled.

## 2.21 PCI Express Ports Configuration

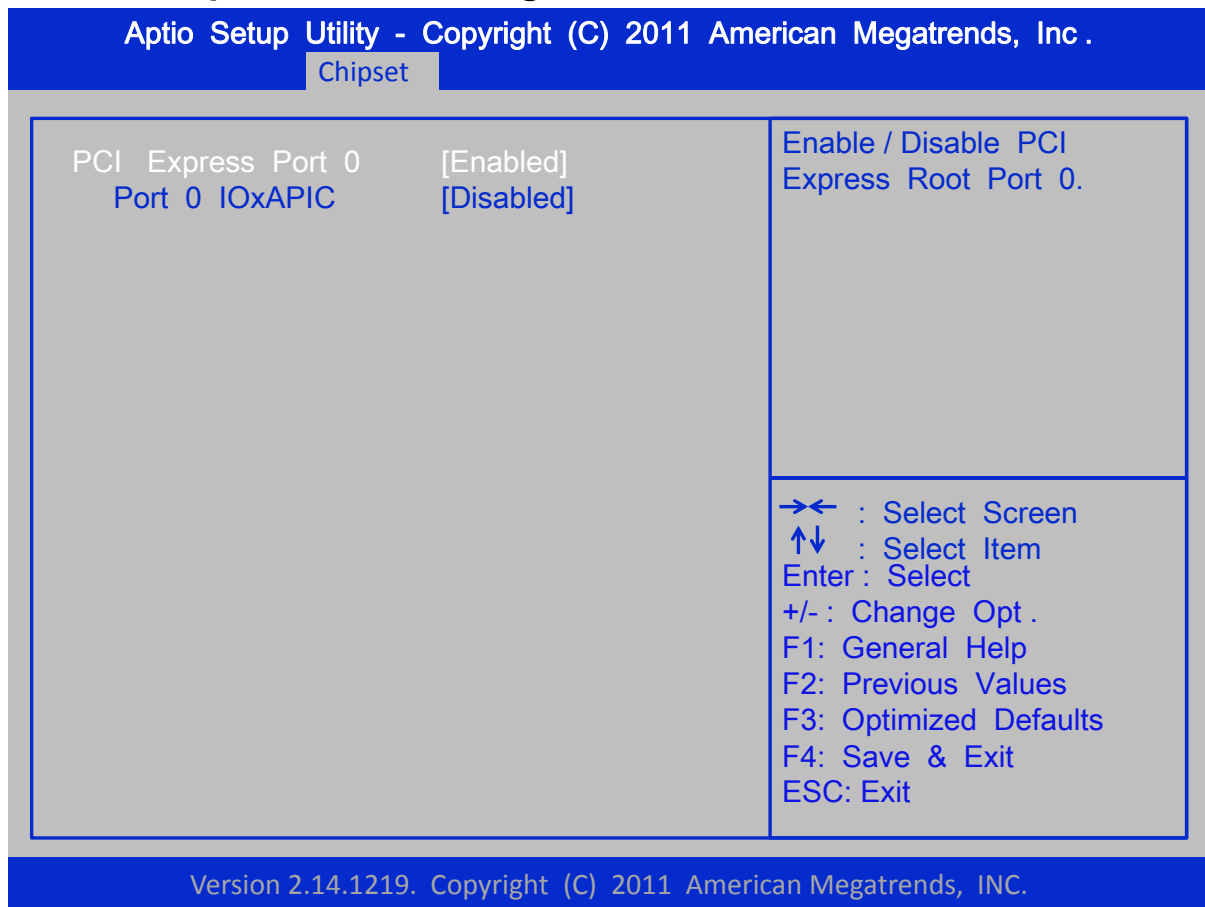

### PCI Express Port0

Choices: Disabled, Enabled.

### Port0

Choices: Disabled, Enabled.

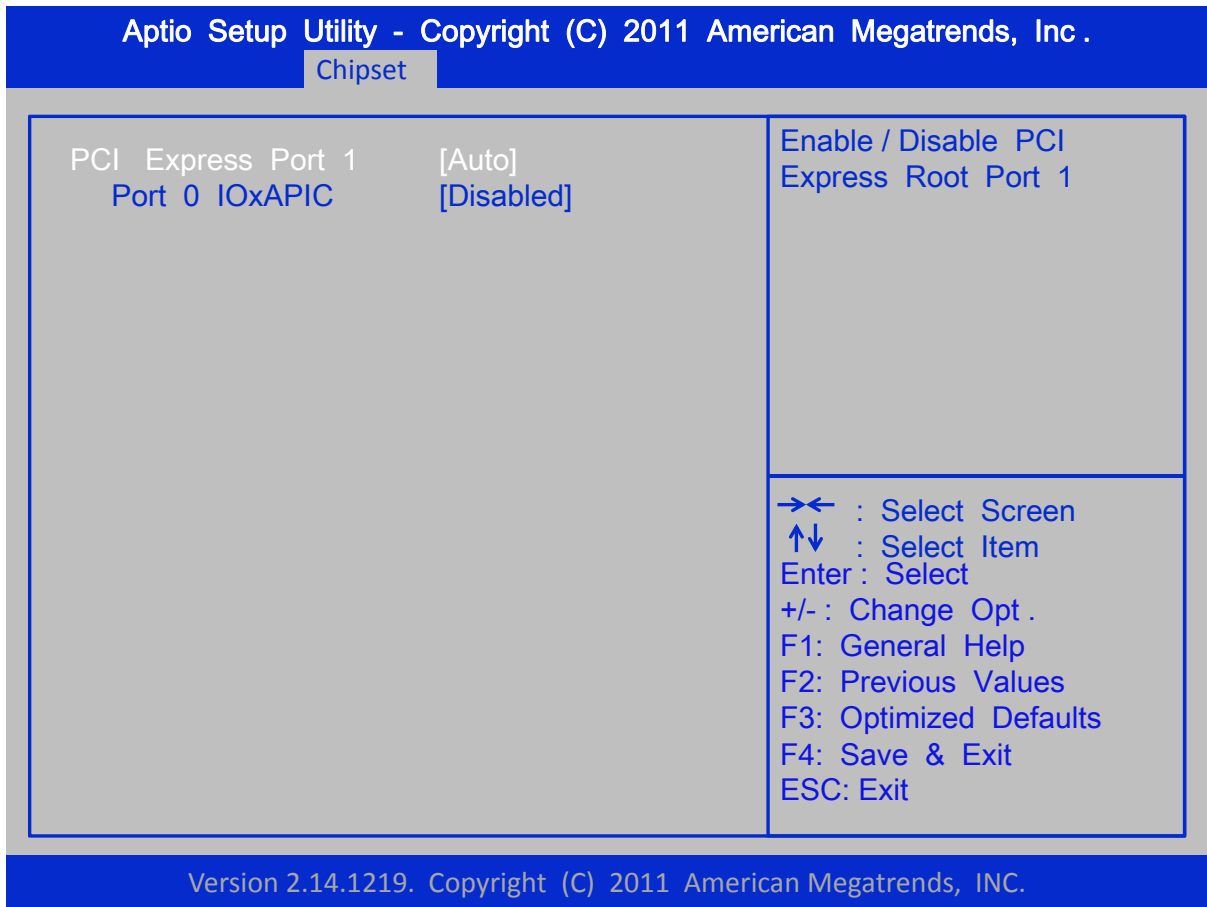

**PCI Express Port1**

PCI Express function is set automatically.

**Port0**

Choices: Disabled, Enabled.

## 2.22 Boot Configuration

Aptio Setup Utility - Copyright (C) 2011 American Megatrends, Inc.					
Main	Advanced	Chipset	Boot	Security	Save & Exit
Boot Configuration Setup Prompt Timeout <b>1</b> Bootup NumLock State [On]  Quiet Boot [Disabled]  CSM16 Module Version 07.68  GateA20 Active [Upon Request] Option ROM Messages [Force BIOS] Interrupt 19 Capture [Enabled] CSM Support [Enabled]  Boot Option Priorities Boot Option #1 [UEFI: USB FLASH D..] Boot Option #2 [ USB FLASH DRIVE PMAP ]  Hard Drive BBS Priorities			Number of seconds to wait for setup activation key. 65535(0xFFFF) means indefinite waiting.  →← : Select Screen ↑↓ : Select Item Enter : Select +/- : Change Opt . F1: General Help F2: Previous Values F3: Optimized Defaults F4: Save & Exit ESC: Exit		
Version 2.14.1219. Copyright (C) 2011 American Megatrends, INC.					

### Setup Prompt Timeout

This setting is to remind when the system is waiting for setup activation key.

### Bootup NumLock State

This setting is to set Num Lock status when the system is powered on. Setting to [On] will turn on the Num Lock key when the system is powered on. Setting to [Off] will allow users to use the arrow keys on the numeric keypad. Choices: On, Off.

### Quiet Boot

This item can help to select the screen display when the system boots.

### GateA20 Active

Upon request GA20 can be disabled using BIOS services.

### Option ROM Messages

Set display mode for option ROM.

**Interrupt 19 Capture**

Enable: Allow option ROMs to trap into 19.

Choices: Disabled, Enabled.

**CSM Support**

Enable: Set mode for option CSM.

Choices: Disabled, Enabled.

**Boot Option Priority**

These items specify the boot device priority sequence from the available devices. The number of device items that appears on the screen depends on the number of devices installed in the system.

Choices: Boot Option#1, Boot Option#2.

## 2.23 Password Description

Aptio Setup Utility - Copyright (C) 2011 American Megatrends, Inc.					
Main Advanced Chipset Boot Security Save & Exit					
<p>Password Description</p> <p>If ONLY the Administrator's password is set , then this only limits access to Setup and is only asked for when entering Setup.</p> <p>If ONLY the User's password is set, then this is a power on password and must be entered to boot or enter Setup. In Setup the User will have Administrator rights.</p> <p>The password length must be in the following range:</p> <table> <tr> <td>Minimum length</td> <td>3</td> </tr> <tr> <td>Maximum length</td> <td>20</td> </tr> </table> <p>Administrator Password User Password</p>	Minimum length	3	Maximum length	20	<p>Set Administrator Password</p> <hr/> <p>→← : Select Screen            ↑↓ : Select Item            Enter : Select            +/- : Change Opt .            F1: General Help            F2: Previous Values            F3: Optimized Defaults            F4: Save ESC: Exit</p>
Minimum length	3				
Maximum length	20				
Version 2.14.1219. Copyright (C) 2011 American Megatrends, INC.					

## 2.24 Save Changes and Exit

Aptio Setup Utility - Copyright (C) 2011 American Megatrends, Inc.

Main Advanced Chipset Boot Security **Save & Exit**

Save Changes and Exit Discard Changes and Exit Save Changes and Reset Discard Changes and Reset	Exit system setup after saving the changes.
Save Options Save Changes Discard Changes	
Restore Defaults Save as User Defaults Restore User Defaults	
Boot Override UEFI: USB FLASH DRIVE PMAP USB FLASH DRIVE PMAP	
	→← : Select Screen ↑↓ : Select Item Enter : Select +/- : Change Opt . F1: General Help F2: Previous Values F3: Optimized Defaults F4: Save & Exit ESC: Exit

Version 2.14.1219. Copyright (C) 2011 American Megatrends, INC.



## Chapter 3 Drivers Installation

This chapter introduces driver installation information.

Please insert the utility CD to CD-ROM drive, the install menu will appear automatically, if the install menu did not list suitable driver of Operate System or did not appear automatically, please select corresponding driver of utility CD to install.

Driver installation steps are as below.

### 3.1 Intel Chipset Device Software

**Step 1.** Click “Next” to continue.



**Step 2.** Read the License Agreement and click “Yes” to continue.



**Step 3.** Click “Next” to continue.



**Step 4.** Click “Next” to continue.

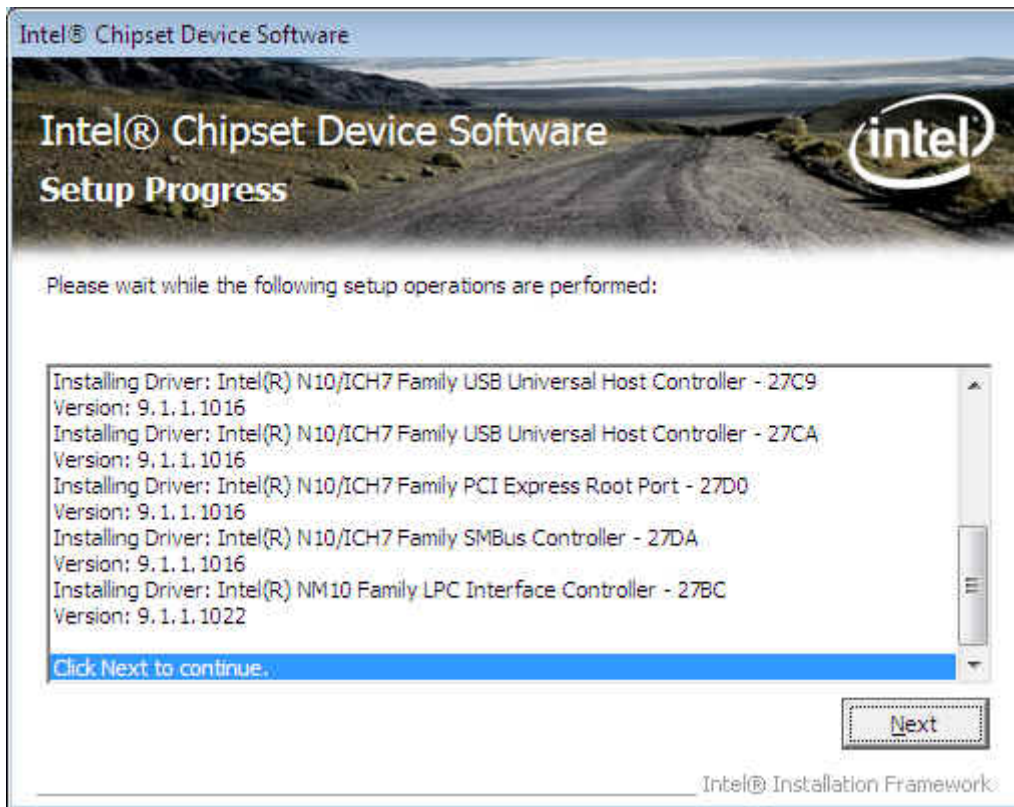

**Step 5.** Click “Finish” to complete setup.





## 3.2 Intel Graphic Media Accelerator Driver

**Step 1.** Click “Next” to continue.

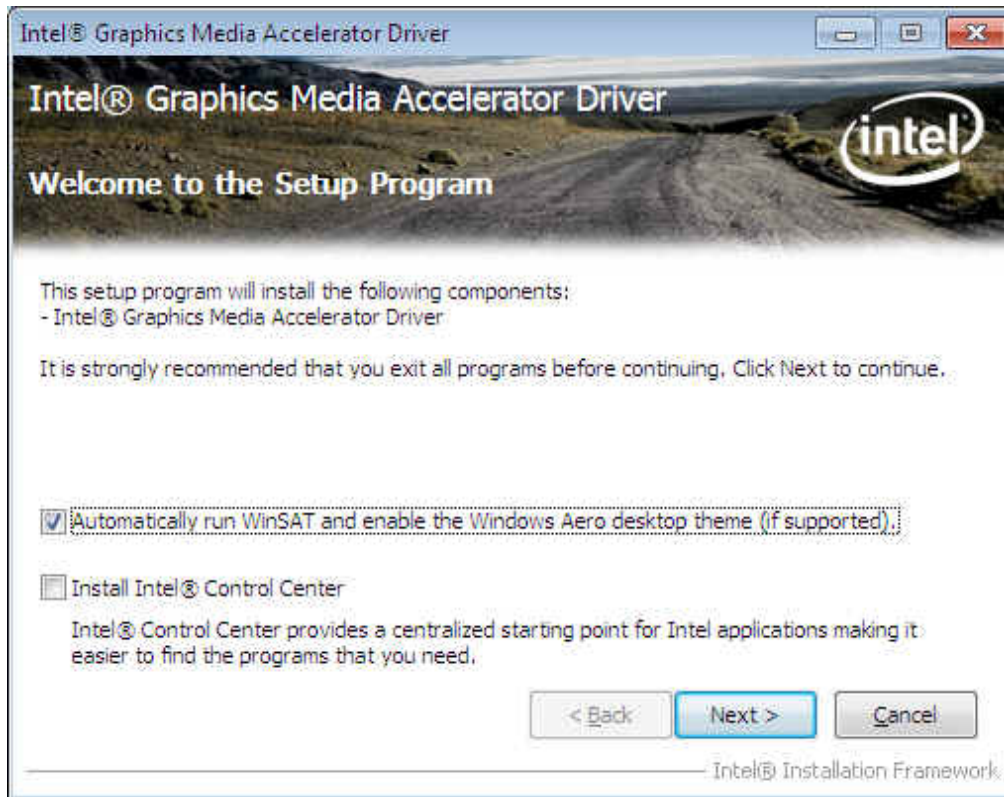

**Step 2.** Click “No” to continue.

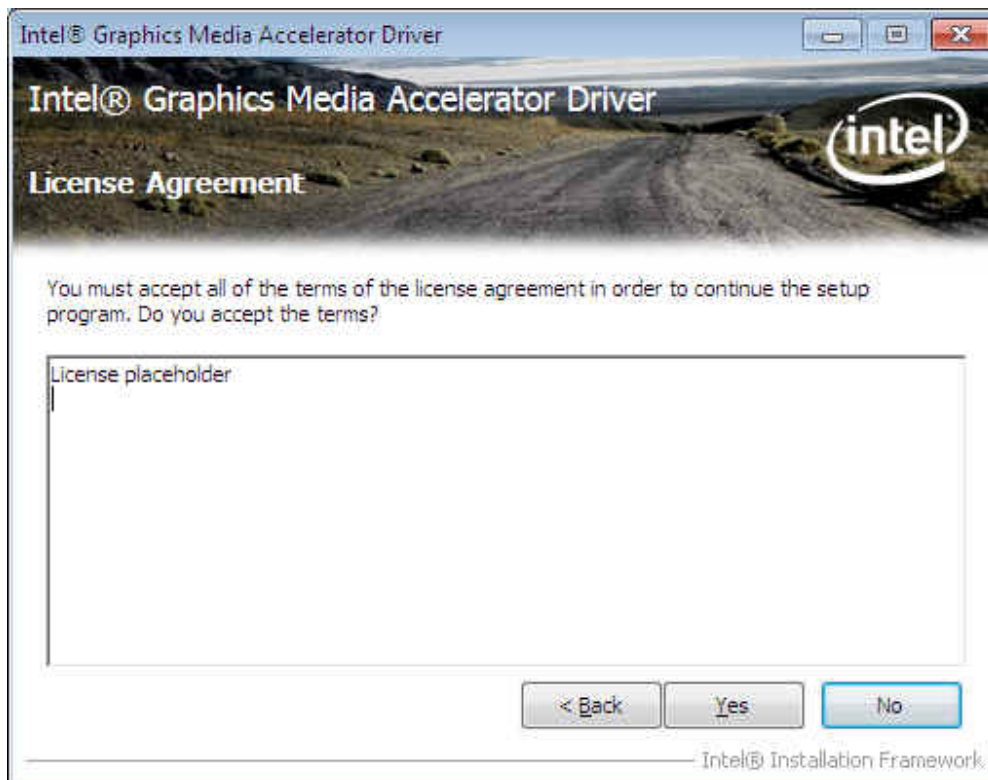

**Step 3.** Click “Next” to continue.

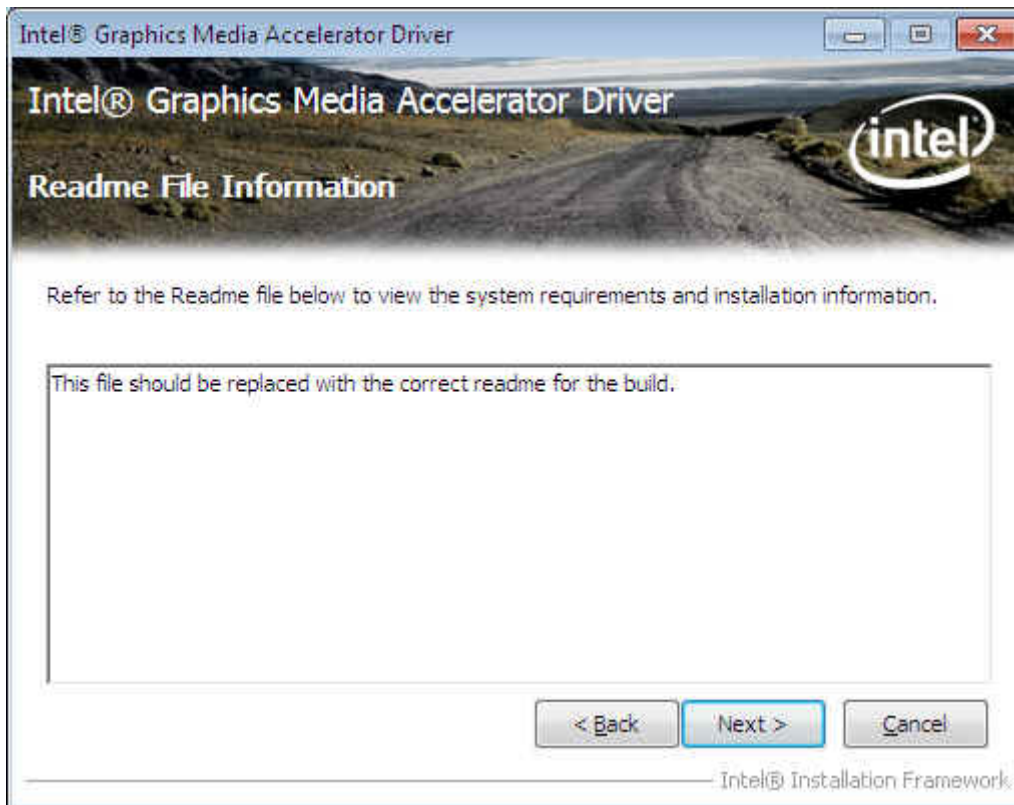

**Step 4.** Click “Next” to continue.

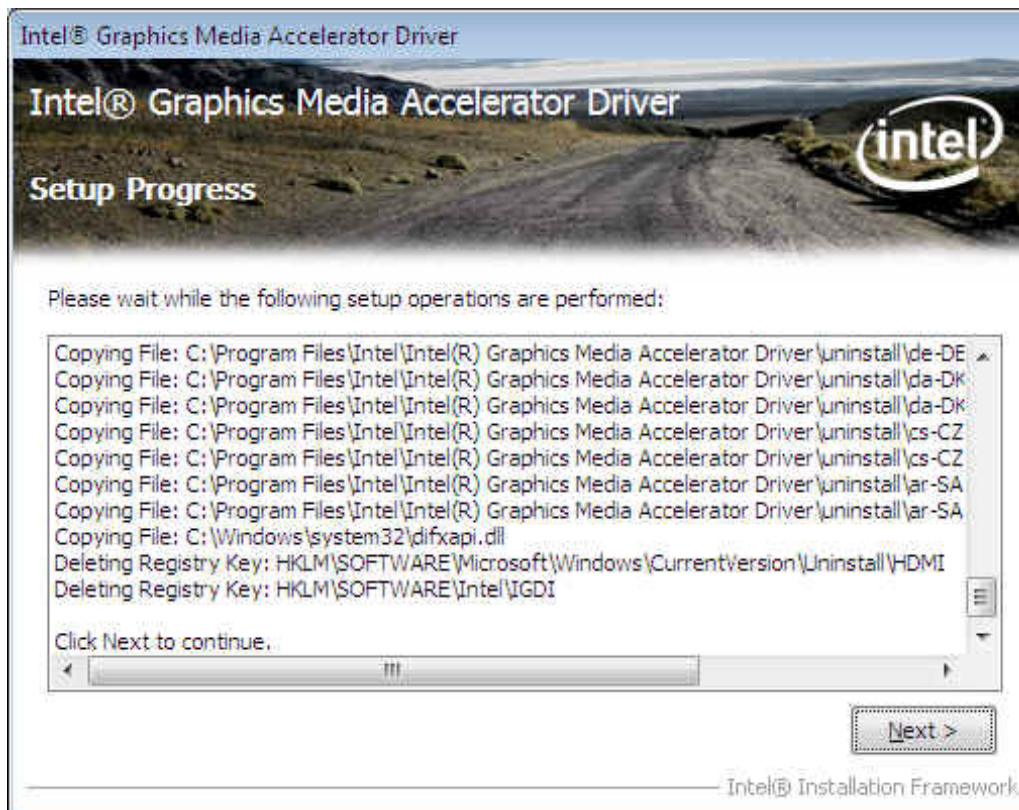

**Step 5.** Click “Finish” to complete setup.



### 3.3 LAN Driver

**Step 1.** Click “Next” to continue.

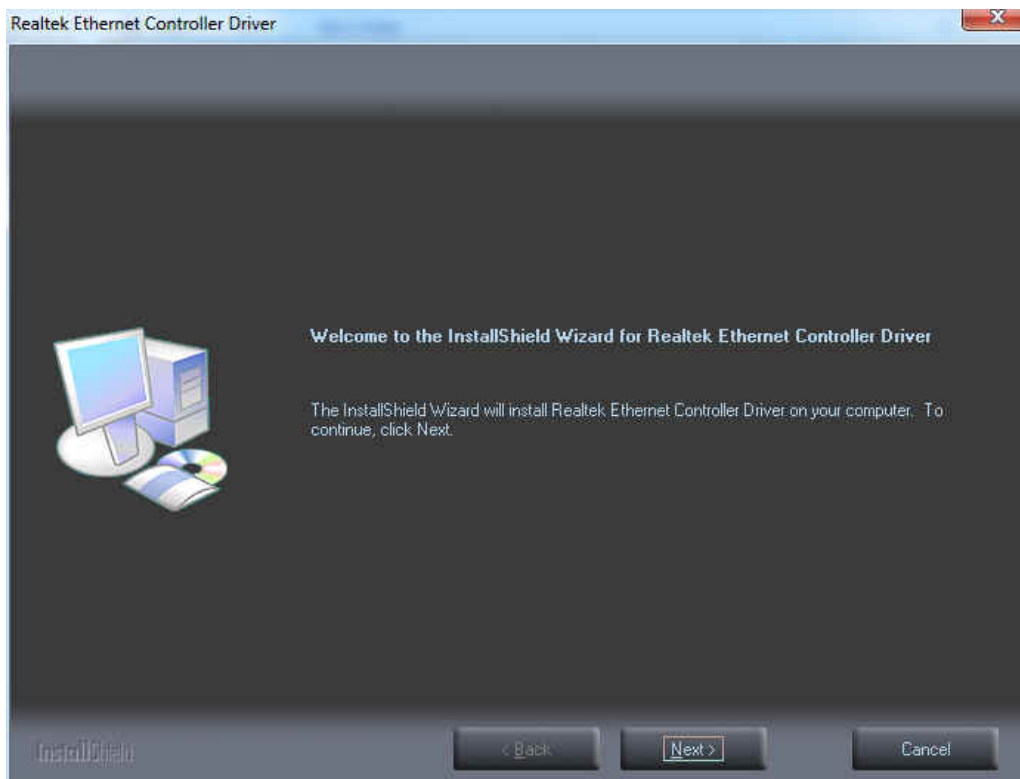

**Step 2.** Click “Install” to continue.

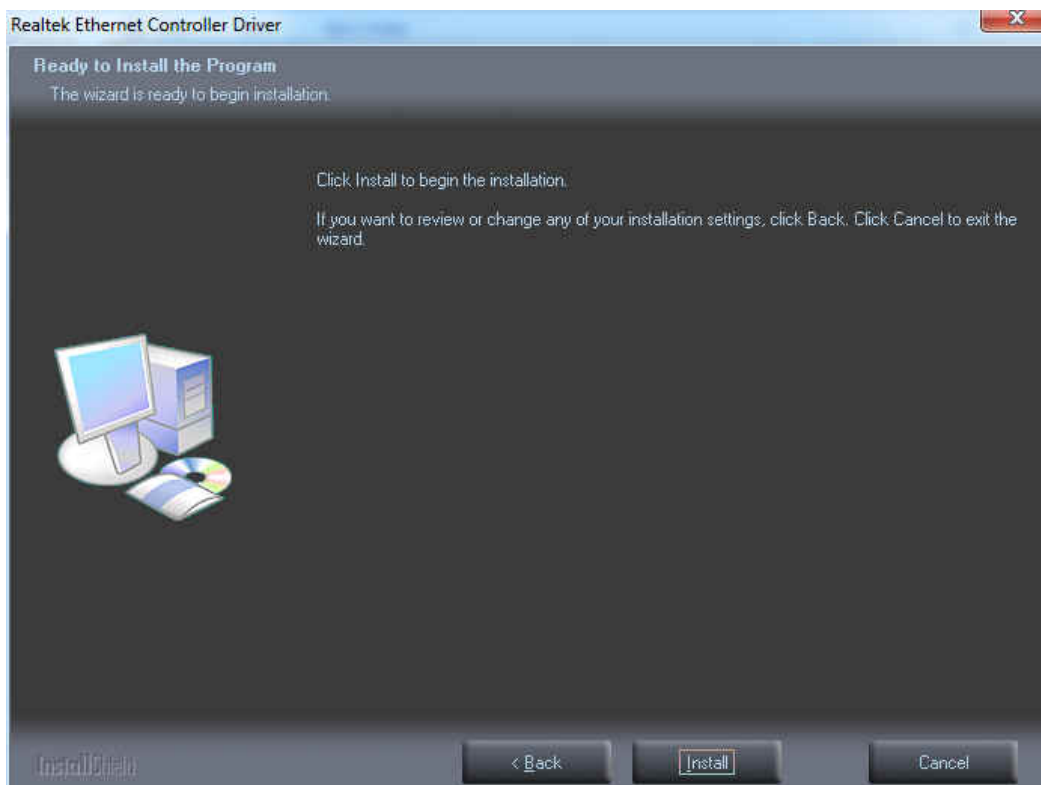

**Step 3.** Click “Finish” to complete setup.

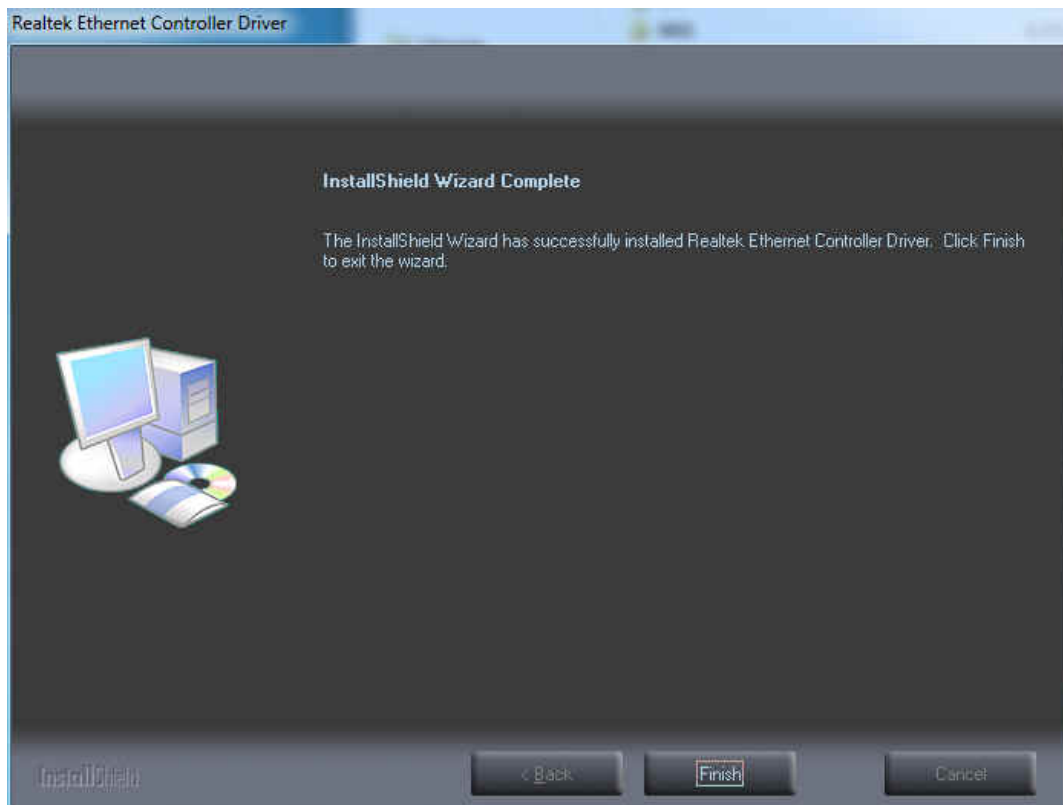



### 3.4 Audio Driver

**Step 1.** Click “Next” to continue.

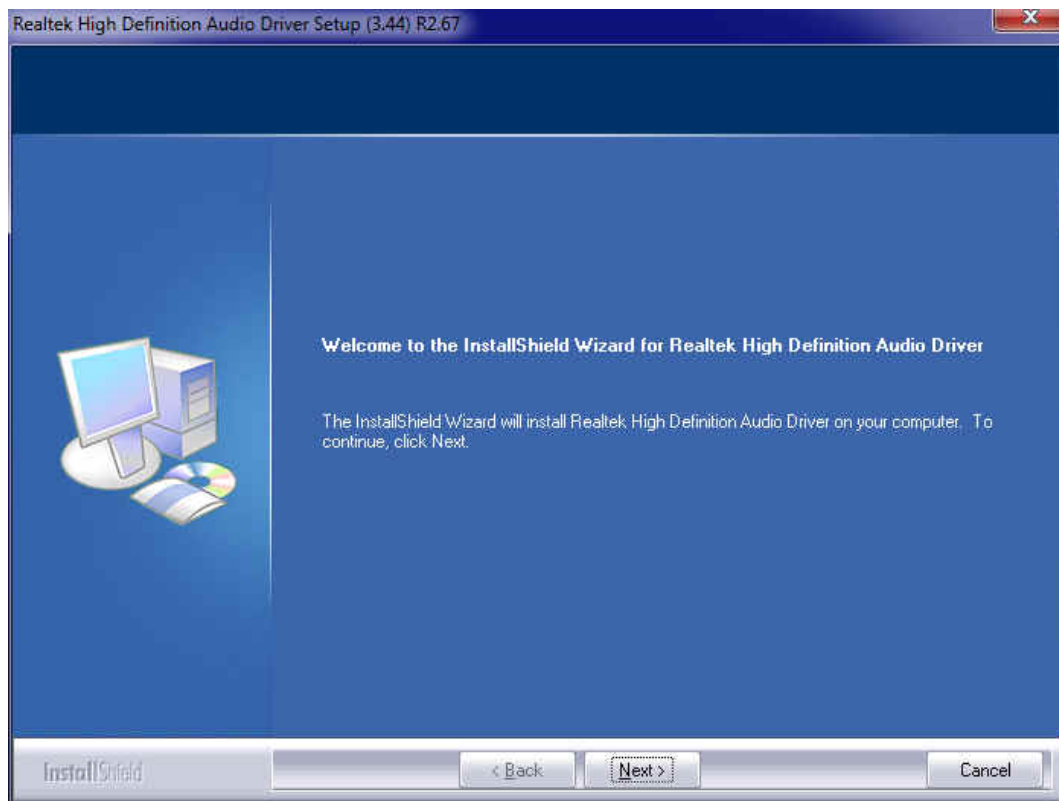

**Step 2.** Click “Finish” to complete setup.

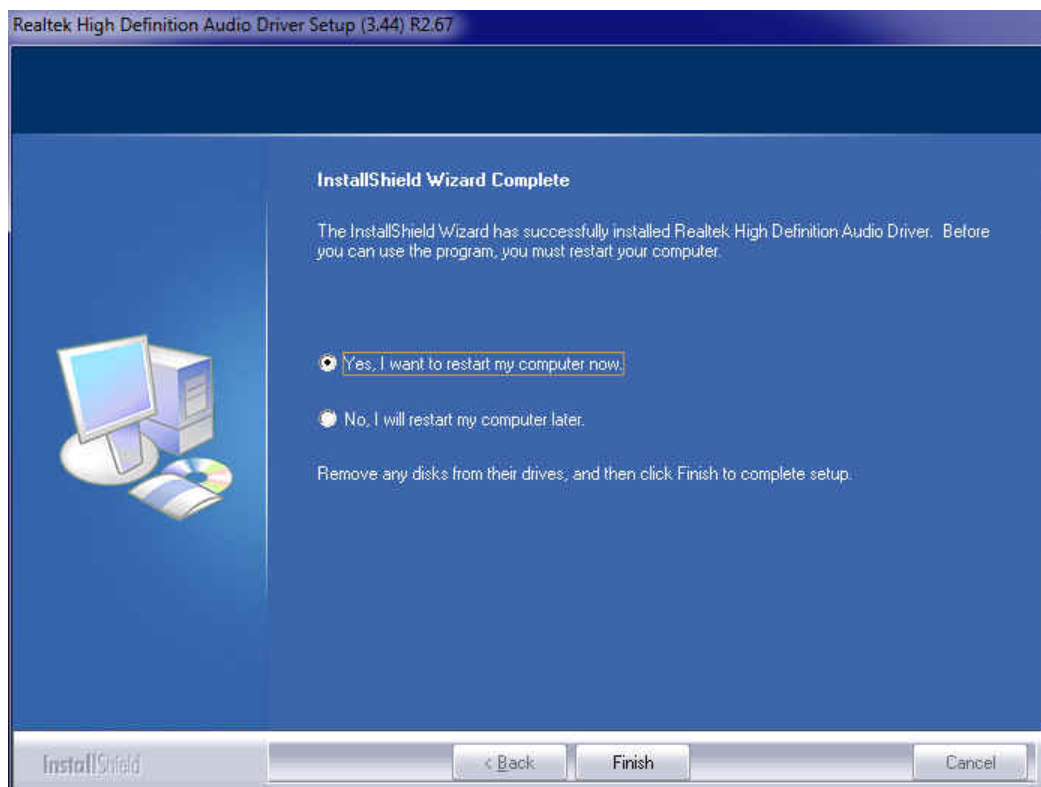

## Appendix-A Watchdog

The working algorithm of the WDT function can be simply described as a counting process. The time-out Interval can be set through software programming. The availability of time-out interval is set by software.

The System Board allows users control WDT through dynamic software programming. The WDT starts counting when it is activated. It sends out a signal to system reset, when time-out interval ends. To prevent the time-out interval from running out, a re-trigger signal will need to be sent before the counting reaches its end. This action will restart the counting process.

WDT program should keep the counting process running under normal condition. WDT should never generate a system reset unless the system runs into troubles.

The related Control Registers of WDT are all included in the following sample program that is written in C language. User can fill a non-zero value into the Time-out Value Register to enable/refresh WDT. System will be reset after the Time-out Value to be counted down to zero. Or user can directly fill a zero value into Time-out Value Register to disable WDT immediately.

To ensure a successful accessing to the content of desired Control Register, the sequence of following program codes should be step-by-step run again when each register is accessed.

For more information about WDT, please refer to Winbond W83627EHF data sheet.

There are two PnP I/O port addresses that can be used to configure WDT,

- 1) 0x2E: EFIR (Extended Function Index Register, for identifying CR index number)
- 2) 0x2F: EFDR (Extended Function Data Register, for accessing desired CR)

Below are some example codes, which demonstrate the use of WDT.

```

// Enter Extended Function Mode
outp(0x002E, 0x87);
outp(0x002E, 0x87);

// Assign Pin 77 to be a WDTO# Signal
outp(0x002E, 0x2D);
outp(0x002F, inp(0x002F) & 0xFE);

// Select Logic Device 8
outp(0x002E, 0x07);
outp(0x002F, 0x08);

// Active Logic Device 8
outp(0x002E, 0x30);
outp(0x002F, 0x01);

//Clear WDTO# Status
outp(0x002E, 0xF7);
outp(0x002F, inp(0x2F) & 0xEF);

// Select Count Mode (Second / Minute)
outp(0x002E, 0xF5);
outp(0x002F, (inp(0x002F) & 0xF7) | (Count-mode Register & 0x08));

// Set Time-out Value
outp(0x002E, 0xF6);
outp(0x002F, Time-out Value Register);

// Exit Extended Function Mode
outp(0x002E, 0xAA);

```

## Definitions of Variables:

Value of **Count-mode Register**:

- 1) 0x00 -- Count down in seconds (Bit3=0)
- 2) 0x08 -- Count down in minutes (Bit3=1)

Value of **Time-out Value Register**:

- 1) 0x00 -- Time-out Disable
- 2) 0x01~0xFF -- Value for counting down

## Appendix-B GPIO

The System Board provides 4 dedicated output ports and 4 programmable I/O ports that can be individually configured to perform a simple I/O function. Users can configure 4 programmable I/O ports to become an input or output port by programming register bit of I/O Selection . *To invert port value, the setting of Inversion Register has to be made* (Note). Port values can be set to read or write through Data Register.

Note: Only 4 programmable I/O ports support.

Additionally, 4 Digital Output ports amplified signals from GPIO ports. There are open-drain buffers, which can offer greater driving capacity up to 100mA.

For more information about GPIO, please refer to Winbond W83627EHF data sheet.

The related Control Registers of GPIO are all included in the following sample program that is written in C language. To ensure a successful accessing to the content of desired Control Register, the sequence of following program codes should be step-by-step run again when each register is accessed.

There are two PnP I/O port addresses that can be used to configure GPIO ports,

- 1) 0x2E - EFER (Extended Function Enable Register, for entering Extended Function Mode)
  - EFIR (Extended Function Index Register, for identifying CR index number)
- 2) 0x2F - EFDR (Extended Function Data Register, for accessing desired CR)

Below are some example codes, which demonstrate the use of GPIOs.

```
// Enter Extended Function Mode
outp(0x002E, 0x87);
outp(0x002E, 0x87);

// Assign Pin121-128 to be GPIO port
outp(0x002E, 0x29);
outp(0x002F, inp(0x002F) | 0x01);
```

```

// Select Logic Device 7
outp(0x002E, 0x07);
outp(0x002F, 0x07);

// Active Logic Device 7
outp(0x002E, 0x30);
outp(0x002F, 0x01);

// Select Inversion Mode
outp(0x002E, 0xF2);
outp(0x002F, (inp(0x002F) & 0x3C) | (Inversion Register & 0xC3));

// Select I/O Mode
outp(0x002E, 0xF0);
outp(0x002F, (inp(0x002F) & 0x3C) | (I/O Selection Register & 0xC3));

// Access GPIO ports
outp(0x002E, 0xF1);
outp(0x002F, (inp(0x002F) & 0x3C) | (Output Data & 0xC3));
or
Input Data = inp(0x002F);

// Exit Extended Function Mode
outp(0x002E, 0xAA);

```

## Definitions of Variables:

Each bit in the lower nibble of each Register represents the setting of a GPIO port.

Super IO Pin	Bit	GPIO DIO
128	0	GPIO DIO-Out0
127	1	GPIO DIO-Out1
126	2	GPIO DIO-In0
125	3	GPIO DIO-In1
124	4	GPIO DIO-In2
123	5	GPIO DIO-In3

122	6	GPIO DIO-Out2
121	7	GPIO DIO-Out3

Value of **Inversion Register**:

When set to a '1', the incoming/outgoing port value is inverted.

When set to a '0', the incoming/outgoing port value is the same as in Data Register.

Value of **I/O Selection Register**:

When set to a '1', respective GPIO port is programmed as an input port.

When set to a '0', respective GPIO port is programmed as an output port.

Value of **Output Data** / **Input Data**:

If a port is assigned to be an output port, then its respective bit can be read/written.

If a port is assigned to be an input port, then its respective bit can be read only.

Note:

**DIO\_IN0/DIO\_IN1/DIO\_IN2/DIO\_IN3** is programmed as **Inputs** by BIOS default.

Parameter	Conditions
VinH	min +1.857V
VinL	max +0.525V
Rated Vin	-8V ~ +12V
NC Status	High by Default

\*\* Attention: If **DIO\_IN0/DIO\_IN1/DIO\_IN2/DIO\_IN3** is programmed as Output signal, they can only offer a normal signal transfer (NOT amplified signals).

Parameter	Conditions
VoutH	3.3V thru 10k
VoutL	0V thru 1k

**DIO\_OUT0/DIO\_OUT1/DIO\_OUT2/DIO\_OUT3** is fixed as **Outputs** by BIOS.

Parameter	Conditions
Open-drain buffer	Power-on default = Open
Driving Capacity	max 100mA continue