

## OVERVIEW

The 5076 series are miniature VCXO ICs that provide a wide frequency pulling range, even when using miniature crystal units for which a wide pulling range is difficult to provide. They employ a recently developed varicap diode fabrication process that provides a wide frequency pulling range and good linearity without any external components. Also, they employ a regulated voltage drive oscillator circuit that significantly reduces current consumption, crystal current, and oscillation characteristics supply voltage dependency. The 5076 series are ideal for miniature, wide pulling range, low power consumption, VCXO modules.

## FEATURES

- VCXO with recently developed varicap diode built-in
- New fabrication process that significantly reduces parasitic capacitance and provides wide pulling range even when using miniature crystal units
- Regulated voltage drive oscillator circuit for reduced power consumption, crystal drive current, and oscillation characteristics voltage dependency
- Wide frequency pulling range
  - $\pm 160\text{ppm}$  (B1 version,  $f = 27\text{MHz}$ )  
(Crystal:  $\gamma = 300$ ,  $C_0 = 1.5\text{pF}$ )
- Operating supply voltage range: 1.6V to 2.0V
- Oscillation frequency range (for fundamental oscillation): 20MHz to 55MHz (varies with version)
- Low current consumption: 0.5mA  
(B1 version,  $f = 27\text{MHz}$ , no load,  $V_{DD} = 1.8\text{V}$ )
- Frequency divider built-in
  - Selectable by version:  $f_O$ ,  $f_O/2$ ,  $f_O/4$ ,  $f_O/8$ ,  $f_O/16$
  - Frequency divider output for 1.3MHz (min) low frequency output
- VC pin input resistance:  $10\text{M}\Omega$  (min)
- CMOS output
- Two types of pad layout selectable by mounting method
  - A $\times$  version: for Flip Chip Bonding
  - B $\times$  version: for Wire Bonding
- Package: Wafer form (WF5076 $\times\times$ )  
Chip form (CF5076 $\times\times$ )

## APPLICATIONS

- $2.5 \times 2.0\text{mm}$ ,  $3.2 \times 2.5\text{mm}$  size miniature VCXO modules for digital mobile TV tuner, digital TV (PDP, LCD), PND (Personal Navigation Device), etc.

## ORDERING INFORMATION

Device	Package
WF5076 $\times\times$ -4	Wafer form
CF5076 $\times\times$ -4	Chip form

## SERIES CONFIGURATION

Operating supply voltage range [V]	PAD layout	Recommended operating frequency range <sup>1</sup> [MHz]	Output frequency and version name <sup>2</sup>				
			$f_0$ output	$f_0/2$ output	$f_0/4$ output	$f_0/8$ output	$f_0/16$ output
1.6 to 2.0	Flip Chip Bonding	20 to 40	(5076A1)	(5076A2)	(5076A3)	(5076A4)	(5076A5)
		40 to 55	(5076AJ)	(5076AK)	(5076AL)	(5076AM)	(5076AN)
	Wire Bonding	20 to 40	5076B1	(5076B2)	(5076B3)	(5076B4)	(5076B5)
		40 to 55	5076BJ	(5076BK)	(5076BL)	(5076BM)	(5076BN)

\*1. The recommended operating frequency is a yardstick value derived from the crystal used for NPC characteristics authentication. However, the oscillation frequency range is not guaranteed. Specifically, the characteristics can vary greatly due to crystal characteristics and mounting conditions, so the oscillation characteristics of components must be carefully evaluated.

\*2. Versions in parentheses ( ) are under development.

## VERSION NAME

Device	Package	Version name
WF5076××-4	Wafer form	<p style="text-align: center;">WF5076□□-4</p> <p>Form WF: Wafer form    ↑    Oscillation frequency range, frequency divider function</p> <p>CF: Chip (Die) form    ↑    Pad layout type    A: for Flip Chip Bonding</p> <p style="padding-left: 350px;">B: for Wire Bonding</p>
CF5076××-4	Chip form	

**PAD LAYOUT**

(Unit:  $\mu\text{m}$ )

■ 5076A $\times$  (for Flip Chip Bonding)

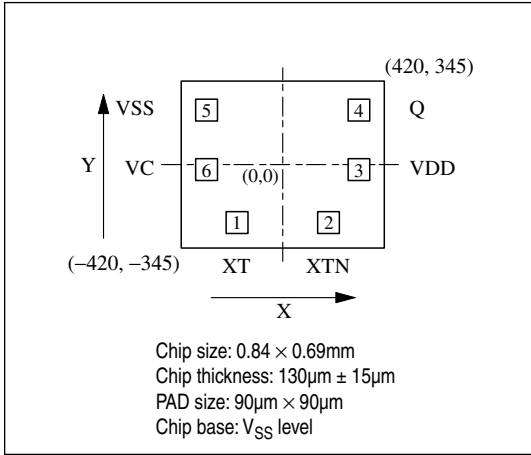

■ 5076B $\times$  (for Wire Bonding)

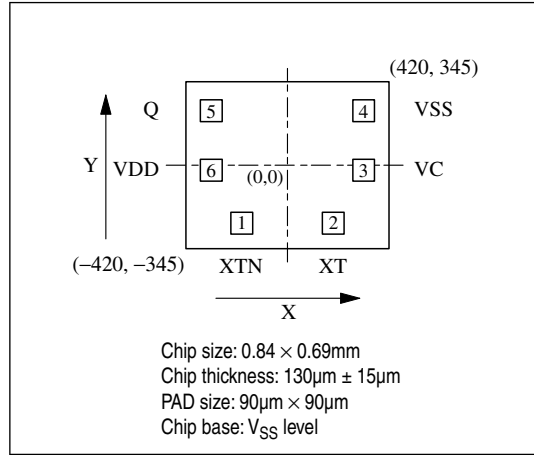

**PAD DIMENSIONS PIN DESCRIPTION**

Pad No.	Pad dimensions [ $\mu\text{m}$ ]		Pad No.		Pin	I/O	Description
	X	Y	5076A $\times$	5076B $\times$			
1	-189	-240	1	2	XT	I	Crystal connection pin (amplifier input)
2	189	-240	2	1	XTN	O	Crystal connection pin (amplifier output)
3	315	-21	3	6	VDD	-	(+) supply pin
4	315	225	4	5	Q	O	Clock output pin
5	-315	225	5	4	VSS	-	(-) supply pin
6	-315	-21	6	3	VC	I	Oscillation frequency control voltage input pin (positive polarity) (frequency increases with increasing voltage)

**BLOCK DIAGRAM**

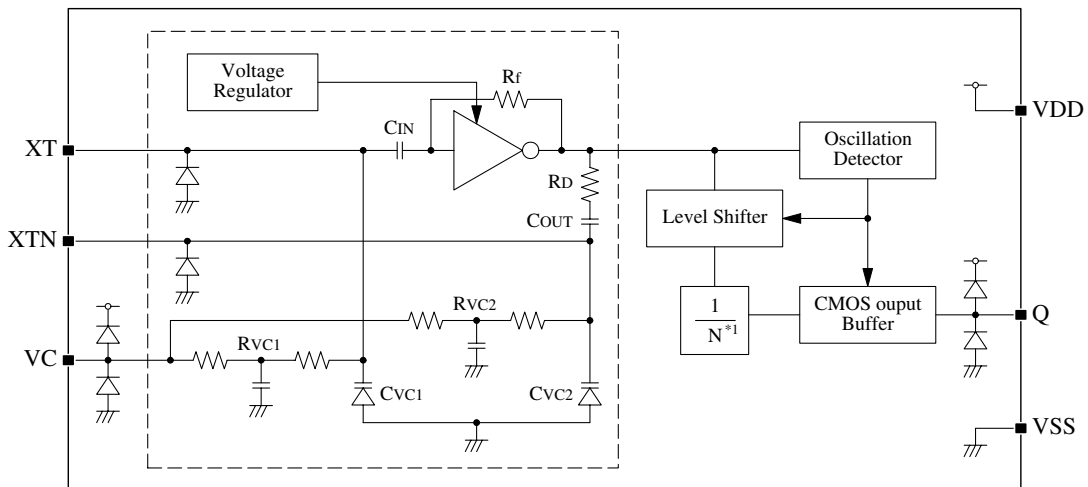

\*1. N = 1, 2, 4, 8, 16

**ABSOLUTE MAXIMUM RATINGS**

$V_{SS} = 0V$

Parameter	Symbol	Conditions	Rating	Unit
Supply voltage range	$V_{DD}$	Between VDD and VSS	-0.5 to 7.0	V
Input voltage range	$V_{IN}$	Input pins	-0.5 to $V_{DD} + 0.5$	V
Output voltage range	$V_{OUT}$	Output pins	-0.5 to $V_{DD} + 0.5$	V
Storage temperature range	$T_{STG}$	Wafer form, chip form	-65 to +150	°C
Output current	$I_{OUT}$	Q pin	20	mA

**RECOMMENDED OPERATING CONDITIONS**

$V_{SS} = 0V$

Parameter	Symbol	Conditions	Rating			Unit	
			Min	Typ	Max		
Operating supply voltage	$V_{DD}$	$C_{LOUT} \leq 15pF$	1.6	-	2.0	V	
Input voltage	$V_{IN}$	Input pins	$V_{SS}$	-	$V_{DD}$	V	
Operating temperature	$T_{OPR}$		-40	-	+85	°C	
Oscillation frequency <sup>*1</sup>	$f_O$	5076×1 to 5076×5	20	-	40	MHz	
		5076×J to 5076×N	40	-	55	MHz	
Output frequency	$f_{OUT}$	$C_{LOUT} \leq 15pF$	5076×1 to 5076×5	1.25	-	40	MHz
			5076×J to 5076×N	2.5	-	55	MHz

\*1. The oscillation frequency is a yardstick value derived from the crystal used for NPC characteristics authentication. However, the oscillation frequency range is not guaranteed. Specifically, the characteristics can vary greatly due to crystal characteristics and mounting conditions, so the oscillation characteristics of components must be carefully evaluated.

## ELECTRICAL CHARACTERISTICS

## 5076×1 to 5076×5

$V_{DD} = 1.6$  to  $2.0V$ ,  $V_C = 0.5V_{DD}$ ,  $V_{SS} = 0V$ ,  $T_a = -40$  to  $+85^\circ C$  unless otherwise noted.

Parameter	Symbol	Conditions	Rating			Unit	
			Min	Typ	Max		
Current consumption	$I_{DD}$	5076×1 ( $f_O$ ), Measurement circuit 1, no load, $f_O = 27MHz$ , $f_{OUT} = 27MHz$ , $V_{DD} = 1.8V$	–	0.5	1.0	mA	
		5076×2 ( $f_O/2$ ), Measurement circuit 1, no load, $f_O = 27MHz$ , $f_{OUT} = 13.5MHz$ , $V_{DD} = 1.8V$	–	0.4	0.8	mA	
		5076×3 ( $f_O/4$ ), Measurement circuit 1, no load, $f_O = 27MHz$ , $f_{OUT} = 6.75MHz$ , $V_{DD} = 1.8V$	–	0.3	0.6	mA	
		5076×4 ( $f_O/8$ ), Measurement circuit 1, no load, $f_O = 27MHz$ , $f_{OUT} = 3.38MHz$ , $V_{DD} = 1.8V$	–	0.3	0.6	mA	
		5076×5 ( $f_O/16$ ), Measurement circuit 1, no load, $f_O = 27MHz$ , $f_{OUT} = 1.69MHz$ , $V_{DD} = 1.8V$	–	0.3	0.6	mA	
HIGH-level output voltage	$V_{OH}$	Q pin, Measurement circuit 2, $I_{OH} = -2.0mA$	$V_{DD} - 0.4$	–	–	V	
LOW-level output voltage	$V_{OL}$	Q pin, Measurement circuit 2, $I_{OL} = 2.0mA$	–	–	0.4	V	
Oscillator block built-in resistance	$R_{VC1}$	Measurement circuit 3	210	420	840	k $\Omega$	
	$R_{VC2}$		210	420	840	k $\Omega$	
Oscillator block built-in capacitance	$C_{VC1}$	Design value (a monitor pattern on a wafer is tested), Excluding parasitic capacitance.	$V_C = 0.2V$	–	4.7	–	pF
			$V_C = 0.9V$	–	2.9	–	pF
			$V_C = 1.6V$	–	1.7	–	pF
	$C_{VC2}$		$V_C = 0.2V$	–	4.7	–	pF
			$V_C = 0.9V$	–	2.9	–	pF
			$V_C = 1.6V$	–	1.7	–	pF
VC input resistance	$R_{VIN}$	Measurement circuit 4, $T_a = 25^\circ C$	10	–	–	M $\Omega$	
VC input impedance	$Z_{VIN}$	Measurement circuit 5, $V_C = 0V$ , $f = 10kHz$ , $T_a = 25^\circ C$ (a monitor pattern on a wafer is tested)	–	530	–	k $\Omega$	
VC input capacitance	$C_{VIN}$	Measurement circuit 5, $V_C = 0V$ , $f = 10kHz$ , $T_a = 25^\circ C$ (a monitor pattern on a wafer is tested)	–	31	–	pF	
Modulation characteristics*1	fm	Measurement circuit 6, –3dB frequency, $V_{DD} = 1.8V$ , $V_C = 1.8Vp-p$ , $T_a = 25^\circ C$ , $f_O = 27MHz$	–	100	–	kHz	

\*1. The modulation characteristics may vary with the crystal used.

## 5076 series

### 5076×J to 5076×N

$V_{DD} = 1.6$  to  $2.0V$ ,  $V_C = 0.5V_{DD}$ ,  $V_{SS} = 0V$ ,  $T_a = -40$  to  $+85^{\circ}C$  unless otherwise noted.

Parameter	Symbol	Conditions	Rating			Unit	
			Min	Typ	Max		
Current consumption	$I_{DD}$	5076×J ( $f_O$ ), Measurement circuit 1, no load, $f_O = 48MHz$ , $f_{OUT} = 48MHz$ , $V_{DD} = 1.8V$	–	0.9	1.8	mA	
		5076×K ( $f_O/2$ ), Measurement circuit 1, no load, $f_O = 48MHz$ , $f_{OUT} = 24MHz$ , $V_{DD} = 1.8V$	–	0.6	1.2	mA	
		5076×L ( $f_O/4$ ), Measurement circuit 1, no load, $f_O = 48MHz$ , $f_{OUT} = 12MHz$ , $V_{DD} = 1.8V$	–	0.5	1.0	mA	
		5076×M ( $f_O/8$ ), Measurement circuit 1, no load, $f_O = 48MHz$ , $f_{OUT} = 6MHz$ , $V_{DD} = 1.8V$	–	0.4	0.8	mA	
		5076×N ( $f_O/16$ ), Measurement circuit 1, no load, $f_O = 48MHz$ , $f_{OUT} = 3MHz$ , $V_{DD} = 1.8V$	–	0.4	0.8	mA	
HIGH-level output voltage	$V_{OH}$	Q pin, Measurement circuit 2, $I_{OH} = -2.0mA$	$V_{DD} - 0.4$	–	–	V	
LOW-level output voltage	$V_{OL}$	Q pin, Measurement circuit 2, $I_{OL} = 2.0mA$	–	–	0.4	V	
Oscillator block built-in resistance	$R_{VC1}$	Measurement circuit 3	210	420	840	k $\Omega$	
	$R_{VC2}$		210	420	840	k $\Omega$	
Oscillator block built-in capacitance	$C_{VC1}$	Design value (a monitor pattern on a wafer is tested), Excluding parasitic capacitance.	$V_C = 0.2V$	–	4.7	–	pF
			$V_C = 0.9V$	–	2.9	–	pF
			$V_C = 1.6V$	–	1.7	–	pF
	$C_{VC2}$		$V_C = 0.2V$	–	4.7	–	pF
			$V_C = 0.9V$	–	2.9	–	pF
			$V_C = 1.6V$	–	1.7	–	pF
VC input resistance	$R_{VIN}$	Measurement circuit 4, $T_a = 25^{\circ}C$	10	–	–	M $\Omega$	
VC input impedance	$Z_{VIN}$	Measurement circuit 5, $V_C = 0V$ , $f = 10kHz$ , $T_a = 25^{\circ}C$ (a monitor pattern on a wafer is tested)	–	530	–	k $\Omega$	
VC input capacitance	$C_{VIN}$	Measurement circuit 5, $V_C = 0V$ , $f = 10kHz$ , $T_a = 25^{\circ}C$ (a monitor pattern on a wafer is tested)	–	31	–	pF	
Modulation characteristics*1	$f_m$	Measurement circuit 6, –3dB frequency, $V_{DD} = 1.8V$ , $V_C = 1.8V_{p-p}$ , $T_a = 25^{\circ}C$ , $f_O = 48MHz$	–	35	–	kHz	

\*1. The modulation characteristics may vary with the crystal used.

## SWITCHING CHARACTERISTICS

$V_{DD} = 1.6$  to  $2.0V$ ,  $V_C = 0.5V_{DD}$ ,  $V_{SS} = 0V$ ,  $T_a = -40$  to  $+85^\circ C$  unless otherwise noted.

Parameter	Symbol	Conditions	Rating			Unit
			Min	Typ	Max	
Output rise time	$t_r$	Measurement circuit 7, $0.2V_{DD} \rightarrow 0.8V_{DD}$ , $C_{LOUT} = 15pF$	–	3.1	6.0	ns
Output fall time	$t_f$	Measurement circuit 7, $0.8V_{DD} \rightarrow 0.2V_{DD}$ , $C_{LOUT} = 15pF$	–	3.1	6.0	ns
Output duty cycle	Duty	Measurement circuit 7, $T_a = 25^\circ C$ , $C_{LOUT} = 15pF$ , $V_{DD} = 1.8V$	45	50	55	%

### Switching Time Measurement Waveform

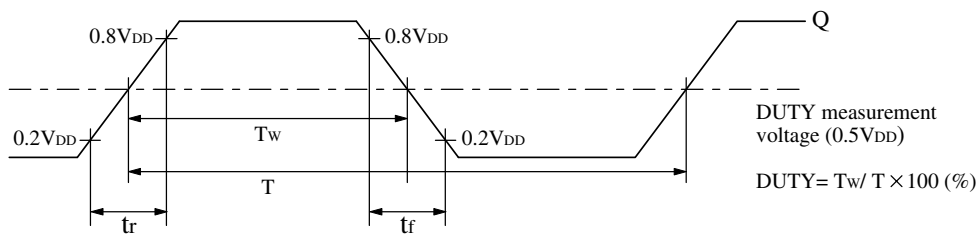

## MEASUREMENT CIRCUITS

### Measurement Circuit 1

Measurement parameter:  $I_{DD}$

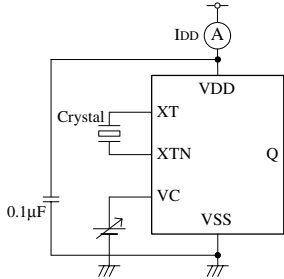

### Measurement Circuit 4

Measurement parameter:  $R_{VIN}$

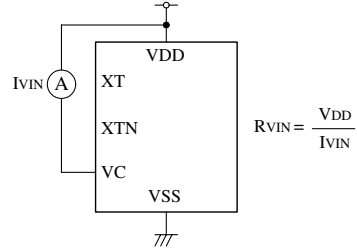

### Measurement Circuit 2

Measurement parameter:  $V_{OH}$ ,  $V_{OL}$

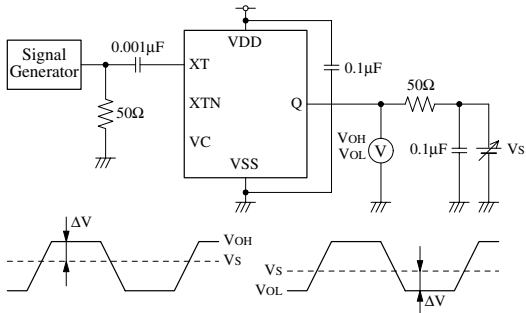

$V_S$  adjusted such that  $\Delta V = 50 \times I_{OH}$

$V_S$  adjusted such that  $\Delta V = 50 \times I_{OL}$

XT input signal: 1Vp-p, sine wave

### Measurement Circuit 5

Measurement parameter:  $C_{VIN}$ ,  $Z_{VIN}$

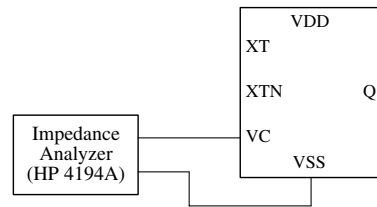

VC input signal: 100Hz to 10kHz, 0.1Vp-p

### Measurement Circuit 6

Measurement parameter:  $f_m$

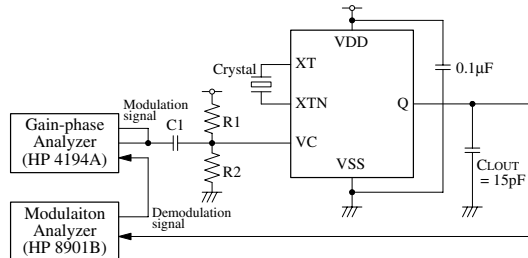

$C1 = 33\mu F$ ,  $R1 = R2 = 1M\Omega$

VC modulation signal: 100Hz to 100kHz, 0 to  $V_{DDP-p}$

### Measurement Circuit 3

Measurement parameter:  $R_{VC1}$ ,  $R_{VC2}$

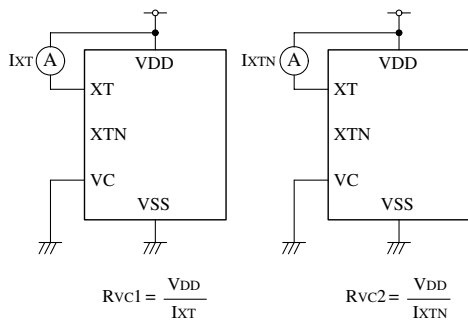

### Measurement Circuit 7

Measurement parameter: Duty,  $t_r$ ,  $t_f$

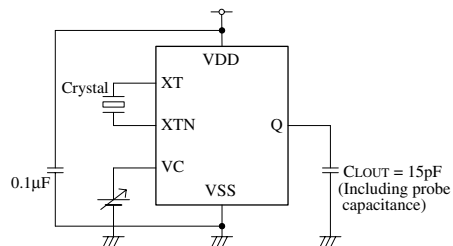



## FUNCTIONAL DESCRIPTION

### Oscillation Start-up Detector Function

The devices also feature an oscillation start-up detector circuit. This circuit functions to disable the outputs until the oscillation starts. This prevents unstable oscillator output at oscillator start-up when power is applied.

### TYPICAL PERFORMANCE (5076B1)

The following characteristics measured using the crystal below. Note that the characteristics will vary with the crystal used.

■ Crystal used for measurement

Parameter	$f_0 = 27\text{MHz}$
$C_0$ [pF]	1.5
$\gamma (= C_0/C_1)$	300

■ Crystal parameters

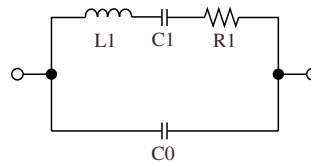

### Frequency Pulling Range

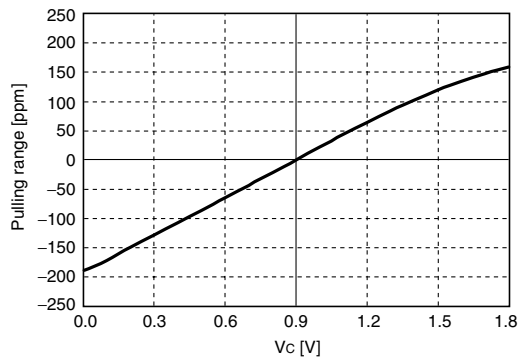

$V_{DD} = 1.8\text{V}$ ,  $f_{OUT} = 27\text{MHz}$ ,  $T_a = \text{R.T.}$

### Pulling Sensitivity

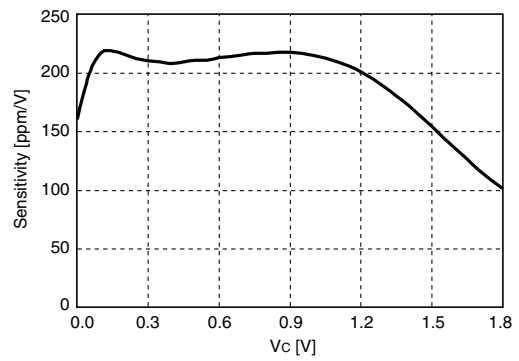

$V_{DD} = 1.8\text{V}$ ,  $f_{OUT} = 27\text{MHz}$ ,  $T_a = \text{R.T.}$

### Measurement circuit

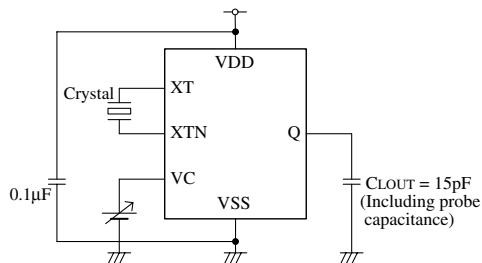

### Current Consumption

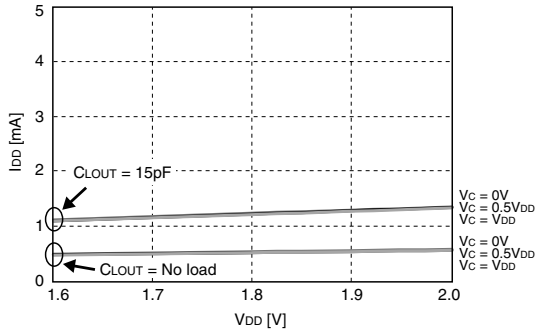

$f_{OUT} = 27\text{MHz}$ ,  $T_a = \text{R.T.}$

### Measurement circuit

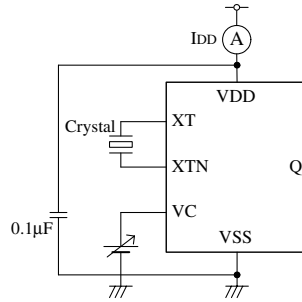

### Frequency Stability by Supply Voltage Change

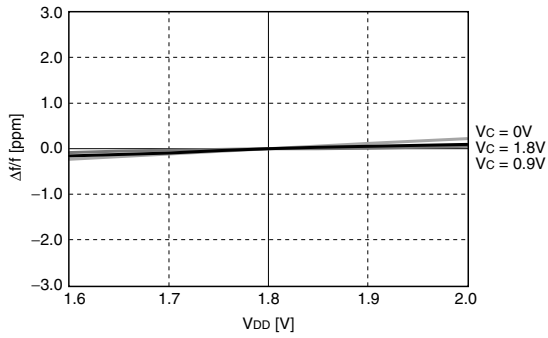

$f_{OUT} = 27\text{MHz}$ ,  $\pm 0\text{ppm}$  at  $V_{DD} = 1.8\text{V}$

### Measurement circuit

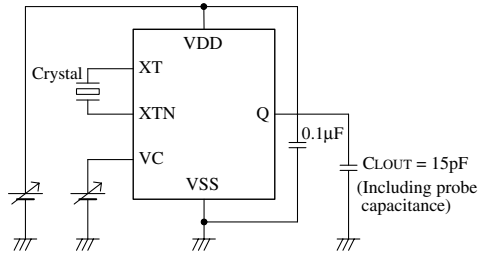

### Drive Level

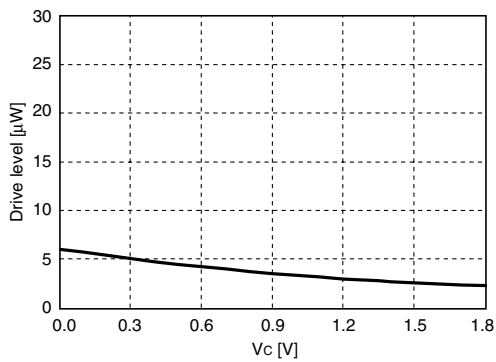

$V_{DD} = 1.8\text{V}$ ,  $f_{OUT} = 27\text{MHz}$ ,  $T_a = \text{R.T.}$

### Measurement circuit

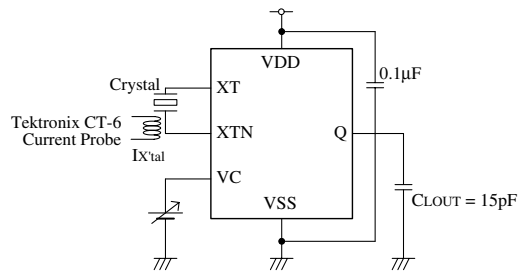

$DL = (I_{X'tal})^2 \times Re$   
 DL: drive level  
 $I_{X'tal}$ : current flowing to crystal (RMS value)  
 Re: crystal effective resistance

### Negative Resistance

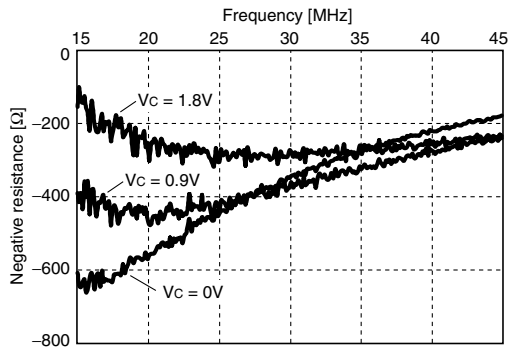

$V_{DD} = 1.8V, C_0 = 2pF, T_a = R.T.$

Note. "C0" value is set, concerning the actual crystal characteristics connected between XT and XTN. The data is measured with Agilent 4396B using NPC's original measurement jig. The values may vary with measurement jig and conditions.

### Measurement circuit

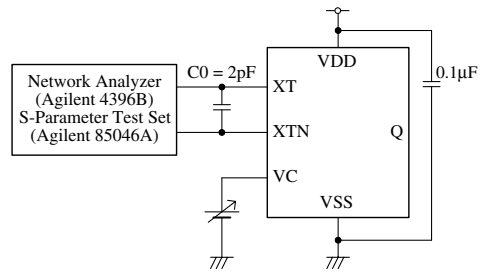

### Phase Noise

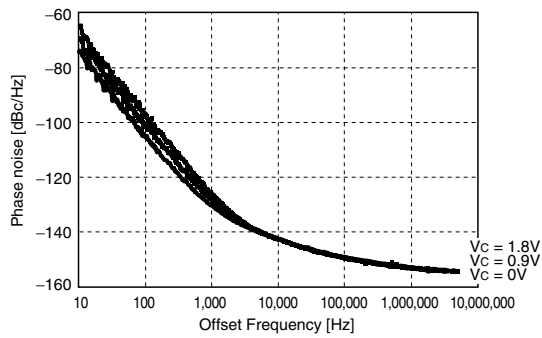

$V_{DD} = 1.8V, f_{OUT} = 27MHz, T_a = R.T.$

### Measurement circuit

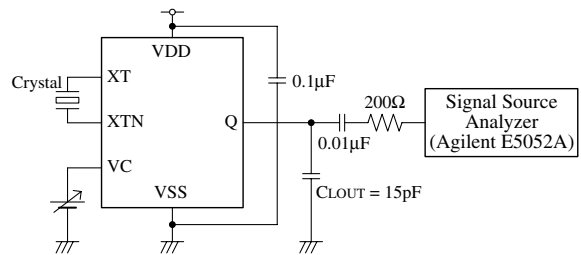

### Modulation Characteristics

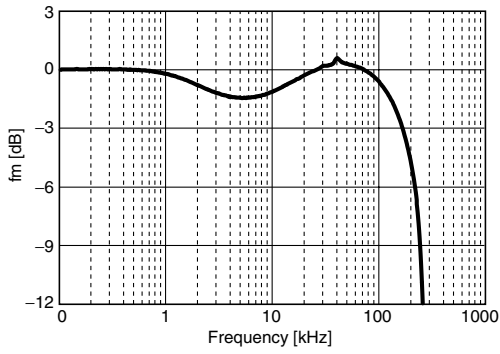

$V_{DD} = 1.8V, f_{OUT} = 27MHz, T_a = R.T.$

### Measurement circuit

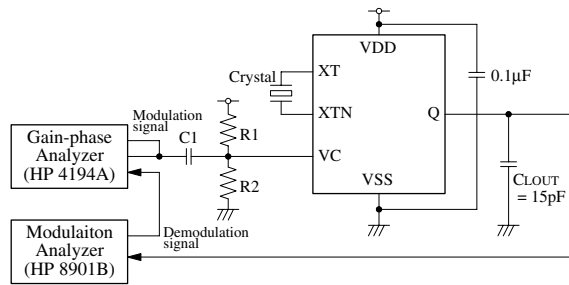

$C_1 = 33\mu F, R_1 = R_2 = 1M\Omega$   
 VC modulation signal: 100Hz to 100kHz, 0 to  $V_{DDp-p}$

### Output Waveform

Measurement equipment: Oscilloscope; DSO80604B (Agilent)

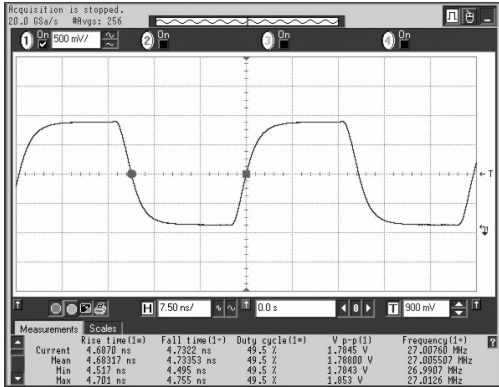

$V_{DD} = 1.8V, f_{OUT} = 27MHz, V_C = 0.5V_{DD},$   
 $C_{LOUT} = 15pF, T_a = R.T.$

### Measurement circuit

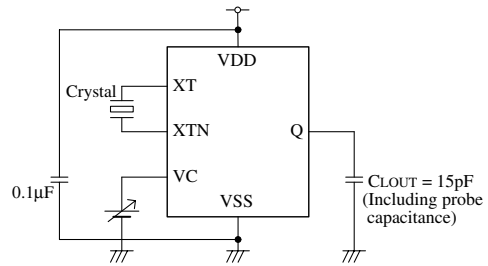

Please pay your attention to the following points at time of using the products shown in this document.

The products shown in this document (hereinafter "Products") are not intended to be used for the apparatus that exerts harmful influence on human lives due to the defects, failure or malfunction of the Products. Customers are requested to obtain prior written agreement for such use from SEIKO NPC CORPORATION (hereinafter "NPC"). Customers shall be solely responsible for, and indemnify and hold NPC free and harmless from, any and all claims, damages, losses, expenses or lawsuits, due to such use without such agreement. NPC reserves the right to change the specifications of the Products in order to improve the characteristic or reliability thereof. NPC makes no claim or warranty that the contents described in this document dose not infringe any intellectual property right or other similar right owned by third parties. Therefore, NPC shall not be responsible for such problems, even if the use is in accordance with the descriptions provided in this document. Any descriptions including applications, circuits, and the parameters of the Products in this document are for reference to use the Products, and shall not be guaranteed free from defect, inapplicability to the design for the mass-production products without further testing or modification. Customers are requested not to export or re-export, directly or indirectly, the Products to any country or any entity not in compliance with or in violation of the national export administration laws, treaties, orders and regulations. Customers are requested appropriately take steps to obtain required permissions or approvals from appropriate government agencies.

The logo for SEIKO NPC CORPORATION, consisting of the letters 'NPC' in a bold, black, sans-serif font.

**SEIKO NPC CORPORATION**

15-6, Nihombashi-kabutocho, Chuo-ku,  
Tokyo 103-0026, Japan  
Telephone: +81-3-6667-6601  
Facsimile: +81-3-6667-6611  
<http://www.npc.co.jp/>  
Email: [sales@npc.co.jp](mailto:sales@npc.co.jp)

NC0811AE 2009.02