

N-Channel MOSFET

Features

- $R_{DS(on)}$ (Max 1.4 Ω) @ $V_{GS}=10V$
- Gate Charge (Typical 25nC)
- Improved dv/dt Capability, High Ruggedness
- 100% Avalanche Tested
- Maximum Junction Temperature Range (150°C)

General Description

This Power MOSFET is produced using Wisdom's advanced planar stripe, DMOS technology. This latest technology has been especially designed to minimize on-state resistance, have a high rugged avalanche characteristics. These devices are well suited for high efficiency switching DC/DC converters, switch mode power supply, DC-AC converters for uninterrupted power supply, motor control.

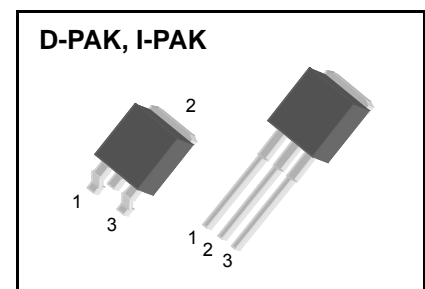
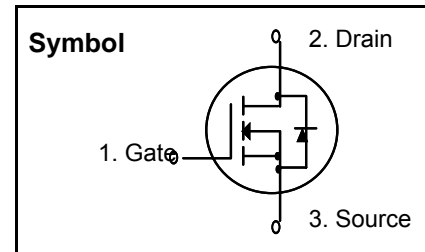

Absolute Maximum Ratings

Symbol	Parameter	Value	Units
V_{DSS}	Drain to Source Voltage	500	V
I_D	Continuous Drain Current(@ $T_C = 25^\circ C$)	4.0	A
	Continuous Drain Current(@ $T_C = 100^\circ C$)	2.4	A
I_{DM}	Drain Current Pulsed (Note 1)	16	A
V_{GS}	Gate to Source Voltage	± 30	V
E_{AS}	Single Pulsed Avalanche Energy (Note 2)	292	mJ
E_{AR}	Repetitive Avalanche Energy (Note 1)	4.8	mJ
dv/dt	Peak Diode Recovery dv/dt (Note 3)	5.5	V/ns
P_D	Total Power Dissipation(@ $T_C = 25^\circ C$)	48	W
	Derating Factor above 25 °C	0.38	W/°C
T_{STG}, T_J	Operating Junction Temperature & Storage Temperature	- 55 ~ 150	°C
T_L	Maximum Lead Temperature for soldering purpose, 1/8 from Case for 5 seconds.	300	°C

Thermal Characteristics

Symbol	Parameter	Value			Units
		Min.	Typ.	Max.	
$R_{\theta JC}$	Thermal Resistance, Junction-to-Case	-	-	2.6	°C/W
$R_{\theta JA}$	Thermal Resistance, Junction-to-Ambient *	-	-	50	°C/W
$R_{\theta JA}$	Thermal Resistance, Junction-to-Ambient	-	-	110	°C/W

* When mounted on the minimum pad size recommended (PCB Mount)

Electrical Characteristics $T_C = 25^\circ\text{C}$ unless otherwise noted

Symbol	Parameter	Test Conditions	Min	Typ	Max	Units
Off Characteristics						
BV_{DSS}	Drain-Source Breakdown Voltage	$V_{GS} = 0\text{ V}, I_D = 250\ \mu\text{A}$	500	--	--	V
$\Delta BV_{DSS} / \Delta T_J$	Breakdown Voltage Temperature Coefficient	$I_D = 250\ \mu\text{A}$, Referenced to 25°C	--	0.50	--	$\text{V}/^\circ\text{C}$
I_{DSS}	Zero Gate Voltage Drain Current	$V_{DS} = 500\text{ V}, V_{GS} = 0\text{ V}$	--	--	10	μA
		$V_{DS} = 400\text{ V}, T_C = 125^\circ\text{C}$	--	--	100	μA
I_{GSSF}	Gate-Body Leakage Current, Forward	$V_{GS} = 30\text{ V}, V_{DS} = 0\text{ V}$	--	--	100	nA
I_{GSSR}	Gate-Body Leakage Current, Reverse	$V_{GS} = -30\text{ V}, V_{DS} = 0\text{ V}$	--	--	-100	nA

On Characteristics

$V_{GS(th)}$	Gate Threshold Voltage	$V_{DS} = V_{GS}, I_D = 250\ \mu\text{A}$	2.0	--	4.0	V
$R_{DS(on)}$	Static Drain-Source On-Resistance	$V_{GS} = 10\text{ V}, I_D = 2.0\text{ A}$	--	1.15	1.40	Ω

(Note 4)

Dynamic Characteristics

C_{iss}	Input Capacitance	$V_{DS} = 25\text{ V}, V_{GS} = 0\text{ V},$ $f = 1.0\text{ MHz}$	--	680	900	pF
C_{oss}	Output Capacitance		--	85	110	pF
C_{rss}	Reverse Transfer Capacitance		--	15	20	pF

Switching Characteristics

$t_{d(on)}$	Turn-On Delay Time	$V_{DD} = 250\text{ V}, I_D = 5.0\text{ A},$ $R_G = 25\ \Omega$	--	20	50	ns
t_r	Turn-On Rise Time		--	40	90	ns
$t_{d(off)}$	Turn-Off Delay Time		--	90	190	ns
t_f	Turn-Off Fall Time		--	45	100	ns
Q_g	Total Gate Charge		$V_{DS} = 400\text{ V}, I_D = 5.0\text{ A},$ $V_{GS} = 10\text{ V}$	--	25	33
Q_{gs}	Gate-Source Charge	--		5	--	nC
Q_{gd}	Gate-Drain Charge	--		10	--	nC

(Note 4, 5)

Drain-Source Diode Characteristics and Maximum Ratings

I_S	Maximum Continuous Drain-Source Diode Forward Current	--	--	4.0	A	
I_{SM}	Maximum Pulsed Drain-Source Diode Forward Current	--	--	16	A	
V_{SD}	Drain-Source Diode Forward Voltage	$V_{GS} = 0\text{ V}, I_S = 4.0\text{ A}$	--	--	1.5	V
t_{rr}	Reverse Recovery Time	$V_{GS} = 0\text{ V}, I_S = 5.0\text{ A},$ $di_F / dt = 100\text{ A}/\mu\text{s}$	--	250	--	ns
Q_{rr}	Reverse Recovery Charge		--	2.2	--	μC

(Note 4)

Notes:

1. Repetitive Rating : Pulse width limited by maximum junction temperature
2. $L = 21.0\text{ mH}, I_{AS} = 5.0\text{ A}, V_{DD} = 50\text{ V}, R_G = 25\ \Omega$, Starting $T_J = 25^\circ\text{C}$
3. $I_{SD} \leq 5.0\text{ A}, di/dt \leq 300\ \mu\text{A}/\text{s}, V_{DD} \leq BV_{DSS}$, Starting $T_J = 25^\circ\text{C}$
4. Pulse Test : Pulse width $\leq 300\ \mu\text{s}$, Duty cycle $\leq 2\%$
5. Essentially independent of operating temperature

Typical Characteristics

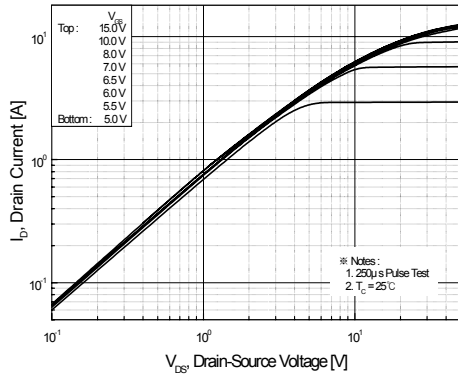

Figure 1. On-Region Characteristics

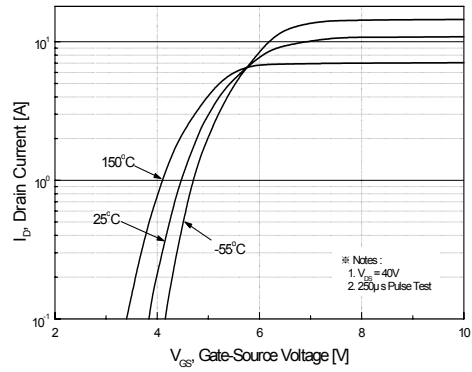

Figure 2. Transfer Characteristics

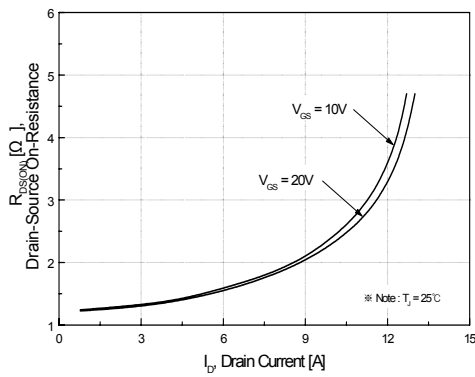

Figure 3. On-Resistance Variation vs Drain Current and Gate Voltage

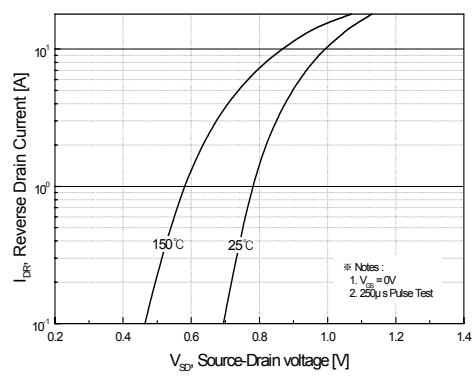

Figure 4. Body Diode Forward Voltage Variation with Source Current

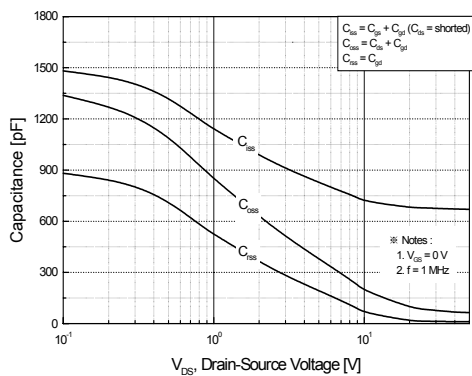

Figure 5. Capacitance Characteristics

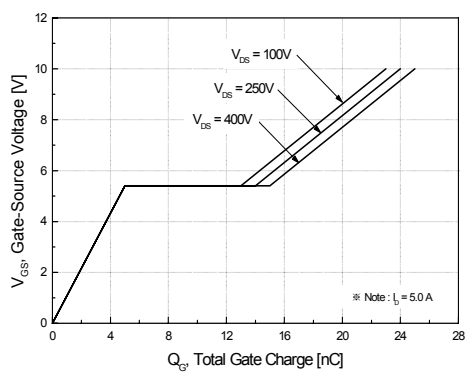

Figure 6. Gate Charge Characteristics

Typical Characteristics (Continued)

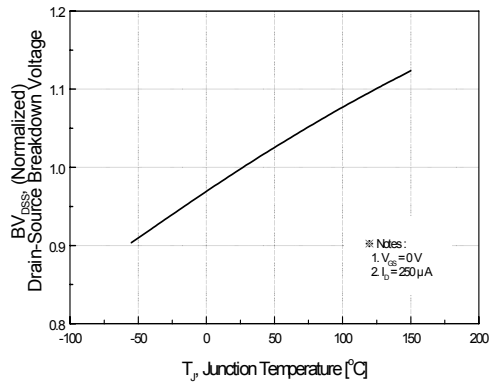

Figure 7. Breakdown Voltage Variation

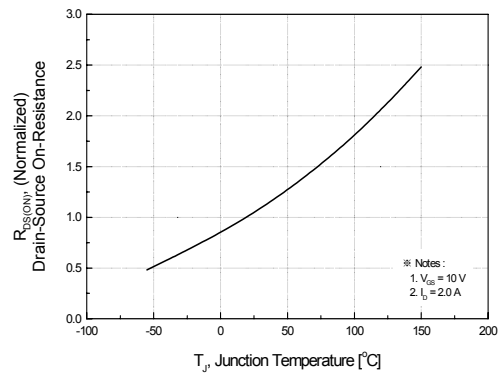

Figure 8. On-Resistance Variation vs Temperature

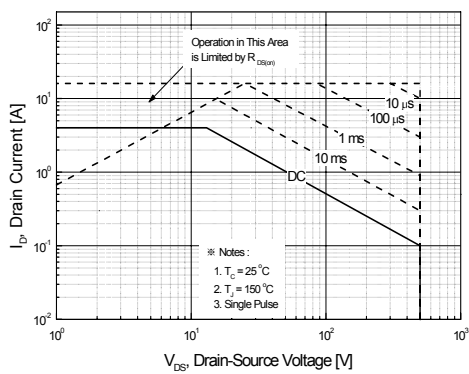

Figure 9. Maximum Safe Operating Area

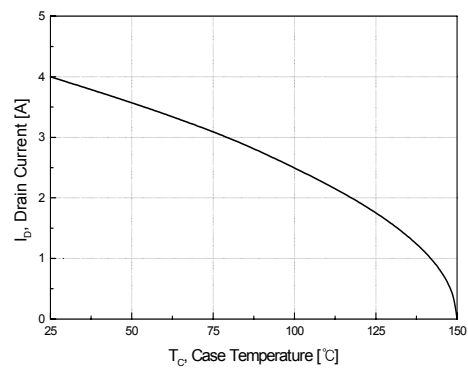

Figure 10. Maximum Drain Current vs Case Temperature

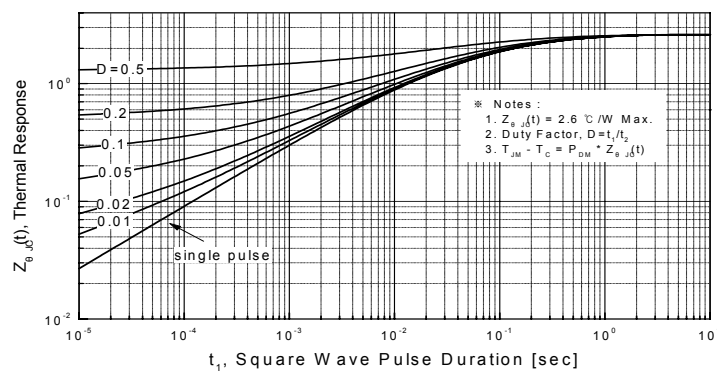
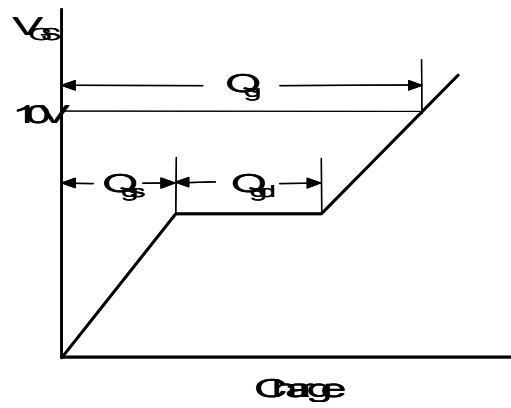
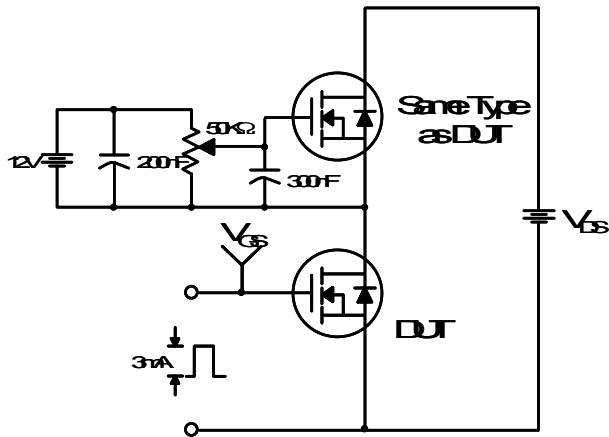
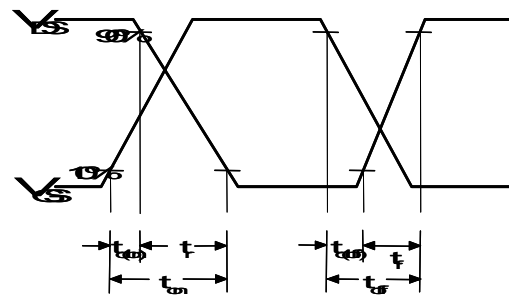
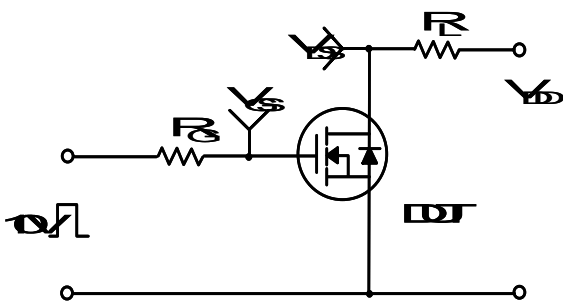

Figure 11. Transient Thermal Response Curve

Gate Charge Test Circuit & Waveform



Resistive Switching Test Circuit & Waveforms



www.DataSheet4U.com

Unclamped Inductive Switching Test Circuit & Waveforms

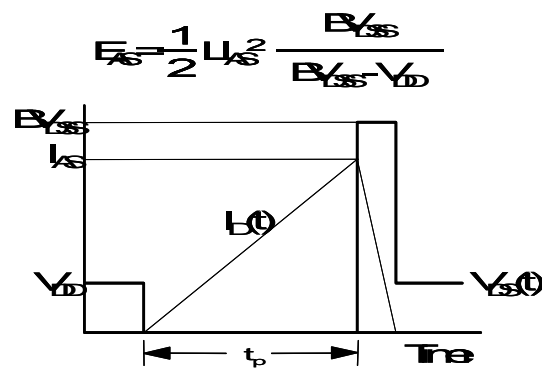
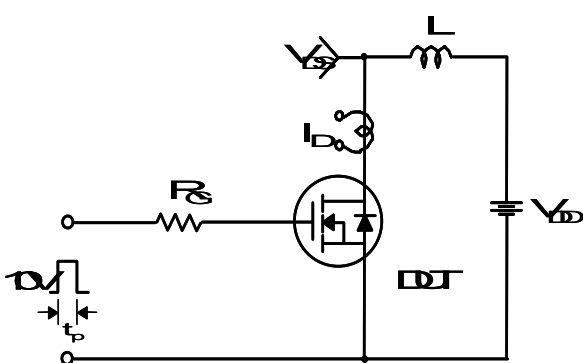

Peak Diode Recovery dv/dt Test Circuit & Waveforms

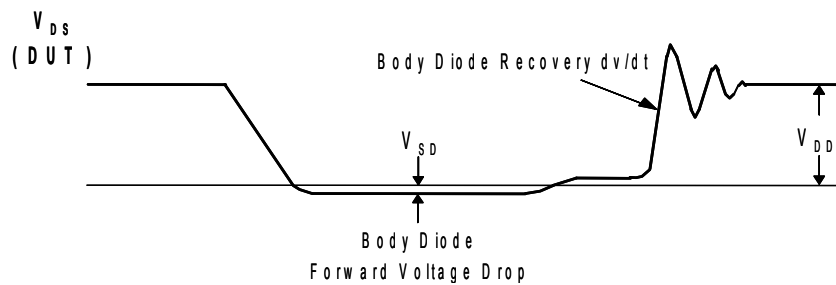
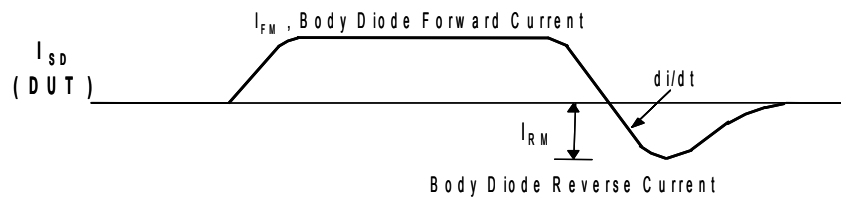
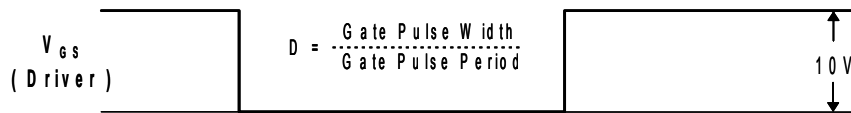
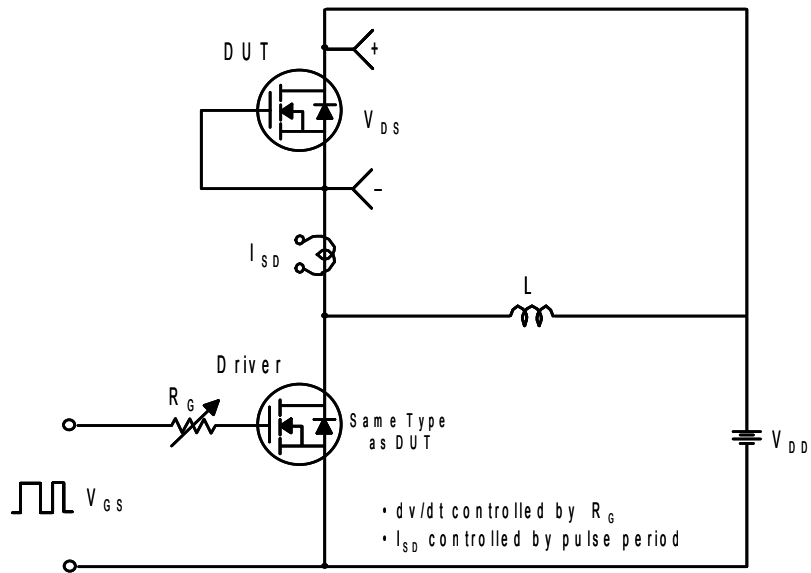

Package Dimensions

DPAK

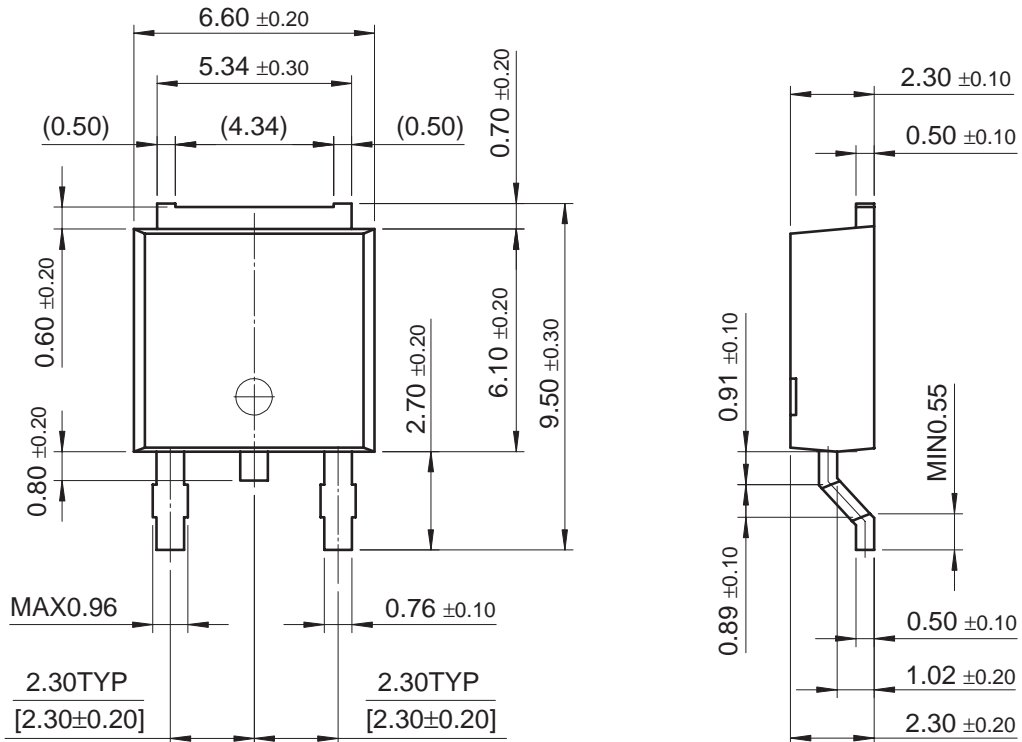

www.DataSheet4U.com

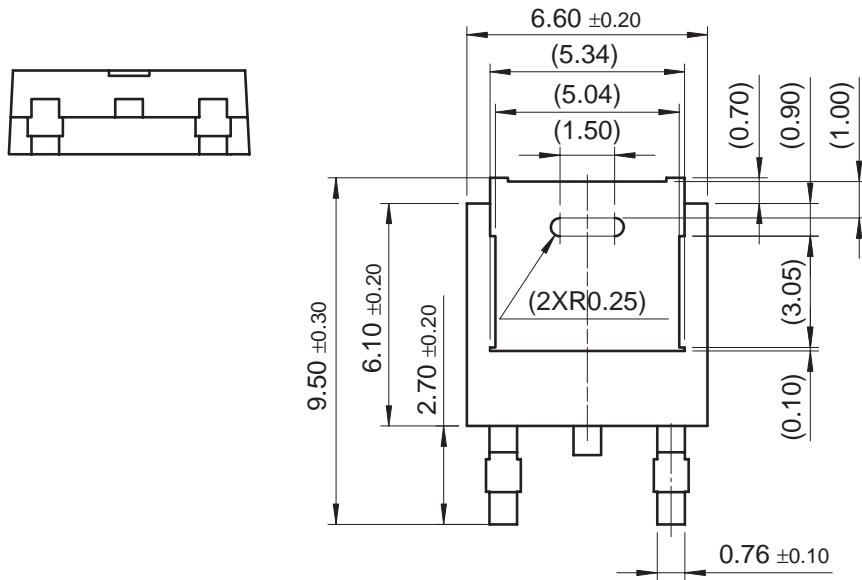

Package Dimensions (Continued)

IPAK

