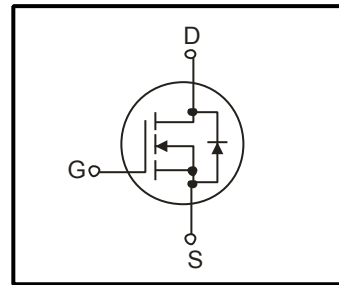
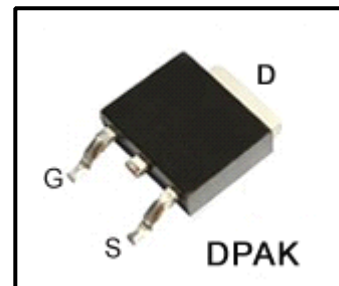

650V Super-Junction Power MOSFET
Features

- Ultra low R_{dson}
- Ultra low gate charge (typ. $Q_g = 19nC$)
- 100% UIS tested
- RoHS compliant

General Description

Power MOSFET is fabricated using advanced super junction technology. The resulting device has extremely low on resistance, making it especially suitable for applications which require superior power density and outstanding efficiency.

Absolute Maximum Ratings

Symbol	Parameter	Value	Units
V_{DSS}	Drain Source Voltage	650	V
I_D	Continuous Drain Current ($T_c=25^\circ C$) ($T_c=100^\circ C$)	7	A
		4.4	
I_{DM}	Drain Current Pulsed ¹⁾	21	A
V_{GS}	Gate to Source Voltage	± 30	V
E_{AS}	Single Pulse Avalanche Energy ²⁾	230	mJ
I_{AR}	Single Pulse Avalanche Current ¹⁾	7	A
E_{AR}	Repetitive Avalanche Energy ¹⁾	0.5	mJ
P_D	Total Power Dissipation (@ $T_c=25^\circ C$) -Derate above $25^\circ C$	83	W
		0.67	W/ $^\circ C$
T_J	Junction Temperature	150	$^\circ C$
T_{stg}	Storage Temperature	-55~150	$^\circ C$
I_S	Continuous diode forward current	7	A
$I_{S,pulse}$	Diode pulse current	21	A

Notes:

1.Repetitive Rating:Pulse width limited by maximum Junction Temperature

2. $I_{AS}=2.5, V_{DD}=60V, R_G=25\Omega$, Starting $T_J=25^\circ C$

Thermal Characteristics

Symbol	Parameter	Value			Units
		Min	Typ	Max	
$R_{\theta JC}$	Thermal Resistance , Junction -to -Case	-	-	1.5	$^\circ C/W$
$R_{\theta JA}$	Thermal Resistance , Junction -to -Ambient	-	-	62	$^\circ C/W$

Electrical Characteristics(Tc=25°C unless otherwise noted)

Characteristics	Symbol	Test Condition	Min	Type	Max	Unit
Gate leakage current	I _{GSS}	V _{GS} =±30V,V _{DS} =0V	-	-	±100	nA
Drain cut -off current	I _{DSS}	V _{DS} =650,V _{GS} =0V, T _J =25°C	-	-	1	μA
		T _J =125°C	-	10	-	
Drain -source breakdown voltage	V _{(BR)DSS}	I _D =250μA,V _{GS} =0V	650	-	-	V
Gate threshold voltage	V _{GS(th)}	V _{DS} =V _{GS} ,I _D =250uA	2.5	3.5	4.5	V
Drain -source ON resistance	R _{DS(ON)}	V _{GS} =10V,I _D =3.5A T _J =25°C	-	0.51	0.57	Ω
		T _J =150°C	-	1.2	-	
Gate resistance	R _G	f=1MHz,open drain	-	0.4	-	Ω
Input capacitance	C _{iss}	V _{DS} =25V,	-	710		pF
Reverse transfer capacitance	C _{rss}	V _{GS} =0V,	-	6		
Output capacitance	C _{oss}	f=1MHz	-	470		
Turn-on delay time	t _{d(on)}	V _{DD} = 300V, I _D = 3.5A R _G = 12Ω, V _{GS} =10V	-	16	-	ns
Rise time	t _r		-	13	-	
Turn-off delay time	t _{d(off)}		-	35	-	
Fall time	t _f		-	7	-	
Gate to source charge	Q _{gs}	V _{DD} =480V,I _D =3.5A, V _{GS} =0 to 10 V	-	4	-	nC
Gate to drain charge	Q _{gd}		-	9	-	
Gate charge total	Q _g		-	19	-	
Gate plateau voltage	V _{plateau}		-	5.8	-	

Source-Drain Ratings and Characteristics(Ta=25°C)

Characteristics	Symbol	Test Condition	Min	Type	Max	Unit
Diode forward voltage	V _{SD}	V _{GS} =0 V, I _F =3.5A	-	-	1.2	V
Reverse recovery time	t _{rr}	V _R =50 V, I _F =7A, dI _F /dt=100 A/μs	-	290	-	ns
Reverse recovery charge	Q _{rr}		-	3.4	-	μc
Peak reverse recovery current	I _{rrm}		-	14	-	A

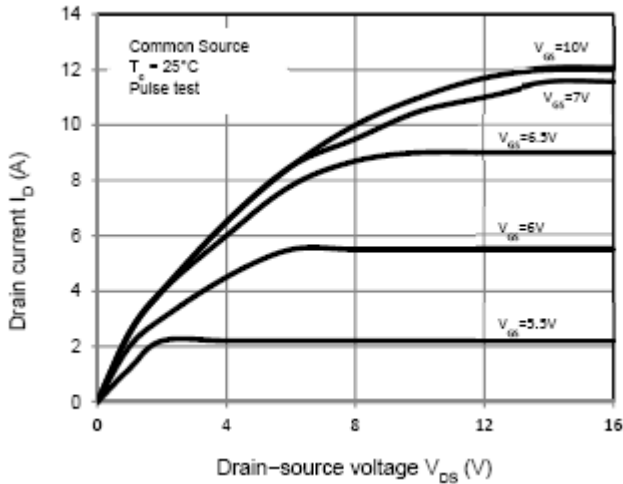

Fig.1 On-Region Characteristics

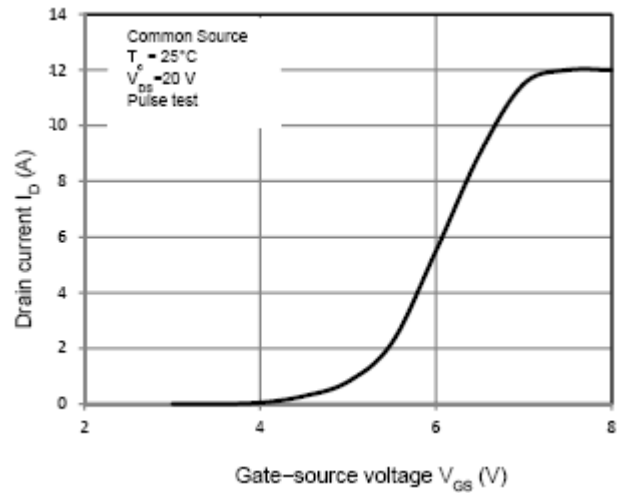

Fig.2 Transfer Characteristics

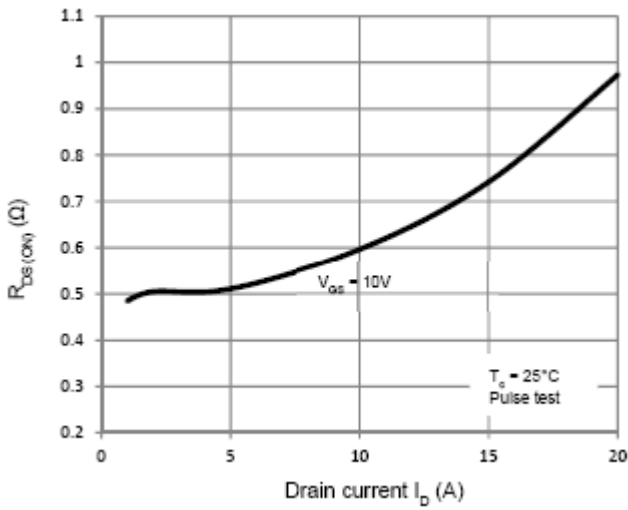

Fig.3 On-Resistance Variation vs. Drain Current

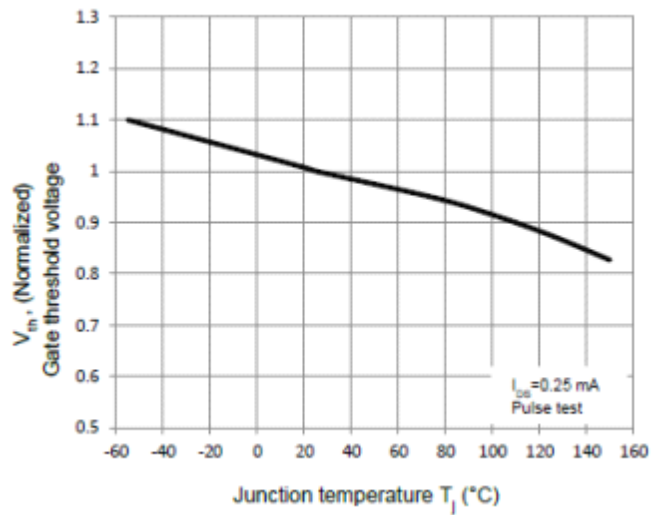

Fig.4 Threshold Voltage vs. Temperature

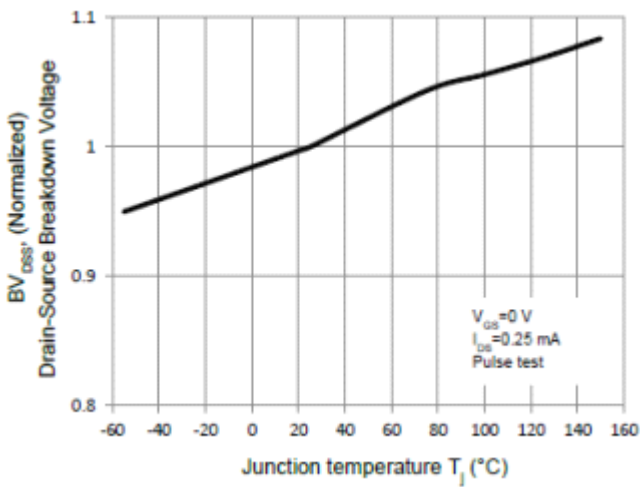

Fig.5 Breakdown Voltage vs. Temperature

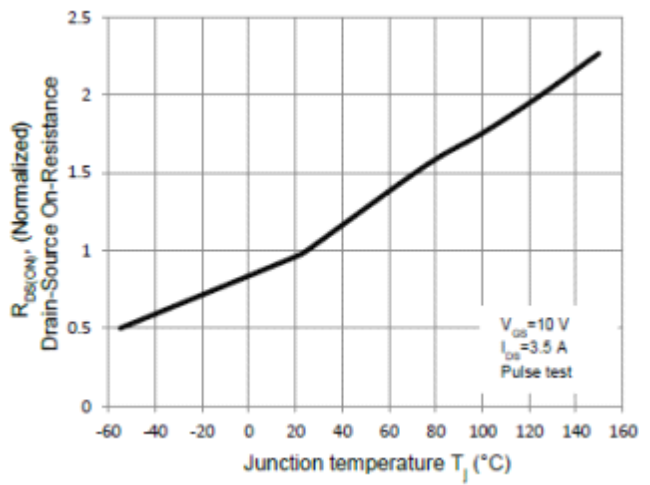

Fig.6 On-Resistance vs. Temperature

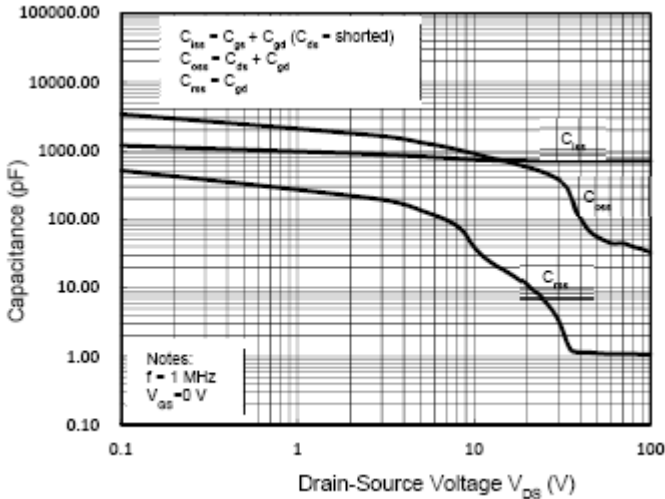

Fig.7 Capacitance Characteristics

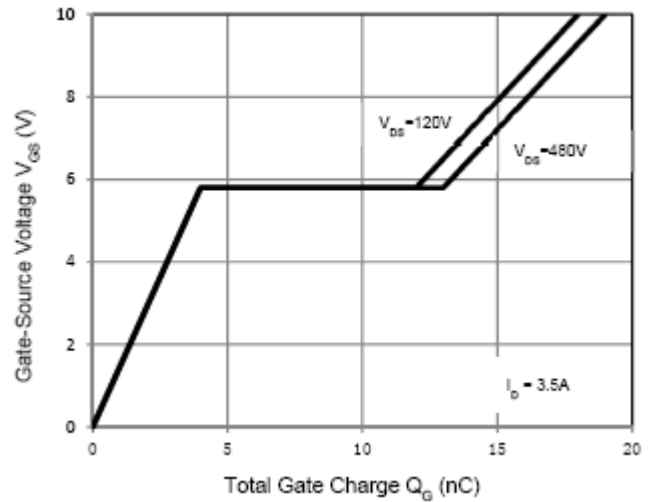

Fig.8 Gate Charge Characteristics

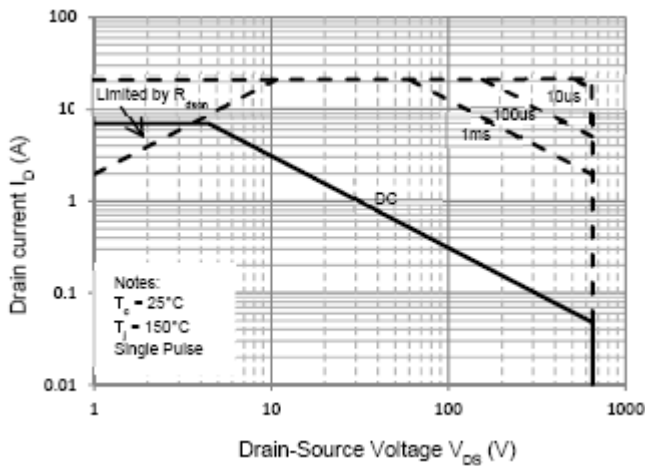

Fig.9 Maximum Safe Operating Area

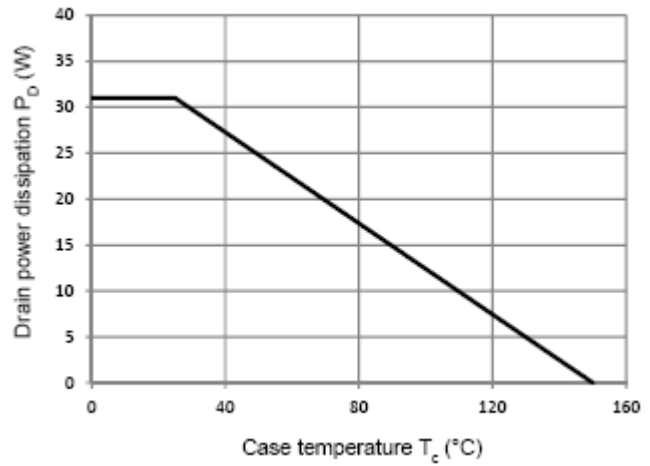

Fig.10 Power Dissipation vs. Temperature

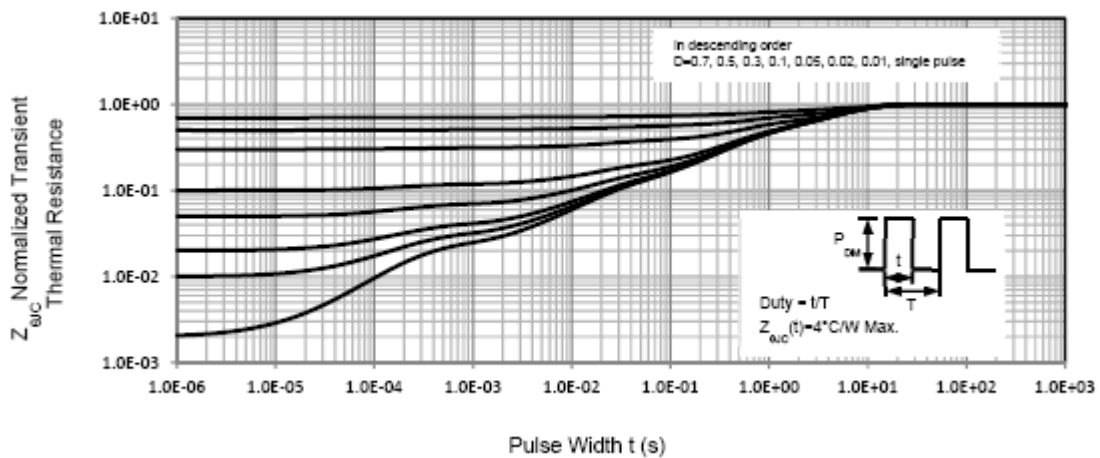

Fig.11 Transient Thermal Response Curve

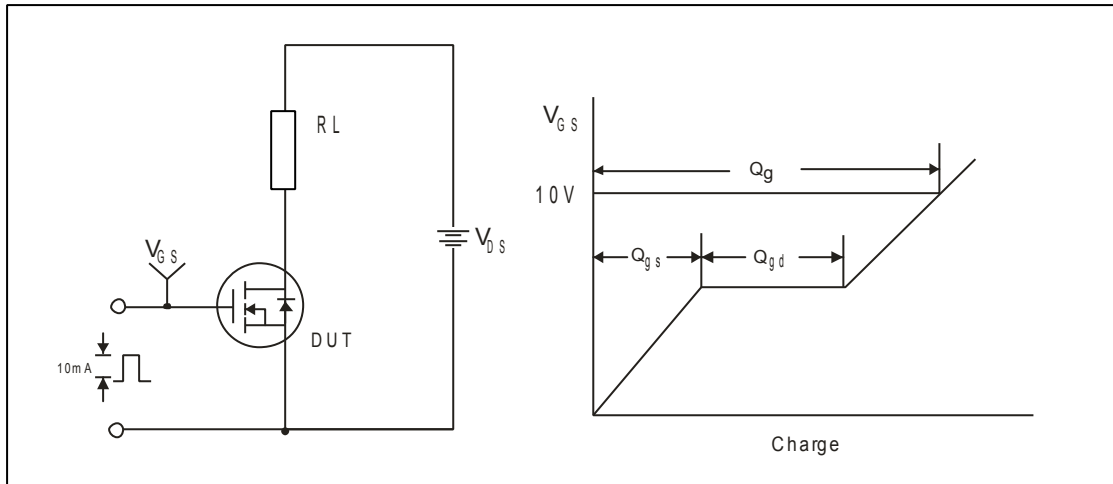

Fig.12 Gate Charge Test Circuit & Waveform

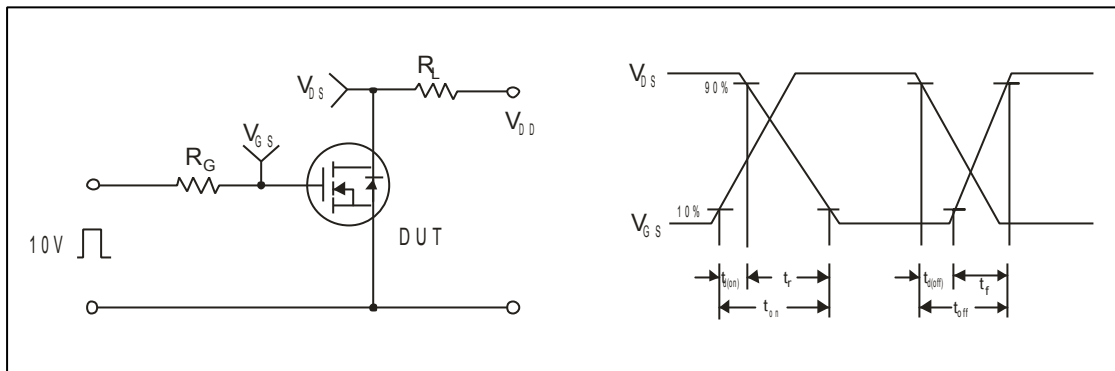

Fig.13 Switching Test Circuit & Waveforms

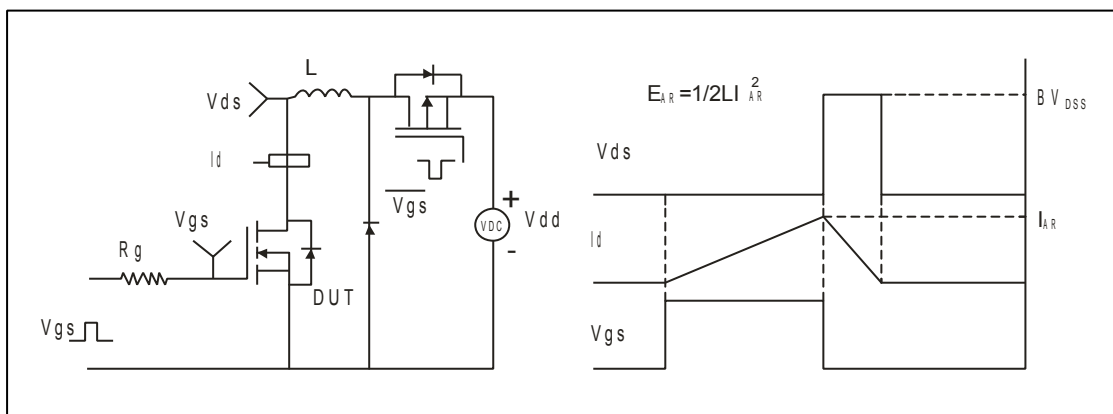
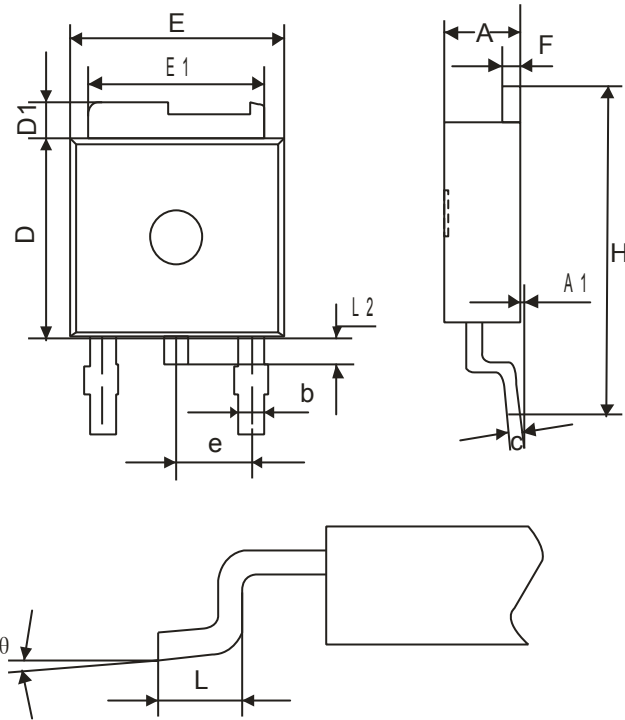

Fig.14 Unclamped Inductive Switching Test Circuit & Waveform

DPAK Package Dimension

Unit:mm



符号 symbol	MIN	MAX
A	2.19	2.38
A1	-	0.13
b	0.64	0.89
c	0.46	0.61
D	5.97	6.22
D1	0.89	1.27
E	6.35	6.73
E1	5.21	5.46
e	2.28TYP	
F	0.46	0.61
H	9.65	10.41
L	1.40	1.78
L2	0.64	1.01
θ	0°	8°