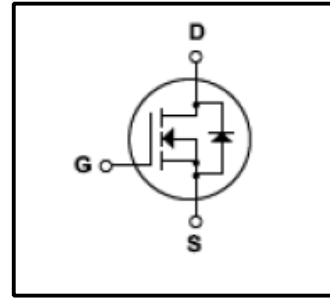
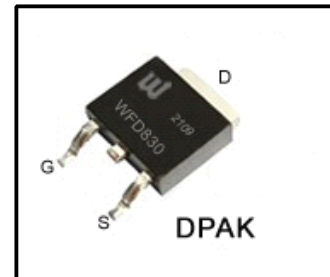

**Silicon N-Channel MOSFET**
**Features**

- 4.5A,500V, $R_{DS(on)}$ (Max 1.5 $\Omega$ )@ $V_{GS}=10V$
- Ultra-low Gate Charge(Typical 32nC)
- Fast Switching Capability
- 100%Avalanche Tested
- Maximum Junction Temperature Range(150 $^{\circ}C$ )

**General Description**

This Power MOSFET is produced using Winsemi's advanced planar stripe, DMOS technology. This latest technology has been especially designed to minimize on-state resistance, have a high rugged avalanche characteristics. This devices is specially well suited for high efficiency switch model power supplies, power factor correction and half bridge and full bridge resonant topology line a electronic lamp ballast.

**Absolute Maximum Ratings**

Symbol	Parameter	Value	Units
$V_{DSS}$	Drain Source Voltage	500	V
$I_D$	Continuous Drain Current(@ $T_c=25^{\circ}C$ )	4.5	A
	Continuous Drain Current(@ $T_c=100^{\circ}C$ )	2.9	A
$I_{DM}$	Drain Current Pulsed (Note1)	18	A
$V_{GS}$	Gate to Source Voltage	$\pm 30$	V
$E_{AS}$	Single Pulsed Avalanche Energy (Note 2)	300	mJ
$E_{AR}$	Repetitive Avalanche Energy (Note 1)	7.5	mJ
$dv/dt$	Peak Diode Recovery $dv/dt$ (Note 3)	4.5	V/ns
$P_D$	Total Power Dissipation(@ $T_c=25^{\circ}C$ )	48	W
	Derating Factor above 25 $^{\circ}C$	0.38	W/ $^{\circ}C$
$T_J, T_{stg}$	Junction and Storage Temperature	-55~150	$^{\circ}C$
$T_L$	Channel Temperature	300	$^{\circ}C$

**Thermal Characteristics**

Symbol	Parameter	Value			Units
		Min	Typ	Max	
$R_{QJC}$	Thermal Resistance, Junction-to-Case	-	-	2.6	$^{\circ}C/W$
$R_{QJA}$	Thermal Resistance, Junction-to-Ambient*	-	-	50	$^{\circ}C/W$
$R_{QJA}$	Thermal Resistance, Junction-to-Ambient	-	-	110	$^{\circ}C/W$

\*When mounted on the minimum pad size recommended(PCB Mount)

## Electrical Characteristics (Tc = 25° C)

Characteristics		Symbol	Test Condition	Min	Type	Max	Unit
Gate leakage current		I <sub>gss</sub>	V <sub>GS</sub> = ±30 V, V <sub>DS</sub> = 0 V	-	-	±100	nA
Gate-source breakdown voltage		V <sub>(BR)GSS</sub>	I <sub>G</sub> = ±10 μA, V <sub>DS</sub> = 0 V	±30	-	-	V
Drain cut-off current		I <sub>DSS</sub>	V <sub>DS</sub> = 500 V, V <sub>GS</sub> = 0 V	-	-	1	μA
Drain-source breakdown voltage		V <sub>(BR)DSS</sub>	I <sub>D</sub> = 250 μA, V <sub>GS</sub> = 0 V	500	-	-	V
Break Voltage Temperature Coefficient		ΔBV <sub>DSS</sub> /ΔT <sub>J</sub>	I <sub>D</sub> =250μA, Referenced to 25°C	-	0.55	-	V/°C
Gate threshold voltage		V <sub>GS(th)</sub>	V <sub>DS</sub> = 10 V, I <sub>D</sub> =250 μA	2	-	4	V
Drain-source ON resistance		R <sub>DS(ON)</sub>	V <sub>GS</sub> = 10 V, I <sub>D</sub> = 2.25A	-	1.16	1.5	Ω
Forward Transconductance		g <sub>fs</sub>	V <sub>DS</sub> = 40 V, I <sub>D</sub> = 2.25A	-	4.2	-	S
Input capacitance		C <sub>iss</sub>	V <sub>DS</sub> = 25 V,	-	800	1050	pF
Reverse transfer capacitance		C <sub>rss</sub>	V <sub>GS</sub> = 0 V,	-	18	23	
Output capacitance		C <sub>oss</sub>	f = 1 MHz	-	76	100	
Switching time	Rise time	t <sub>r</sub>	V <sub>DD</sub> =250 V, I <sub>D</sub> =4.5A R <sub>G</sub> =25Ω  (Note4,5)	-	15	40	ns
	Turn-on time	t <sub>on</sub>		-	40	90	
	Fall time	t <sub>f</sub>		-	85	180	
	Turn-off time	t <sub>off</sub>		-	45	100	
Total gate charge (gate-source plus gate-drain)		Q <sub>g</sub>	V <sub>DD</sub> = 400 V, V <sub>GS</sub> = 10 V, I <sub>D</sub> =4.5 A  (Note4,5)	-	32	44	nC
Gate-source charge		Q <sub>gs</sub>		-	3.7	-	
Gate-drain ("miller") Charge		Q <sub>gd</sub>		-	15	-	

## Source-Drain Ratings and Characteristics (Ta = 25°C)

Characteristics	Symbol	Test Condition	Min	Type	Max	Unit
Continuous drain reverse current	I <sub>DR</sub>	-	-	-	4.5	A
Pulse drain reverse current	I <sub>DRP</sub>	-	-	-	18	A
Forward voltage (diode)	V <sub>DSF</sub>	I <sub>DR</sub> = 4.5 A, V <sub>GS</sub> = 0 V	-	-	1.4	V
Reverse recovery time	t <sub>rr</sub>	I <sub>DR</sub> = 4.5 A, V <sub>GS</sub> = 0 V, dI <sub>DR</sub> / dt = 100 A / μs	-	305	-	ns
Reverse recovery charge	Q <sub>rr</sub>		-	2.6	-	μC

Note 1.Repeativity rating :pulse width limited by junction temperature

2.L=24mH,I<sub>AS</sub>=4.5A,V<sub>DD</sub>=50V,R<sub>G</sub>=25Ω,Starting T<sub>J</sub>=25°C

3.I<sub>SD</sub>≤4.5A,di/dt≤300A/us, V<sub>DD</sub><BV<sub>DSS</sub>,STARTING T<sub>J</sub>=25°C

4.Pulse Test: Pulse Width≤300us,Duty Cycle≤2%

5.Essentially independent of operating temperature.

This transistor is an electrostatic sensitive device

Please handle with caution

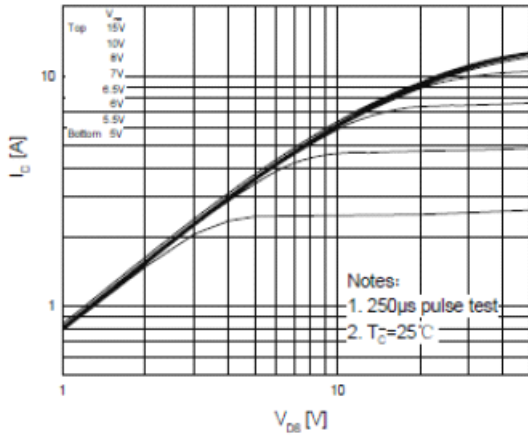

**Fig.1 On-State Characteristics**

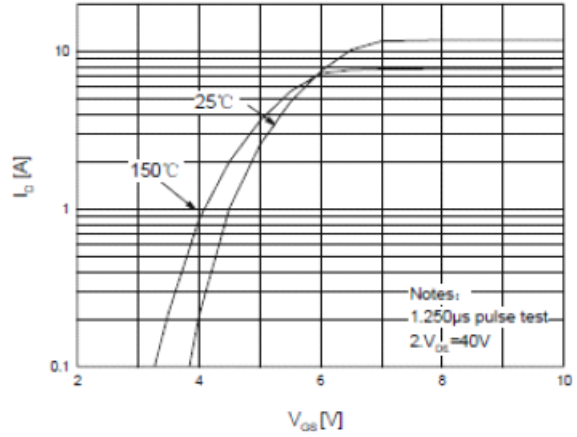

**Fig.2 Transfer Current characteristics**

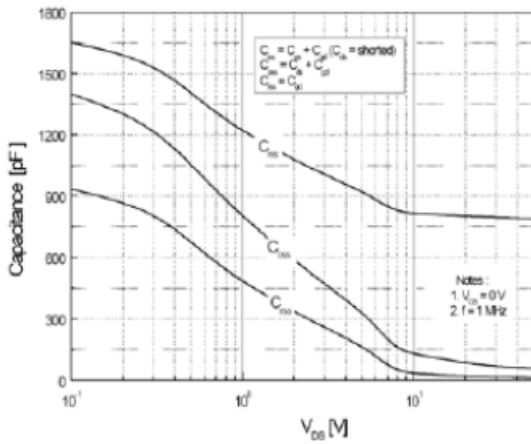

**Fig.3 Capacitance Variation vs drain voltage**

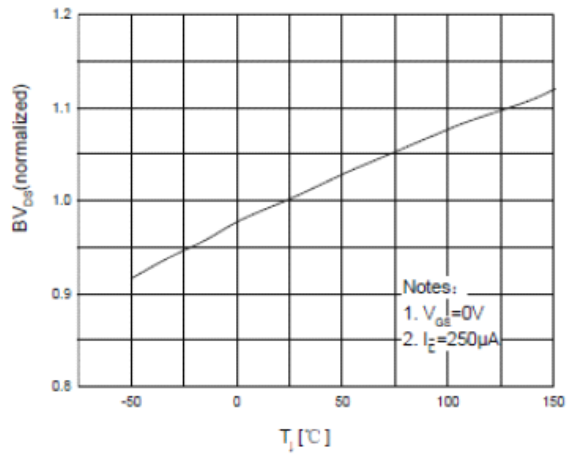

**Fig.4 Breakdown Voltage Variation Vs Temperature**

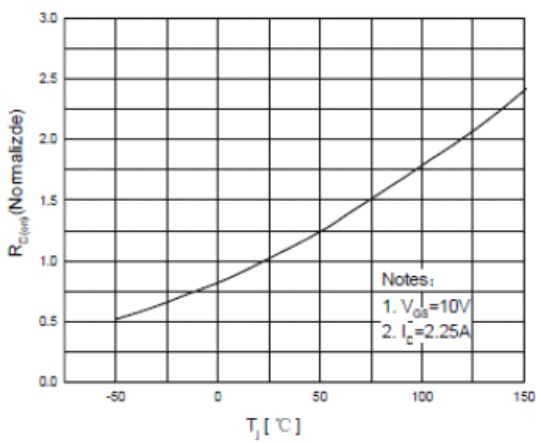

**Fig.5 On-Resistance Variation vs. Junction Temperature**

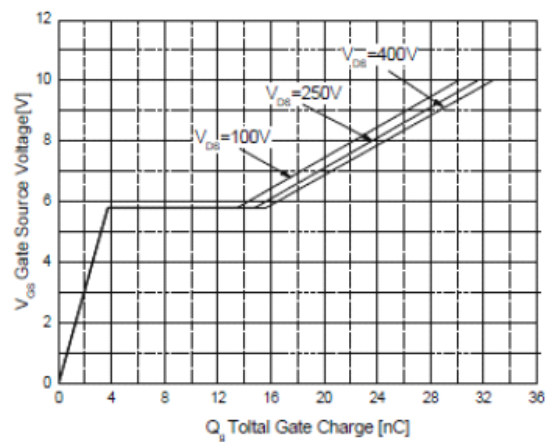

**Fig.6 Gate Charge Characteristics**

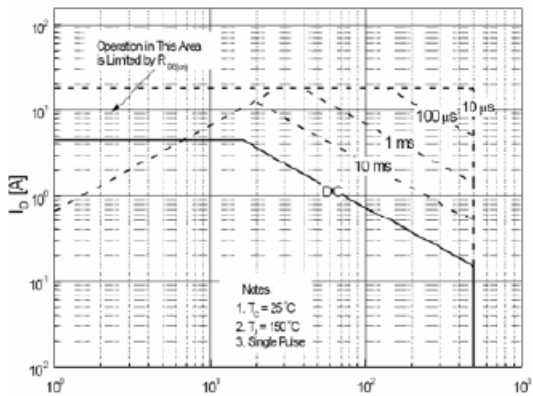

**Fig.7 Maximum Safe Operation Area**

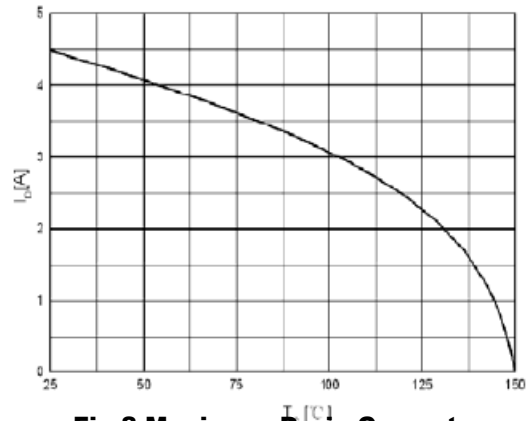

**Fig.8 Maximum Drain Current vs Case Temperature**

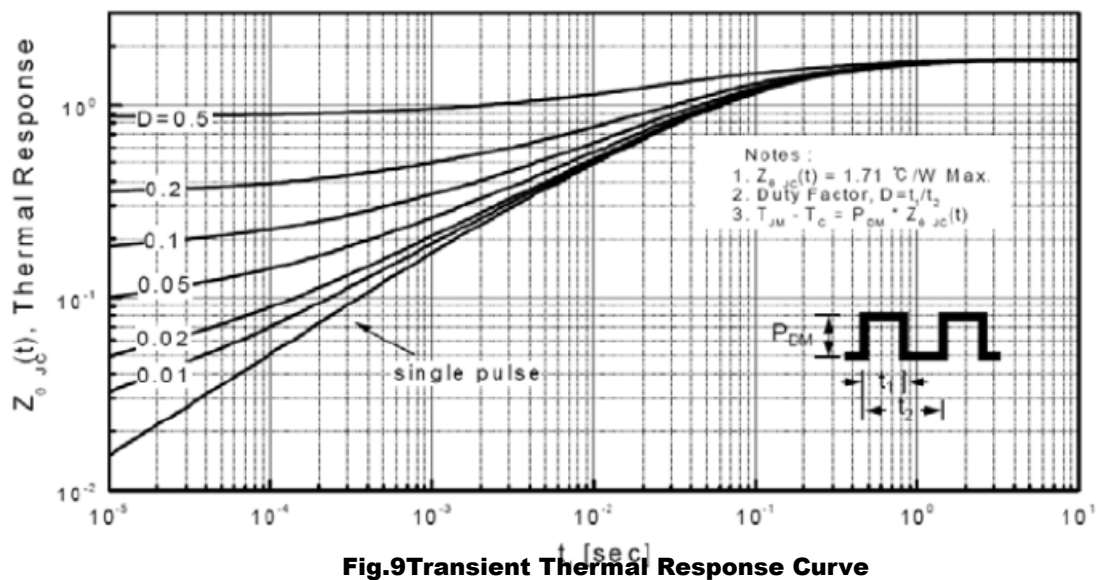

**Fig.9 Transient Thermal Response Curve**

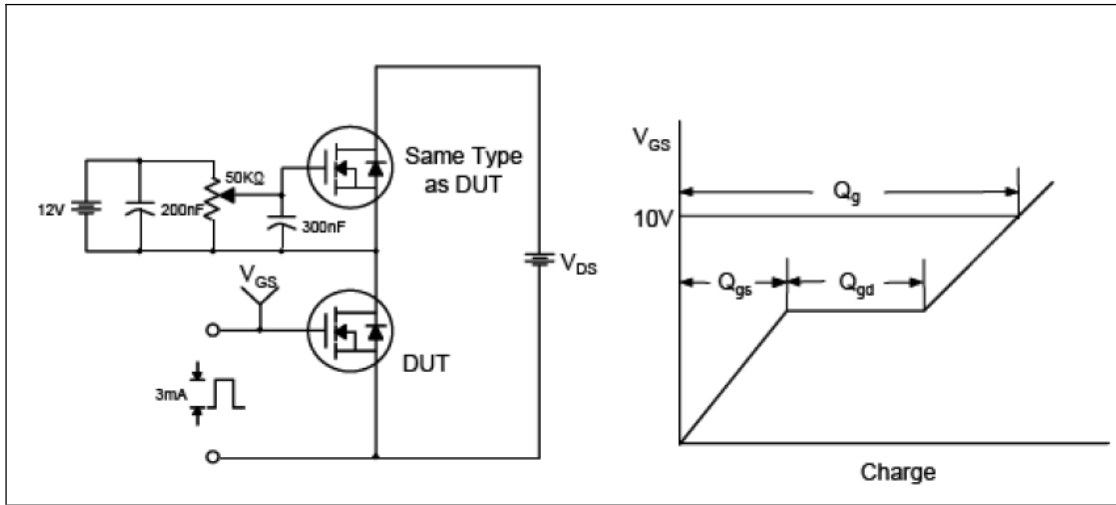

**Fig.10 Gate Test Circuit & Waveform**

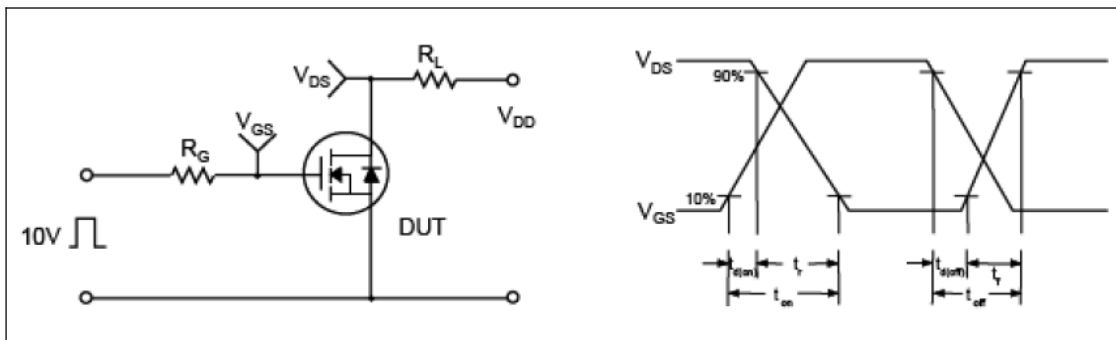

**Fig.11 Resistive Switching Test Circuit & Waveform**

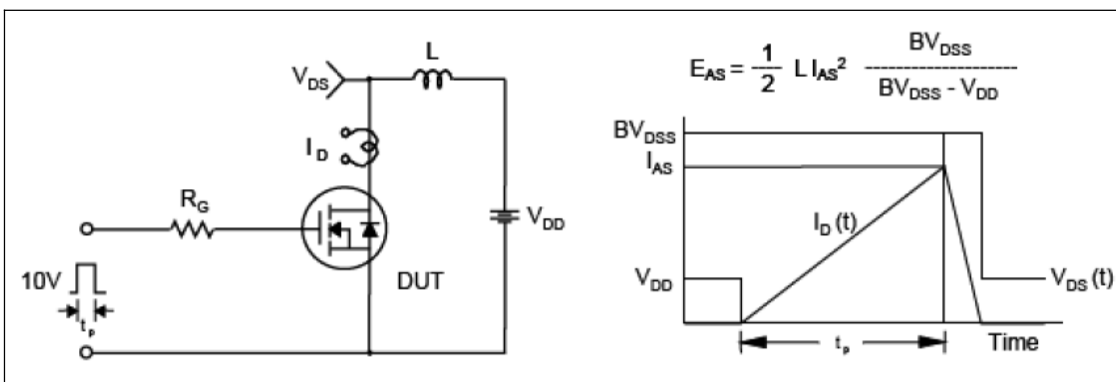

**Fig.12 Unclamped Inductive Switching Test Circuit & Waveform**

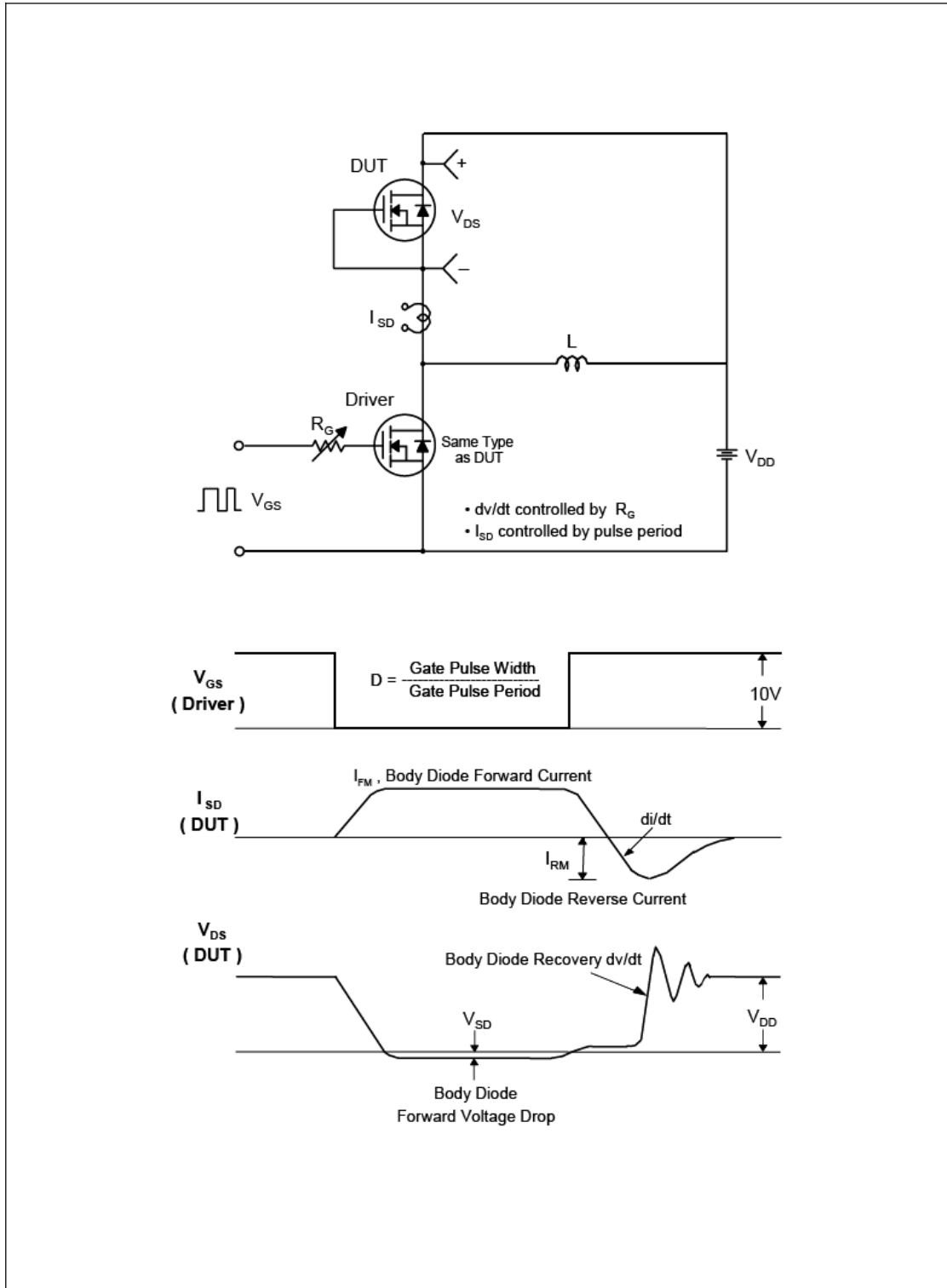

**Fig.13 Peak Diode Recovery  $dv/dt$  Test Circuit & Waveform**

**TO-252 Package Dimension**

