

Silicon N-Channel MOSFET

Features

- 4.5A,500V, $R_{DS(on)}$ (Max 1.5 Ω)@ $V_{GS}=10V$
- Ultra-low Gate Charge(Typical 32nC)
- Fast Switching Capability
- 100%Avalanche Tested
- Maximum Junction Temperature Range(150°C)

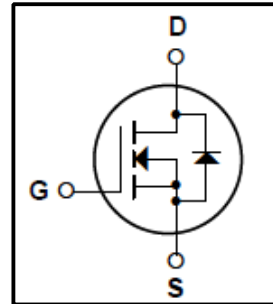

General Description

This Power MOSFET is produced using Winsemi's advanced planar stripe, DMOS technology. This latest technology has been especially designed to minimize on-state resistance, have a high rugged avalanche characteristics. This devices is specially well suited for high efficiency switch model power supplies, power factor correction and half bridge and full bridge resonant topology line a electronic lamp ballast.

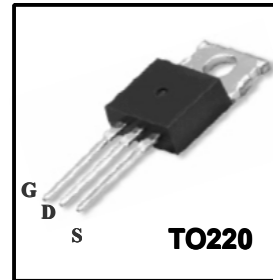

Absolute Maximum Ratings

Symbol	Parameter	Value	Units
V_{DSS}	Drain Source Voltage	500	V
I_D	Continuous Drain Current(@ $T_c=25^\circ C$)	4.5	A
	Continuous Drain Current(@ $T_c=100^\circ C$)	2.9	A
I_{DM}	Drain Current Pulsed (Note 1)	18	A
V_{GS}	Gate to Source Voltage	± 30	V
E_{AS}	Single Pulsed Avalanche Energy (Note 2)	300	mJ
E_{AR}	Repetitive Avalanche Energy (Note 1)	7.5	mJ
dv/dt	Peak Diode Recovery dv/dt (Note 3)	4.5	V/ns
P_D	Total Power Dissipation(@ $T_c=25^\circ C$)	73	W
	Derating Factor above 25°C	0.55	W/°C
T_J, T_{stg}	Junction and Storage Temperature	-55~150	°C
T_L	Maximum lead Temperature for soldering purposes	300	°C

Thermal Characteristics

Symbol	Parameter	Value			Units
		Min	Typ	Max	
R_{QJC}	Thermal Resistance, Junction-to-Case	-	-	1.7	°C/W
R_{QCS}	Thermal Resistance, Case to Sink	-	0.5	-	°C/W
R_{QJA}	Thermal Resistance, Junction-to-Ambient	-	-	62.5	°C/W

Electrical Characteristics (Tc = 25°C)

Characteristics	Symbol	Test Condition	Min	Type	Max	Unit	
Gate leakage current	I_{GSS}	$V_{GS} = \pm 30 V, V_{DS} = 0 V$	-	-	± 100	nA	
Gate-source breakdown voltage	$V_{(BR)GSS}$	$I_G = \pm 10 \mu A, V_{DS} = 0 V$	± 30	-	-	V	
Drain cut-off current	I_{DSS}	$V_{DS} = 500 V, V_{GS} = 0 V$	-	-	1	μA	
Drain-source breakdown voltage	$V_{(BR)DSS}$	$I_D = 250 \mu A, V_{GS} = 0 V$	500	-	-	V	
Break Voltage Temperature Coefficient	$\frac{\Delta BV_{DSS}}{\Delta T_J}$	$I_D = 250 \mu A$, Referenced to 25°C	-	0.55	-	V/°C	
Gate threshold voltage	$V_{GS(th)}$	$V_{DS} = 10 V, I_D = 250 \mu A$	2	-	4	V	
Drain-source ON resistance	$R_{DS(ON)}$	$V_{GS} = 10 V, I_D = 2.25 A$	-	1.16	1.5	Ω	
Forward Transconductance	gfs	$V_{DS} = 40 V, I_D = 2.25 A$	-	4.2		S	
Input capacitance	C_{iss}	$V_{DS} = 25 V,$	-	800	1050	pF	
Reverse transfer capacitance	C_{rss}	$V_{GS} = 0 V,$	-	18	23		
Output capacitance	C_{oss}	$f = 1 MHz$	-	76	100		
Switching time	Rise time	t_r	$V_{DD} = 250 V,$ $I_D = 4.5 A$ $R_G = 25 \Omega$ (Note4,5)	-	15	40	ns
	Turn-on time	t_{on}		-	40	90	
	Fall time	t_f		-	85	180	
	Turn-off time	t_{off}		-	45	100	
Total gate charge (gate-source plus gate-drain)	Q_g	$V_{DD} = 400 V,$ $V_{GS} = 10 V,$ $I_D = 4.5 A$ (Note4,5)	-	32	44	nC	
Gate-source charge	Q_{gs}		-	3.7	-		
Gate-drain ("miller") Charge	Q_{gd}		-	15	-		

Source-Drain Ratings and Characteristics (Ta = 25°C)

Characteristics	Symbol	Test Condition	Min	Type	Max	Unit
Continuous drain reverse current	I_{DR}	-	-	-	4.5	A
Pulse drain reverse current	I_{DRP}	-	-	-	18	A
Forward voltage (diode)	V_{DSF}	$I_{DR} = 4.5 A, V_{GS} = 0 V$	-	-	1.4	V
Reverse recovery time	t_{rr}	$I_{DR} = 4.5 A, V_{GS} = 0 V,$	-	305	-	ns
Reverse recovery charge	Q_{rr}	$di_{DR} / dt = 100 A / \mu s$	-	2.6	-	μC

Note 1.Repeativity rating :pulse width limited by junction temperature

2.L=24mH, $I_{AS}=4.5A, V_{DD}=50V, R_G=25\Omega$,Starting $T_J=25^\circ C$

3. $I_{SD} \leq 4.5A, di/dt \leq 300A/\mu s, V_{DD} < BV_{DSS}$,STARTING $T_J=25^\circ C$

4.Pulse Test: Pulse Width $\leq 300\mu s$,Duty Cycle $\leq 2\%$

5.Essentially independent of operating temperature.

This transistor is an electrostatic sensitive device

Please handle with caution

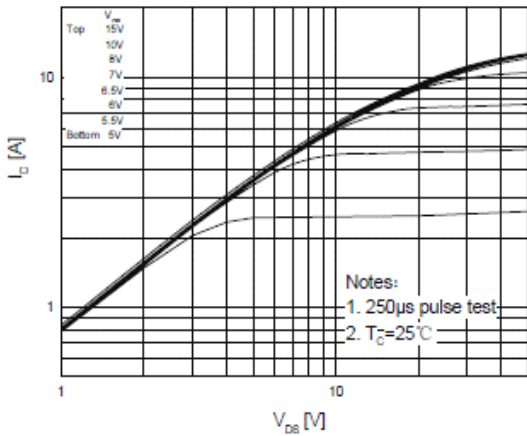

Fig. 1 On-State Characteristics

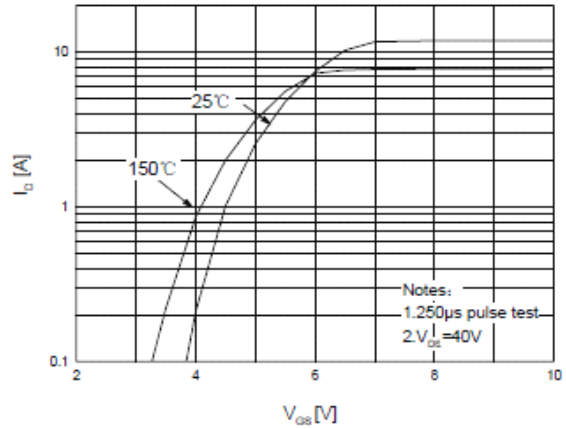

Fig. 2 Transfer Characteristics

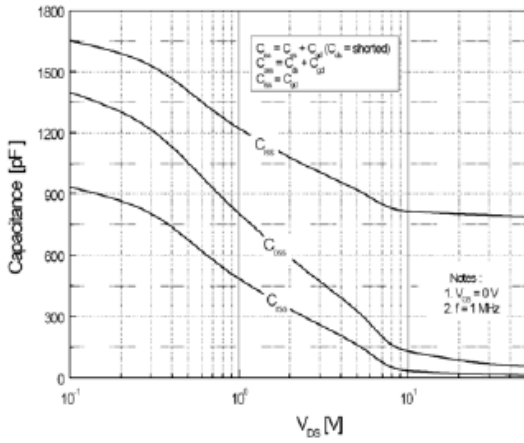

Fig. 3 Capacitance Variation vs Drain Voltage

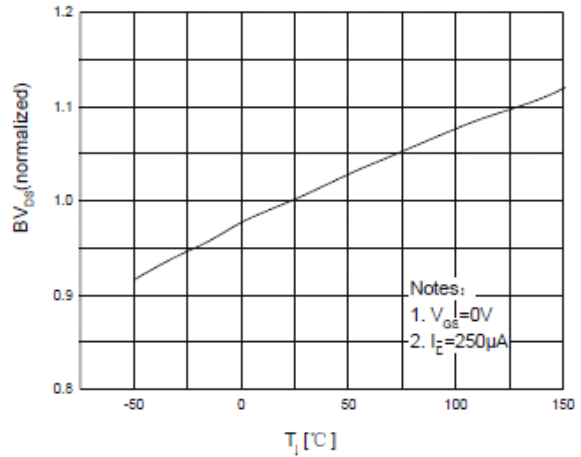

Fig. 4 Breakdown Voltage Variation vs Temperature

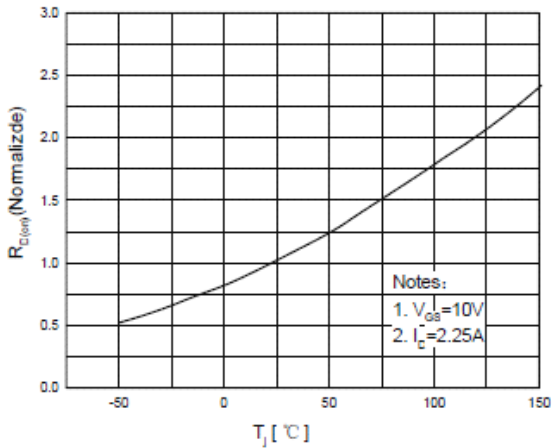

Fig. 5 On-Resistance Variation vs Junction Temperature

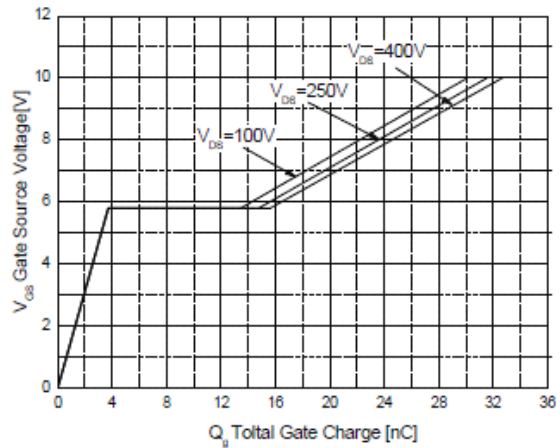

Fig. 6 Gate Charge Characteristics

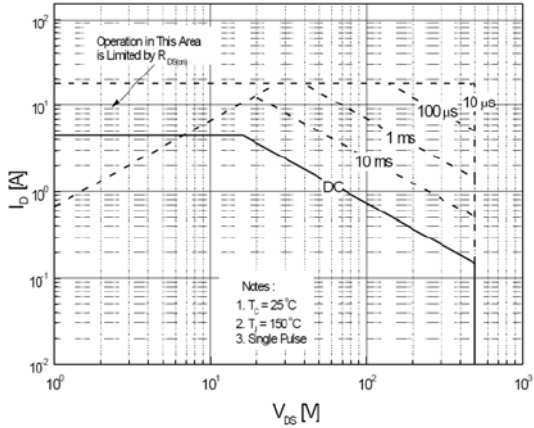

Fig.7 Maximum Safe Operation Area

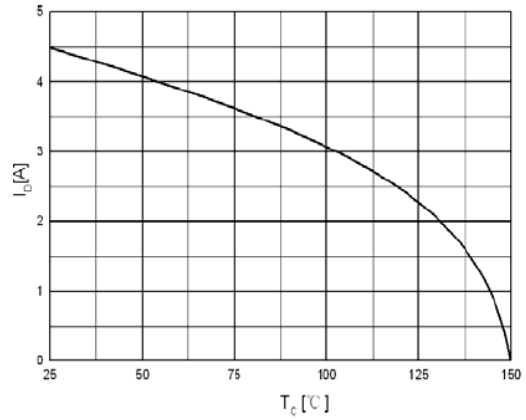

Fig.8 Maximum Drain Current vs Case Temperature

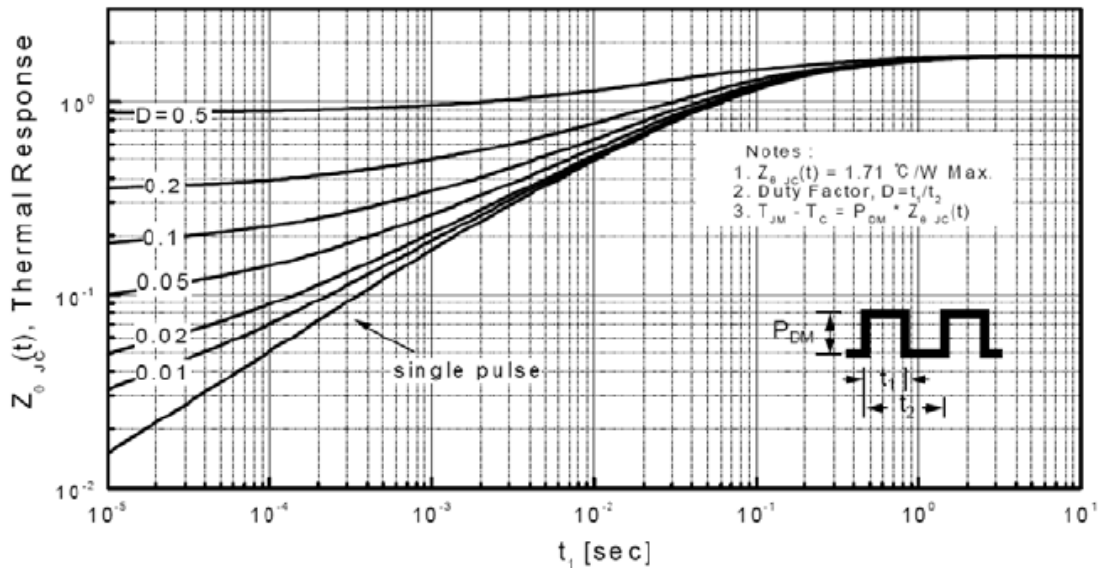

Fig.9 Transient Thermal Response Curve

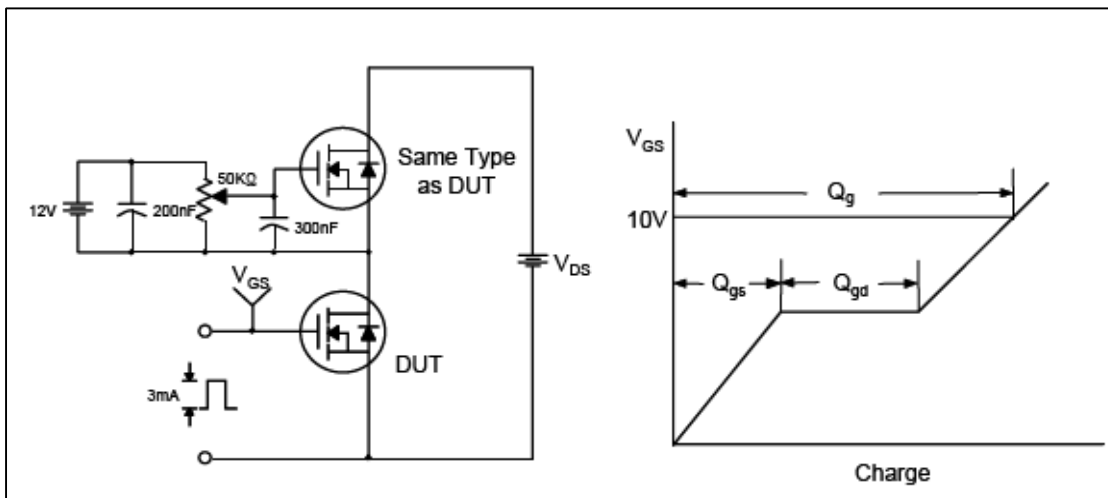

Fig.10 Gate Test Circuit & Waveform

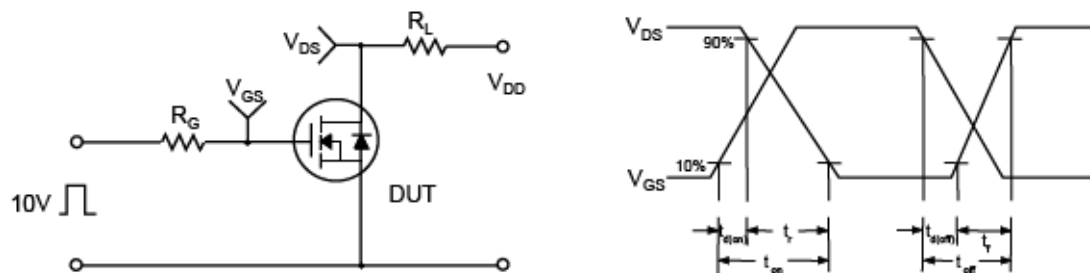

Fig.11 Resistive Switching Test Circuit & Waveform

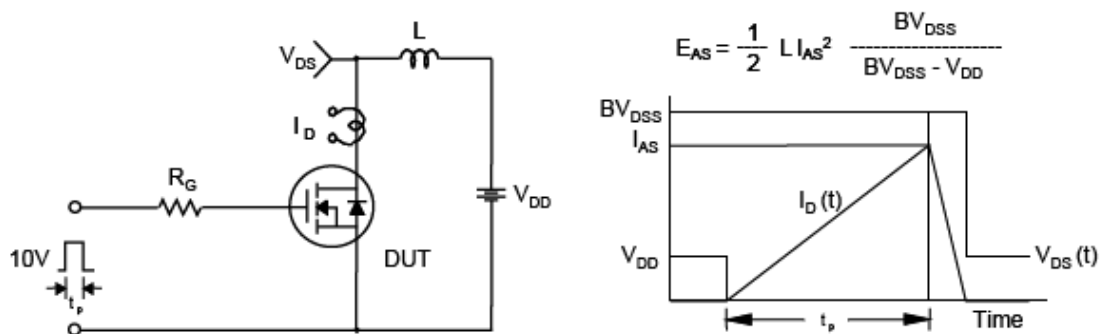

Fig.12 Unclamped Inductive Switching Test Circuit & Waveform

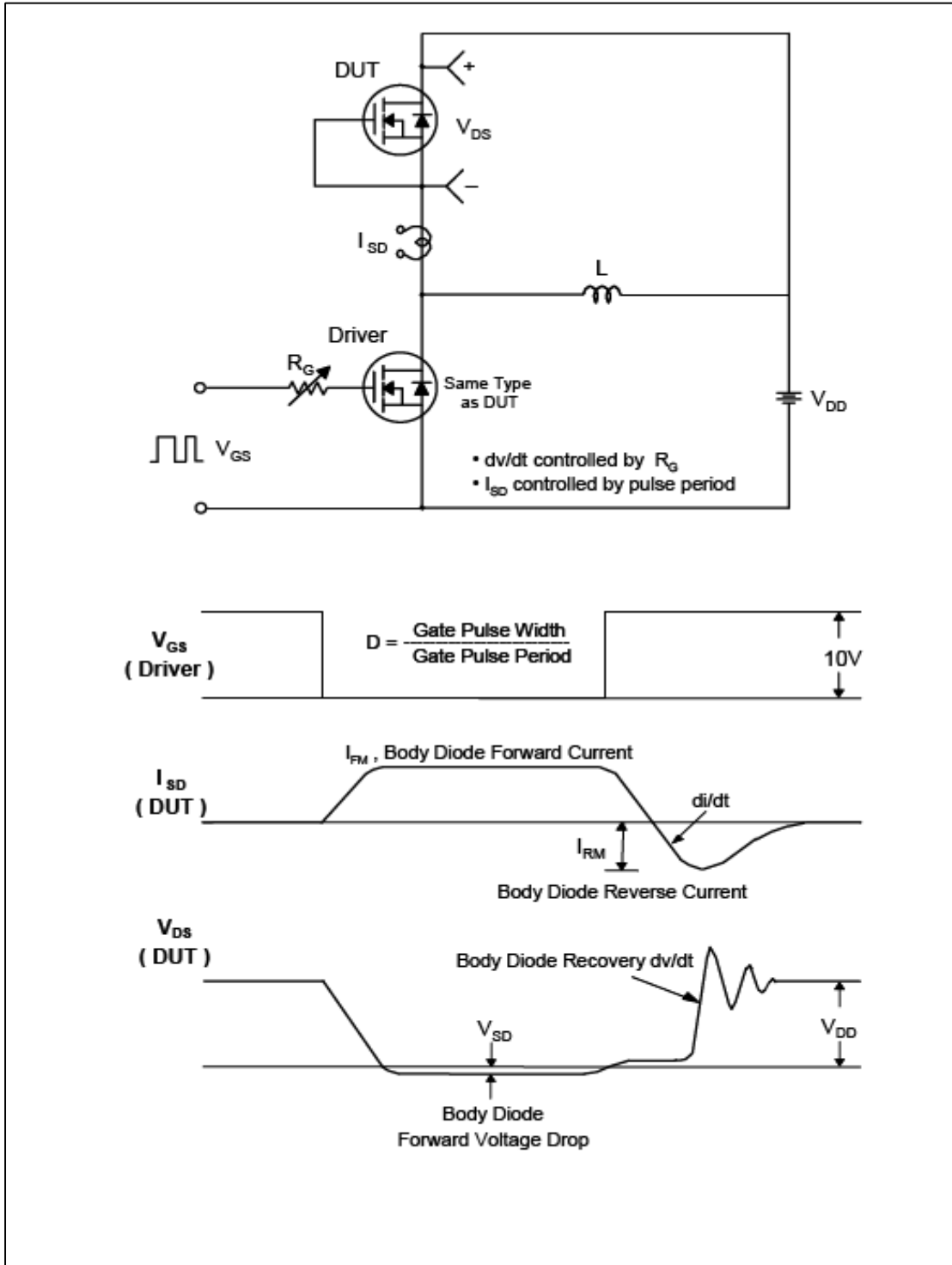

Fig.13 Peak Diode Recovery dv/dt Test Circuit & Waveform

TO-220C Package Dimension

