

*N- Channel and P-Channel Silicon MOSFETs*

**Features**

- Low On-resistance.
- Composite type with an N-channel MOSFET and a P-channel MOSFET driving from a 4.5V/-4.5V supply voltage contained in a single package.
- High-density mounting.
- RoHS compliant.

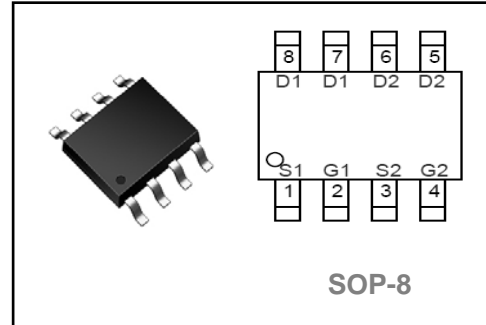

**Applications**

- General-Purpose Switching Device
- For motor drives, inverters.

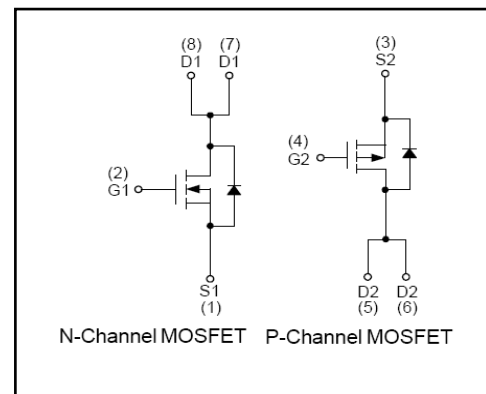

**Absolute Maximum Ratings at Ta=250C**

Parameter	Symbol	Conditions	Ratings		Unit
			N-Ch	P-Ch	
Drain-to-Source Voltage	$V_{DSS}$		60	-60	V
Gate-to-Source Voltage	$V_{GSS}$		$\pm 25$	$\pm 25$	V
Drain Current (DC)	$I_D$		5	-3.5	A
Drain Current (Pulse)	$I_{DP}$	$PW \leq 10\mu s$ , duty cycle $\leq 1\%$	20	-14	A
Allowable Power Dissipation	$P_D$	Mounted on a ceramic board (1000mm <sup>2</sup> ×0.8mm) 1unit	1.3		W
Total Dissipation	$P_T$	Mounted on a ceramic board (1000mm <sup>2</sup> ×0.8mm)	1.7		W
Channel Temperature	$T_{ch}$		150		°C
Storage Temperature	$T_{stg}$		-55~+150		°C

## N-Channel Electrical Characteristics at Ta=25°C

Parameter	Symbol	Conditions	Ratings			Unit
			min	typ	max	
Drain-to-Source Breakdown Voltage	$V_{(BR)DSS}$	$I_D=250\mu A, V_{GS}=0V$	60	-	-	V
Zero-Gate Voltage Drain Current	$I_{DSS}$	$V_{DS}=48V, V_{GS}=0V$	-	-	1	$\mu A$
Gate-to-Source Leakage Current	$I_{GSS}$	$V_{GS}=\pm 25V, V_{DS}=0V$	-	-	$\pm 100$	nA
Gate Threshold Voltage	$V_{GS(th)}$	$V_{DS}=V_{GS}, I_D=250\mu A$	1	2	2.5	V
Static Drain-to-Source On-State Resistance	$R_{DS(on)}$	$I_D=5A, V_{GS}=10V$	-	38	52	m $\Omega$
	$R_{DS(on)}$	$I_D=4A, V_{GS}=4.5V$	-	55	75	m $\Omega$
Input Capacitance	$C_{iss}$	$V_{DS}=30V,$	-	915	-	pF
Output Capacitance	$C_{oss}$	$V_{GS}=0V,$	-	70	-	
Reverse Transfer Capacitance	$C_{rss}$	$f=1MHz$	-	45	-	
Turn-on Delay Time	$t_{d(on)}$	$V_{GEN}=10V,$	-	9	17	nS
Rise Time	$t_r$	$V_{DS}=30V,$	-	6	12	
Turn-off Delay Time	$t_{d(off)}$	$R_L=30\Omega, I_D=1A,$	-	25	46	
Fall Time	$t_f$	$R_{GEN}=6\Omega$	-	5	10	
Total Gate Charge	$Q_g$	$V_{DS}=30V,$	-	19	27	nC
Gate-to-Source Charge	$Q_{gs}$	$V_{GS}=10V,$	-	4.4	-	
Gate-to-Drain "Miller" Charge	$Q_{gd}$	$I_D=5A$	-	4.4	-	
Diode Forward Voltage	$V_{SD}$	$I_S=2.5A, V_{GS}=0V$	-	0.8	1.1	V

N-Channel Typical Characteristics at  $T_a=25^\circ\text{C}$

**Output Characteristics**

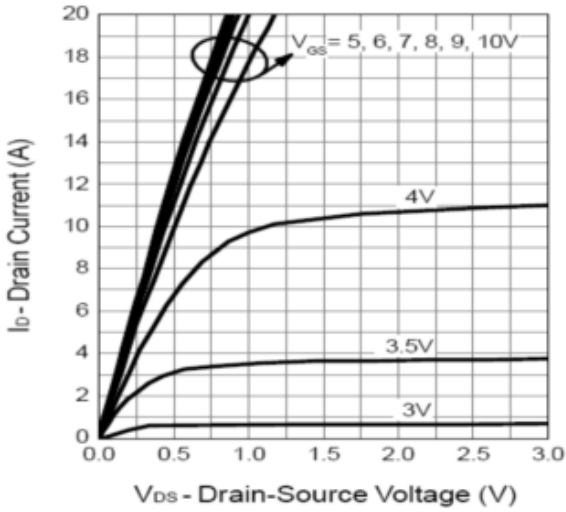

**Drain-Source On Resistance**

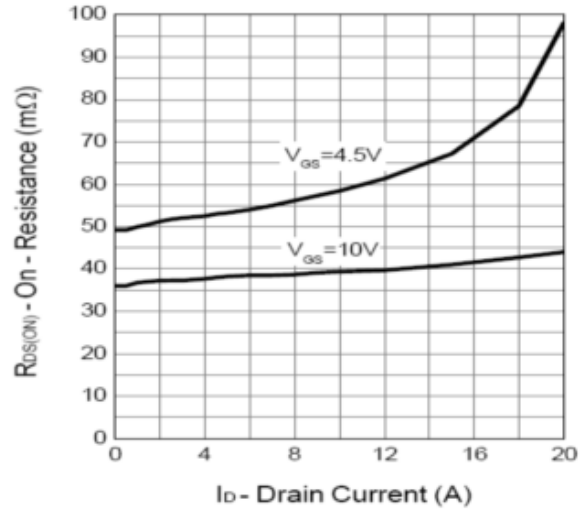

**Drain-Source On Resistance**

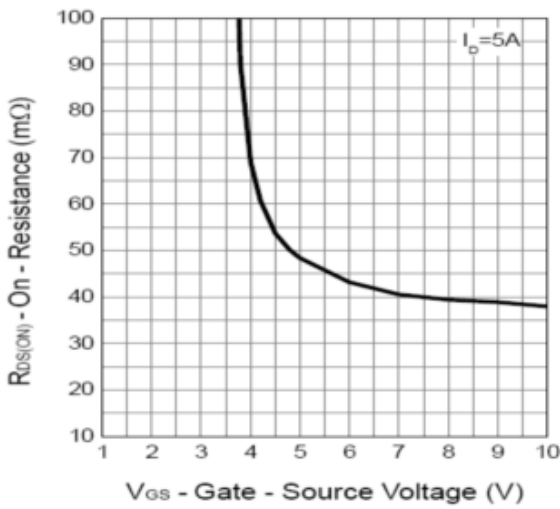

**Gate Threshold Voltage**

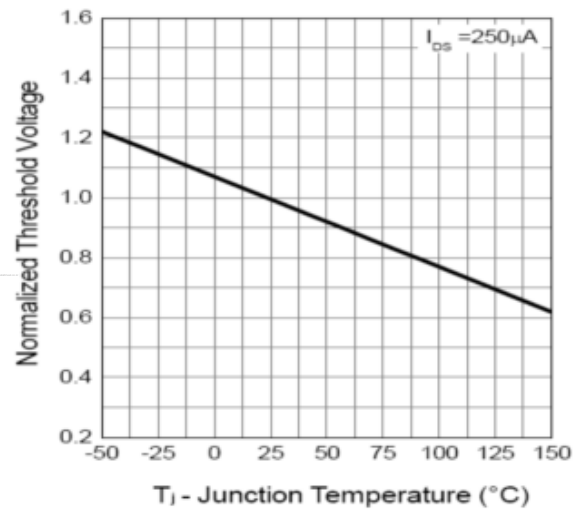

**Drain-Source On Resistance**

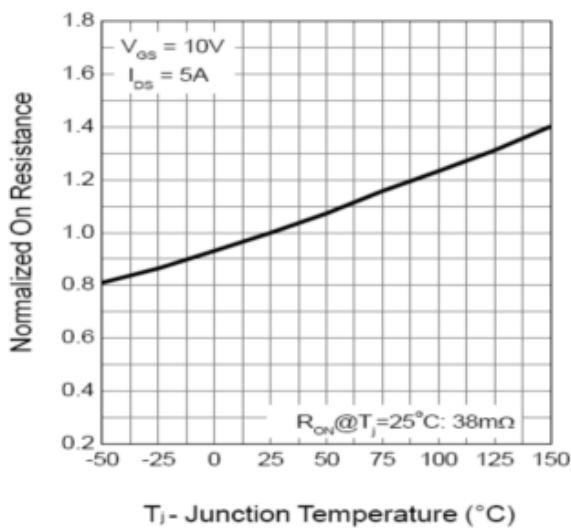

**Source-Drain Diode Forward**

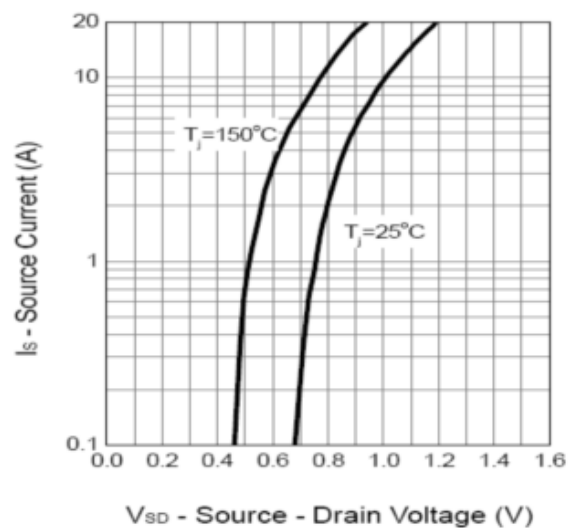

**Capacitance**

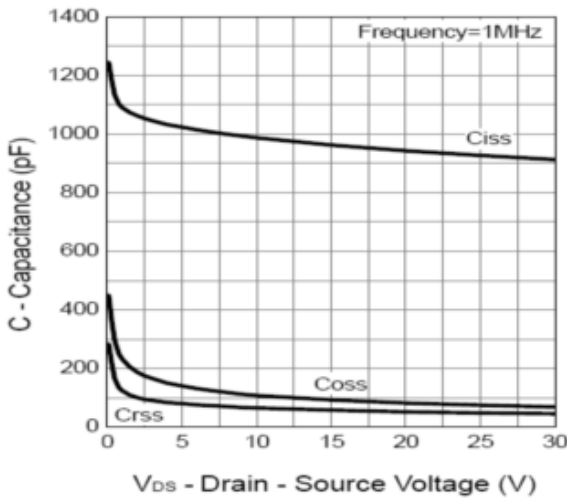

**Gate Charge**

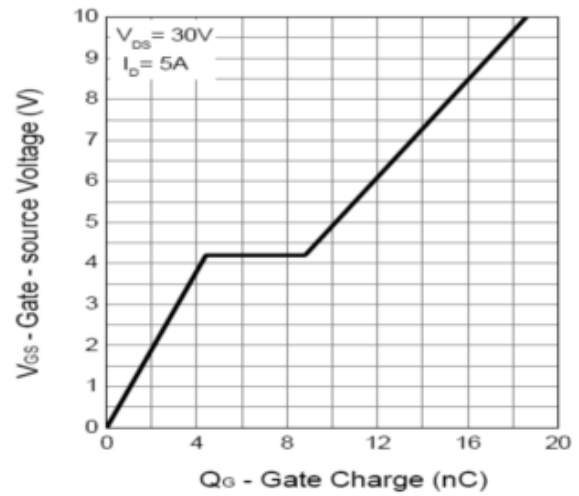

**Power Dissipation**

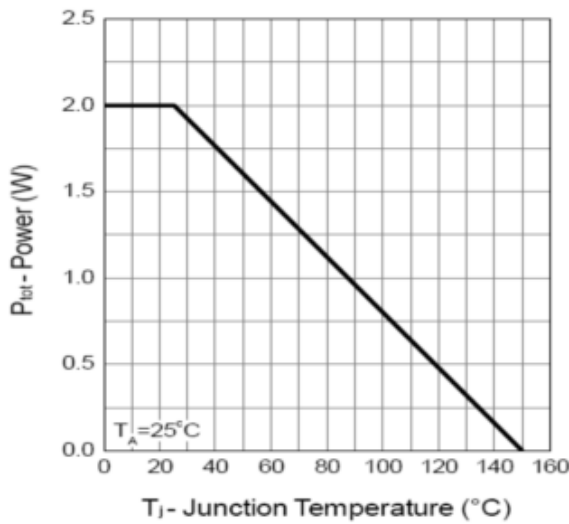

**Drain Current**

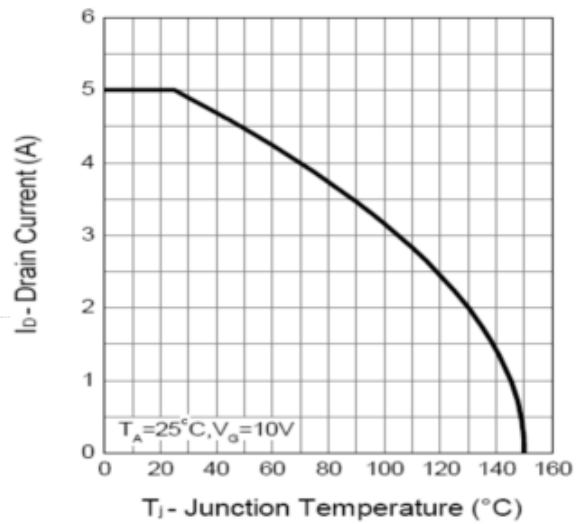

**Safe Operation Area**

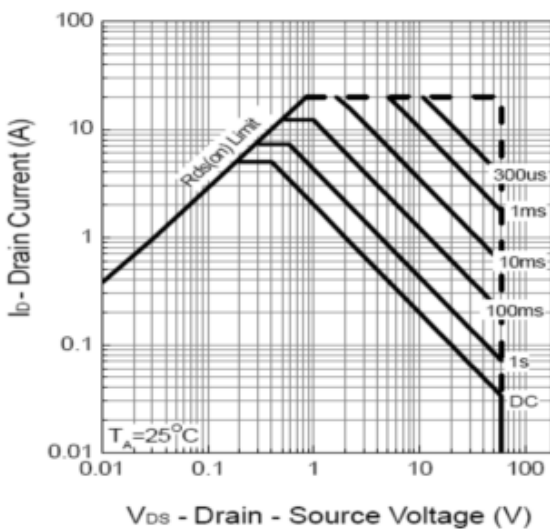

**Thermal Transient Impedance**

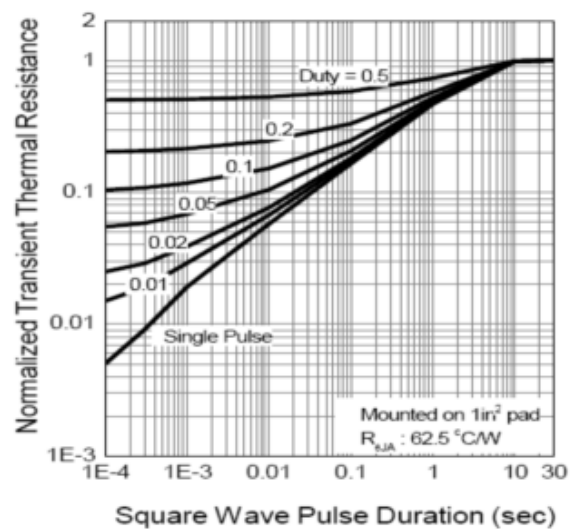

## P-Channel Electrical Characteristics at $T_a=25^{\circ}\text{C}$

Parameter	Symbol	Conditions	Ratings			Unit
			min	typ	max	
Drain-to-Source Breakdown Voltage	$V_{(BR)DSS}$	$I_D=-250\mu\text{A}, V_{GS}=0\text{V}$	-60	-	-	V
Zero-Gate Voltage Drain Current	$I_{DSS}$	$V_{DS}=-48\text{V}, V_{GS}=0\text{V}$	-	-	-1	$\mu\text{A}$
Gate-to-Source Leakage Current	$I_{GSS}$	$V_{GS}=\pm 25\text{V}, V_{DS}=0\text{V}$	-	-	$\pm 100$	nA
Gate Threshold Voltage	$V_{GS(th)}$	$V_{DS}=V_{GS}, I_D=-250\mu\text{A}$	-1	-2	-2.5	V
Static Drain-to-Source On-State Resistance	$R_{DS(on)}$	$I_D=-3.5\text{A}, V_{GS}=-10\text{V}$	-	80	100	m $\Omega$
	$R_{DS(on)}$	$I_D=-3.1\text{A}, V_{GS}=-4.5\text{V}$	-	100	135	m $\Omega$
Input Capacitance	$C_{iss}$	$V_{DS}=-30\text{V},$	-	1050	-	pF
Output Capacitance	$C_{oss}$	$V_{GS}=0\text{V},$	-	70	-	
Reverse Transfer Capacitance	$C_{rss}$	$f=1\text{MHz}$	-	50	-	
Turn-on Delay Time	$t_{d(on)}$	$V_{GEN}=-10\text{V},$	-	7	14	nS
Rise Time	$t_r$	$V_{DS}=-30\text{V},$	-	8	15	
Turn-off Delay Time	$t_{d(off)}$	$R_L=30\Omega, I_D=-1\text{A},$	-	47	86	
Fall Time	$t_f$	$R_{GEN}=6\Omega$	-	17	32	
Total Gate Charge	$Q_g$	$V_{DS}=-30\text{V},$	-	22	31	nC
Gate-to-Source Charge	$Q_{gs}$	$V_{GS}=-10\text{V},$	-	2.8	-	
Gate-to-Drain "Miller" Charge	$Q_{gd}$	$I_D=-3.5\text{A}$	-	5	-	
Diode Forward Voltage	$V_{SD}$	$I_S=-2.5\text{A}, V_{GS}=0\text{V}$	-	-0.8	-1.1	V

P-Channel Typical Characteristics at  $T_a=25^{\circ}\text{C}$

**Output Characteristics**

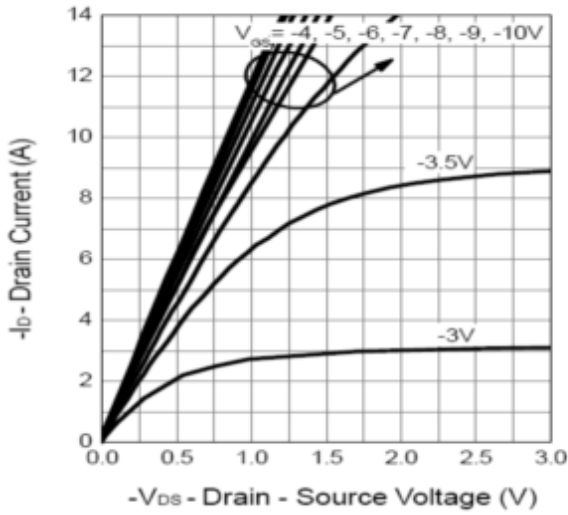

**Drain-Source On Resistance**

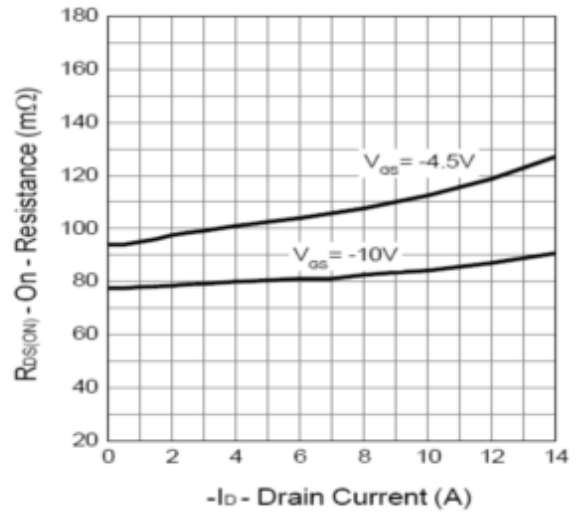

**Drain-Source On Resistance**

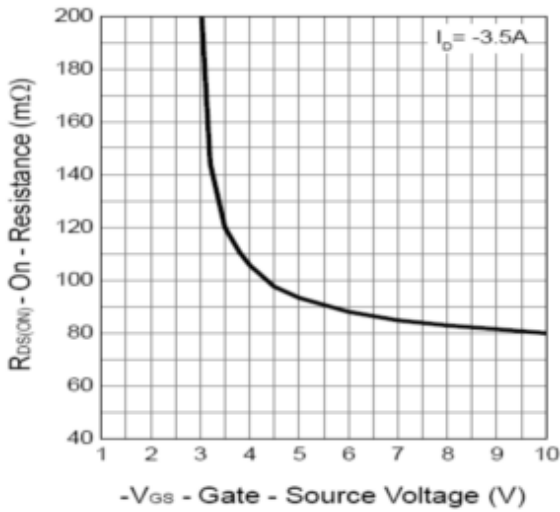

**Gate Threshold Voltage**

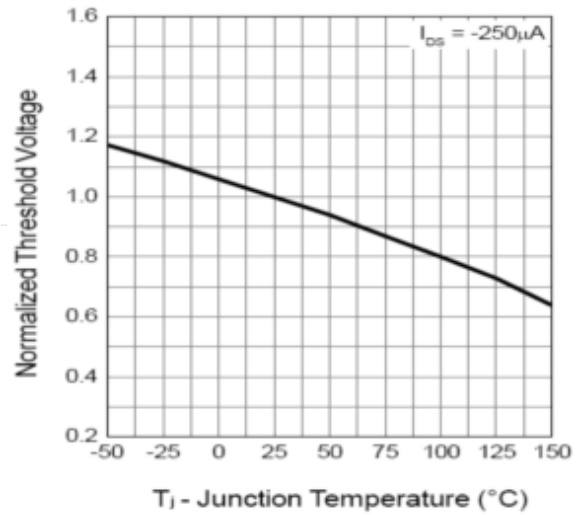

**Drain-Source On Resistance**

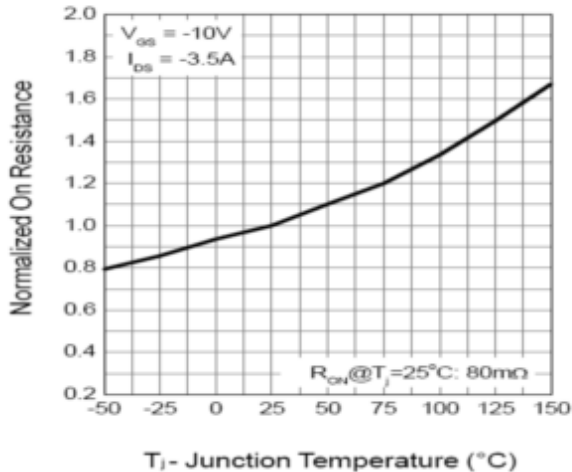

**Source-Drain Diode Forward**

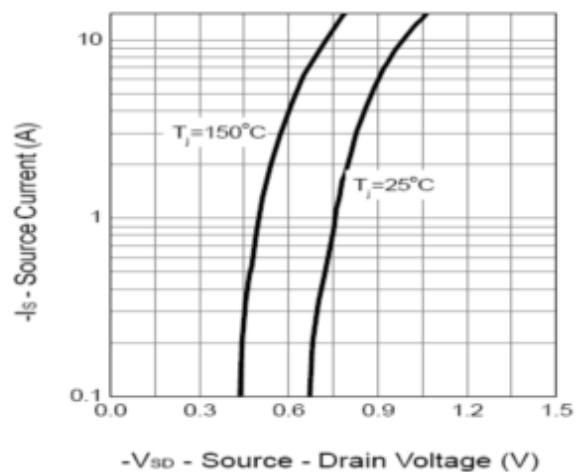

**Capacitance**

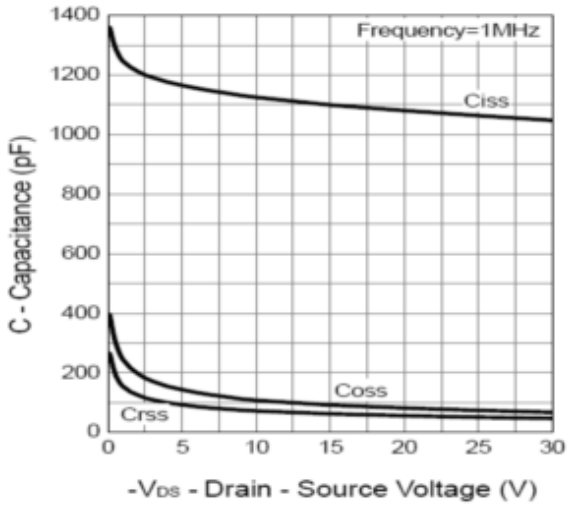

**Gate Charge**

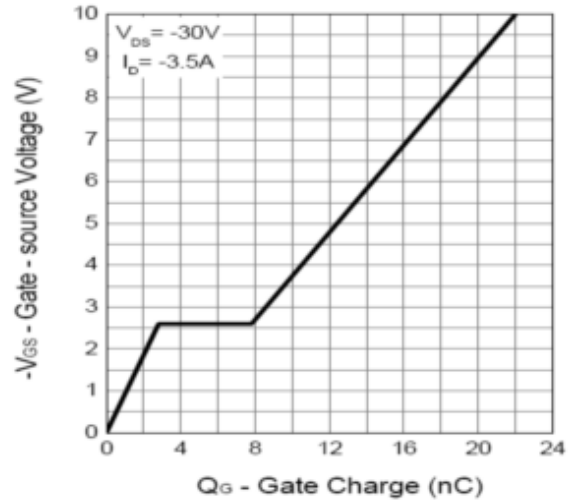

**Power Dissipation**

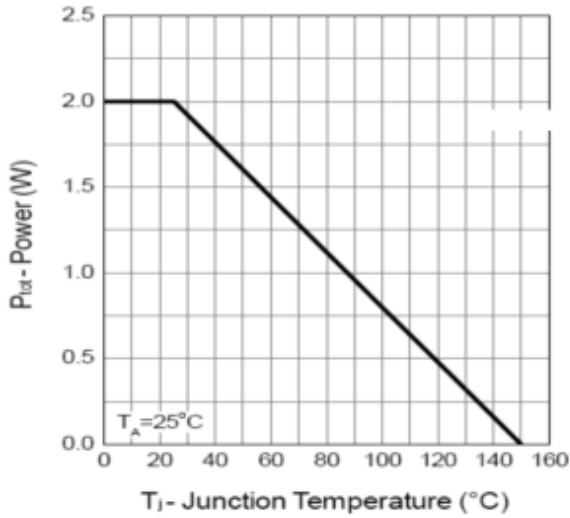

**Drain Curre.**

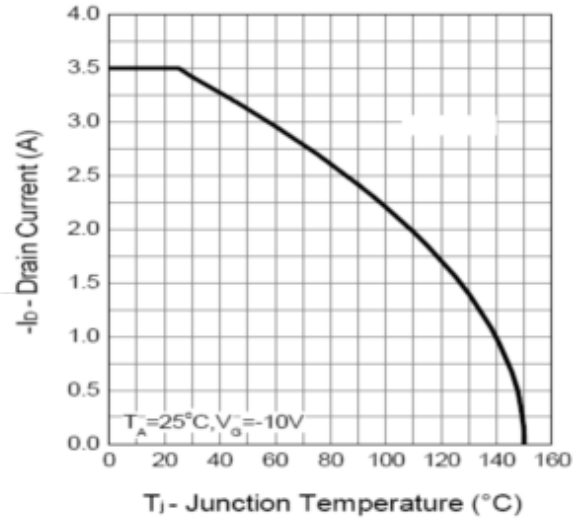

**Safe Operation Area**

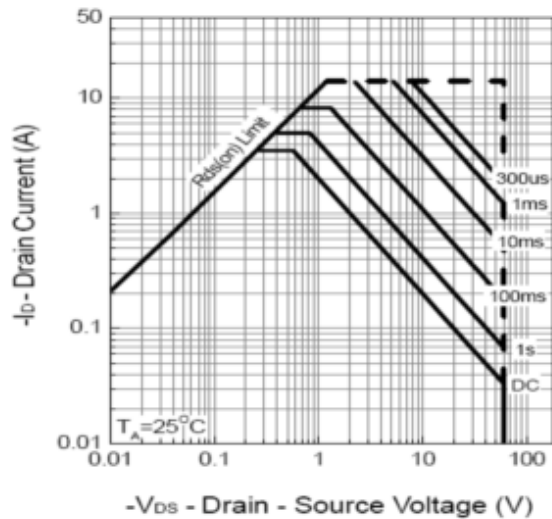

**Thermal Transient Impedance**

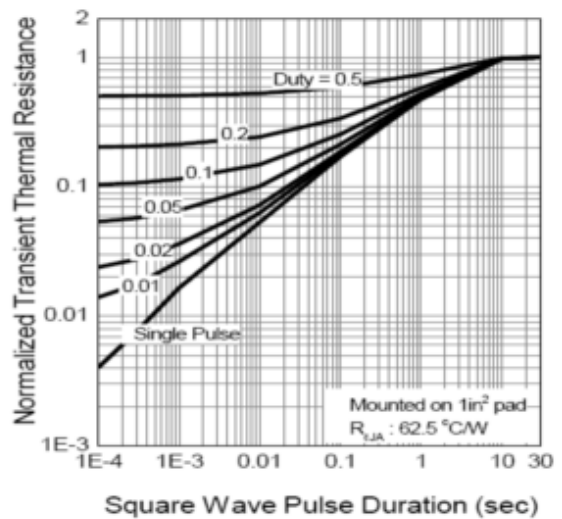

**SOP8 Package Dimension**

