

Features

- 2A,650V, $R_{DS(on)}$ (Max 5.0Ω)@ $V_{GS}=10V$
- Ultra-low Gate Charge(Typical 8nC)
- Fast Switching Capability
- 100%Avalanche Tested
- Maximum Junction Temperature Range(150℃)

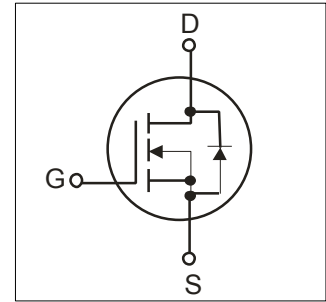

General Description

This Power MOSFET is produced using Winsemi's advanced planar stripe,VDMOS technology. This latest technology has been especially designed to minimize on -state resistance,have a high rugged avalanche characteristics. This devices is specially well suited for high efficiency switch mode power supply .

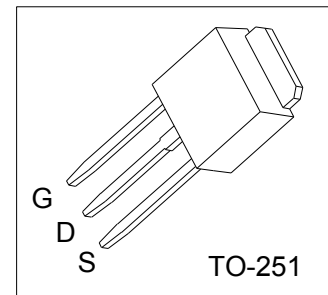

Absolute Maximum Ratings

Symbol	Parameter	Value	Units
V_{DSS}	Drain Source Voltage	650	V
I_D	Continuous Drain Current(@ $T_c=25^{\circ}C$)	2.0	A
	Continuous Drain Current(@ $T_c=100^{\circ}C$)	1.1	A
I_{DM}	Drain Current Pulsed (Note1)	6	A
V_{GS}	Gate to Source Voltage	± 30	V
E_{AS}	Single Pulsed Avalanche Energy (Note2)	210	mJ
E_{AR}	Repetitive Avalanche Energy (Note1)	4.2	mJ
dv/dt	Peak Diode Recovery dv /dt (Note3)	4.6	V/ ns
P_D	Total Power Dissipation(@ $T_c=25^{\circ}C$)	44	W
	Derating Factor above 25℃	0.35	W/℃
T_J, T_{stg}	Junction and Storage Temperature	-55~150	℃
T_L	Channel Temperature	300	℃

Thermal Characteristics

Symbol	Parameter	Value			Units
		Min	Typ	Max	
R_{QJC}	Thermal Resistance , Junction -to -Case	-	-	2.88	℃/W
R_{QJA}	Thermal Resistance , Junction-to -Ambient	-	-	110	℃/W

Electrical Characteristics(Tc=25°C)

Characteristics		Symbol	Test Condition	Min	Type	Max	Unit
Gate leakage current		I _{GSS}	V _{GS} =±30V,V _{DS} =0V	-	-	±100	nA
Gate-source breakdown voltage		V _{(BR)GSS}	I _G =±10 μA,V _{DS} =0V	±30	-	-	V
Drain cut -off current		I _{DSS}	V _{DS} =650V,V _{GS} =0V	-	-	10	μA
			V _{DS} =520V,Tc=125°C	-	-	100	μA
Drain -source breakdown voltage		V _{(BR)DSS}	I _D =250 μA,V _{GS} =0V	650	-	-	V
Gate threshold voltage		V _{GS(th)}	V _{DS} = V _{GS} ,I _D =250 μA	2	-	4	V
Drain -source ON resistance		R _{DS(ON)}	V _{GS} =10V,I _D =1A	-	4.0	5.0	Ω
Forward Transconductance		g _{fs}	V _{DS} =40V,I _D =1A	-	2.45	-	S
Input capacitance		C _{iss}	V _{DS} =25V,	-	420	482	pF
Reverse transfer capacitance		C _{rss}	V _{GS} =0V,	-	3.8	4.0	
Output capacitance		C _{oss}	f=1MHz	-	14	19	
Switching time	Turn-on Rise time	t _r	V _{DD} =350V, I _D =2A, R _G =25Ω, (Note4,5)	-	30	48	ns
	Turn-on delay time	T _{d(on)}		-	9	24	
	Turn-off Fall time	t _f		-	32	50	
	Turn-off delay time	T _{d(off)}		-	27	47	
Total gate charge(gate-source plus gate-drain)		Q _g	V _{DD} =520V, V _{GS} =10V, I _D =2A	-	8	10	nC
Gate-source charge		Q _{gs}	(Note4,5)	-	1.3	-	
Gate-drain("miller") Charge		Q _{gd}	(Note4,5)	-	4.3	-	

Source-Drain Ratings and Characteristics(Ta=25°C)

Characteristics	Symbol	Test Condition	Min	Type	Max	Unit
Continuous drain reverse current	I _{DR}	-	-	-	2.0	A
Pulse drain reverse current	I _{DRP}	-	-	-	6.0	A
Forward voltage(diode)	V _{DSF}	I _{DR} =2.0A,V _{GS} =0V	-	-	1.4	V
Reverse recovery time	t _{rr}	I _{DR} =2.A,V _{GS} =0V,	-	220	-	ns
Reverse recovery charge	Q _{rr}	dI _{DR} / dt =100 A / μs	-	1.0	-	μC

Note 1.Repeativity rating :pulse width limited by junction temperature

2.L=56mH I_{AS}=2A,V_{DD}=50V,R_G=25Ω ,Starting T_J=25°C

3.I_{SD}≤2A,di/dt≤200A/us,V_{DD}<BV_{DSS},Starting T_J=25°C

4.Pulse Test:Pulse Width≤300us,Duty Cycle≤2%

5. Essentially independent of operating temperature.

This transistor is an electrostatic sensitive device

Please handle with caution

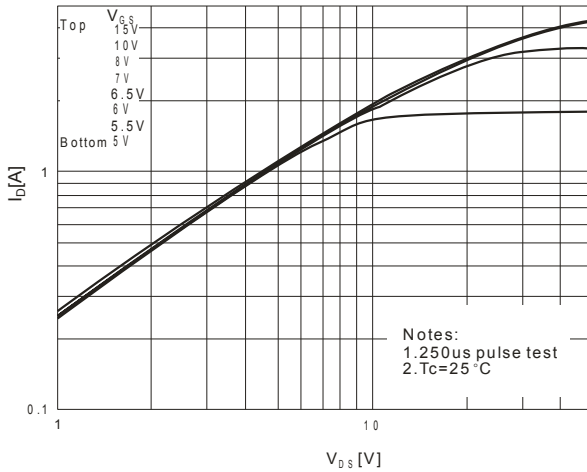

Fig.1 On-Region Characteristics

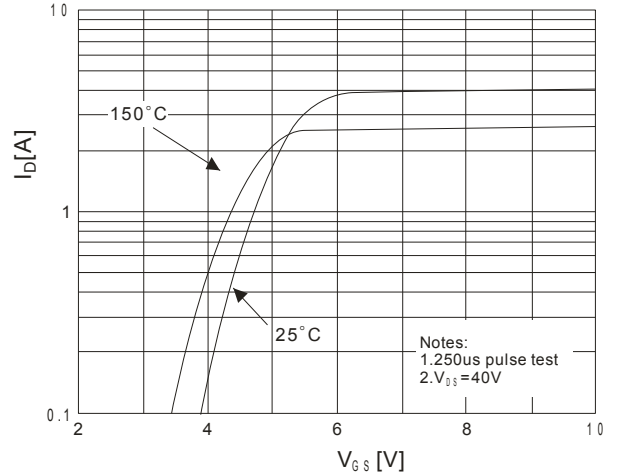

Fig.2 Transfer characteristics

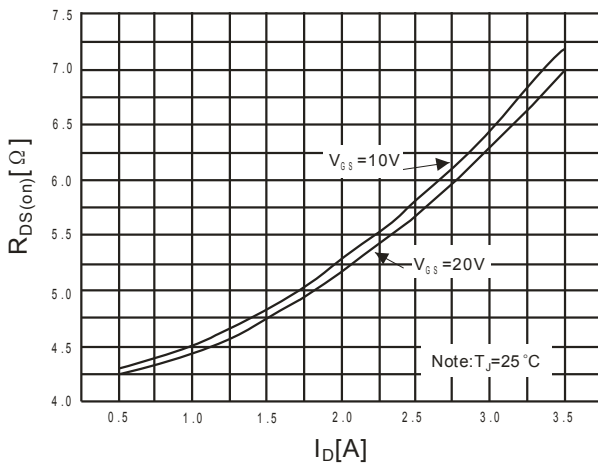

Fig.3 On Resistance variation vs Drain Current and Gate Voltage

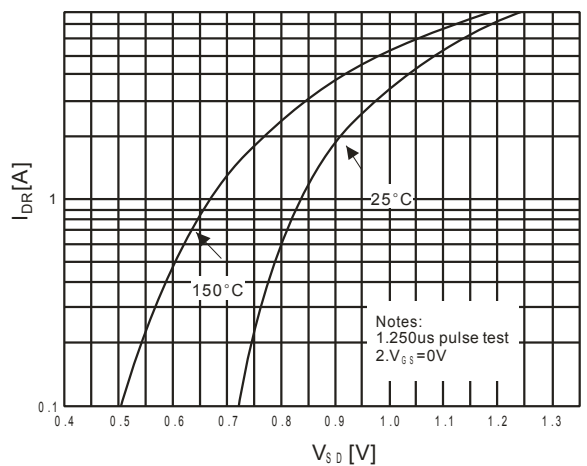

Fig.4 Body Diode Forward Voltage Variation With Source Current And temperature

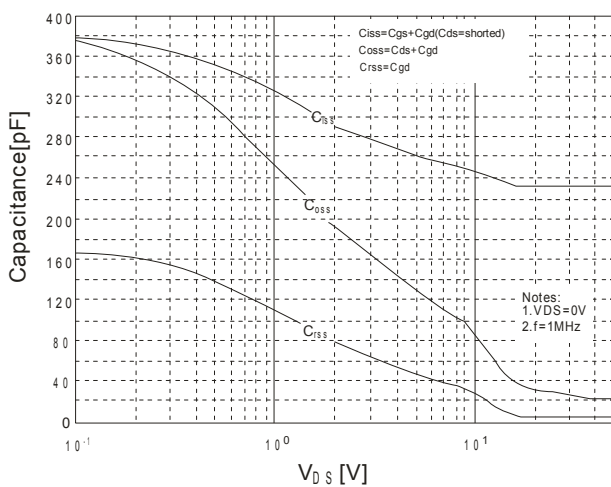

Fig.5 Capacitance Characteristics

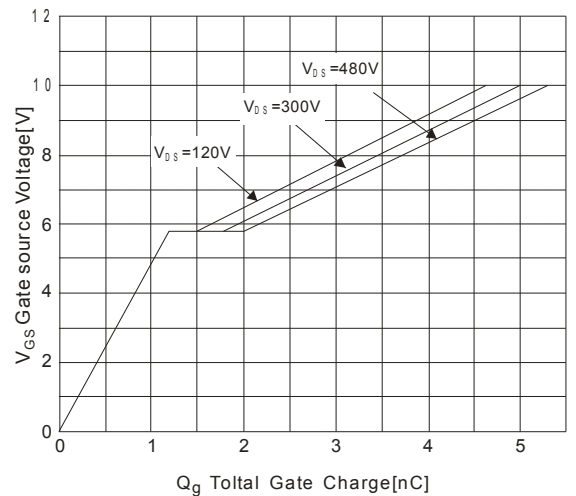

Fig.6 Gate Charge Characteristics

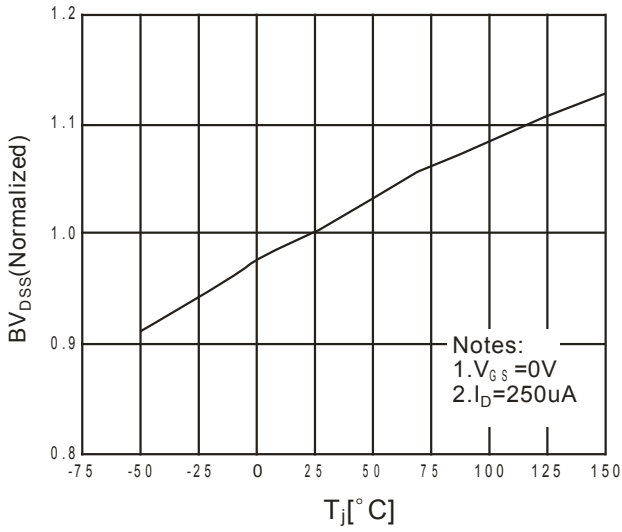

Fig.7 Breakdown Voltage Variation Vs, Temperature

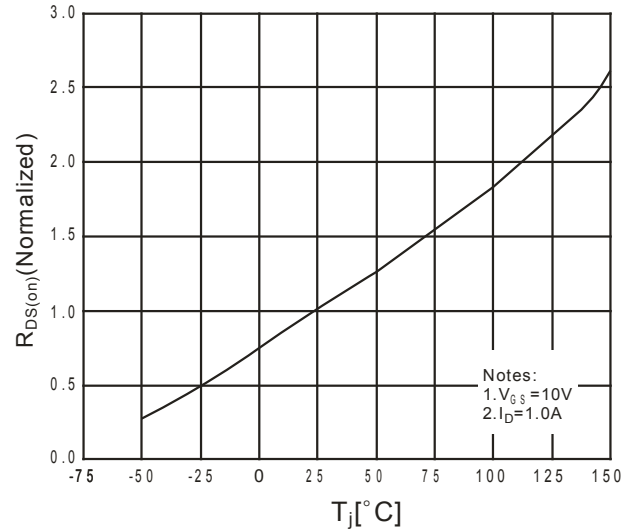

Fig.8 On-Resistance Variation vs. temperature

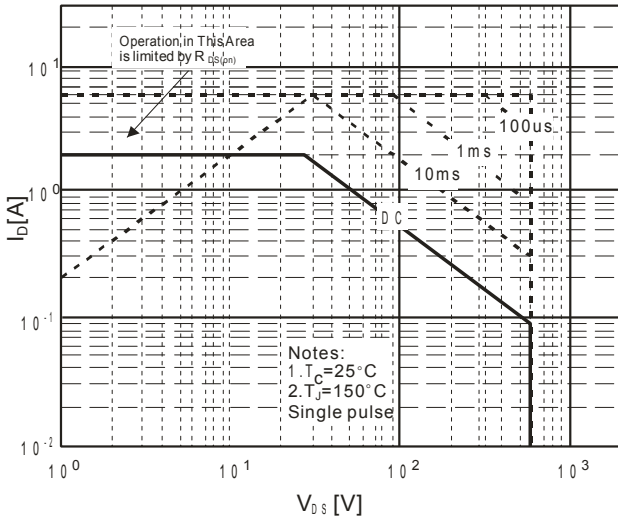

Fig.9 Maximum Safe Operation Area

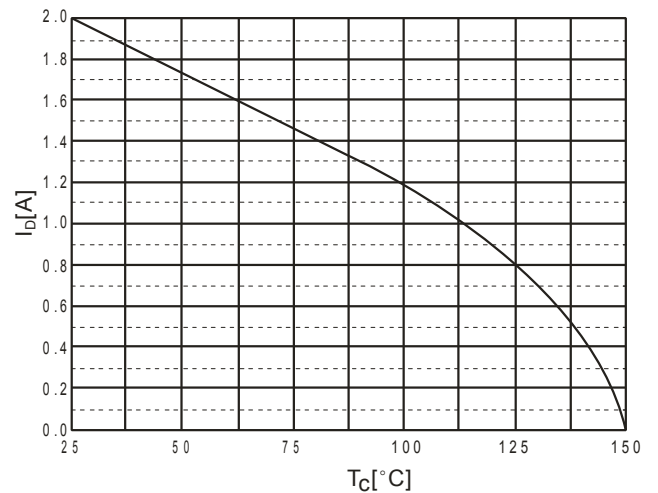

Fig.10 Maximum Drain Current vs Case Temperature

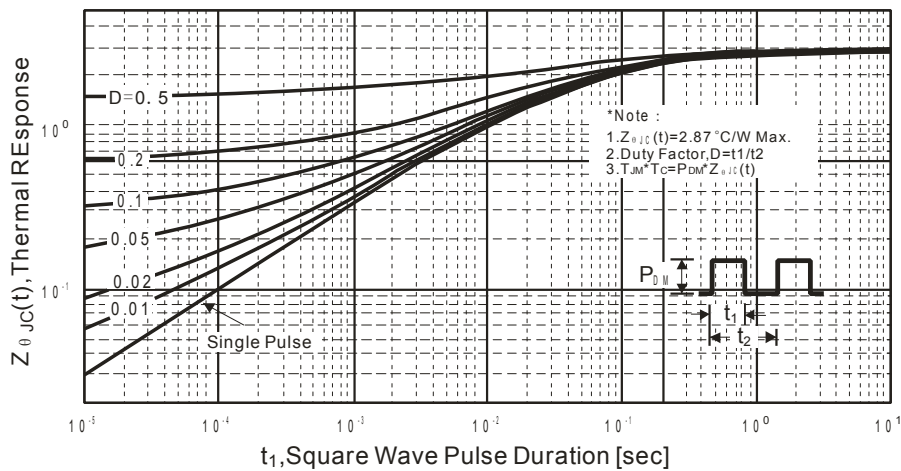

Fig.11 Transient Thermal Response curve

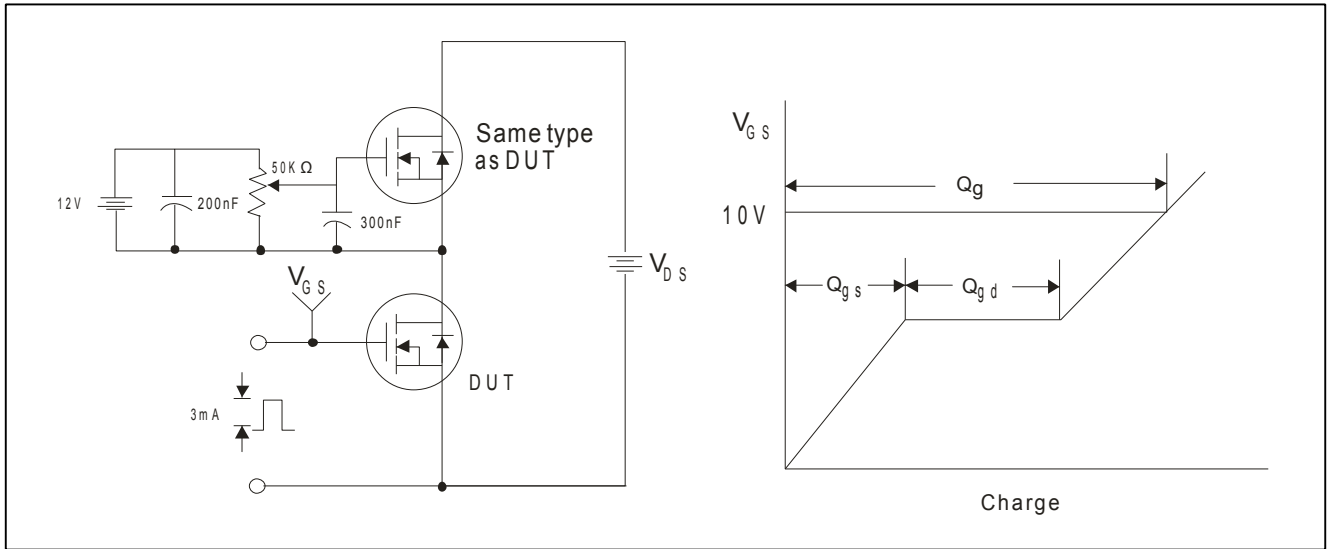

Fig.12 Gate Test Circuit & Waveform

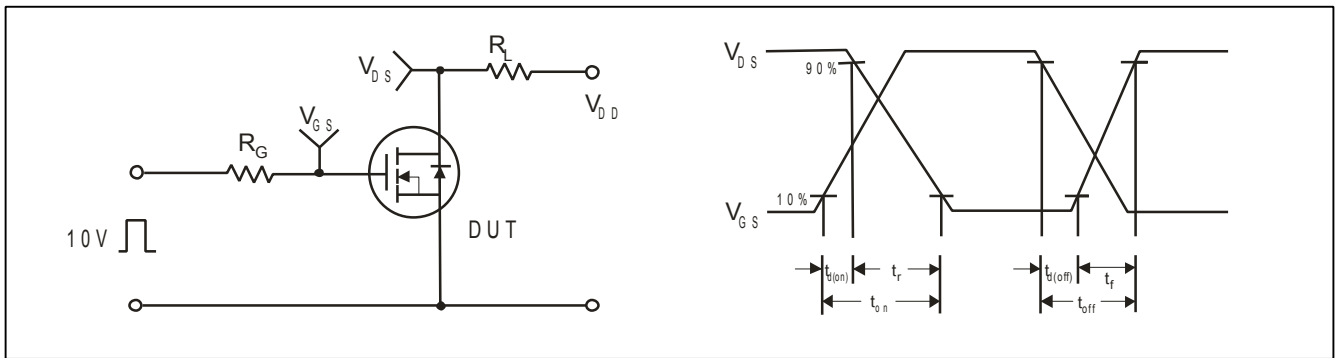

Fig.13 Resistive Switching Test Circuit & Waveform

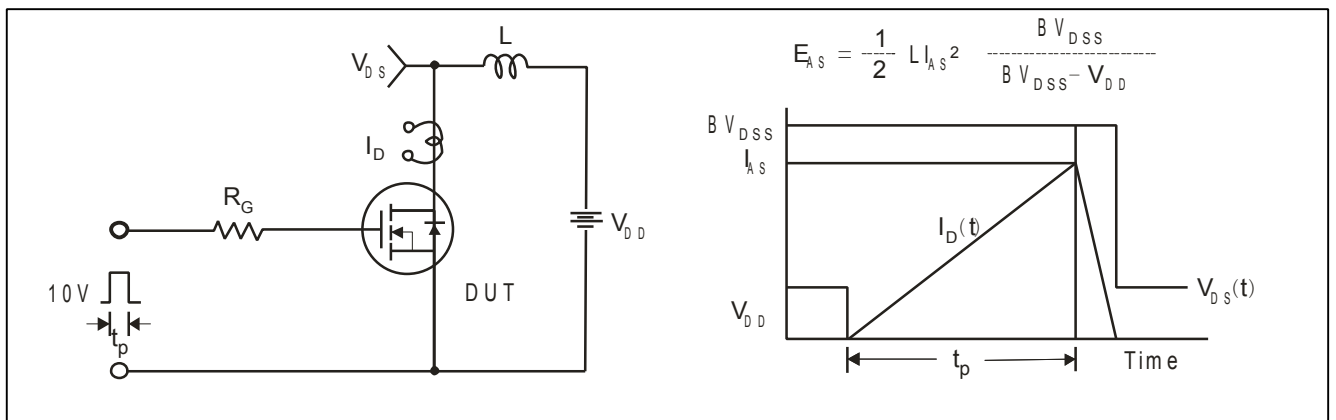

Fig.14 Unclamped Inductive Switching Test Circuit & Waveform

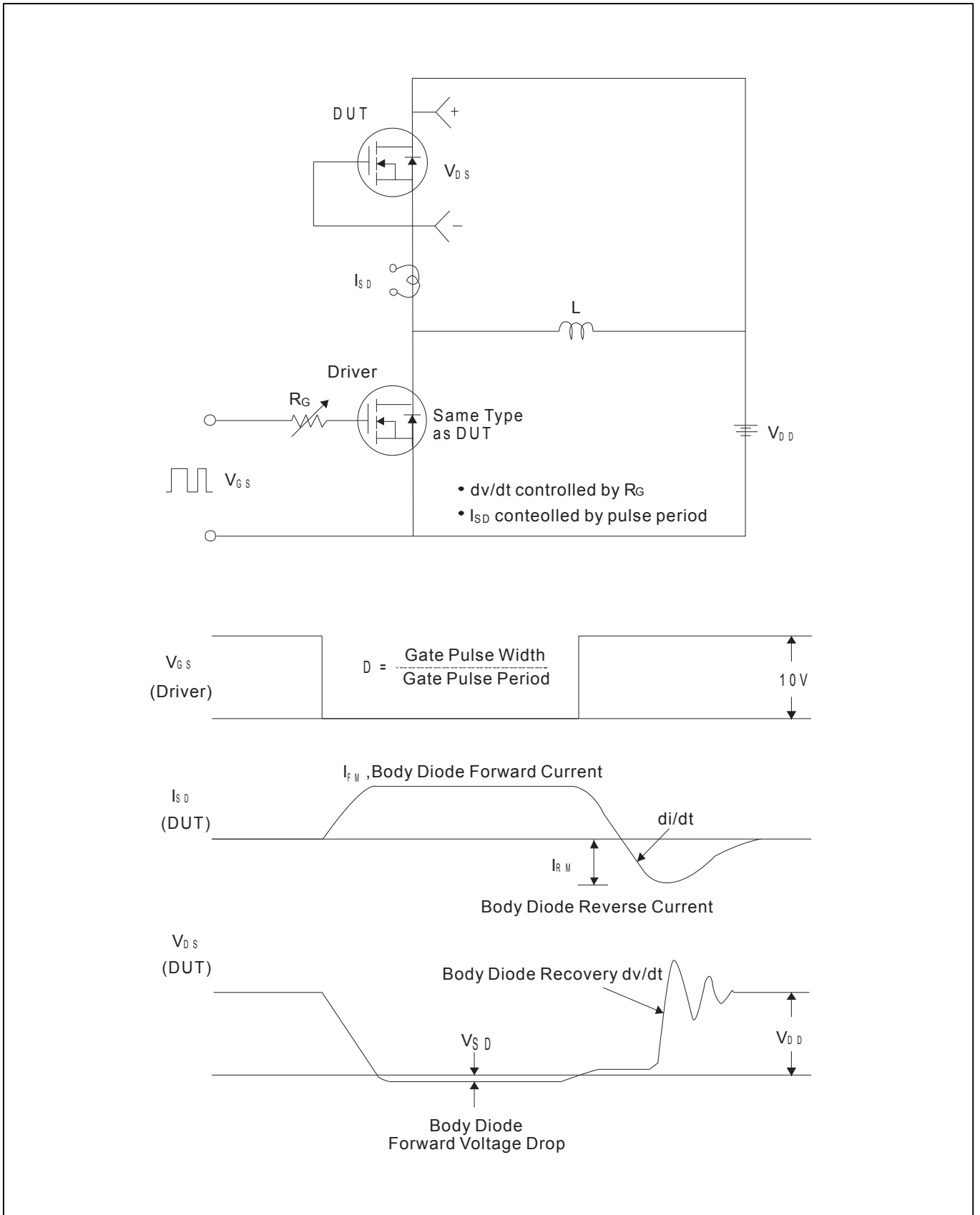
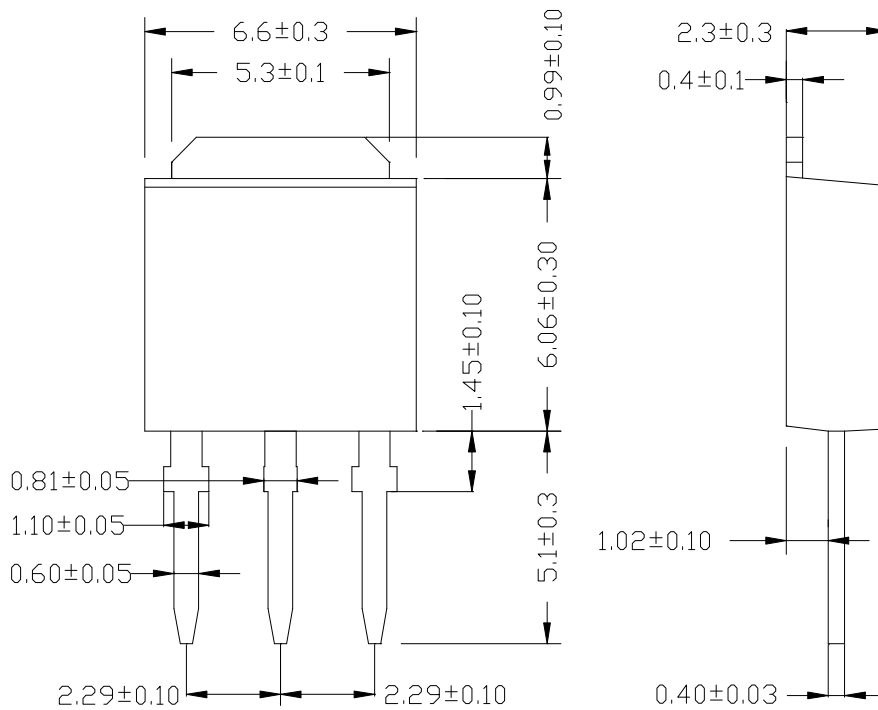

Fig.15 Peak Diode Recovery dv/dt Test Circuit & Waveform

TO-251 Package Dimension

Unit: mm



NOTE:

- 1.We strongly recommend customers check carefully on the trademark when buying our product, if there is any question, please don't be hesitate to contact us.
- 2.Please do not exceed the absolute maximum ratings of the device when circuit designing.
- 3.Winsemi Microelectronics Co., Ltd reserved the right to make changes in this specification sheet and is subject to change without prior notice.

CONTACT:

Winsemi Microelectronics Co., Ltd.

ADD:Futian District, ShenZhen Tian An Cyber Tech Plaza two East Wing 1002

Post Code : 518040

Tel : +86-755-8250 6288

FAX : +86-755-8250 6299

Web Site : www.winsemi.com