

Silicon N-Channel MOSFET

Features

- 5A,500V,RDS(on)(Max1.6Ω)@VGS=10V
- Ultra-low Gate Charge(Typical 32nC)
- Fast Switching Capability
- 100%Avalanche Tested
- Maximum Junction Temperature Range(150°C)

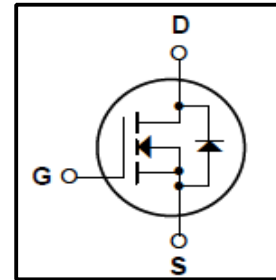

General Description

This Power MOSFET is produced using Winsemi's advanced planar stripe, DMOS technology. This latest technology has been especially designed to minimize on-state resistance, have a high rugged avalanche characteristics. This devices is specially well suited for high efficiency switch model power supplies, power factor correction and half bridge and full bridge resonant topology line a electronic lamp ballast.

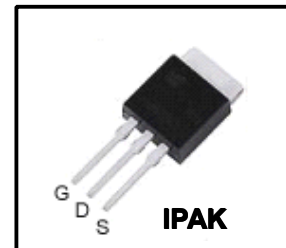

Absolute Maximum Ratings

Symbol	Parameter	Value	Units
V _{DSS}	Drain Source Voltage	500	V
I _D	Continuous Drain Current(@Tc=25°C)	5	A
	Continuous Drain Current(@Tc=100°C)	2.9	A
I _{DM}	Drain Current Pulsed (Note1)	18	A
V _{GS}	Gate to Source Voltage	±30	V
E _{AS}	Single Pulsed Avalanche Energy (Note 2)	300	mJ
E _{AR}	Repetitive Avalanche Energy (Note 1)	7.5	mJ
dv/dt	Peak Diode Recovery dv/dt (Note 3)	4.5	V/ns
P _D	Total Power Dissipation(@Tc=25°C)	61	W
	Derating Factor above 25°C	0.49	W/°C
T _J , T _{stg}	Junction and Storage Temperature	-55~150	°C
T _L	Channel Temperature	300	°C

Thermal Characteristics

Symbol	Parameter	Value			Units
		Min	Typ	Max	
R _{QJC}	Thermal Resistance, Junction-to-Case	-	-	2.05	°C/W
R _{QCS}	Thermal Resistance, Case-to-Sink	-	0.5	-	°C/W
R _{QJA}	Thermal Resistance, Junction-to-Ambient	-	-	62.5	°C/W

Electrical Characteristics (Tc = 25°C)

Characteristics	Symbol	Test Condition	Min	Type	Max	Unit	
Gate leakage current	I _{GSS}	V _{GS} = ±30 V, V _{DS} = 0 V	-	-	±100	nA	
Gate-source breakdown voltage	V _{(BR)GSS}	I _G = ±10 μA, V _{DS} = 0 V	±30	-	-	V	
Drain cut-off current	I _{DSS}	V _{DS} = 500 V, V _{GS} = 0 V	-	-	1	μA	
Drain-source breakdown voltage	V _{(BR)DSS}	I _D = 250 μA, V _{GS} = 0 V	500	-	-	V	
Break Voltage Temperature Coefficient	$\frac{\Delta BV_{DSS}}{\Delta T_J}$	I _D =250μA, Referenced to 25°C	-	0.55	-	V/°C	
Gate threshold voltage	V _{GS(th)}	V _{DS} = 10 V, I _D =250 μA	3	-	4.5	V	
Drain-source ON resistance	R _{DS(ON)}	V _{GS} = 10 V, I _D = 2.25A	-	1.16	1.6	Ω	
Forward Transconductance	g _{fs}	V _{DS} = 40 V, I _D = 2.25A	-	4.2	-	S	
Input capacitance	C _{iss}	V _{DS} = 25 V,	-	800	1050	pF	
Reverse transfer capacitance	C _{rss}	V _{GS} = 0 V,	-	16	21		
Output capacitance	C _{oss}	f = 1 MHz	-	76	100		
Switching time	Rise time	t _r	V _{DD} =250 V, I _D =4.5A R _G =25Ω (Note4,5)	-	15	40	ns
	Turn-on time	t _{on}		-	40	90	
	Fall time	t _f		-	85	180	
	Turn-off time	t _{off}		-	45	100	
Total gate charge (gate-source plus gate-drain)	Q _g	V _{DD} = 400 V, V _{GS} = 10 V, I _D =5 A (Note4,5)	-	32	44	nC	
Gate-source charge	Q _{gs}		-	3.7	-		
Gate-drain ("miller") Charge	Q _{gd}		-	15	-		

Source-Drain Ratings and Characteristics (Ta = 25°C)

Characteristics	Symbol	Test Condition	Min	Type	Max	Unit
Continuous drain reverse current	I _{DR}	-	-	-	5	A
Pulse drain reverse current	I _{DRP}	-	-	-	18	A
Forward voltage (diode)	V _{DSF}	I _{DR} =5A, V _{GS} = 0 V	-	-	1.4	V
Reverse recovery time	t _{rr}	I _{DR} =5A, V _{GS} = 0 V, dI _{DR} / dt = 100 A / μs	-	305	-	ns
Reverse recovery charge	Q _{rr}		-	2.6	-	μC

Note 1.Repeativity rating :pulse width limited by junction temperature

2.L=24mH,I_{AS}=5A,V_{DD}=50V,R_G=25Ω,Starting T_J=25°C

3.I_{SD}≤5A,di/dt≤300A/us, V_{DD}<BV_{DSS},STARTING T_J=25°C

4.Pulse Test: Pulse Width≤300us,Duty Cycle≤2%

5.Essentially independent of operating temperature.

This transistor is an electrostatic sensitive device

Please handle with caution

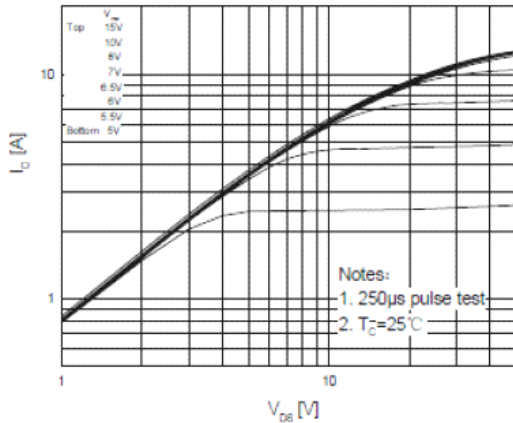

Fig. 1 On-State Characteristics

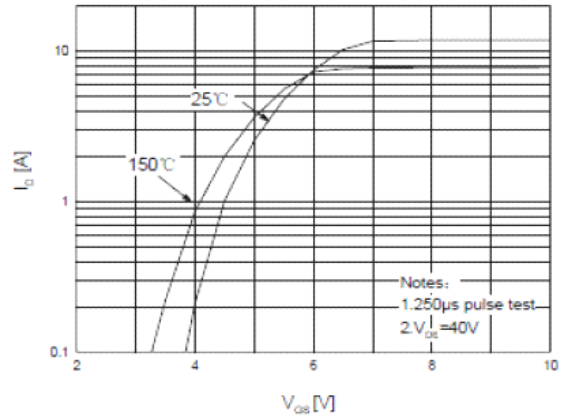

Fig. 2 Transfer Characteristics

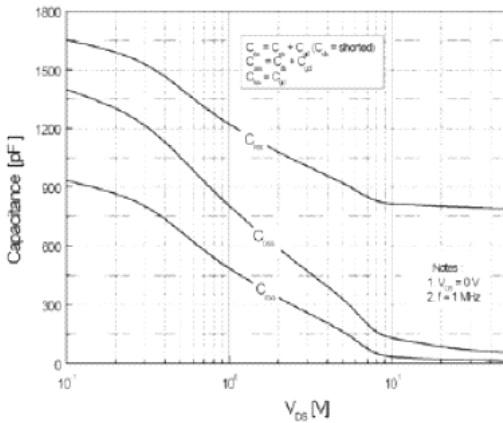

Fig. 3 Capacitance Variation vs Drain Voltage

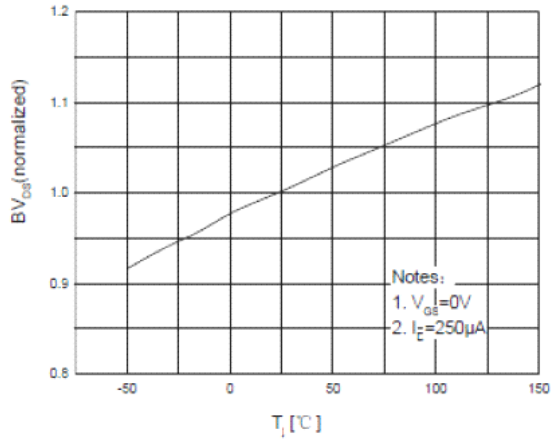

Fig. 4 Breakdown Voltage Variation vs Temperature

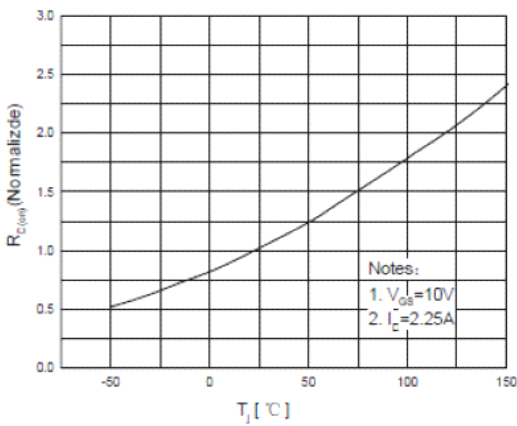

Fig. 5 On-Resistance Variation vs Junction Temperature

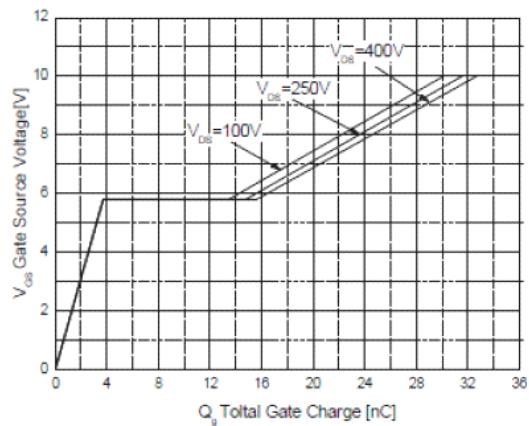

Fig. 6 Gate Charge Characteristics

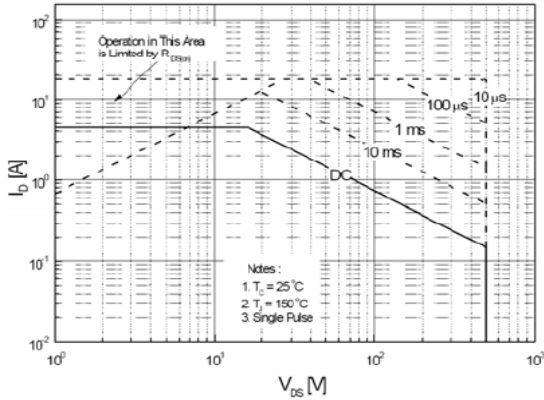

Fig.7 Maximum Safe Operation Area

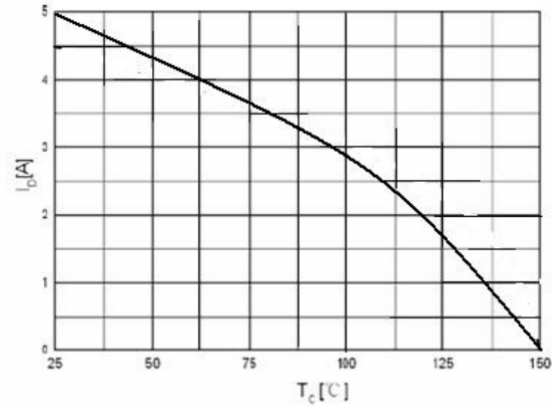

Fig.8 Maximum Drain Current vs Case Temperature

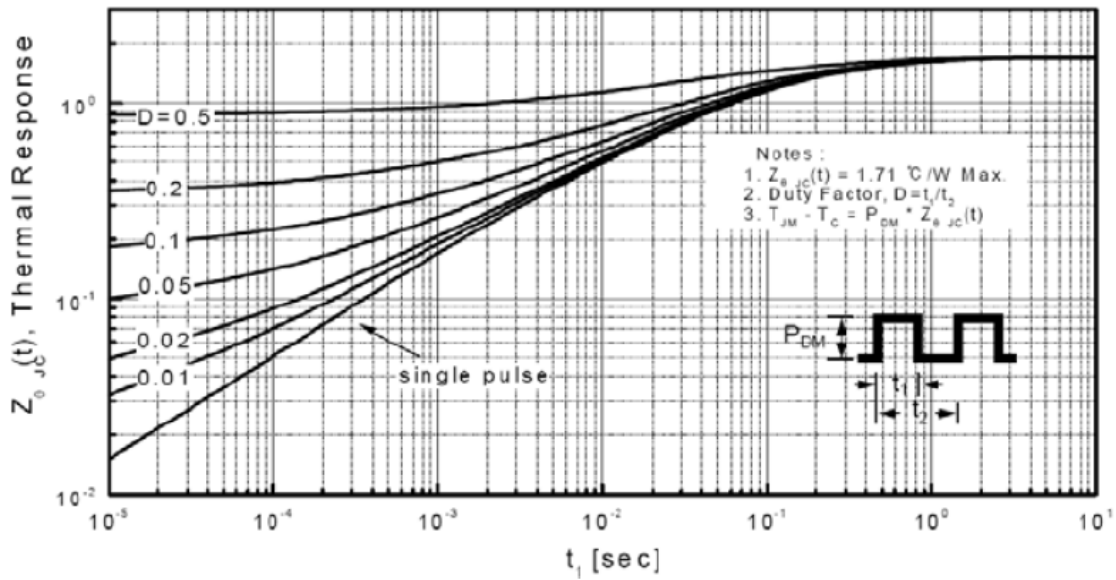

Fig.9 Transient Thermal Response Curve

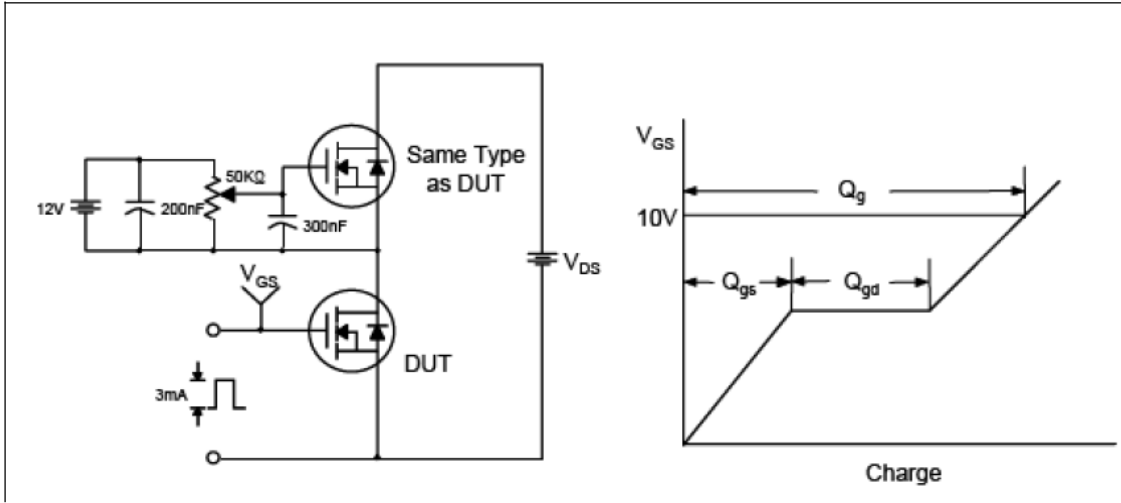

Fig.10 Gate Test Circuit & Waveform

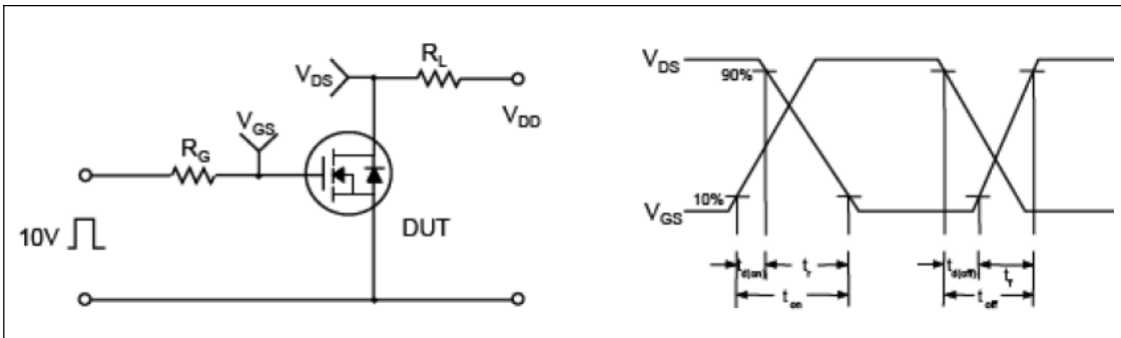

Fig.11 Resistive Switching Test Circuit & Waveform

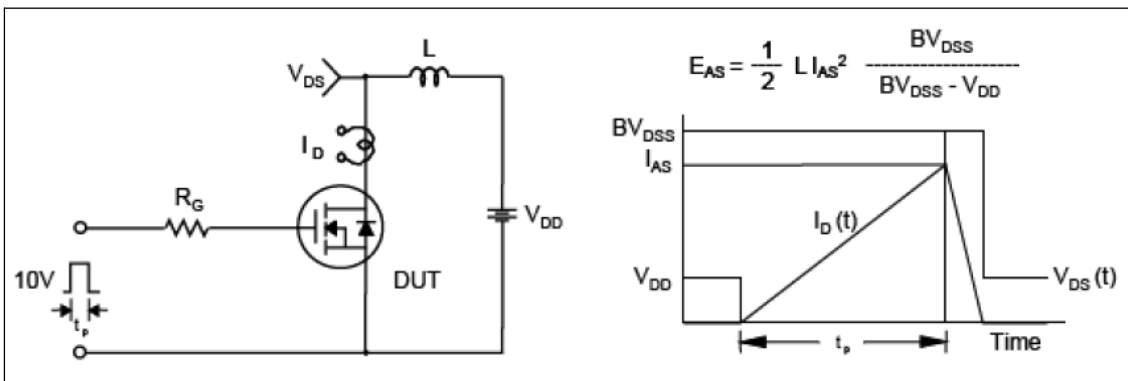

Fig.12 Unclamped Inductive Switching Test Circuit & Waveform

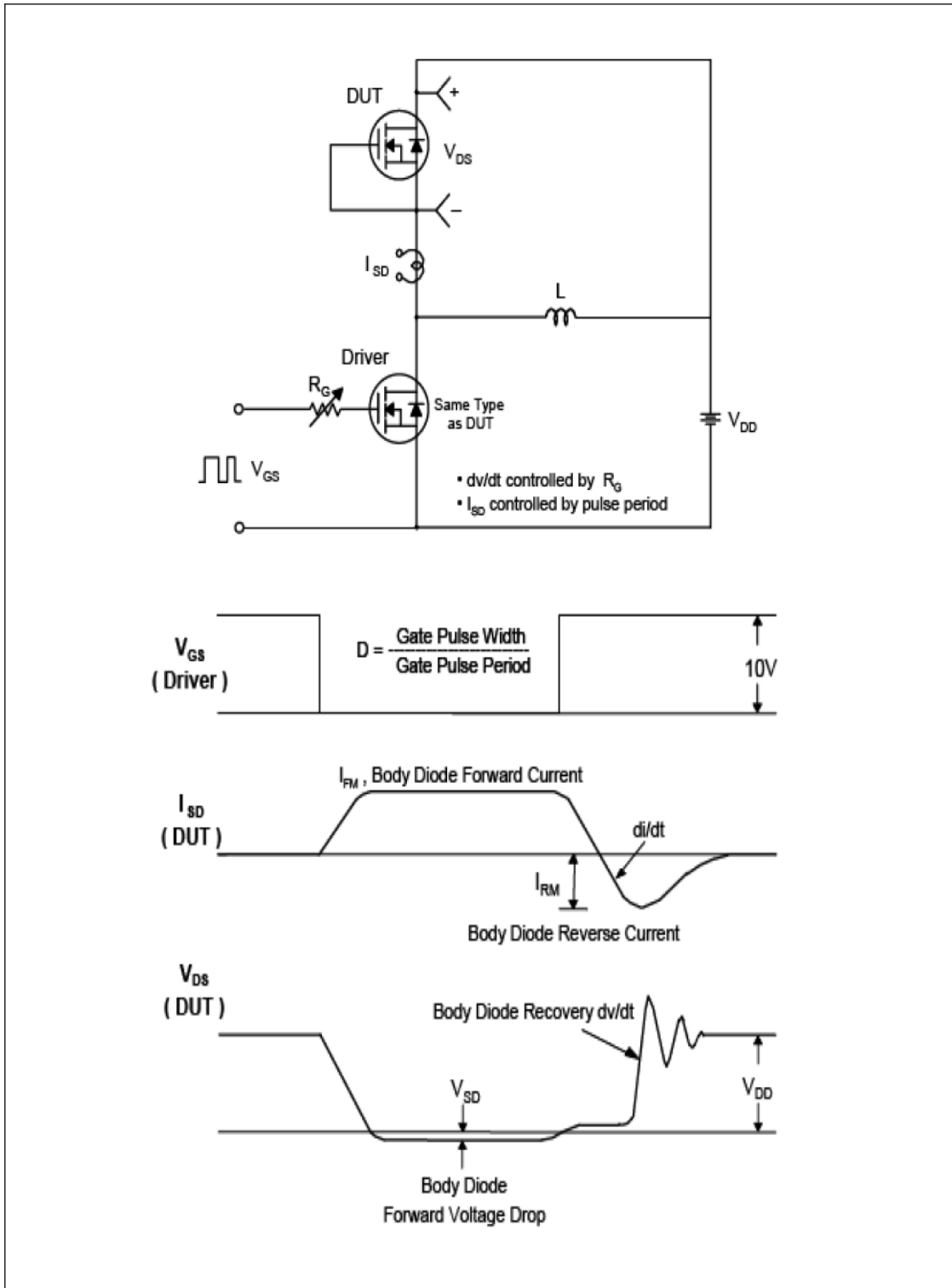

Fig.13 Peak Diode Recovery dv/dt Test Circuit & Waveform

IPAK Package Dimension

