



### Features

- Switching** Zero cross
- Output** Back to back SCR with internal snubber
- Input** DC with constant current control
- Applications** Resistive and inductive loads with  $\cos\phi > 0.85$

### Technical data

WG 280 D...	10 Z	25 Z	45 Z	50 Z
<b>Input circuit</b>				
Control voltage range	3...32 VDC			
Control current max.	12 mA			
Turn-off voltage min.	1 VDC			
Input resistance	constant current			
<b>Output circuit</b>				
Load voltage range	24...280 VAC			
Peak-off state voltage	600 V <sub>drm</sub>			
Off-state leakage current	6 mA eff.		12 mA eff.	
Load current range	0,1...10 A	0,2...25 A	0,4...45 A	0,4...50 A
Surge current 1 half wave	110 A <sub>peak</sub>	230 A <sub>peak</sub>	500 A <sub>peak</sub>	570 A <sub>peak</sub>
I <sup>2</sup> t for fusing	60 A <sup>2</sup> s	260 A <sup>2</sup> s	1250 A <sup>2</sup> s	1620 A <sup>2</sup> s
On-state voltage	1,6 V <sub>peak</sub>			
Off-state (static) dV/dt	500 V/μs			
Snubber	47 Ω / 47 nF		47 Ω / 100 nF	
<b>General data</b>				
Turn-on time max.	11 ms			
Turn-off time max.	11 ms			
Line frequency range	47...63 Hz			
Isolation volt. between input/output	4.000 V			
Isolation volt. between input-output/base	2.500 V			
Isolation resistance	50 MΩ			
Operation temperature	-20...+80 °C			
Recommended varistor	SIOV-S20 K230			
Approvals	UL, VDE			

### Technical data

WG 280 D...	75 Z	90 Z	110 Z	125 Z
<b>Input circuit</b>				
Control voltage range	3...32 VDC			
Control current max.	12 mA			
Turn-off voltage min.	1 VDC			
Input resistance	constant current			
<b>Output circuit</b>				
Load voltage range	24...280 VAC			
Peak-off state voltage	600 V <sub>drm</sub>			
Off-state leakage current	12 mA eff.			
Load current range	0,4...75 A	0,4...90 A	0,4...110 A	0,4...125 A
Surge current 1 half wave	910 A <sub>peak</sub>	1090 A <sub>peak</sub>	1350 A <sub>peak</sub>	1590 A <sub>peak</sub>
I <sup>2</sup> t for fusing	4150 A <sup>2</sup> s	5980 A <sup>2</sup> s	9100 A <sup>2</sup> s	12650 A <sup>2</sup> s
On-state voltage	1,6 V <sub>peak</sub>			
Off-state (static) dV/dt	500 V/μs			
Snubber	47 Ω / 100 nF			
<b>General data</b>				
Turn-on time max.	11 ms			
Turn-off time max.	11 ms			
Line frequency range	47...63 Hz			
Isolation volt. between input/output	4.000 V			
Isolation volt. between input-output/base	2.500 V			
Isolation resistance	50 MΩ			
Operation temperature	-20...+80 °C			
Recommended varistor	SIOV-S20 K230			
Approvals	UL, VDE			

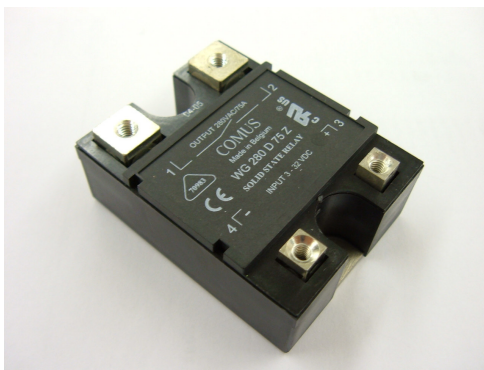

### Features

<b>Switching</b>	Random
<b>Output</b>	Back to back SCR with internal snubber
<b>Input</b>	DC with constant current control
<b>Applications</b>	Inductive loads

### Technical data

WG 280 D...	10 R	25 R	40 R	50 R
<b>Input circuit</b>				
Control voltage range	3...32 VDC			
Control current max.	12 mA			
Turn-off voltage min.	1 VDC			
Input resistance	constant current			
<b>Output circuit</b>				
Load voltage range	24...280 VAC			
Peak-off state voltage	600 V <sub>drm</sub>			
Off-state leakage current	6 mA eff.		12 mA eff	
Load current range	0,1...10 A	0,2...25 A	0,4...40 A	0,4...50 A
Surge current 1 half wave	110 A <sub>peak</sub>	230 A <sub>peak</sub>	500 A <sub>peak</sub>	570 A <sub>peak</sub>
I <sup>2</sup> t for fusing	60 A <sup>2</sup> s	260 A <sup>2</sup> s	1250 A <sup>2</sup> s	1620 A <sup>2</sup> s
On-state voltage	1,6 V <sub>peak</sub>			
Off-state (static) dV/dt	500 V/μs			
Snubber	47 Ω / 47 nF		47 Ω / 100 nF	
<b>General data</b>				
Turn-on time max.	0,1 ms			
Turn-off time max.	11 ms			
Line frequency range	47...63 Hz			
Isolation volt. between input/output	4.000 V			
Isolation volt. between input-output/base	2.500 V			
Isolation resistance	50 MΩ			
Operation temperature	-20...+80 °C			
Recommended varistor	SIOV-S20 K230			
Approvals	UL, VDE			

### Technical data

WG 280 D...	75 R	90 R	110 R	125 R
<b>Input circuit</b>				
Control voltage range	3...32 VDC			
Control current max.	12 mA			
Turn-off voltage min.	1 VDC			
Input resistance	constant current			
<b>Output circuit</b>				
Load voltage range	24...280 VAC			
Peak-off state voltage	600 V <sub>drm</sub>			
Off-state leakage current	12 mA eff.			
Load current range	0,4...75 A	0,4...90 A	0,4...110 A	0,4...125 A
Surge current 1 half wave	910 A <sub>peak</sub>	1090 A <sub>peak</sub>	1350 A <sub>peak</sub>	1590 A <sub>peak</sub>
I <sup>2</sup> t for fusing	4150 A <sup>2</sup> s	5980 A <sup>2</sup> s	9100 A <sup>2</sup> s	12650 A <sup>2</sup> s
On-state voltage	1,6 V <sub>peak</sub>			
Off-state (static) dV/dt	500 V/μs			
Snubber	47 Ω / 100 nF			
<b>General data</b>				
Turn-on time max.	0,1 ms			
Turn-off time max.	11 ms			
Line frequency range	47...63 Hz			
Isolation volt. between input/output	4.000 V			
Isolation volt. between input-output/base	2.500 V			
Isolation resistance	50 MΩ			
Operation temperature	-20...+80 °C			
Recommended varistor	SIOV-S20 K230			
Approvals	UL, VDE			

### Dimensions in mm & circuit diagram

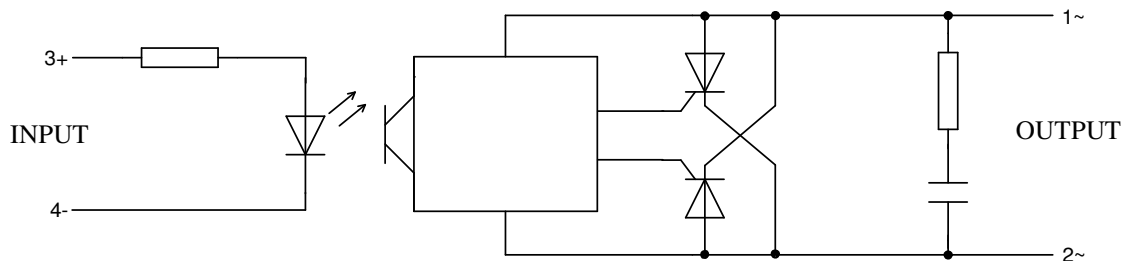
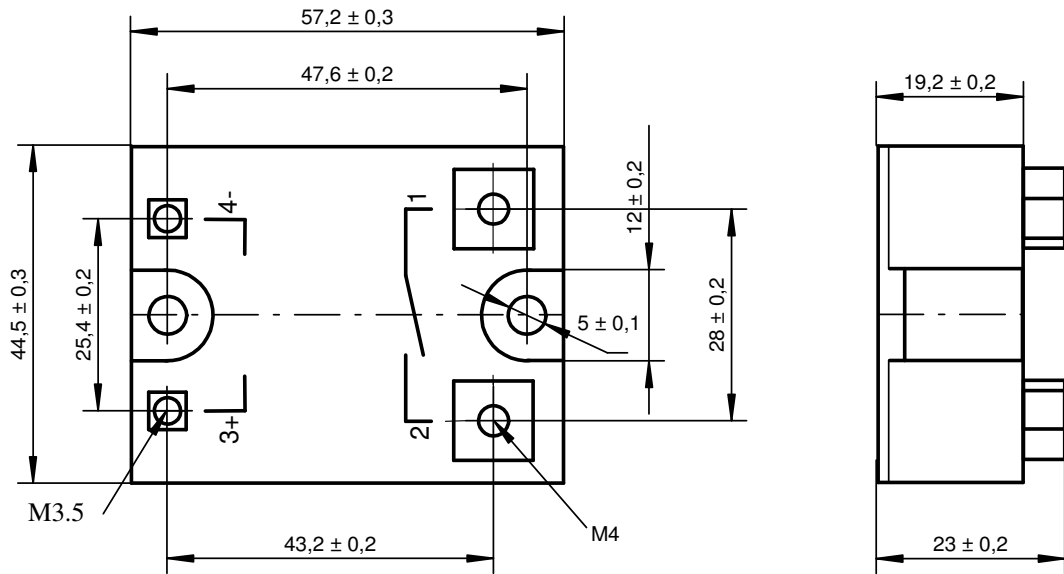

### Housing specification

Weight	Approx. 80 gr unpotted , 100 gr potted (optional)
Housing material	Glass filled polyester
Potting compound (optional)	UL recognized Epoxy
Base plate	10 ... 45 A : Aluminium 50 ... 125A : Aluminium , nickel plated
Terminals	Input : M4-screws Output : M3,5-screws

### Derating-diagrams

UL recognised components: suitable for a max. surrounding air temperature of 40°C.  
 For use at other ambient temperatures, check the derating diagrams.

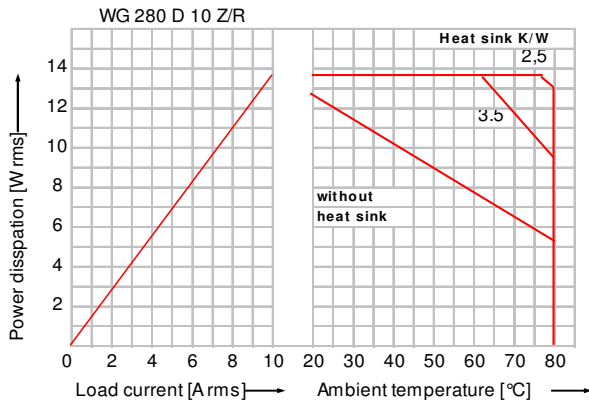

**Number of SSR per heatsink/  
load current per SSR**

Heat sink	1 SSR	2 SSR	3 SSR
WG K1/100	10 A	8 A	
WG K2/100	10 A	10 A	
WG K3/160	10 A	10 A	10 A
WG K4/160L	10 A	10 A	10 A
WG K5/80	10 A		

Values for 40°C enclosure-temperature and mounted with conduction paste between the SSR and the heat sink

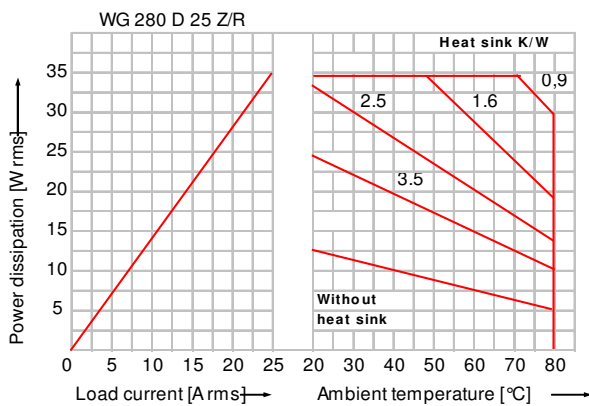

**Number of SSR per heatsink/  
load current per SSR**

Heat sink	1 SSR	2 SSR	3 SSR
WG K1/100	13 A	8 A	
WG K2/100	19 A	12 A	
WG K3/160	25 A	25 A	19 A
WG K4/160L	25 A	25 A	25 A
WG K5/80	24 A		

Values for 40°C enclosure-temperature and mounted with conduction paste between the SSR and the heat sink

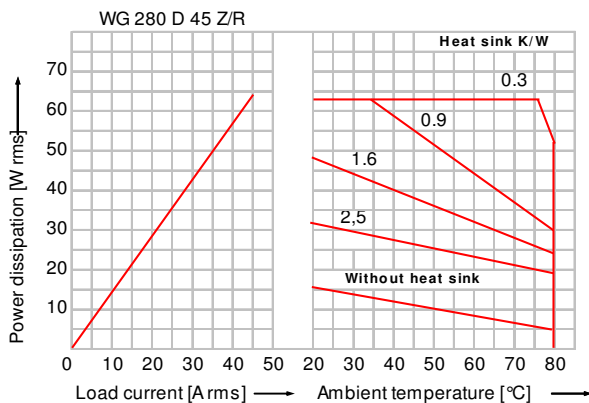

**Number of SSR per heatsink/  
load current per SSR**

Heat sink	1 SSR	2 SSR	3 SSR
WG K1/100	13 A	8 A	
WG K2/100	19 A	12 A	
WG K3/160	42 A	26 A	19 A
WG K4/160L	45 A	45 A	40 A
WG K5/80	24 A		

Values for 40°C enclosure-temperature and mounted with conduction paste between the SSR and the heat sink

### Derating-diagrams

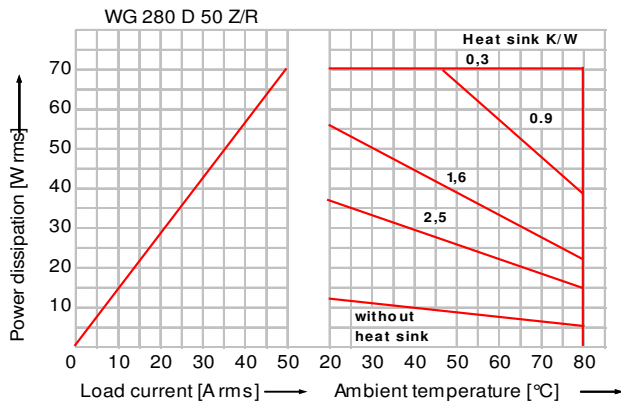

#### Number of SSR per heatsink/ load current per SSR

Heat sink	1 SSR	2 SSR	3 SSR
WG K1/100	13 A	8 A	
WG K2/100	20 A	12 A	
WG K3/160	50 A	31 A	20 A
WG K4/160L	50 A	50 A	50 A
WG K5/80	25A		

Values for 40°C enclosure-temperature and mounted with conduction paste between the SSR and the heat sink

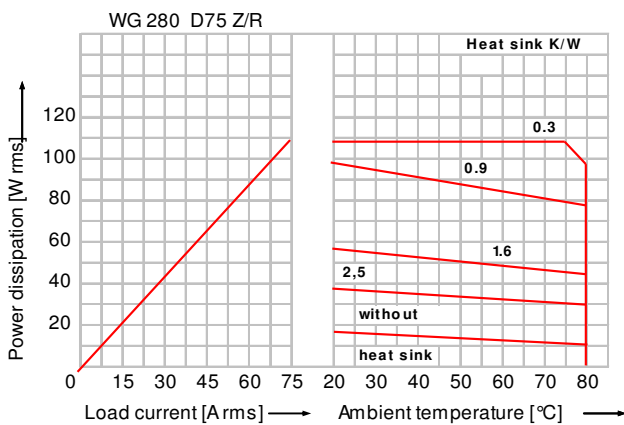

#### Number of SSR per heatsink/ load current per SSR

Heat sink	1 SSR	2 SSR	3 SSR
WG K1/100	13 A	8 A	
WG K2/100	20 A	12 A	
WG K3/160	55 A	32 A	20 A
WG K4/160L	75 A	75 A	57 A
WG K5/80	25 A		

Values for 40°C enclosure-temperature and mounted with conduction paste between the SSR and the heat sink

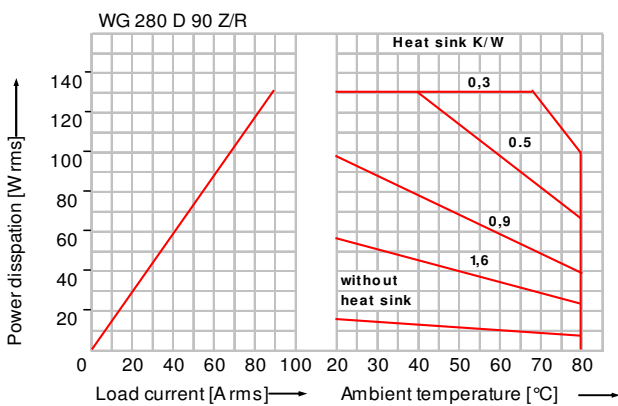

#### Number of SSR per heatsink/ load current per SSR

Heat sink	1 SSR	2 SSR	3 SSR
WG K1/100	13 A	8 A	
WG K2/100	20 A	12 A	
WG K3/160	55 A	32 A	20 A
WG K4/160L	90 A	90 A	57 A
WG K5/80	25 A		

Values for 40°C enclosure-temperature and mounted with conduction paste between the SSR and the heat sink

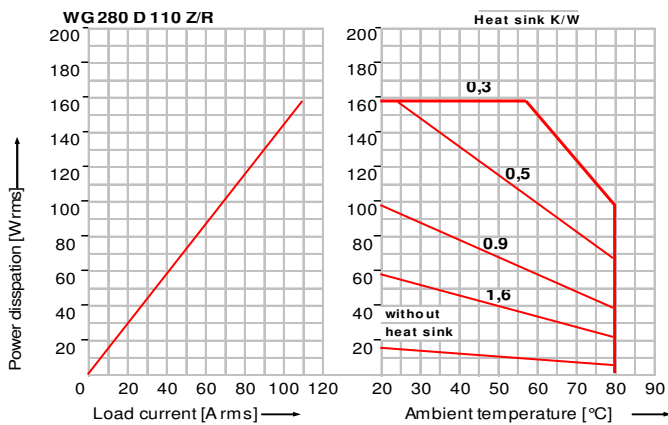

**Number of SSR per heatsink/  
load current per SSR**

Heat sink	1 SSR	2 SSR
WG K1/100	13 A	8 A
WG K2/100	21 A	12 A
WG K3/160	58 A	33 A
WG K4/160L	110 A	85 A
WG K5/80	34 A	

Values for 40°C enclosure-temperature and mounted with conduction paste between the SSR and the heat sink

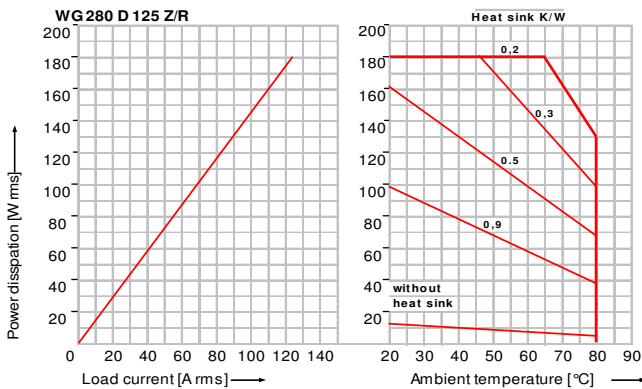

**Number of SSR per heatsink/  
load current per SSR**

Heat sink	1 SSR	2 SSR
WG K1/100	13 A	8 A
WG K2/100	21 A	12 A
WG K3/160	58 A	33 A
WG K4/160L	125 A	85 A
WG K5/80	34 A	

Values for 40°C enclosure-temperature and mounted with conduction paste between the SSR and the heat sink

### Ordering

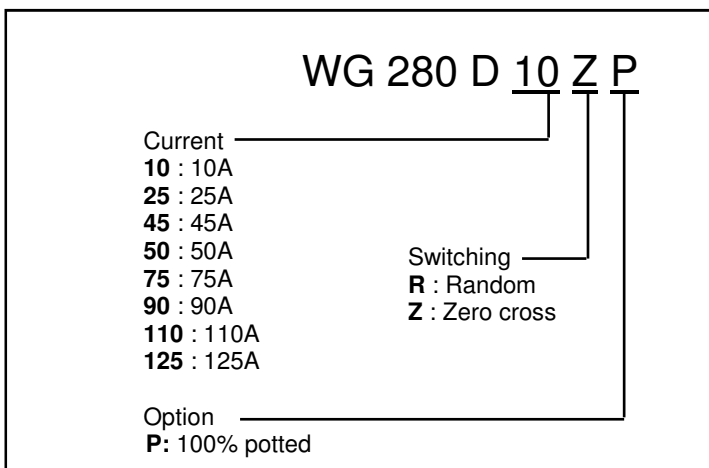

Description	Part Number
Protective case small	8440 5700 110
Thermal Conducting paste	8406 0180 020
Heat sink WG K1/100	5981 5701 100
Heat sink WG K2/100	5981 5701 110
Heat sink WG K3/160	5981 5701 370
Heat sink WG K4/160L	5981 5701 371
Heat sink WG K5/80	5981 5701 372
Mounting plate DIN rail	5981 5701 430



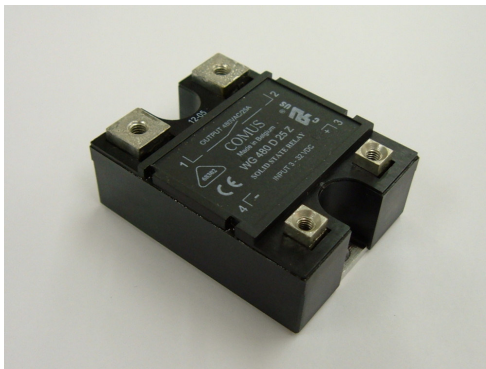

### Features

- Switching** Zero cross
- Output** Back to back SCR with internal snubber
- Input** DC with constant current control
- Applications** Resistive and inductive loads with  $\cos\phi > 0.85$

### Technical data

WG 480 D...	10 Z	25 Z	40 Z	50 Z
<b>Input circuit</b>				
Control voltage range	3...32 VDC			
Control current max.	22 mA			
Turn-off voltage min.	1 VDC			
Input resistance	constant current			
<b>Output circuit</b>				
Load voltage range	24...530 VAC			
Peak-off state voltage	1200 V <sub>drm</sub> (integrated overvoltage protection effective above 1000V)			
Off-state leakage current	10 mA eff.			
Load current range	0,1...10 A	0,2...25 A	0,4...40 A	0,4...50 A
Surge current 1 half wave	110 A <sub>peak</sub>	230 A <sub>peak</sub>	500 A <sub>peak</sub>	570 A <sub>peak</sub>
I <sup>2</sup> t for fusing	60 A <sup>2</sup> s	260 A <sup>2</sup> s	1250 A <sup>2</sup> s	1620 A <sup>2</sup> s
On-state voltage	1,6 V <sub>peak</sub>			
Off-state (static) dV/dt	500 V/μs			
Snubber	47 Ω / 22 nF			
<b>General data</b>				
Turn-on time max.	11 ms			
Turn-off time max.	11 ms			
Line frequency range	47...63 Hz			
Isolation volt. between input/output	4.000 V			
Isolation volt. between input-output/base	2.500 V			
Isolation resistance	50 MΩ			
Operation temperature	-20...+80 °C			
Recommended varistor	SIOV-S20 K420			
Approvals	UL, VDE			

### Technical data

WG 480 D...	75 Z	90 Z	110 Z	125 Z
<b>Input circuit</b>				
Control voltage range	3...32 VDC			
Control current max.	22 mA			
Turn-off voltage min.	1 VDC			
Input resistance	constant current			
<b>Output circuit</b>				
Load voltage range	24...530 VAC			
Peak-off state voltage	1200 V <sub>drm</sub> (integrated overvoltage protection effective above 1000V)			
Off-state leakage current	10 mA eff.			
Load current range	0,4...75 A	0,4...90 A	0,4...110 A	0,4...125 A
Surge current 1 half wave	910 A <sub>peak</sub>	1090 A <sub>peak</sub>	1350 A <sub>peak</sub>	1590 A <sub>peak</sub>
I <sup>2</sup> t for fusing	4150 A <sup>2</sup> s	5980 A <sup>2</sup> s	9100 A <sup>2</sup> s	12650 A <sup>2</sup> s
On-state voltage	1,6 V <sub>peak</sub>			
Off-state (static) dV/dt	500 V/μs			
Snubber	47 Ω / 22 nF			
<b>General data</b>				
Turn-on time max.	11 ms			
Turn-off time max.	11 ms			
Line frequency range	47...63 Hz			
Isolation volt. between input/output	4.000 V			
Isolation volt. between input-output/base	2.500 V			
Isolation resistance	50 MΩ			
Operation temperature	-20...+80 °C			
Recommended varistor	SIOV-S20 K420			
Approvals	UL, VDE			



### Features

- Switching** Zero cross
- Output** Back to back SCR with internal snubber
- Input** DC with constant current control
- Applications** Inductive loads

### Technical data

WG 480 D...	10 R	25 R	40 R	50 R
<b>Input circuit</b>				
Control voltage range	3...32 VDC			
Control current max.	22 mA			
Turn-off voltage min.	1 VDC			
Input resistance	constant current			
<b>Output circuit</b>				
Load voltage range	48...530 VAC			
Peak-off state voltage	1200 V <sub>drm</sub> (integrated overvoltage protection effective above 1000V)			
Off-state leakage current	10 mA eff.			
Load current range	0,1...10 A	0,2...25 A	0,4...40 A	0,4...50 A
Surge current 1 half wave	110 A <sub>peak</sub>	230 A <sub>peak</sub>	500 A <sub>peak</sub>	570 A <sub>peak</sub>
I <sup>2</sup> t for fusing	60 A <sup>2</sup> s	260 A <sup>2</sup> s	1250 A <sup>2</sup> s	1620 A <sup>2</sup> s
On-state voltage	1,6 V <sub>peak</sub>			
Off-state (static) dV/dt	500 V/μs			
Snubber	47 Ω / 22 nF			
<b>General data</b>				
Turn-on time max.	0,1 ms			
Turn-off time max.	11 ms			
Line frequency range	47...63 Hz			
Isolation volt. between input/output	4.000 V			
Isolation volt. between input-output/base	2.500 V			
Isolation resistance	50 MΩ			
Operation temperature	-20...+80 °C			
Recommended varistor	SIOV-S20 K420			
Approvals	UL, VDE			

Technical data				
WG 480 D...	75 R	90 R	110 R	125 R
<b>Input circuit</b>				
Control voltage range	3...32 VDC			
Control current max.	22 mA			
Turn-off voltage min.	1 VDC			
Input resistance	constant current			
<b>Output circuit</b>				
Load voltage range	48...530 VAC			
Peak-off state voltage	1200 V <sub>drm</sub> (integrated overvoltage protection effective above 1000V)			
Off-state leakage current	10 mA eff.			
Load current range	0,4...75 A	0,4...90 A	0,4...110 A	0,4...125 A
Surge current 1 half wave	910 A <sub>peak</sub>	1090 A <sub>peak</sub>	1350 A <sub>peak</sub>	1590 A <sub>peak</sub>
I <sup>2</sup> t for fusing	4150 A <sup>2</sup> s	5980 A <sup>2</sup> s	9100 A <sup>2</sup> s	12650 A <sup>2</sup> s
On-state voltage	1,6 V <sub>peak</sub>			
Off-state (static) dV/dt	500 V/μs			
Snubber	47 Ω / 22 nF			
<b>General data</b>				
Turn-on time max.	0,1 ms			
Turn-off time max.	11 ms			
Line frequency range	47...63 Hz			
Isolation volt. between input/output	4.000 V			
Isolation volt. between input-output/base	2.500 V			
Isolation resistance	50 MΩ			
Operation temperature	-20...+80 °C			
Recommended varistor	SIOV-S20 K420			
Approvals	UL, VDE			

### Dimensions in mm & circuit diagram

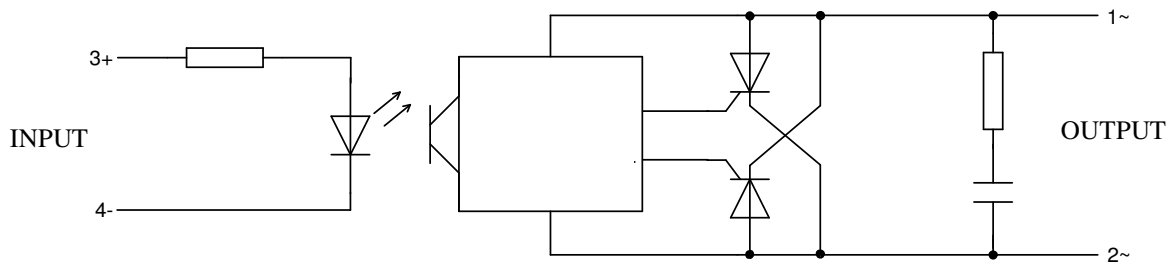
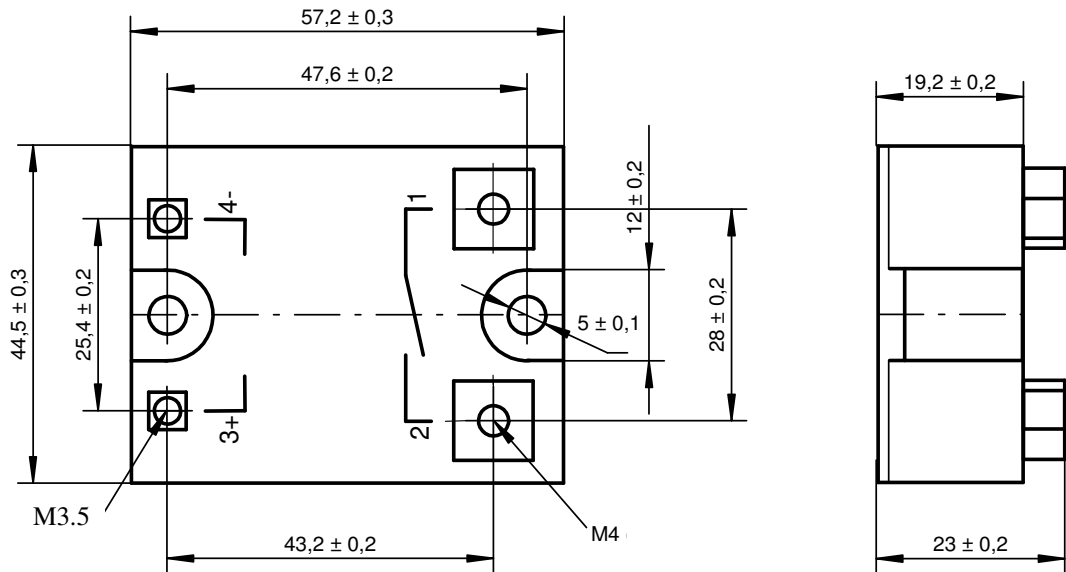

### Housing specification

Weight	Approx. 80 gr unpotted , 100 gr potted (optional)
Housing material	Glass filled polyester
Potting compound (optional)	UL recognized Epoxy
Base plate	10 ... 45 A : Aluminium 50 ... 125A : Aluminium , nickel plated
Terminals	Input : M3,5-screws Output : M4-screws

### Derating-diagrams

UL recognised components: suitable for a max. surrounding air temperature of 40°C.  
 For use at other ambient temperatures, check the derating diagrams.

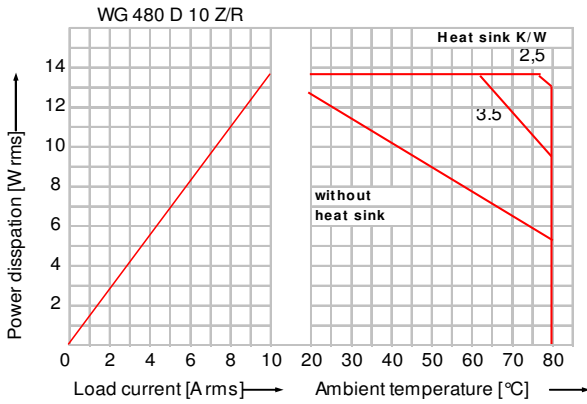

**Number of SSR per heatsink/  
load current per SSR**

Heat sink	1 SSR	2 SSR	3 SSR
WG K1/100	10 A	8 A	
WG K2/100	10 A	10 A	
WG K3/160	10 A	10 A	10 A
WG K4/160L	10 A	10 A	10 A
WG K5/80	10 A		

Values for 40°C enclosure-temperature and mounted with conduction paste between the SSR and the heat sink

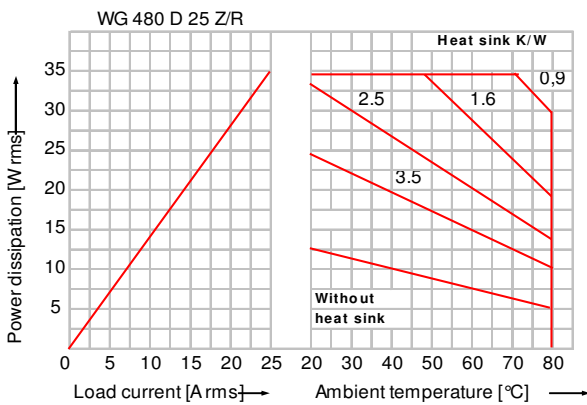

**Number of SSR per heatsink/  
load current per SSR**

Heat sink	1 SSR	2 SSR	3 SSR
WG K1/100	13 A	8 A	
WG K2/100	19 A	12 A	
WG K3/160	25 A	25 A	19 A
WG K4/160L	25 A	25 A	25 A
WG K5/80	24 A		

Values for 40°C enclosure-temperature and mounted with conduction paste between the SSR and the heat sink

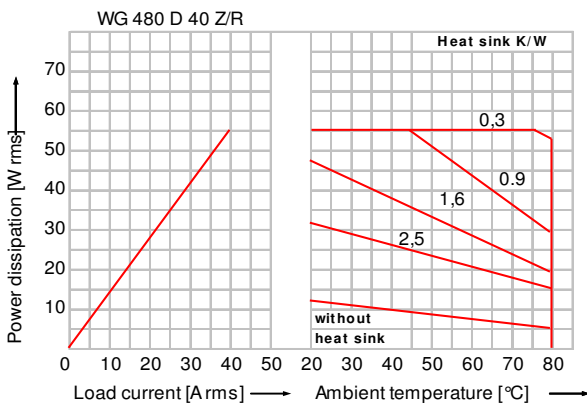

**Number of SSR per heatsink/  
load current per SSR**

Heat sink	1 SSR	2 SSR	3 SSR
WG K1/100	13 A	8 A	
WG K2/100	19 A	12 A	
WG K3/160	42 A	26 A	19 A
WG K4/160L	45 A	45 A	40 A
WG K5/80	24 A		

Values for 40°C enclosure-temperature and mounted with conduction paste between the SSR and the heat sink

### Derating-diagrams

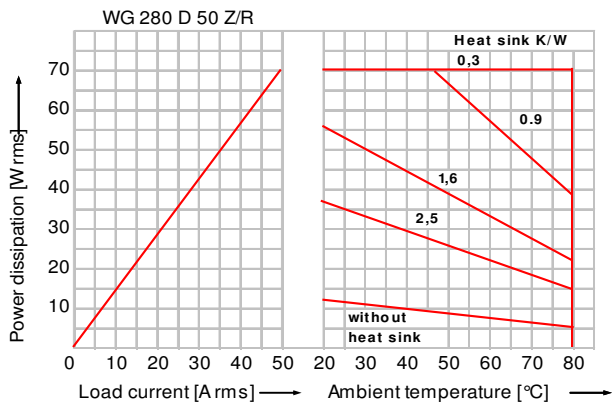

Heat sink	Number of SSR per heatsink/ load current per SSR		
	1 SSR	2 SSR	3 SSR
WG K1/100	13 A	8 A	
WG K2/100	20 A	12 A	
WG K3/160	50 A	31 A	20 A
WG K4/160L	50 A	50 A	50 A
WG K5/80	25 A		

Values for 40°C enclosure-temperature and mounted with conduction paste between the SSR and the heat sink

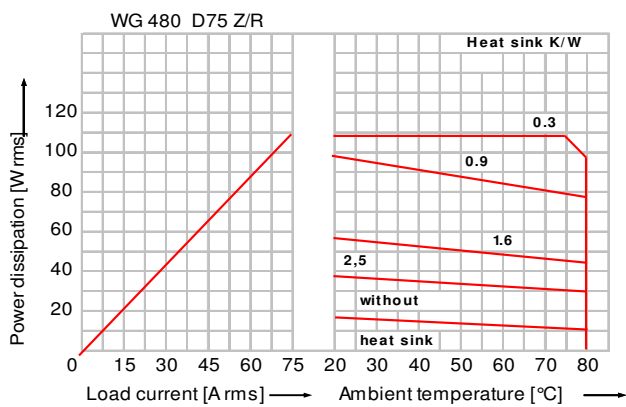

Heat sink	Number of SSR per heatsink/ load current per SSR		
	1 SSR	2 SSR	3 SSR
WG K1/100	13 A	8 A	
WG K2/100	20 A	12 A	
WG K3/160	55 A	32 A	20 A
WG K4/160L	75 A	75 A	57 A
WG K5/80	25 A		

Values for 40°C enclosure-temperature and mounted with conduction paste between the SSR and the heat sink

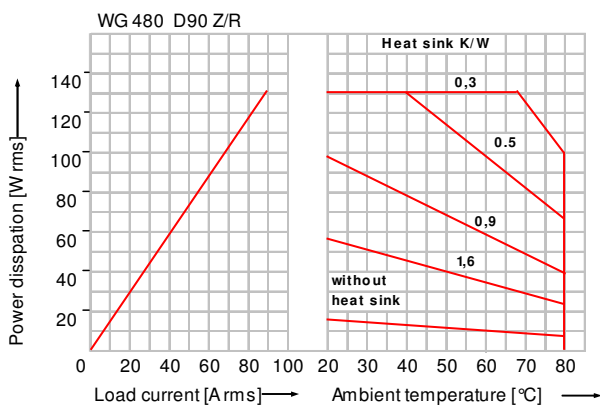

Heat sink	Number of SSR per heatsink/ load current per SSR		
	1 SSR	2 SSR	3 SSR
WG K1/100	13 A	8 A	
WG K2/100	20 A	12 A	
WG K3/160	55 A	32 A	20 A
WG K4/160L	90 A	90 A	57 A
WG K5/80	25 A		

Values for 40°C enclosure-temperature and mounted with conduction paste between the SSR and the heat sink

### Derating-Diagrams

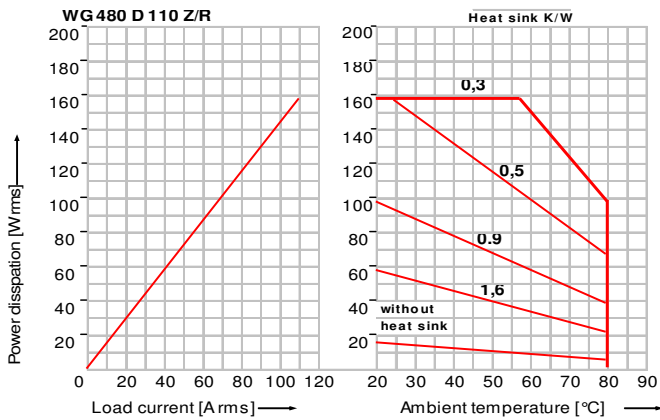

Number of SSR per heatsink/  
load current per SSR

Heat sink	1 SSR	2 SSR
WG K1/100	13 A	8 A
WG K2/100	21 A	12 A
WG K3/160	58 A	30 A
WG K4/160L	110 A	85 A
WG K5/80	34 A	

Values for 40°C enclosure-temperature and mounted with conduction paste between the SSR and the heat sink

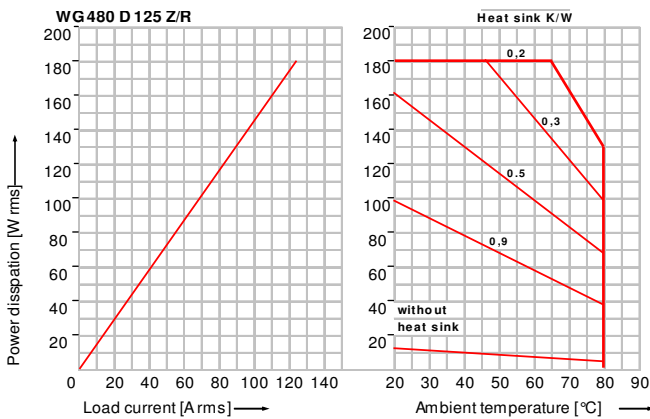

Number of SSR per heatsink/  
load current per SSR

Heat sink	1 SSR	2 SSR
WG K1/100	13 A	8 A
WG K2/100	21 A	12 A
WG K3/160	58 A	33 A
WG K4/160L	125 A	85 A
WG K5/80	34 A	

Values for 40°C enclosure-temperature and mounted with conduction paste between the SSR and the heat sink

### Ordering

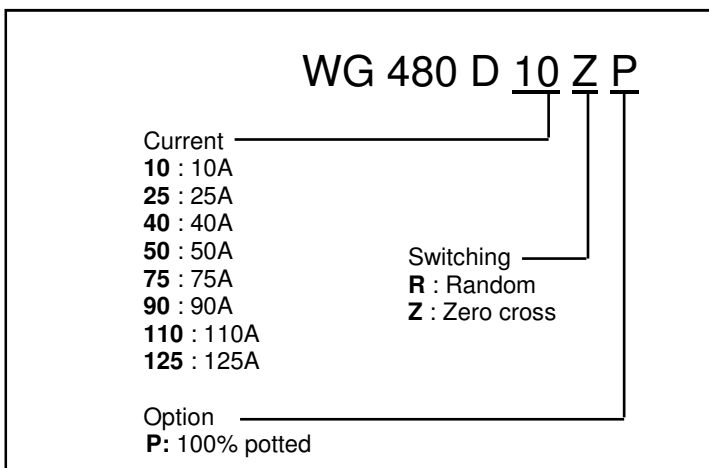

Description	Part Number
Protective case small	8440 5700 110
Thermal Conducting paste	8406 0180 020
Heat sink WG K1/100	5981 5701 100
Heat sink WG K2/100	5981 5701 110
Heat sink WG K3/160	5981 5701 370
Heat sink WG K4/160L	5981 5701 371
Heat sink WG K5/80	5981 5701 372
Mounting plate DIN rail	5981 5701 430



# Solid State Relays

## Datasheet WG 660 D...Z

Comus International Bvba  
 Overhaamlaan 40  
 3700 Tongeren, Belgium  
 Phone: +32 12390400  
 Fax: +32 12235754  
 Email: info@comus.be  
 www.comus.be



### Features

- Switching** Zero cross
- Output** Back to back SCR with internal snubber
- Input** DC with constant current control
- Applications** Resistive and inductive loads with  $\cos\phi > 0.85$

### Technical data

WG 660 D...	10 Z	25 Z	40 Z	50 Z
<b>Input circuit</b>				
Control voltage range	3...32 VDC			
Control current max.	22 mA			
Turn-off voltage min.	1 VDC			
Input resistance	constant current			
<b>Output circuit</b>				
Load voltage range	24...660 VAC			
Peak-off state voltage	1600 V <sub>drm</sub> (integrated overvoltage protection effective above 1200V)			
Off-state leakage current	10 mA eff.			
Load current range	0,1...10 A	0,2...25 A	0,4...40 A	0,4...50 A
Surge current 1 half wave	110 A <sub>peak</sub>	230 A <sub>peak</sub>	500 A <sub>peak</sub>	570 A <sub>peak</sub>
I <sup>2</sup> t for fusing	60 A <sup>2</sup> s	260 A <sup>2</sup> s	1250 A <sup>2</sup> s	1620 A <sup>2</sup> s
On-state voltage	1,6 V <sub>peak</sub>			
Off-state (static) dV/dt	500 V/μs			
Snubber	47 Ω / 5 nF			
<b>General data</b>				
Turn-on time max.	11 ms			
Turn-off time max.	11 ms			
Line frequency range	47...63 Hz			
Isolation volt. between input/output	4.000 V			
Isolation volt. between input-output/base	2.500 V			
Isolation resistance	50 MΩ			
Operation temperature	-20...+80 °C			
Recommended varistor	SIOV-S20 K625			
Approvals	UL, VDE			

Technical data				
WG 660 D...	75 Z	90 Z	110 Z	125 Z
<b>Input circuit</b>				
Control voltage range	3...32 VDC			
Control current max.	22 mA			
Turn-off voltage min.	1 VDC			
Input resistance	constant current			
<b>Output circuit</b>				
Load voltage range	24...660 VAC			
Peak-off state voltage	1600 V <sub>drm</sub> (integrated overvoltage protection effective above 1200V)			
Off-state leakage current	10 mA eff.			
Load current range	0,4...75 A	0,4...90 A	0,4...110 A	0,4...125 A
Surge current 1 half wave	910 A <sub>peak</sub>	1090 A <sub>peak</sub>	1350 A <sub>peak</sub>	1590 A <sub>peak</sub>
I <sup>2</sup> t for fusing	4150 A <sup>2</sup> s	5980 A <sup>2</sup> s	9100 A <sup>2</sup> s	12650 A <sup>2</sup> s
On-state voltage	1,6 V <sub>peak</sub>			
Off-state (static) dV/dt	500 V/μs			
Snubber	47 Ω / 5 nF			
<b>General data</b>				
Turn-on time max.	11 ms			
Turn-off time max.	11 ms			
Line frequency range	47...63 Hz			
Isolation volt. between input/output	4.000 V			
Isolation volt. between input-output/base	2.500 V			
Isolation resistance	50 MΩ			
Operation temperature	-20...+80 °C			
Recommended varistor	SIOV-S20 K625			
Approvals	UL, VDE			



### Features

- Switching** Zero cross
- Output** Back to back SCR with internal snubber
- Input** DC with constant current control
- Applications** Inductive loads

### Technical data

WG 660 D...	10 R	25 R	40 R	50 R
<b>Input circuit</b>				
Control voltage range	3...32 VDC			
Control current max.	22 mA			
Turn-off voltage min.	1 VDC			
Input resistance	constant current			
<b>Output circuit</b>				
Load voltage range	48...660 VAC			
Peak-off state voltage	1600 V <sub>drm</sub> (integrated overvoltage protection effective above 1200V)			
Off-state leakage current	10 mA eff.			
Load current range	0,1...10 A	0,2...25 A	0,4...40 A	0,4...50 A
Surge current 1 half wave	110 A <sub>peak</sub>	230 A <sub>peak</sub>	500 A <sub>peak</sub>	570 A <sub>peak</sub>
I <sup>2</sup> t for fusing	60 A <sup>2</sup> s	260 A <sup>2</sup> s	1250 A <sup>2</sup> s	1620 A <sup>2</sup> s
On-state voltage	1,6 V <sub>peak</sub>			
Off-state (static) dV/dt	500 V/μs			
Snubber	47 Ω / 5 nF			
<b>General data</b>				
Turn-on time max.	0,1 ms			
Turn-off time max.	11 ms			
Line frequency range	47...63 Hz			
Isolation volt. between input/output	4.000 V			
Isolation volt. between input-output/base	2.500 V			
Isolation resistance	50 MΩ			
Operation temperature	-20...+80 °C			
Recommended varistor	SIOV-S20 K625			
Approvals	UL, VDE			

Technical data				
WG 660 D...	75 R	90 R	110 R	125 R
<b>Input circuit</b>				
Control voltage range	3...32 VDC			
Control current max.	22 mA			
Turn-off voltage min.	1 VDC			
Input resistance	constant current			
<b>Output circuit</b>				
Load voltage range	48...660 VAC			
Peak-off state voltage	1600 V <sub>drm</sub> (integrated overvoltage protection effective above 1200V)			
Off-state leakage current	10 mA eff.			
Load current range	0,4...75 A	0,4...90 A	0,4...110 A	0,4...125 A
Surge current 1 half wave	910 A <sub>peak</sub>	1090 A <sub>peak</sub>	1350 A <sub>peak</sub>	1590 A <sub>peak</sub>
I <sup>2</sup> t for fusing	4150 A <sup>2</sup> s	5980 A <sup>2</sup> s	9100 A <sup>2</sup> s	12650 A <sup>2</sup> s
On-state voltage	1,6 V <sub>peak</sub>			
Off-state (static) dV/dt	500 V/μs			
Snubber	47 Ω / 5 nF			
<b>General data</b>				
Turn-on time max.	0,1 ms			
Turn-off time max.	11 ms			
Line frequency range	47...63 Hz			
Isolation volt. between input/output	4.000 V			
Isolation volt. between input-output/base	2.500 V			
Isolation resistance	50 MΩ			
Operation temperature	-20...+80 °C			
Recommended varistor	SIOV-S20 K625			
Approvals	UL, VDE			

### Dimensions in mm & circuit diagram

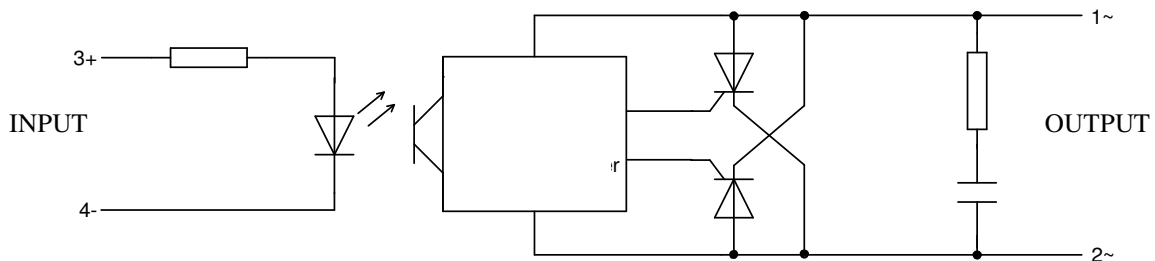
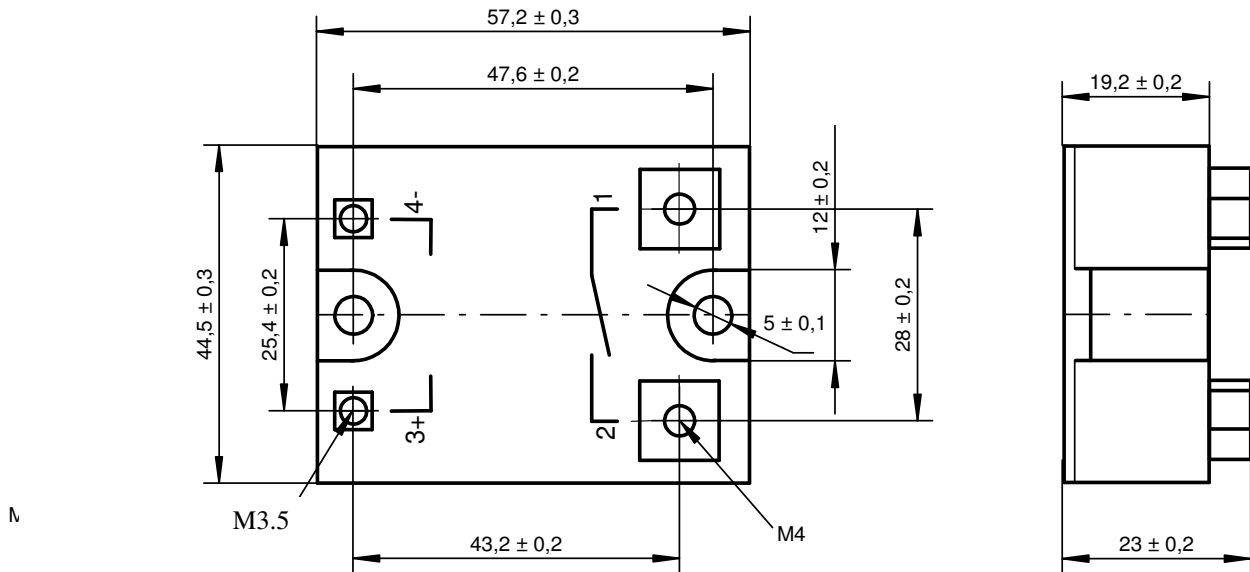

### Housing specification

Weight	Approx. 80 gr unpotted , 100 gr potted (optional)
Housing material	Glass filled polyester
Potting compound (optional)	UL recognized Epoxy
Base plate	10 ... 45 A : Aluminium 50 ... 125A : Aluminium , nickel plated
Terminals	Input : M3,5-screws Output : M4-screws

### Derating-diagrams

UL recognised components: suitable for a max. surrounding air temperature of 40°C.  
 For use at other ambient temperatures, check the derating diagrams.

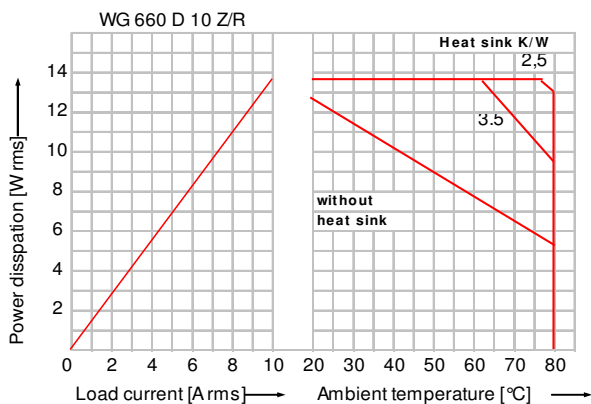

**Number of SSR per heatsink/  
load current per SSR**

Heat sink	1 SSR	2 SSR	3 SSR
WG K1/100	10 A	8 A	
WG K2/100	10 A	10 A	
WG K3/160	10 A	10 A	10 A
WG K4/160L	10 A	10 A	10 A
WG K5/80	10 A		

Values for 40°C enclosure-temperature and mounted with conduction paste between the SSR and the heat sink

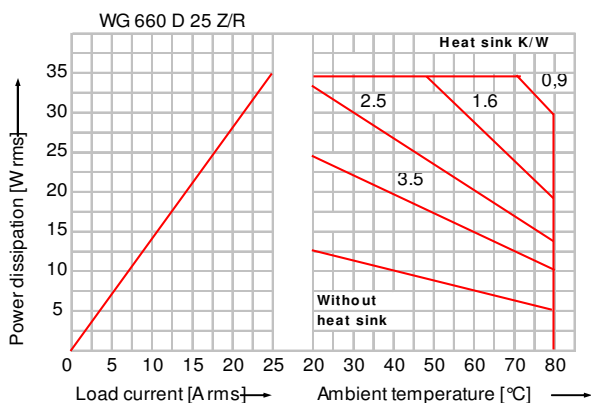

**Number of SSR per heatsink/  
load current per SSR**

Heat sink	1 SSR	2 SSR	3 SSR
WG K1/100	13 A	8 A	
WG K2/100	19 A	12 A	
WG K3/160	25 A	25 A	19 A
WG K4/160L	25 A	25 A	25 A
WG K5/80	24 A		

Values for 40°C enclosure-temperature and mounted with conduction paste between the SSR and the heat sink

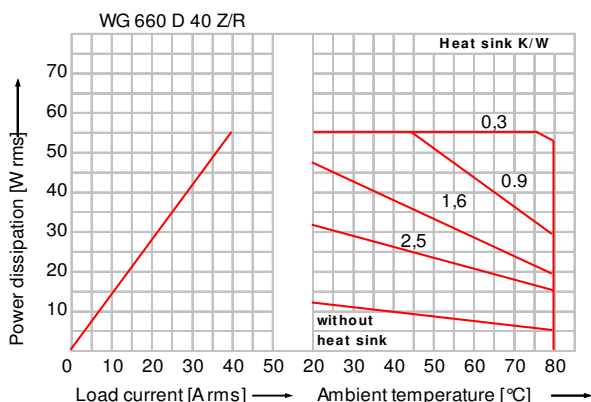

**Number of SSR per heatsink/  
load current per SSR**

Heat sink	1 SSR	2 SSR	3 SSR
WG K1/100	13 A	8 A	
WG K2/100	19 A	12 A	
WG K3/160	42 A	26 A	19 A
WG K4/160L	45 A	45 A	40 A
WG K5/80	24 A		

Values for 40°C enclosure-temperature and mounted with conduction paste between the SSR and the heat sink

### Derating-diagrams

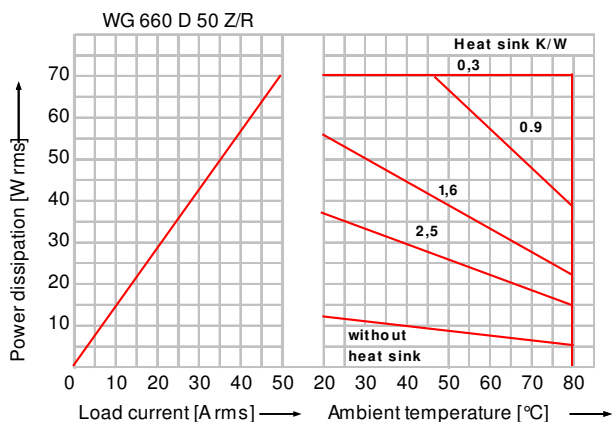

Number of SSR per heatsink/  
load current per SSR

Heat sink	1 SSR	2 SSR	3 SSR
WG K1/100	13 A	8 A	
WG K2/100	20 A	12 A	
WG K3/160	50 A	31 A	20 A
WG K4/160L	50 A	50 A	50 A
WG K5/80	25 A		

Values for 40°C enclosure-temperature and mounted with conduction paste between the SSR and the heat sink

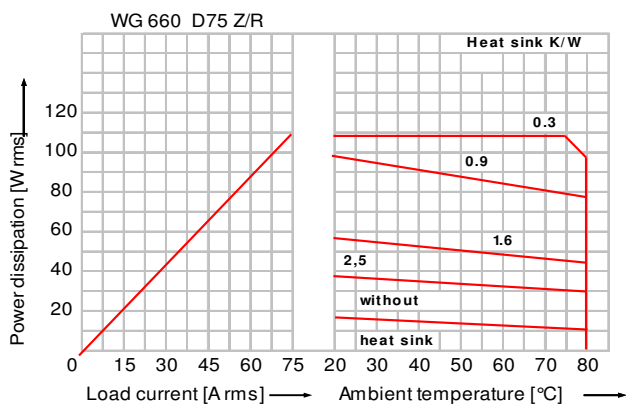

Number of SSR per heatsink/  
load current per SSR

Heat sink	1 SSR	2 SSR	3 SSR
WG K1/100	13 A	8 A	
WG K2/100	20 A	12 A	
WG K3/160	55 A	32 A	20 A
WG K4/160L	75 A	75 A	57 A
WG K5/80	25 A		

Values for 40°C enclosure-temperature and mounted with conduction paste between the SSR and the heat sink

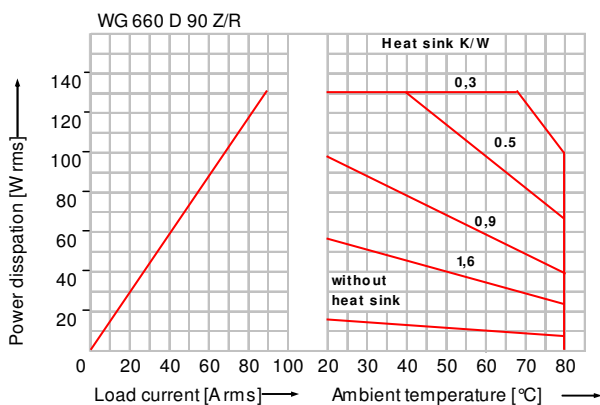

Number of SSR per heatsink/  
load current per SSR

Heat sink	1 SSR	2 SSR	3 SSR
WG K1/100	13 A	8 A	
WG K2/100	20 A	12 A	
WG K3/160	55 A	32 A	20 A
WG K4/160L	90 A	90 A	57 A
WG K5/80	25 A		

Values for 40°C enclosure-temperature and mounted with conduction paste between the SSR and the heat sink

### Derating-diagrams

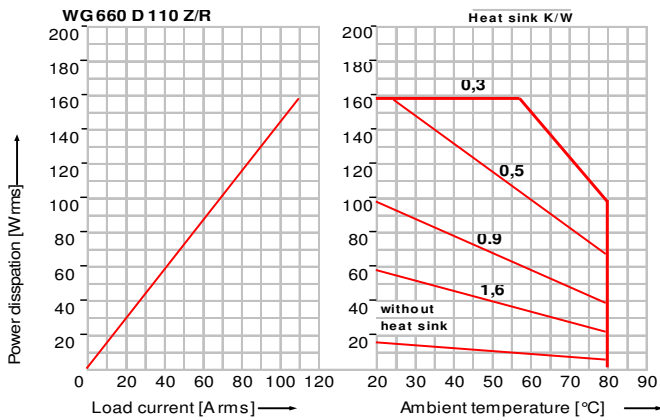

Number of SSR per heatsink/  
load current per SSR

Heat sink	1 SSR	2 SSR
WG K1/100	13 A	8 A
WG K2/100	21 A	12 A
WG K3/160	58 A	33 A
WG K4/160L	110 A	85 A
WG K5/80	34 A	

Values for 40°C enclosure-temperature and mounted with Conduction paste between the SSR and the heat sink

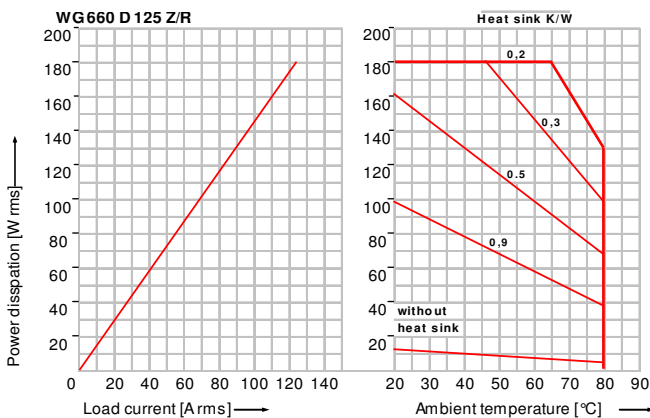

Number of SSR per heatsink/  
load current per SSR

Heat sink	1 SSR	2 SSR
WG K1/100	13 A	8 A
WG K2/100	21 A	12 A
WG K3/160	58 A	33 A
WG K4/160L	125 A	85 A
WG K5/80	34 A	

Values for 40°C enclosure-temperature and mounted with Conduction paste between the SSR and the heat sink

### Ordering

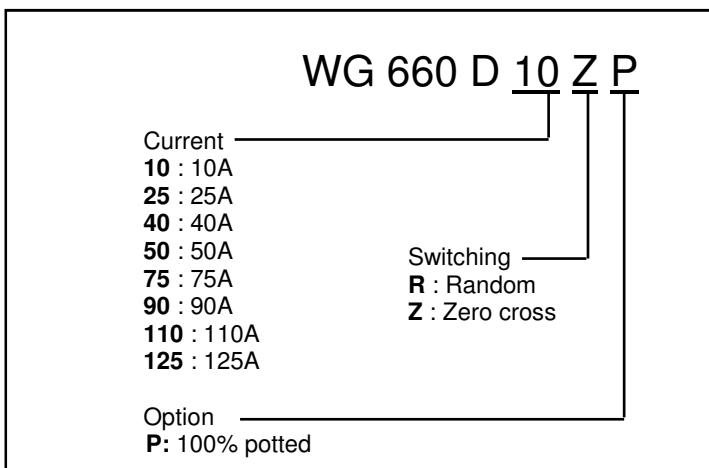

Description	Part Number
Protective case small	8440 5700 110
Thermal conducting paste	8406 0180 020
Heat sink WG K1/100	5981 5701 100
Heat sink WG K2/100	5981 5701 110
Heat sink WG K3/160	5981 5701 370
Heat sink WG K4/160L	5981 5701 371
Heat sink WG K5/80	5981 5701 372
Mounting plate DIN rail	5981 5701 430