

Absolute Maximum Ratings

symbol	Parameter	Value	Unit
V_{GE}	Gate-Emitter Voltage	40	V
I_C	Collector Current (continuous) at $T_C = 25^\circ\text{C}$	30	A
	Collector Current (continuous) at $T_C = 100^\circ\text{C}$	15	A
$I_{CM(1)}$	Collector Current (pulsed)	45	A
E_{as}	Single Pulse Energy $T_C = 25^\circ\text{C}$	500	mJ
P_{TOT}	Total Dissipation at $T_C = 25^\circ\text{C}$	150	W
E_{SD}	ESD (Human Body Model)	3	KV
T_{stg}	Storage Temperature	- 55 to 150	$^\circ\text{C}$
T_j	Max. Operating Junction Temperature		

(1)Pulse width limited by safe operating area

Thermal Characteristics

Symbol	Parameter	Value			Unit
		Min	Typ	Max	
R_{QJC}	Thermal Resistance , Junction -to -Case	-	-	0.75	$^\circ\text{C/W}$
R_{QJA}	Thermal Resistance , Junction-to -Ambient	-	-	62.5	$^\circ\text{C/W}$

Electrical Characteristics ($T_{CASE} = 25^\circ\text{C}$ UNLESS OTHERWISE SPECIFIED)

Symbol	Parameter	Test Conditions	Min	Typ	Max	Unit
$BV_{(CES)}$	Clamped Voltage	$I_C = 1\text{mA}, V_{GE} = 0, T_C = 25^\circ\text{C}$	650	-	-	V
$BV_{(ECR)}$	Emitter Collector Break-down Voltage	$I_C = 75\text{mA}, T_C = 25^\circ\text{C}$	20	30	-	V
I_{CES}	Collector cut-off Current ($V_{GE} = 0$)	$V_{CE} = 620\text{V}, V_{GE} = 0, T_C = 25^\circ\text{C}$	-	5	-	μA
I_{GES}	Gate-Emitter Leakage Current ($V_{CE} = 0$)	$V_{GE} = \pm 10\text{V}, V_{CE} = 0$	-	± 100	-	μA
$V_{GE(th)}$	Gate Threshold Voltage	$V_{CE} = V_{GE}, I_C = 250\mu\text{A}, T_C = -50^\circ\text{C}$	2	3.18	4	V
		$V_{CE} = V_{GE}, I_C = 250\mu\text{A}, T_C = 25^\circ\text{C}$	1.8	3.05	3.5	V
		$V_{CE} = V_{GE}, I_C = 250\mu\text{A}, T_C = 150^\circ\text{C}$	1.5	2.11	3	V
$V_{CE(SAT)}$	Collector-Emitter Saturation Voltage	$V_{GE} = 5.5\text{V}, I_C = 5\text{A}, T_C = 25^\circ\text{C}$	-	1.03	1.2	V
		$V_{GE} = 5.5\text{V}, I_C = 5\text{A}, T_C = 150^\circ\text{C}$	-	0.92	1.2	V
		$V_{GE} = 5.5\text{V}, I_C = 10\text{A}, T_C = 25^\circ\text{C}$	-	1.5	1.7	V
		$V_{GE} = 5.5\text{V}, I_C = 10\text{A}, T_C = 150^\circ\text{C}$	-	1.32	1.5	V

Symbol	Parameter	Test Conditions	Min.	Typ.	Max.	Unit
$g_{fs(1)}$	Forward Transconductance	$V_{CE} = 25\text{V}, I_C = 10\text{A}$	25	30	-	S
C_{ies}	Input Capacitance	$V_{CE} = 25\text{V}, f = 1\text{MHz}, V_{GE} = 0$	-	1196	-	pF
C_{oes}	Output Capacitance		-	211	-	pF
C_{res}	Reverse Transfer Capacitance		-	3.3	-	pF
Q_g	Gate Charge	$V_{CE} = 280\text{V}, I_C = 10\text{A}, V_{GE} = 5\text{V}$	-	21.4	-	nC

WT-G003-Rev A0 Nov 2013

WINSEMI MICROELECTRONICS WINSEMI MICROELECTRONICS WINSEMI MICROELECTRONICS WINSEMI MICROELECTRONICS WINSEMI MICROELECTRONICS

$t_r(V_{off})$	Off Voltage Rise Time	$V_{CC} = 250V, I_C = 10A, R_{GE} = 1K\Omega, V_{GE} = 5.5V$	-	1.84	3	μs
$t_{d(off)}$	Delay Time		-	2.58	4	μs
t_f	Fall Time		-	3.32	5	μs
$E_{off} (**)$	Turn-off Switching Loss		-	7.72	11	mJ
$t_r(V_{off})$	Off Voltage Rise Time	$V_{CC} = 250V, I_C = 10A, R_{GE} = 1K\Omega, V_{GE} = 5.5V, T_j = 125^\circ C$	-	2.5	4	μs
$t_{d(off)}$	Delay Time		-	1	2	μs
t_f	Fall Time		-	4.54	6	μs
$E_{off} (**)$	Turn-off Switching Loss		-	8.63	15	mJ

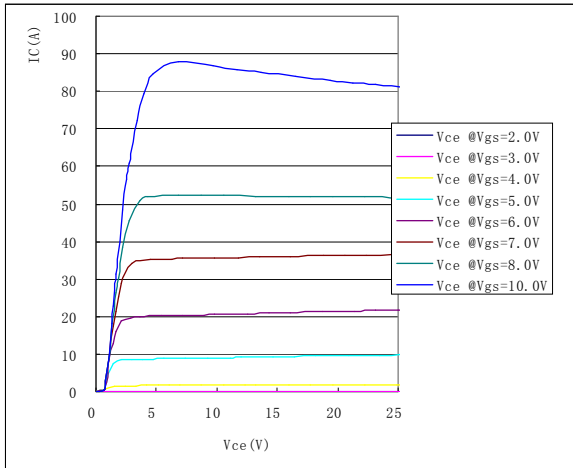

Output Characteristics

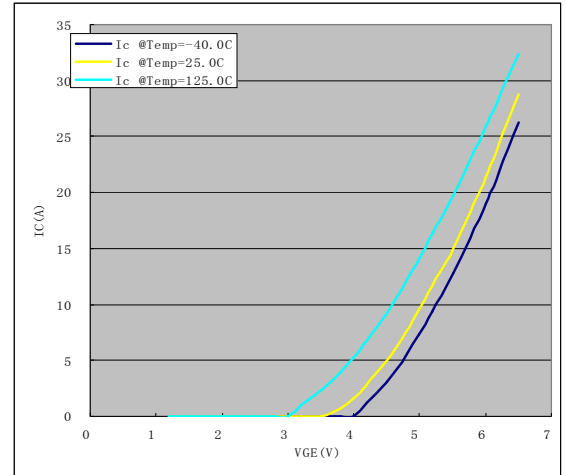

Transfer Characteristics

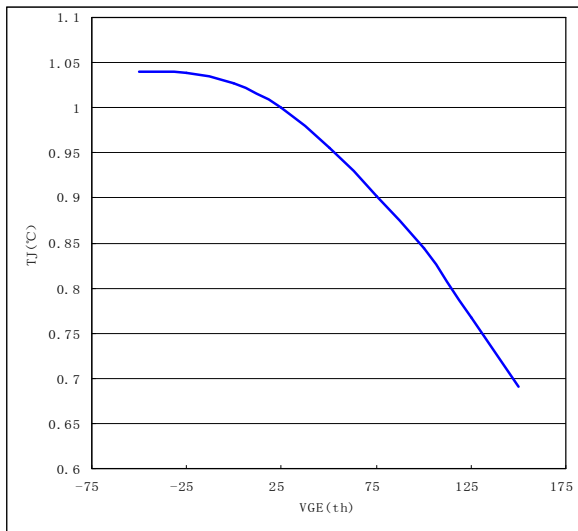

Normalized Gate Threshold Voltage vs Temp.

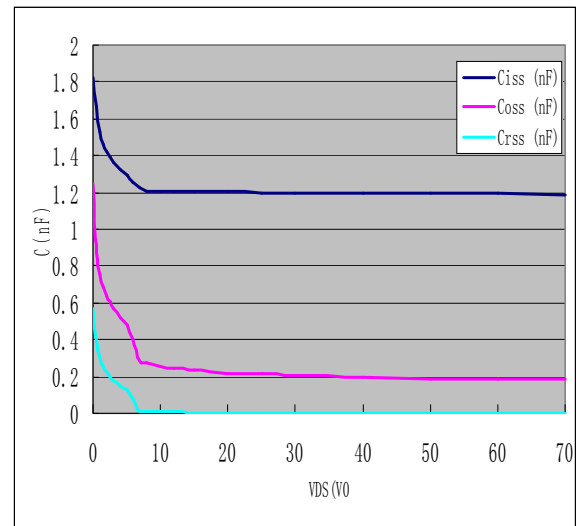

Capacitance Variations

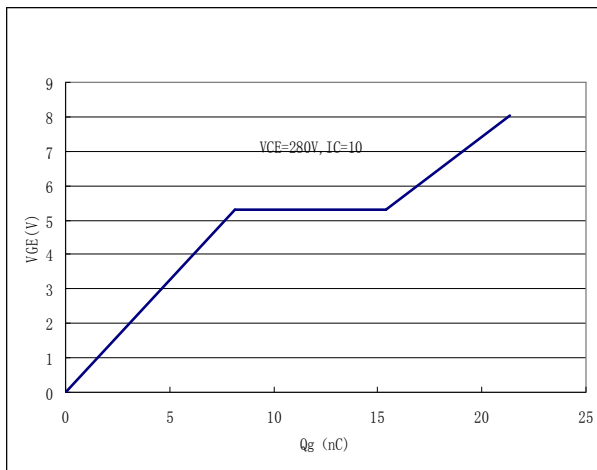

Gate Charge vs Gate-Emitter Voltage

Switching Off

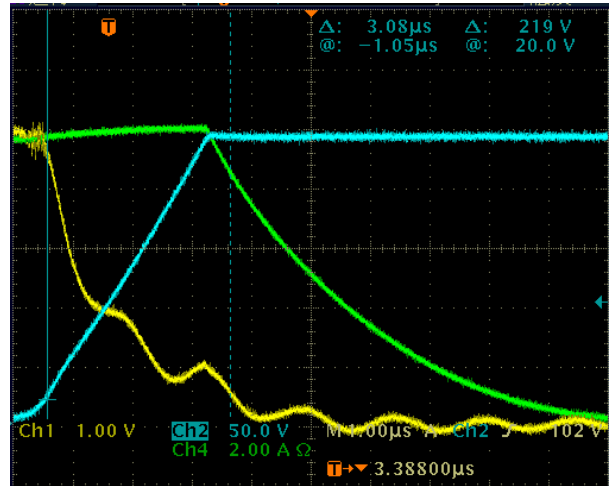
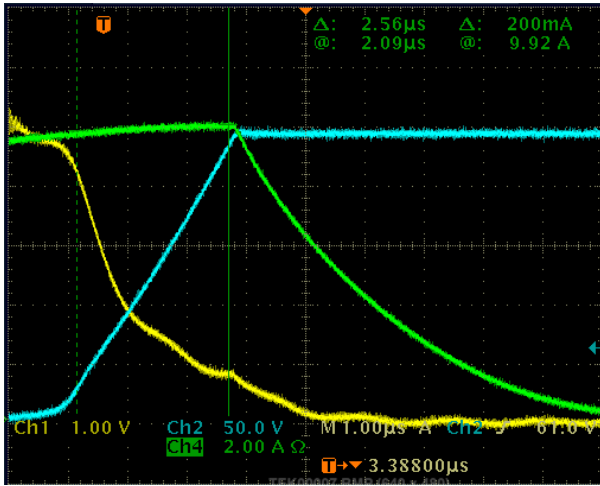

TO-220C Package Dimension

Unit:mm

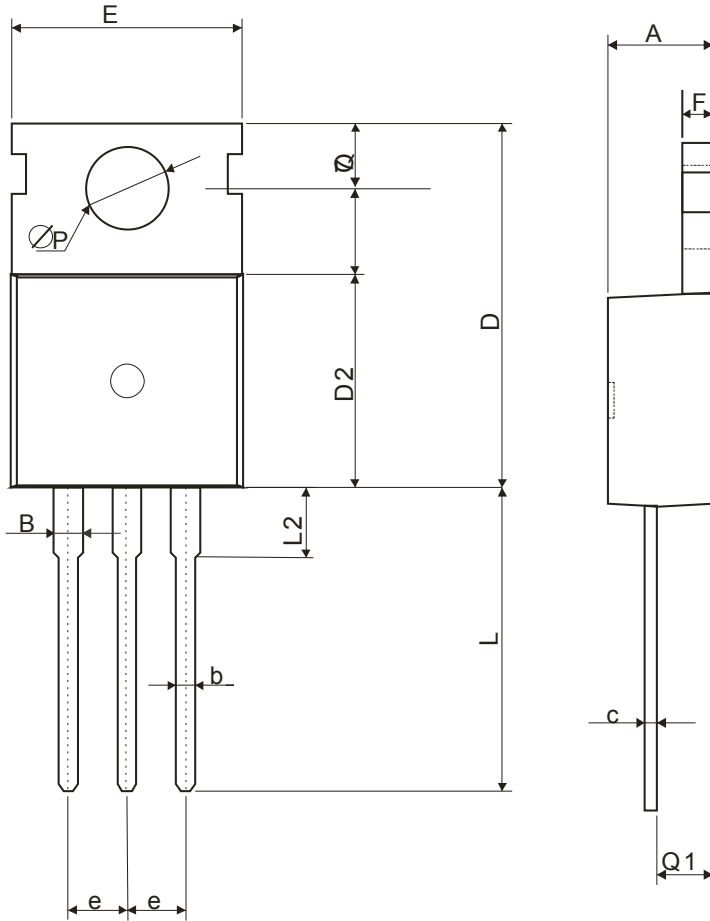

符号	MIN	MAX
A	4.30	4.70
B	1.10	1.40
b	0.70	0.95
c	0.40	0.65
d	15.2	16.2
D2	9.00	9.40
E	9.70	10.10
e	2.39	2.69
F	1.25	1.40
L	12.60	13.60
L2	2.80	3.20
Q	2.60	3.00
Q1	2.20	2.60
P	3.50	3.80

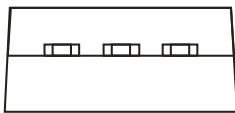

NOTE:

- 1.We strongly recommend customers check carefully on the trademark when buying our product, if there is any question, please don't be hesitate to contact us.
- 2.Please do not exceed the absolute maximum ratings of the device when circuit designing.
- 3.Winsemi Microelectronics Co., Ltd reserved the right to make changes in this specification sheet and is subject to change without prior notice.

CONTACT:

Winsemi Microelectronics Co., Ltd.

ADD:Futian District, ShenZhen Tian An Cyber Tech Plaza two East Wing 1002

Post Code : 518040

Tel : 86-0755-82506257

FAX : 86-0755-82506299

Web Site : www.winsemi.com